

# Catálogo de accesorios Náuticos



**2025**

El Navegante

[www.repuestoselnavegante.com](http://www.repuestoselnavegante.com)



Bi-Color Bow Lights

Marpac L.E.D. Bi-Color Bow Light



- Epoxy coated electronics encased in corrosion proof composite case protected by a tough Nichromium shell.
- For use on boats up to 39.4' (12 meters).
- 2 mile visibility.
- #8 pan head screws hidden from view (Not included).
- Dimensions: 3-1/4" L x 2-5/8" W.
- No bulbs to replace - LED's are Surface Mounted Diodes (SMB). 12 volt.

Order No.	Description	List Price	
7-6598	LED Bi-Color Bow Light	\$66.79	GO-5744000

Marpac L.E.D. Bi-Color Bow Light



- Stainless steel cover.
- Water resistant. IP67 - completely sealed
- Dimensions: 3.37" L x 2.70" W x 1.50" D.
- No bulbs to replace - LED's are Surface Mounted Diodes (SMB).
- Meets ABYC-A16/USCG 2 NM.
- 12 volt.

Order No.	Description	List Price	
7-6600	LED Bi-Color Bow Light	\$26.99	GO-8081000

**NEW PRODUCT**

Perko Fig. 615 L.E.D. Bi-Color Light



- Polished stainless steel.
- Ultra low profile, low heat, long life.
- 2 mile visibility.
- Use on power driven vessels under 20 meters in length.
- Length 2-1/2", width 2-5/8", height 5/8".
- Uses #8 fasteners.
- 12 volt. 3.75 watts.

Order No.	Mfg. No. / Description	List Price	
544519	(0615 DP2 STS)	\$142.49	FO-4799000

Marpac Bi-Color Combination Bow Light



- Chrome plated finish.
- 1 mile visibility.
- For use on boats up to 39.4' (12 meters).
- Dimensions: 4" L x 3-1/8" W x 1-7/8" H.
- Uses #8 fasteners (Not included).
- #71 12 volt bulb (Included).
- 5 year warranty. Made in the USA.

Order No.	Description	List Price	
7-0375	Bow Light	\$49.69	GO-9233000

**LIMITED QUANTITIES**

Marpac Bi-Color Combination Bow Light

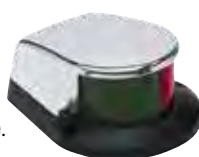

- Chrome plated finish with a low profile black plastic base.
- 1 mile visibility, 225°.
- For use on boats up to 39.4' (12 meters).
- Mounts with two #8 countersunk screws.
- Dimensions: 4-1/16" L x 3-3/8" W x 1-11/16" H.
- Uses (2) #8 fasteners (Not included).
- Uses 12 volt festoon bulb (Not included).

Order No.	Description	List Price	
7-6542	Bow Light	\$10.09	GO-6760000

Marpac Bi-Color Combination Bow Light



- Chrome plated finish.
- 1 mile visibility, 225°.
- For use on boats up to 39.4' (12 meters).
- Dimensions: 3" L x 2-1/2" W x 1-3/8" H.
- Uses (2) #8 fasteners (Not included).
- #90 12 volt bulb (Included).

Order No.	Description	List Price	
7-0841	Bow Light	\$13.49	GO-4090000
7-3936	Spare Bulbs	\$5.49	FO-4830000

Marpac L.E.D. Bi-Color Bow Light



- Chrome plated zamak housing.
- For use on boats up to 39.4' (12 meters).
- 1 mile visibility, 225°.
- Dimensions: 2-3/4" L x 2-1/2" W x 1-3/8" H.
- No bulbs to replace - LED's are Surface Mounted Diodes (SMB). 12 volt.

Order No.	Description	List Price	
7-0840	LED Bi-Color Bow Light	\$35.49	GO-8732000

Attwood LightArmor™ L.E.D. Bi-Color Lights



- 2 mile visibility.
- For use on boats up to 65.6' (20 meters) in length.
- Diameter 2.39", height 1.17".
- Sold per pair.

Order No.	Mfg. No. / Description	List Price	
233508	(NV2002SS-7) S.S.	\$59.89	FO-2914000
233510	(NV2002PB-7) Black	\$49.29	FO-0543000

Marpac Bi-Color Combination Bow Light



- Polished stainless steel housing.
- 1 mile visibility, 225°.
- Diameter 2-3/8".
- For use on boats up to 39.4' (12 meters).
- Uses (3) #4 fasteners (Included).
- #90 12 volt bulb (Included).

Order No.	Description	List Price	
7-0080	Bow Light	\$18.09	GO-2121000
7-3936	Spare Bulbs	\$5.49	FO-4830000

**LIMITED QUANTITIES**

Perko Fig. 252 Bi-Color Light - Horizontal Mount



- Black bronze top with black polymer base.
- 2 mile visibility.
- Use on power driven vessels under 20 meters in length.
- Length 3-1/2", width 2-1/4", height 1-5/8".
- Uses #8 fasteners.
- #71 12 volt bulb included. 10 watts.

Order No.	Mfg. No. / Description	List Price	
534378	(0252 BBO DP1)	\$40.99	FO-9682000

- Electronics
- Trolling Motors
- Instruments
- Electrical
- Lighting
- Anchor & Dock
- Safety
- Steering, Controls
- Pumps
- Fuel System
- Seating & Pedestals
- Trailering
- Tops & Covers
- Perform.
- Propellers
- Engine & Care
- Cleaning & Care
- Paint & Paint Acc.
- Fun & Flotation
- Topside Acc.
- Cockpit & Deck
- Hardware, Fasteners
- Camouflage
- Misc.
- Comm.

Bi-Color Bow Lights

Perko Fig. 227 Bi-Color Light - Horizontal Mount



- Chrome plated zinc alloy top with black polymer base.
- Gold plated contacts.
- 2 mile visibility.
- Use on power driven vessels under 20 meters in length
- Length 3-1/4", width 2-1/4", height 1-1/2".
- Uses #6 fasteners.
- #71 12 volt bulb included. 10 watts.

Order No.	Mfg. No. / Description	List Price	
<b>535417</b>	(0227 DPO CHR)	<b>\$52.09</b>	F0-6463000
<b>541739</b>	(0071 DPO CLR) Spare Bulbs - 2 Per Pack	<b>\$14.89</b>	F0-2401000

Perko Fig. 1310 Bi-Color Light - Horizontal Mount



- Chrome plated zinc alloy top with black polymer base.
- Gold plated contacts.
- 1 mile visibility.
- Use on power driven vessels under 12 meters in length.
- Length 4", width 3-1/8", height 1-7/8".
- Uses #8 fasteners.
- #71 12 volt bulb included. 10 watts.

Order No.	Mfg. No. / Description	List Price	
<b>534380</b>	(1310 DPO CHR)	<b>\$59.79</b>	F0-5814000
<b>536764</b>	(0283 DPA LNS) Lens	<b>\$19.39</b>	F0-7531000
<b>541739</b>	(0071 DPO CLR) Spare Bulbs - 2 Per Pack	<b>\$14.89</b>	F0-2401000

Perko Fig. 904 Bi-Color Light - Horizontal Mount



- Polished stainless steel top with black polymer base.
- Gold plated contacts.
- 1 mile visibility.
- Certified for replacement use only.
- Use on sail or power driven vessels under 12 meters in length.
- Length 4-1/4", width 2-3/8", height 1-1/2".
- Uses #4 fasteners.
- #71 12 volt bulb included. 10 watts.

Order No.	Mfg. No. / Description	List Price	
<b>543379</b>	(0904 DPO STS)	<b>\$92.79</b>	F0-5946000
<b>536838</b>	(0296 DPO LNS) Lens Set	<b>\$19.39</b>	F0-7531000
<b>541739</b>	(0071 DPO CLR) Spare Bulbs - 2 Per Pack	<b>\$14.89</b>	F0-2401000

Perko Fig. 972 Bi-Color Lights - Horizontal Mount



- Polished stainless steel top with black polymer base.
- Gold plated contacts.
- 1 mile visibility.
- Use on sail or power driven vessels under 12 meters in length.
- Height 1-5/8". OD base 2-3/8".
- Uses #4 fasteners.
- #71 12 volt bulb included. 10 watts.

Order No.	Mfg. No. / Description	List Price	
<b>544127</b>	(0972 DPO STS)	<b>\$69.59</b>	F0-1784000
<b>536838</b>	(0296 DPO LNS) Lens - Old Style Open Top	<b>\$19.39</b>	F0-7531000
<b>541739</b>	(0071 DPO CLR) Spare Bulbs - 2 Per Pack	<b>\$14.89</b>	F0-2401000

Perko Fig. 1218 Bi-Color Light - Horizontal Mount



- Chrome plated zinc alloy with 3/4" ID flag staff socket.
- 1 mile visibility.
- Certified for replacement use only.
- Use on power driven vessels under 12 meters in length.
- Length 6-3/4", width 3-7/8", height 3-1/4".
- Uses #8 fasteners.
- #71 12 volt bulb included. 10 watts.

Order No.	Mfg. No. / Description	List Price	
<b>533390</b>	(1218 DPO CHR)	<b>\$75.49</b>	F0-4825000
<b>541739</b>	(0071 DPO CLR) Spare Bulbs - 2 Per Pack	<b>\$14.89</b>	F0-2401000

Attwood Pulsar 5040 Series Bi-Color Bow Light - Deck Mount



- Black.
- 1 mile, 225° visibility.
- For use on boats up to 39.4' (12 meters).
- Cover and lens conceal installation fasteners and seal water out of lamp and hull.
- Diameter 2-3/8", height 1-7/16".
- Installs with two #10 fasteners (Not included).
- Includes: 9 watt wedge base lamp (#906).
- 12 volt.

Order No.	Mfg. No. / Description	List Price	
<b>233902</b>	(5045-7)	<b>\$30.39</b>	F0-7212000

Attwood 66000 Series Bi-Color Bow Light - Deck Mount



- Constructed of corrosion resistant 304 stainless steel.
- 1 mile, 225° visibility.
- For use on boats up to 39.4' (12 meters).
- Dimensions: 2-1/2" L x 2-1/4" W x 1-1/2" H.
- Installs with three #6 fasteners (Not included).
- Includes: 7.5 watt lamp and 7" hard wire leads.
- 12 volt.

Order No.	Mfg. No. / Description	List Price	
<b>235401</b>	(66318-7)	<b>\$41.49</b>	F0-4092000
<b>7-3936</b>	Spare Bulbs, 2 Per Pack	<b>\$5.49</b>	F0-4830000

Attwood 6300 Series Bi-Color Bow Light - Deck Mount



- Die cast zamak with Perma-Plate finish.
- 1 mile, 225° visibility.
- For use on boats up to 39.4' (12 meters).
- Includes: 7.5 watt lamp and 7" hard wire leads.
- 12 volt.

Order No.	Mfg. No. / Description	List Price	
<b>235122</b>	(6375D6)	<b>\$31.29</b>	F0-0912000
<b>7-3936</b>	Spare Bulbs, 2 Per Pack	<b>\$5.49</b>	F0-4830000

Electronics  
Trolling Motors  
Instruments  
Electrical  
Lighting  
Anchor & Dock  
Safety  
Steering, Controls  
Pumps  
Fuel System  
Seating & Pedestals  
Trailering  
Tops & Covers  
Perform.  
Propellers  
Engine & Care  
Cleaning & Care  
Paint & Paint Acc.  
Fun & Flotation  
Topside Acc.  
Cockpit & Deck  
Hardware, Fasteners  
Camouflage  
Misc.  
Comm.

Side Lights - Horizontal Mount

Marpac L.E.D. Side Lights - Horizontal Mount



- Certified USCG 2nm, for use on boats under 39.4' (12 meters).
- Dimensions: 3-1/4" L x 2-3/4" W.
- Epoxy coated electronics encased in corrosion proof composite case protected by a tough Nichromium shell.
- Uses three #8 pan head screws per light (Not included).
- Meets the stringent requirements for USCG, ABYC A-16 and IMO COLREG.
- No bulbs to replace - LED's are Surface Mounted Diodes (SMB). 12 volt.
- Sold per pair - Red/Green.

Order No.	Description	List Price	
7-6555	LED Side Lights - Horizontal Mount	\$81.99	GO-3945000

Marpac L.E.D. Side Lights - Horizontal Mount



- Stainless steel cover.
- Water resistant. IP67 - completely sealed
- Dimensions: 3.37" L x 2.70" W x 1.50" D.
- No bulbs to replace - LED's are Surface Mounted Diodes (SMB).
- Meets ABYC-A16/USCG 2 NM.
- 12 volt.

**NEW PRODUCT**

Order No.	Description	List Price	
7-6605	LED Side Lights - Horizontal Mount	\$42.99	GO-0882000

T-H Marine L.E.D. Bow Lights - Horizontal Mount



- 316 stainless housing.
- Horizontal deck mount.
- 1 Nautical Mile USCG certification.
- Dimensions: 2-1/4" L x 1" W x 11/16" H.
- 12 volt.
- Sold per pair.

Order No.	Mfg. No. / Description	List Price	
642721	(LED-LPNAV-1D)	\$89.09	FO-6326000

Perko Fig. 915 Side Lights - Horizontal Mount



- Polished stainless steel top with black polymer base.
- Gold plated contacts.
- 1 mile visibility.
- Certified for replacement use only.
- Use on sail or power driven vessels under 12 meters in length.
- Length 4-1/4", width 2-3/8", height 1-1/2". Uses #4 fasteners.
- #71 12 volt bulbs included. 10 watts (each light).
- Sold per pair.

Order No.	Mfg. No. / Description	List Price	
543389	(0915 DPO STS)	\$159.69	FO-8711100
536827	(0295 DPO LNS) Lens Set - New Style Closed Top	\$19.39	FO-7531000
536737	(0281 DPA LNS) Lens Set - Old Style Open Top	\$19.39	FO-7531000
541739	(0071 DPO CLR) Spare Bulbs - 2 Per Pack	\$14.89	FO-2401000

Perko Fig. 616 L.E.D. Side Lights - Horizontal Mount



- Polished stainless steel.
- Ultra low profile, low heat, long life.
- 2 mile visibility.
- Use on power driven vessels under 20 meters in length.
- Length 2-1/2", width 2-5/8", height 5/8".
- Uses #8 fasteners.
- 12 volt. 3.75 watts (each light).
- Sold per pair.

Order No.	Mfg. No. / Description	List Price	
544533	(0616 DP2 STS)	\$255.19	FO-3687100

Attwood LightArmor™ L.E.D. Side Lights - Deck Mount



- 2 mile visibility.
- For use on boats up to 65.6' (20 meters) in length.
- Diameter 2.39", height 1.17".

Order No.	Mfg. No. / Description	List Price	
233522	(NV2012SSG-7) Stainless Steel Green Light	\$55.79	FO-5093000
233534	(NV2012SSR-7) Stainless Steel Red Light	\$55.79	FO-5093000
233546	(NV2012PBG-7) Black Composite Green Light	\$41.39	FO-7982000
233558	(NV2012PBR-7) Black Composite Red Light	\$41.39	FO-7982000

Perko Fig. 228 Side Lights - Horizontal Mount



- Chrome plated zinc alloy top with black polymer base.
- Gold plated contacts.
- 2 mile visibility.
- Use on power driven vessels under 20 meters in length.
- Length 3-1/4", width 2-1/4", height 1-1/2". Uses #6 fasteners.
- #71 12 volt bulbs included. 10 watts (each light).
- Sold per pair.

Order No.	Mfg. No. / Description	List Price	
5315112	(0228DPO CHR)	\$103.59	FO-1527000
541739	(0071 DPO CLR) Spare Bulbs - 2 Per Pack	\$14.89	FO-2401000

Perko Fig. 963 Side Lights - Horizontal Mount



- Polished stainless steel top with black polymer base.
- Gold plated contacts.
- 1 mile visibility.
- Use on sail or power driven vessels under 12 meters in length.
- Height 1-5/8". Base dimensions: 2-3/8". Uses #4 fasteners.
- #71 12 volt bulbs included. 10 watts (each light).
- Sold per pair.

Order No.	Mfg. No. / Description	List Price	
543998	(0963 DPO STS)	\$128.59	FO-1009000
536827	(0295 DPO LNS) Lens Set - New Style Closed Top	\$19.39	FO-7531000
536737	(0281 DPA LNS) Lens Set - Old Style Open Top	\$19.39	FO-7531000
541739	(0071 DPO CLR) Spare Bulbs - 2 Per Pack	\$14.89	FO-2401000

- Electronics
- Trolling Motors
- Instruments
- Lighting
- Anchor & Dock
- Safety
- Steering, Controls
- Pumps
- Fuel System
- Seating & Pedestals
- Trailering
- Tops & Covers
- Perform.
- Propellers
- Engine & Care
- Cleaning & Care
- Paint & Paint Acc.
- Fun & Flotation
- Topside Acc.
- Cockpit & Deck
- Hardware, Fasteners
- Camouflage
- Misc.
- Comm.

## Side Lights - Horizontal Mount

## Perko Fig. 1601 Side Lights - Horizontal Mount



- Black polymer.
- Great for Pontoon Boats.
- Normal "Base-Down".
- 1 mile visibility.
- Use on sail or power driven vessels under 12 meters in length.
- Height 1-7/8". Base dimensions: 1-1/8" x 3".
- Uses #8 fasteners.
- #71 12 volt bulbs included. 10 watts (each light).
- Sold per pair.

Order No.	Mfg. No. / Description	List Price	
<b>542488</b>	(1601 DPO BLK)	<b>\$84.69</b>	F0-8295000
<b>541739</b>	(0071 DPO CLR) Spare Bulbs - 2 Per Pack	<b>\$14.89</b>	F0-2401000

## Perko Fig. 253 Side Lights - Horizontal Mount



- Gold plated contacts.
- 2 mile visibility.
- Use on power driven vessels under 20 meters in length.
- Length 3-1/2", width 2-1/4", height 1-5/8".
- Uses #8 fasteners.
- #71 12 volt bulbs included. 10 watts (each light).
- Sold per pair.

Order No.	Mfg. No. / Description	List Price	
<b>542476</b>	(0253 W00 DP1) All White Polymer	<b>\$82.19</b>	F0-3575000
<b>5315117</b>	(0253 M00 DP1) Chrome Plated Bronze Top	<b>\$163.09</b>	F0-6141100
<b>541739</b>	(0071 DPO CLR) Spare Bulbs - 2 Per Pack	<b>\$14.89</b>	F0-2401000

## Attwood 66000 Series Side Lights - Deck Mount



- Corrosion resistant 304 stainless steel.
- 1 mile, 112.5° visibility.
- For use on boats up to 39.4' (12 meters).
- Dimensions: 2-1/2" L x 2-1/4" W x 1-1/2" H.
- Installs with three #6 fasteners (Not included).
- Includes: 7.5 watt lamp and 7" hard wire leads.
- 12 volt.

Order No.	Mfg. No. / Description	List Price	
<b>235437</b>	(6631967) Green	<b>\$43.29</b>	F0-0303000
<b>235449</b>	(66319R7) Red	<b>\$43.29</b>	F0-0303000
<b>7-3936</b>	Spare Bulbs, 2 Per Pack	<b>\$5.49</b>	F0-4830000

## Attwood Pulsar 5040 Series Side Lights - Deck Mount



- Black.
- 1 mile, 112.5° visibility.
- For use on boats up to 39.4' (12 meters).
- Cover and lens conceal installation fasteners and seal water out of lamp and hull.
- Diameter 2-3/8", height 1-7/16".
- Installs with two #10 fasteners (Not included).
- Includes: 9 watt wedge base lamp (#906).
- 12 volt.

Order No.	Mfg. No. / Description	List Price	
<b>233914</b>	(5040R7) Red	<b>\$27.99</b>	F0-9591000
<b>233926</b>	(5040G7) Green	<b>\$27.99</b>	F0-9591000

## Side Lights - Vertical Mount

## Marpac L.E.D. Side Lights - Vertical Mount



- Stainless steel housing.
- Certified USCG 2nm, for use on boats under 39.4' (12 meters).
- Dimensions: 3-5/8" L x 2-1/4" W.
- Uses (2) #8 flat/oval head screws per light (Not included).
- Meets the stringent requirements for USCG, ABYC A-16 and IMO COLREG.
- No bulbs to replace - LED's are Surface Mounted Diodes (SMB). 12 volt.
- Sold per pair - Red/Green.

Order No.	Description	List Price	
<b>7-6559</b>	LED Side Light - Vertical Mount	<b>\$55.19</b>	F0-3683000

## Marpac L.E.D. Side Lights - Vertical Mount



- For use on boats under 39.4' (12 meters).
- Dimensions: 3-1/2" L x 2-1/2" W.
- Uses #8 fasteners.
- No bulbs to replace - LED's are Surface Mounted Diodes (SMB). 12 volt.
- Sold per pair - Red/Green.

Order No.	Description	List Price	
<b>7-51213</b>	Black	<b>\$46.89</b>	F0-2823000
<b>7-51215</b>	White	<b>\$47.59</b>	F0-1333000

## Perko Fig. 274 L.E.D. Side Lights - Vertical Mount



- Chrome plated bronze.
- 2 mile visibility.
- Use on power driven vessels under 20 meters in length.
- Length 3-1/2", width 2-1/4", projection 1-3/8".
- Uses #8 fasteners.
- 12 volt. 4.8 watts (each light).
- Sold per pair.

Order No.	Mfg. No. / Description	List Price	
<b>536702</b>	(0274 M00 DP1)	<b>\$229.59</b>	F0-1706100

## Perko Fig. 617 L.E.D. Side Lights - Vertical Mount



- Polished stainless steel.
- Ultra low profile, low heat, long life.
- 1 mile visibility.
- Use on power driven vessels under 12 meters in length.
- Length 2-1/2", width 2-5/8", projection 5/8".
- Uses #8 fasteners.
- 12 volt. 2.6 watts (each light).
- Sold per pair.

Order No.	Mfg. No. / Description	List Price	
<b>544557</b>	(0617 DP2 STS)	<b>\$217.09</b>	F0-6915100

Side Lights - Vertical Mount

Perko Fig. 602 L.E.D. Side Lights - Vertical Mount



- Epoxy coated polymer.
- 2 mile visibility.
- Use on power driven vessels under 20 meters in length.
- Length 3-1/4", width 2", projection 1-1/4".
- Uses #8 fasteners.
- 12 volt. 1.2 watts (each light).
- Sold per pair.

Order No.	Mfg. No. / Description	List Price
541107	(0602 DP1 BLK) Black	\$217.59 F0-1325100
544432	(0602 DP1 WHT) White	\$247.69 G0-5956100

Perko Fig. 618 L.E.D. Side Lights - Vertical Mount



- Stainless steel with black polymer base.
- 2 mile visibility.
- Use on power driven vessels under 20 meters in length.
- Uses #6 fasteners.
- 12 volt.
- Sold per pair.

Order No.	Mfg. No. / Description	List Price
544494	(0618)	\$181.69 F0-8172100

Attwood LightArmor™ L.E.D. Side Lights - Vertical Mount



- Stainless steel.
- 2 mile visibility.
- For use on boats up to 65.6' (20 meters) in length.
- Height 1.02".

Order No.	Mfg. No. / Description	List Price
1147223	(NV3012SSG-7) Green Light	\$56.59 F0-1693000
1147224	(NV3012SSR-7) Red Light	\$56.59 F0-1693000

T-H Marine L.E.D. Bow Lights - Vertical Angled Gunnel Mount



- 316 stainless housing.
- 1 Nautical Mile USCG certification.
- Dimensions: 2-1/4" L x 1" W x 11/16" H.
- 12 volt.
- Sold per pair.

Order No.	Mfg. No. / Description	List Price
642733	(LED-LPNAV-ZDP)	\$89.09 F0-6326000

Marpac Side Lights - Vertical Mount



- Polished stainless steel housing.
- For use on boats up to 39.4' (12 meters).
- 1 mile visibility, 112.5°.
- Dimensions: 4" L x 2-1/4" W.
- Uses (3) #4 fasteners per light (included).
- #90 12 volt bulb (included).
- Sold per pair - Red/Green lens.

Order No.	Description	List Price
7-0111	Side Lights - Vertical Mount	\$34.59 F0-1242000
7-3936	Spare Bulbs, 2 Per Pack	\$5.49 F0-4830000

Marpac Side Lights - Vertical Mount



- Polished stainless steel housing.
- For use on boats up to 39.4' (12 meters).
- 1 mile visibility, 112.5°.
- Diameter 2-5/16".
- Uses (3) #4 fasteners per light (included).
- #90 12 volt bulb (included).
- Sold per pair - Red/Green lens.

Order No.	Description	List Price
7-0079	Side Lights - Vertical Mount	\$27.39 F0-7191000
7-3936	Spare Bulbs, 2 Per Pack	\$5.49 F0-4830000

Perko Fig. 170 European Style Navigation Light Sets - Vertical Mount



- All black polymer with colored lens.
- 2 mile visibility.
- Use on sail or power driven vessels under 20 meters in length.
- Overall height 3-5/8", width 4-1/8", projection 2-1/4".
- Uses #10 fasteners.
- Masthead: 10 watts. All others: 15 watts.
- 12 volt bulb included.

Order No.	Mfg. No. / Description	Visibility (Arc)	List Price
529050	(0170 BBO DP1) Bi-Color	2 Mile (225°)	\$55.29 F0-0783000
533270	(0170 BSD DP1) Green Side	2 Mile (112-1/2°)	\$44.99 F0-9413000
533271	(0170 BPO DP1) Red Side	2 Mile (112-1/2°)	\$44.99 F0-9413000
533269	(0170 BMO DP1) White Masthead	3 Mile (225°)	\$44.99 F0-9413000
533272	(0170 BSN DP1) White Stern	2 Mile (135°)	\$44.99 F0-9413000

SPARE 12 VOLT BULBS (2 PER PACK) FOR 533272

Order No.	Mfg. No. / Description	List Price
541530	(0069 DPO CLR) For 533272	\$18.79 F0-5131000
541638	(0070DP1CLR) For 533270, 533271, 533269	\$15.99 F0-9111000

- Electronics
- Trolling Motors
- Instruments
- Lighting
- Anchor & Dock
- Safety
- Steering, Controls
- Pumps
- Fuel System
- Seating & Pedestals
- Trailering
- Tops & Covers
- Perform.
- Propellers
- Engine & Care
- Cleaning & Care
- Paint & Paint Acc.
- Fun & Flotation
- Topside Acc.
- Cockpit & Deck
- Hardware, Fasteners
- Camouflage
- Misc.
- Comm.

Side Lights - Vertical Mount

Perko Fig. 955 Side Lights - Vertical Mount



- Polished stainless steel top with black polymer base.
- Gold plated contacts.
- 1 mile visibility.
- Use on sail or power driven vessels under 12 meters in length.
- Length 4-1/4", width 2-3/8", projection 1-9/16".
- Uses #4 fasteners.
- #71 12 volt bulbs included. 10 watts (each light).
- Sold per pair.



536361

Order No.	Mfg. No. / Description	List Price	
543948	(0955 DPO STS)	\$135.39	F0-7749000
536361	(0260 DPO LNS) Lens Set	\$19.39	F0-7531000
541739	(0071 DPO CLR) Spare Bulbs - 2 Per Pack	\$14.89	F0-2401000

Perko Fig. 1264 Side Lights - Vertical Mount



- Chrome plated zinc alloy top with vinyl gasket.
- Gold plated contacts.
- 1 mile visibility.
- Certified for replacement use only.
- Use on power driven vessels under 12 meters in length.
- Length 5-1/2", width 3-1/8", projection 1-3/4".
- Uses #8 fasteners.
- #71 12 volt bulbs included. 10 watts (each light).
- Sold per pair.

Order No.	Mfg. No. / Description	List Price	
533895	(1264 DPO CHR)	\$111.79	F0-5287000
533883	(1264 DPO LNS) Lens Set	\$28.69	F0-8002000
541739	(0071 DPO CLR) Spare Bulbs - 2 Per Pack	\$14.89	F0-2401000

Perko Fig. 254 Side Lights - Vertical Mount



- All black polymer.
- Gold plated contacts.
- 2 mile visibility.
- Use on power driven vessels under 20 meters in length.
- Length 3-1/2", width 2-1/4", projection 1-3/8".
- Uses #8 fasteners.
- #71 12 volt bulbs included. 8 watts (each light).
- Sold per pair.

Order No.	Mfg. No. / Description	List Price	
536067	(0254 B00 DP1)	\$83.09	F0-6185000
541739	(0071 DPO CLR) Spare Bulbs - 2 Per Pack	\$14.89	F0-2401000

Side Lights - Flush Mount

Marpac L.E.D. Side Lights - Flush Mount

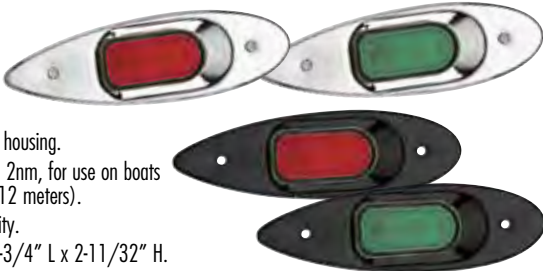

- Stainless steel housing.
- Certified USCG 2nm, for use on boats under 39.4' (12 meters).
- 112.5° visibility.
- Dimensions: 7-3/4" L x 2-11/32" H.
- Uses two #8 flat/oval head screws per light (Included).
- Meets the stringent requirements for USCG, ABYC A-16 and IMO COLREG.
- No bulbs to replace - LED's are Surface Mounted Diodes (SMB). 12 volt.
- Sold per pair - Red/Green.

Order No.	Description	List Price	
7-6595	Stainless Steel Housing	\$86.19	F0-3306000
7-6596	Stainless Steel Housing with Matte Black Finish	\$93.19	F0-3256000

Marpac Side Lights - Flush Mount



- Polished stainless steel housing.
- For use on boats up to 39.4' (12 meters).
- 1 mile visibility, 112.5°.
- Dimensions: 7-3/4" L x 2-1/4" W.
- #90 12 volt bulb (included).
- Sold per pair - Red/Green lens.

Order No.	Description	List Price	
7-0095	Side Lights - Flush Mount	\$39.49	F0-4672000
7-9034	Replacement Socket Assembly	\$6.09	F0-6240000
7-9336	Spare Bulbs, 2 Per Pack	\$5.49	F0-4830000

TACO Marine Rub Rail Mounted L.E.D. Navigation Light Set

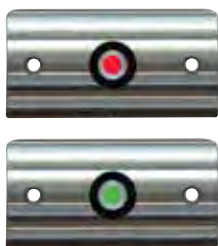

- Mounted in a heavy gauge polished stainless steel joiner cover.
- Ideal for 18' to 30' boats.
- Provides a 112.5° unobstructed view with less glare.
- Water-resistant, IP68 rating.
- Low-voltage 12-14 VDC.
- Dimensions: 3-3/8" W x 1-3/4" H x 5/8" D.
- Sold in pairs with one 3 watt port (Red) light and one 2 watt starboard (Green) light.
- Meets ABYC-USCG requirements for both sail and power boat designation.

Order No.	Mfg. No. / Description	List Price	
444251	(F38-6802-1)	\$227.69	F0-8395100

TACO Marine Rub Rail Mounted L.E.D. Navigation Light Set



- Mounted in a heavy gauge polished stainless steel joiner cover.
- Ideal for up to 30' boats and designed to fit the popular 3/4" insert profiles.
- Provides a 112.5° unobstructed view with less glare.
- Water-resistant, IP68 rating.
- Low-voltage 12-14VDC.
- Dimensions: 2-1/2" W x 3/4" H x 5/16" D.
- Sold in pairs with one 3 watt port (Red) light and one 2 watt starboard (Green) light.
- Certified for ABYC/USCG required for 2 NM for both sail and powerboat designation.

Order No.	Mfg. No. / Description	List Price	
444249	(F38-6800D)	\$239.79	F0-5876100

**Marpac L.E.D. Flexible Navigation Light Kit**

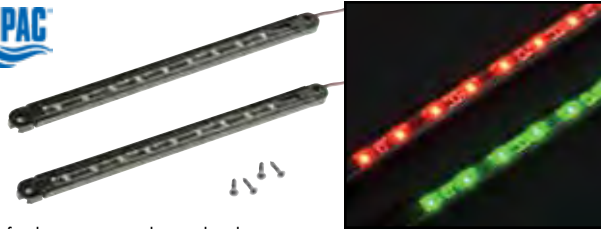

- Perfect for the no nonsense boater that does not have time to play around with obsolete navigational lights.
- Fully sealed LED navigation lights feature an ultra low profile and flexible design which allows for installation in almost any situation.
- (1) 6" red LED strip and (1) 6" green LED strip.
- Includes: Black PCB 2-black track with adhesive on back, (4) black end caps and (4) stainless steel screws.

Order No.	Description	List Price	
<b>7-52000</b>	LED Flexible Navigation Light Kit	<b>\$17.69</b>	F0-8321000

**Perko Fig. 1201 Tri-Color Light**



- Black polymer and chrome plated zinc alloy top with black polymer base.
- Fixed mount.
- Gold plated contacts.
- 2 mile visibility.
- Use on vessels under sail alone under 12 meters in length.
- Height overall: 4-1/8". Base dimensions: 1" x 2-5/8".
- Uses #8 fasteners.
- Two #71 12 volt bulbs included. 10 watts (each compartment).

Order No.	Mfg. No. / Description	List Price	
<b>533280</b>	(1201 DPO BLK)	<b>\$77.09</b>	F0-6935000
<b>541739</b>	(0071 DPO CLR) Spare Bulbs - 2 Per Pack	<b>\$14.89</b>	F0-2401000

**Pop-Up Bow Lights**

**Accon Pop-Up® Bow Light**

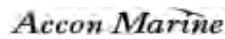

- Made of marine grade 316 stainless steel.
- Folds down flush when not in use.
- USCG Approved 1 nautical mile.
- Each light is supplied with a cut-out template.
- Fastens with three #10 screws (not included).

Order No.	Mfg. No. / Description	
<b>Special Order</b>	(204-M) Bow Light	<b>Call for Price</b>
<b>Special Order</b>	(204-M-C) Waterproofing Cup	<b>Call for Price</b>
<b>Special Order</b>	(204-RGL) Replacement Lens	<b>Call for Price</b>
<b>Special Order</b>	(204-B) Replacement Bulb	<b>Call for Price</b>
<b>Special Order</b>	(204-SOCKET) Replacement Socket	<b>Call for Price</b>
<b>Special Order</b>	(204-RK) Repair Kit	<b>Call for Price</b>

**Accon Pop-Up® L.E.D. Bow Lights**



- Made of marine grade 316 stainless steel.
- Folds down flush when not in use.
- USCG Approved 2 nautical mile.
- Fastens with three #10 screws (not included).

**210-M SERIES**

Order No.	Mfg. No. / Description	
<b>Special Order</b>	(210-M) Bow Light	<b>Call for Price</b>
<b>Special Order</b>	(210-M-S) Bow Light, Stud Mount	<b>Call for Price</b>
<b>Special Order</b>	(210-M-C) Waterproofing Cup for 210-M	<b>Call for Price</b>

**211-M SERIES**

Order No.	Mfg. No. / Description	
<b>Special Order</b>	(211-M) Bow Light, 204 Style	<b>Call for Price</b>
<b>Special Order</b>	(211-M-C) Waterproofing Cup for 211-M	<b>Call for Price</b>

**Pop-Up Side Lights**

**Accon Pop-Up® Lights**

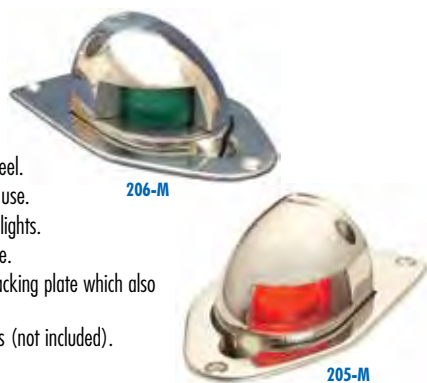

- Marine grade 316 stainless steel.
- Folds down flush when not in use.
- Keeps deck free of protruding lights.
- USCG Approved 1 nautical mile.
- Each light is shipped with a backing plate which also serves as a cut-out template.
- Fastens with three #10 screws (not included).
- 12 volt.

Order No.	Mfg. No. / Description	
<b>Special Order</b>	(205-M) Port Light	<b>Call for Price</b>
<b>Special Order</b>	(206-M) Starboard Light	<b>Call for Price</b>
<b>Special Order</b>	(204-M-C) Waterproofing Cup	<b>Call for Price</b>
<b>Special Order</b>	(204-B) Replacement Bulb	<b>Call for Price</b>
<b>Special Order</b>	(204-SOCKET) Replacement Socket	<b>Call for Price</b>
<b>Special Order</b>	(204-RK) Repair Kit	<b>Call for Price</b>

**Accon Pop-Up® Lights**



- Marine grade 316 stainless steel.
- Folds down flush when not in use.
- Keeps deck free of protruding lights.
- USCG Approved 1 nautical mile.
- Each light is shipped with a backing plate which also serves as a cut-out template.
- Fastens with three #10 screws (not included).
- 12 volt.

Order No.	Mfg. No. / Description	
<b>Special Order</b>	(207-M) Pair of Side Lights	<b>Call for Price</b>
<b>Special Order</b>	(204-M-C) Waterproofing Cup	<b>Call for Price</b>
<b>Special Order</b>	(204-B) Replacement Bulb	<b>Call for Price</b>
<b>Special Order</b>	(204-SOCKET) Replacement Socket	<b>Call for Price</b>
<b>Special Order</b>	(204-RK) Repair Kit	<b>Call for Price</b>

- Electronics
- Trolling Motors
- Instruments
- Electrical
- Lighting
- Anchor & Dock
- Safety
- Steering, Controls
- Pumps
- Fuel System
- Seating & Pedestals
- Trailering
- Tops & Covers
- Perform.
- Propellers
- Engine & Care
- Cleaning & Care
- Paint & Paint Acc.
- Fun & Flotation
- Topside Acc.
- Cockpit & Deck
- Hardware, Fasteners
- Camouflage
- Misc.
- Comm.



Removable Bi-Color Pole Lights

Perko Fig. 1617 L.E.D. Stealth Series Removable Bi-Color Pole Light



- Stainless steel and polymer top.
- Stow-a-way plug-in type pole.
- Polished with black top and locking collar.
- Pole length: 12". Pole rake: 0°.
- 3/4" diameter anodized aluminum tube.
- Gold plated contacts.
- 2 mile visibility.
- Use on power driven vessels under 20 meters in length.
- Requires 2-pin mounting base.
- Fits bases: 536384 (1045 P00 DP) and 536411 (1047 P00 DP).
- 12 volt. 2.6 watts.
- Must order base separately.

Order No.	Mfg. No. / Description	List Price	
544571	(1617 DP2 BLK)	\$197.39	F0-7183100
536384	(1045P0SDP) Base Dimensions: 2-1/4" OD	\$42.09	F0-6492000

Marpac L.E.D. Bi-Color Combination Bow Light



- Polished stainless steel housing.
- Low profile housing design.
- LED Advantage of low power use, long life and shock resistant durability.
- Certified USCG 2nm for night time navigation.
- 360° visibility.
- Pole length: 12".
- Anodized aluminum pole.
- Straight pole.
- Fits most 2-prong plug-in bases.
- Meets USCG A-16 Requirements.
- No bulbs to replace - LED's are Surface Mounted Diodes (SMB). 12 volt.

Order No.	Description	List Price	
7-51169	LED Bow Light	\$47.89	F0-2533000

Attwood LightArmor™ L.E.D. Bi-Color Stowaway Bow Light



- Red/green lens.
- Anodized aluminum pole.
- Locking collar.
- 2 mile, 225° visibility.
- For use on boats up to 39.4' (12 meters).
- Includes: 9 watt wedge base lamp.
- 2-Pin.

Order No.	Mfg. No. / Description	List Price	
234106	(NV6LC1-14-7) 14" Straight with Locking Collar Pole	\$54.79	F0-5383000
1147227	(NV6LC1-10A7) 10" Angled with Locking Collar Pole	\$55.19	F0-3683000
235160	(910R2PB-7) Plug-In Base with Black Composite Cover	\$16.89	F0-2811000
235172	(910R2PSB-7) Plug-In Base with Stainless Steel Cover	\$24.79	F0-5371000
235196	(910V2PB-7) Plug-In Base with Black Composite Cover	\$23.39	F0-7361000

Attwood LightArmor™ L.E.D. Bi-Color Stowaway Bow Light with Task Light



- Red/green lens.
- Anodized aluminum pole.
- Locking collar.
- 2 mile, 225° visibility.
- For use on boats up to 39.4' (12 meters).
- Includes: 9 watt wedge base lamp.
- The Task Light gives you a narrow beam work light that features a durable rubber "push-on" switch.
- 3-Pin.

Order No.	Mfg. No. / Description	List Price	
234118	(NV6LC2-14-7) 14" Straight with Locking Collar Pole	\$67.59	F0-1374000
235146	(910R3PB-7) Plug-In Base with Black Composite Cover	\$19.79	F0-5831000
235158	(910R3PSB-7) Plug-In Base with Stainless Steel Cover	\$26.19	F0-3381000

Marpac Bi-Color Stowaway Bow Light



- High impact construction.
- Red and green lens.
- Low profile nylon base with cap included.
- Removable, stores easily.
- 1 mile visibility, 225°.
- Pole length: 12".
- Stainless steel pole.
- 12 volt.

Order No.	Description	List Price	
7-51216	Bi-Color Bow Light	\$29.29	F0-0502000

Marpac Bi-Color Plug-In Bow Light



- Classic style zamak angled bow light.
- Red and green lens.
- Stores easily and replaces most common bow lights.
- 1 mile visibility, 225°.
- Anodized aluminum angled pole.
- Fits most 2-prong plug-in bases.
- Pole length: 10".
- 12 volt.

Order No.	Description	List Price	
7-51217	Bi-Color Bow Light	\$28.49	F0-4991000

LIMITED QUANTITIES

Marpac Tear Drop Bi-Color Bow Lights



- Plastic housing with aluminum pole.
- Quality die-cast zamak finish.
- Red and green lens.
- 1 mile visibility, 225°.
- Pole length: 10".
- Anodized aluminum pole.
- Fits most 2-prong plug-in bases.
- 12 volt.

Order No.	Description	List Price	
7-51220	Angled Pole	\$25.99	F0-9181000
7-51221	Straight Pole	\$22.39	F0-7651000

Electronics

Trolling Motors

Instruments

Electrical

Lighting

Anchor & Dock

Safety

Steering, Controls

Pumps

Fuel System

Seating & Pedestals

Trailering

Tops & Covers

Perform.

Propellers

Engine & Care

Cleaning & Care

Paint & Paint Acc.

Fun & Flotation

Topside Acc.

Cockpit & Deck

Hardware, Fasteners

Camouflage

Misc.

Comm.

Removable Bi-Color Pole Lights

Perko Fig. 1421/1422 Removable Bi-Color Pole Lights with Utility Lights



- Black polymer top and locking collar.
- Stow-a-way plug-in type pole.
- 3/4" diameter anodized aluminum tube.
- Gold plated contacts.
- Deck illuminating utility light.
- 2 mile visibility.
- Use on power driven vessels under 20 meters in length.
- Requires 3-pin mounting base.
- #71 12 volt bulb included. 10 watts.
- Must order base separately.

Order No.	Mfg. No. / Description	List Price	
5315081	(1421 DP2 CHR) Pole Rake: 0° Pole Length: 12"	\$57.59	FO-1304000
545395	(1421 DP3 CHR) Pole Rake: 0° Pole Length: 17-1/4"	\$56.59	FO-1693000
545410	(1422 DP2 CHR) Pole Rake: 5° Pole Length: 12"	\$57.59	FO-1304000
536396	(104530SDP) Base for 5315081 Pole Light	\$44.89	FO-2413000
536512	(1060 3BO DP) Base for 545410 Pole Light	\$46.39	FO-7423000
541739	(0071 DPO CLR) Spare Bulbs - 2 Per Pack	\$14.89	FO-2401000
5315138	(0064 000 CLR) Utility Light Bulb	\$8.39	FO-7850000

Perko Fig. 1211/1212 Removable Bi-Color Pole Lights with Utility Lights



- Zinc alloy and black polymer top and locking collar.
- Stow-a-way plug-in type pole.
- Pole length: 12-1/2".
- 3/4" diameter anodized aluminum tube.
- Gold plated contacts.
- Deck illuminating utility light.
- 1 mile visibility.
- Use on sail or power driven vessels under 12 meters in length.
- Requires 3-pin mounting base.
- #71 12 volt bulb included. 10 watts.
- Must order base separately.

Order No.	Mfg. No. / Description	List Price	
533315	(1211 DP2 CHR) Pole Rake: 0°	\$67.69	FO-8374000
536396	(104530SDP) Base for 533315 Pole Light	\$44.89	FO-2413000
536512	(1060 3BO DP) Base for Fig. 1212 Pole Light	\$46.39	FO-7423000
541739	(0071 DPO CLR) Spare Bulbs - 2 Per Pack	\$14.89	FO-2401000
5315138	(0064 000 CLR) Utility Light Bulb	\$8.39	FO-7850000

Perko Fig. 1612 Removable Bi-Color Pole Light

- Black polymer top and locking collar.
- Stow-a-way plug-in type pole.
- Pole length: 12". Pole rake: 0°.
- 3/4" diameter anodized aluminum tube.
- Gold plated contacts.
- 1 mile visibility.
- Use on sail or power driven vessels under 12 meters in length.
- Requires 2-pin mounting base.
- #71 12 volt bulb included. 10 watts.
- Must order base separately.

Order No.	Mfg. No. / Description	List Price	
535133	(1612 DP2 BLK)	\$47.09	FO-6923000
536384	(1045POSDP) Base Dimensions: 2-1/4" OD	\$42.09	FO-6492000
536764	(0283 DPA LNS) Lens	\$19.39	FO-7531000
541739	(0071 DPO CLR) Spare Bulbs - 2 Per Pack	\$14.89	FO-2401000



Attwood Pulsar™ Bi-Color Stowaway Bow Lights



- Red/green lens.
- Anodized aluminum pole.
- 1 mile, 225° visibility.
- For use on boats up to 39.4' (12 meters).
- Includes: 9 watt wedge base lamp.
- 2-Pin.
- 12 volt.

Order No.	Mfg. No. / Description	List Price	
234156	(5092-10-7) 10" Straight with Locking Collar Pole	\$37.39	FO-7162000
234157	(5092-14-7) 14" Straight with Locking Collar Pole	\$42.79	FO-5992000
234168	(5091-10-7) 10" Angled with Standard Pole	\$34.19	FO-3932000
234170	(5091-14-7) 14" Angled with Standard Pole	\$44.39	FO-7013000
235196	(910V2PB-7) Plug-In Base with Black Composite Cover	\$23.39	FO-7361000
235259	(911339-7) Plug-In Zamak Base for 234168	\$24.89	FO-2471000

**NEW MODEL**

Attwood Pulsar™ Bi-Color Stowaway Bow Light with Task Light



- Red/green lens.
- Snodized aluminum pole.
- 1 mile, 225° visibility.
- For use on boats up to 39.4' (12 meters).
- Includes: 9 watt wedge base lamp.
- The Task Light gives you a narrow beam work light that features a durable rubber "push-on" switch.
- 3-Pin
- 12 volt.

Order No.	Mfg. No. / Description	List Price	
2350202	(5095-10-7) 10" Straight with Locking Collar Pole	\$63.19	FO-3244000
235146	(910R3PB-7) Plug-In Base with Black Composite Cover	\$19.79	FO-5831000
235158	(910R3PSB-7) Plug-In Base with Stainless Steel Cover	\$26.19	FO-3381000

- Electronics
- Trolling Motors
- Instruments
- Electrical
- Lighting
- Anchor & Dock
- Safety
- Steering, Controls
- Pumps
- Fuel System
- Seating & Pedestals
- Trailering
- Tops & Covers
- Perform.
- Propellers
- Engine & Care
- Cleaning & Care
- Paint & Paint Acc.
- Fun & Flotation
- Topside Acc.
- Cockpit & Deck
- Hardware, Fasteners
- Camouflage
- Misc.
- Comm.

**Marpac L.E.D. Portable Clamp-On Bow Light**



- Easy to store.
- Compact size takes up less space on deck.
- Certified USCG 2nm, for use on boats under 23' (7 meters) with a maximum speed of 7 knots (8 MPH).
- Clamps vertically or horizontally for maximum flexibility.
- Includes: Clamp-on mount and fasteners.
- Requires (3) "AAA" Batteries (Not included).

Order No.	Description	List Price	
7-1312	LED Clamp-On Portable Bow Light	\$32.39	FO-7622000

**Marpac L.E.D. Portable Suction Cup All-Round Light**



- Easy to store.
- Compact size takes up less space on deck.
- Certified USCG 2nm, for use on boats under 23' (7 meters) with a maximum speed of 7 knots (8 MPH).
- Suction cup mount.
- One piece molded suction cup sticks and stays put.
- Requires (3) "AAA" Batteries (Not included).

Order No.	Description	List Price	
7-1316	LED Portable All-Round Light	\$29.79	FO-5802000

**Marpac L.E.D. Portable Suction Cup Bow Light**



- Easy to store.
- Compact size takes up less space on deck.
- Certified USCG 2nm, for use on boats under 23' (7 meters) with a maximum speed of 7 knots (8 MPH).
- Suction cup mount.
- One piece molded suction cup sticks and stays put.
- Requires (3) "AAA" Batteries (Not included).

Order No.	Description	List Price	
7-1313	LED Portable Bow Light	\$33.29	FO-0332000

**Masthead Lights**

**Marpac Masthead All-Round Light**



- Polished stainless steel housing.
- 360° visibility.
- Diameter 2-3/8".
- Uses (3) #4 fasteners (Included).
- #90 12 volt bulb (Included).

Order No.	Description	List Price	
7-0101	Masthead All-Round Light	\$13.99	G0-7390000
7-3936	Spare Bulbs, 2 Per Pack	\$5.49	FO-4830000

**LIMITED QUANTITIES**

**Marpac L.E.D. Portable Clamp-On All-Round Light**



- Easy to store.
- Compact size takes up less space on deck.
- Certified USCG 2nm, for use on boats under 23' (7 meters) with a maximum speed of 7 knots (8 MPH).
- Clamps vertically or horizontally for maximum flexibility.
- Includes: Clamp-on mount and fasteners.
- Requires (3) "AAA" Batteries (Not included).

Order No.	Description	List Price	
7-1315	LED Clamp-On Portable All-Round Light	\$29.79	FO-5802000

**Attwood L.E.D. Portable Navigation Light Kits**



- Water-resistant bow and stern navigation lights.
- Sealed electronics, built to last in harsh conditions.
- Sealed, shock-proof composite housing.
- Shatter-proof polycarbonate lens.
- Requires (3) "AAA" Batteries (Not included).

**NEW MODELS**

**CLAMP-ON - C-CLAMP MOUNTING STYLE**

Order No.	Mfg. No. / Description	Pole Style	List Price	
2350035	(14190-7) Marine Gray	Threaded	\$39.39	FO-7572000
233419	(14191-7) Real Tree Max-5 Camouflage	Threaded	\$48.59	FO-1043000
233407	(14194-7) Marine Gray	Telescoping	\$44.39	FO-7013000

**DECK MOUNT - SCREW-DOWN OR ADHESIVE PAD MOUNTING STYLE**

Order No.	Mfg. No. / Description	Pole Style	List Price	
233433	(14192-7) Marine Gray	Telescoping	\$57.79	FO-5404000

**Perko Fig. 964 Masthead Light - Horizontal Mount**



- Black polymer base.
- 2 mile visibility.
- Certified for replacement use only.
- Use on sail or power driven vessels under 12 meters in length.
- Base OD 2-3/8", height 1-5/8".
- Uses #4 fasteners.
- #71 12 volt bulb included. 10 watts.

Order No.	Mfg. No. / Description	List Price	
544015	(0964 DPO STS) Polished Stainless Steel Top	\$62.39	FO-7634000
541739	(0071 DPO CLR) Spare Bulbs - 2 Per Pack	\$14.89	FO-2401000

Stern and Transom Lights

Marpac L.E.D. Transom Light



- Marine grade stainless steel housing.
- Certified USCG 2nm, for use on boats under 65.5' (20 meters).
- Diameter 3".
- Uses two #8 flat/oval head screws (Included).
- Meets the stringent requirements for USCG, ABYC A-16 and IMO COLREG.
- No bulbs to replace - LED's are Surface Mounted Diodes (SMB). 12 volt.

Order No.	Description	List Price	
7-6577	LED Transom Light	\$39.59	FO-1772000

Attwood L.E.D. Transom Light



- For pleasure craft up to 65.6' (20 meters).
- Creating 135° of light at 3-mile of visibility.
- Electropolished stainless cover.
- Surface mount design utilizes a snap feature to eliminate exposed fasteners.
- Diameter 3", height 1/2".
- Meets standards ABYC C-5 & A-16, USCG CFR 183.810.

**NEW PRODUCT**

Order No.	Mfg. No. / Description	List Price	
233356	(65567)	\$82.39	FO-7675000

Marpac Transom Light - Round



- Polished stainless steel housing.
- Clear lens.
- 2 mile visibility.
- Diameter 3-1/8", depth 1-3/4".
- Supplied with rubber mounting gasket.
- Uses (2) #8 flat/oval head screws (Included).
- 12 volt, 15 watt, .97 amp bulb (Included).

Order No.	Description	List Price	
7-0577	Transom Light	\$8.79	GO-9850000
7-4010	Spare Bulbs, 2 Per Pack	\$5.99	FO-9140000

Marpac Transom Light - Rectangular



- Polished stainless steel housing.
- Clear lens.
- 2 mile visibility.
- Dimensions: 5-1/16" x 3-1/16".
- Supplied with rubber mounting gasket.
- Uses (2) #8 flat/oval head screws (Not included).
- 12 volt, 15 watt, .97 amp, 6 candlepower bulb included.

Order No.	Description	List Price	
7-0861	Transom Light	\$11.19	GO-0570000
7-4010	Spare Bulbs, 2 Per Pack	\$5.99	FO-9140000

Attwood Transom Light



- 304 stainless steel with a plastic body and watertight lamp socket.
- Vertical, flush mount.
- For pleasure craft up to 164' (50 meters).
- Creating 135° of light at 2-mile of visibility.
- Diameter 3".
- Includes: (2) stainless steel #10 screws.
- 7.5 watts at 12 volt.

**LIMITED QUANTITIES**

Order No.	Mfg. No. / Description	List Price	
1146356	(6356D7)	\$31.39	FO-7912000

Marpac Stern Light - Horizontal Mount



- Polished stainless steel housing.
- 135° visibility.
- Diameter 2-3/8".
- Uses (3) #4 fasteners (included).
- #90 12 volt bulb (included).

**LIMITED QUANTITIES**

Order No.	Description	List Price	
7-0081	Stern Light	\$14.09	GO-4490000
7-3936	Spare Bulbs - 2 Per Pack	\$5.49	FO-4830000

Perko Fig. 945 Stern Light - Vertical Mount



- Black polymer base.
- Certified for replacement use only. 2 mile visibility.
- Use on sail or power driven vessels under 20 meters in length.
- Base OD 2-3/8", projection 1-3/8".
- Uses #4 fasteners.
- #71 12 volt bulb included. 10 watts.

Order No.	Mfg. No. / Description	List Price	
543768	(0945 DPO STS) Polished Stainless Steel Top	\$57.19	FO-3004000
543769	(0945 DPO CHR) Chrome Plated Brass Top	\$70.09	GO-6964000
541739	(0071 DPO CLR) Spare Bulbs - 2 Per Pack	\$14.89	FO-2401000

Perko Fig. 946 Stern Light - Flush Mount



- Polished stainless steel top with polymer base.
- 2 mile visibility.
- Use on sail or power driven vessels under 20 meters in length.
- OD 3", depth 1".
- Uses #8 fasteners.
- #70 12 volt bulb included. 10 watts.

Order No.	Mfg. No. / Description	List Price	
543772	(0946 DP1 STS)	\$76.69	FO-8635000
543783	(0946 DPO 99A) Lens with O-ring	\$11.79	FO-5280000
541626	(0070 DPO CLR) Spare Bulbs - 2 Per Pack	\$15.09	FO-6501000

Perko Fig. 965 Stern Light - Horizontal Mount



- Polished stainless steel top with black polymer base.
- Gold plated contacts.
- 2 mile visibility.
- Use on sail or power driven vessels under 20 meters in length.
- Base OD 2-3/8", height 1-5/8".
- Uses #4 fasteners.
- #71 12 volt bulb included. 10 watts.

Order No.	Mfg. No. / Description	List Price	
544039	(0965 DPO STS)	\$62.39	FO-7634000
541739	(0071 DPO CLR) Spare Bulbs - 2 Per Pack	\$14.89	FO-2401000

Perko Fig. 939 Stern Light - Flush Mount



- Polished stainless steel top with black base.
- 2 mile visibility.
- Use on sail or power driven vessels under 20 meters in length.
- Height 3-3/8", width 5-3/16", depth 1-1/2".
- Uses #8 fasteners.
- #70 12 volt bulb included. 10 watts.

Order No.	Mfg. No. / Description	List Price	
543695	(0939 DP1 STS)	\$141.49	FO-4099000
536776	(0284 DPO CLR) Lens with O-ring	\$11.79	FO-5280000
541626	(0070 DPO CLR) Spare Bulbs - 2 Per Pack	\$15.09	FO-6501000

- Electronics
- Trolling Motors
- Instruments
- Electrical
- Lighting
- Anchor & Dock
- Safety
- Steering, Controls
- Pumps
- Fuel System
- Seating & Pedestals
- Trailering
- Tops & Covers
- Perform.
- Propellers
- Engine & Care
- Cleaning & Care
- Paint & Paint Acc.
- Fun & Flotation
- Topside Acc.
- Cockpit & Deck
- Hardware, Fasteners
- Camouflage
- Misc.
- Comm.

- Electronics
- Trolling Motors
- Instruments
- Electrical
- Lighting
- Anchor & Dock
- Safety
- Steering, Controls
- Pumps
- Fuel System
- Seating & Pedestals
- Trailing
- Tops & Covers
- Perform.
- Propellers
- Engine & Care
- Cleaning & Care
- Paint & Paint Acc.
- Fun & Flotation
- Topside Acc.
- Cockpit & Deck
- Hardware, Fasteners
- Camouflage
- Misc.
- Comm.

All-Round Light - Plug-In

Marpac L.E.D. All-Round Light - Plug-In



- Anodized aluminum pole is non-corrosive and watertight.
- 2 mile visibility, 360°.
- 2-pin standard plug.
- USCG approved.
- No bulbs to replace - LED's are Surface Mounted Diodes (SMB). 12 volt.

Order No.	Description	List Price	
7-51596	(51596) Length 36"	\$42.39	FO-7692000

Marpac L.E.D. All-Round Light - Plug-In



- Universal.
- Tough marine grade aluminum pole.
- For use with most 2-pin plug-in bases (Not included).
- Certified USCG 2nm, for use on boats under 39.4' (12 meters).
- 360° visibility.
- Meets the stringent requirements for USCG, ABYC A-16 and IMO COLREG.
- No bulbs to replace - LED's are Surface Mounted Diodes (SMB). 12 volt.

Order No.	Description	List Price	
7-6554	Length 42"	\$46.59	FO-1623000

Perko Fig. 1444 L.E.D. White All-Round Lights - Plug-In

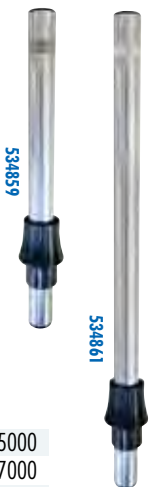

- Polymer top and base with clear frosted lens.
- New stylish high-tech design with self-contained LED module.
- LED optics adjust based on pole mount angles.
- 2 miles visibility.
- Use on power driven vessels under 20 meters in length.
- 3/4" diameter anodized aluminum tube.
- Fits bases: 1045, 1046, 1047, 1048, 1049 and 1060.
- Includes locking large threaded collars.
- Uses #8 fasteners.
- 12 volt. 1.28 watts.

Order No.	Mfg. No. / Description	List Price	
534859	(1444 DP2 ALU) Length 24"	\$85.39	FO-7795000
534861	(1444 DP5 ALU) Length 42"	\$102.69	FO-8817000
534873	(1444 DP7 ALU) Length 54"	\$116.59	FO-1618000

Perko Stealth Series L.E.D. White All-Round Lights - Plug-In



- Black polymer top and collar with clear fluted lens.
- Stow-a-way plug-in pole.
- Reduced glare design.
- Gold plated contacts.
- 2 mile visibility.
- Use on power driven vessels under 20 meters in length.
- 3/4" diameter anodized aluminum tube.
- Requires 2-pin mounting base.
- 12 volt. 1.5 watts.

FIG. 1442 STEALTH SERIES L.E.D. WHITE ALL-ROUND LIGHTS

- Pole rake: 0°. Locking collar.
- Fits bases: 536384 (1045 P00 DP) and 536411 (1047 P00 DP).

Order No.	Mfg. No. / Description	List Price	
544608	(1442 003 CHR) Length 30"	\$110.99	GO-6347000
544622	(1442 005 CHR) Length 42"	\$123.69	FO-8568000
544646	(1442 007 CHR) Length 54"	\$129.89	FO-2909000

FIG. 1347 STEALTH SERIES L.E.D. WHITE ALL-ROUND LIGHTS

- Pole rake: Adjustable. Locking and threaded collar.
- Fits bases: 536384 (1045 P00 DP), 1046 P00 DP, 536411 (1047 P00 DP), 536435 (1048 P00 DP), 536485 (1059 P00 DP) and 536500 (1060 PBO DP).

Order No.	Mfg. No. / Description	List Price	
544759	(1347 DP5 CHR) Length 42"	\$137.39	FO-7169000

Attwood LightArmor™ L.E.D. All-Around Articulating Lights - Plug-In



- Articulating head for use in all applications.
- Anti-glare.
- Anodized aluminum pole.
- For use on boats up to 39.4' (12 meters).
- 2 mile, 360° visibility.
- 2-pin locking collar pole.
- Operating range = 10.5V dc - 14.4V dc.

Order No.	Mfg. No. / Description	List Price	
235386	(5530-24A7) Length 24"	\$66.39	FO-7464000
1146981	(5530-36A7) Length 36"	\$69.59	FO-1784000
235398	(5530-42A7) Length 42"	\$82.49	FO-4775000
1145529	(5530-54A7) Length 54"	\$78.39	FO-7845000
235160	(910R2PB-7) Plug-In Base with Black Composite Cover	\$16.89	FO-2811000
235172	(910R2PSB-7) Plug-In Base with Stainless Steel Cover	\$24.79	FO-5371000
235196	(910V2PB-7) Plug-In Base with Black Composite Cover	\$23.39	FO-7361000

Attwood LightArmor™ L.E.D. Fast Action All-Around Lights - Plug-In



- Flexible, impact-resistant composite pole make these perfect for anglers and hunters to maneuver through low-hanging obstacles.
- Glare-free black matte finish.
- Impact-resistant polycarbonate lens.
- Water resistant, corrosion/UV resistant.
- Light head adjusts 15° fore to 15° aft.
- Threaded locking collar fits securely with LightArmor Plug-In Light Bases.
- Meets standards ABYC C-5 & A-16, USCG CFR 183.810.

Order No.	Mfg. No. / Description	List Price	
1147239	(5530-36BP7) Length 36"	\$70.09	FO-6094000
233205	(5530-42BP7) Length 42"	\$82.49	FO-4775000
1147241	(5530-54BP7) Length 54"	\$86.89	FO-2806000
235160	(910R2PB-7) Plug-In Base with Black Composite Cover	\$16.89	FO-2811000
235172	(910R2PSB-7) Plug-In Base with Stainless Steel Cover	\$24.79	FO-5371000
235196	(910V2PB-7) Plug-In Base with Black Composite Cover	\$23.39	FO-7361000

All-Round Light - Plug-In

Marpac All-Round Lights - Plug-In



- 3/4" anodized aluminum pole.
- For use on boats under 39.4' (12 meters).
- 360° visibility.
- Standardized pole fits Attwood and other competitive 2-pin bases.
- #1004 12 volt bulb (included).

Order No.	Description	List Price	
7-51251	Length 24"	\$27.29	FO-0191000
7-51253	Length 36"	\$30.69	FO-8412000
7-51255	Length 48"	\$35.79	FO-5052000
7-51258	Replacement Globe	\$3.99	FO-9720000
7-3966	Spare Bulbs, 2 Per Pack	\$5.49	FO-4830000

Perko Inland Series White All-Round Lights - Plug-In



- Black polymer top and collar with clear fluted lens.
- Stow-a-way plug-in pole.
- Pole rake: 5°.
- Locking collar.
- Reduced glare design.
- 3/4" diameter anodized aluminum tube.
- 2 mile visibility.
- Use on power driven vessels under 20 meters in length.
- Requires 2-pin mounting base.
- Fits base: 536500 (1060 PBO DP).
- 12 volt bulb included. 9 watts.

Order No.	Mfg. No. / Description	List Price	
534725	(1445 DP5 CHR) Length 42"	\$48.39	FO-7833000
534746	(1445 DP7 CHR) Length 54"	\$56.29	FO-0493000
535306	(0238 DPO BLK) Globe	\$13.99	FO-9790000
537475	(0338 DP2 CLR) Spare Bulbs - 2 Per Pack	\$11.19	FO-3870000

Perko Inland Series White All-Round Lights - Plug-In



- Black polymer top and collar with clear fluted lens.
- Stow-a-way plug-in pole.
- Pole rake: 0°.
- Locking collar.
- Reduced glare design.
- 3/4" diameter anodized aluminum tube.
- 2 mile visibility.
- Use on power driven vessels under 20 meters in length.
- Requires 2-pin mounting base.
- Fits bases: 536384 (1045 P00 DP) and 536411 (1047 P00 DP).
- 12 volt bulb included. 9 watts.

Order No.	Mfg. No. / Description	List Price	
534705	(1440 DP2 CHR) Length 24"	\$37.89	FO-2562000
534707	(1440 DP4 CHR) Length 36"	\$42.99	FO-9003000
534708	(1440 DP5 CHR) Length 42"	\$47.09	FO-6923000
534709	(1440 DP6 CHR) Length 48"	\$53.59	FO-1573000
534710	(1440 DP7 CHR) Length 54"	\$54.79	FO-5383000
535306	(0238 DPO BLK) Globe	\$13.99	FO-9790000
537475	(0338 DP2 CLR) Spare Bulbs - 2 Per Pack	\$11.19	FO-3870000

Perko Coastal Series White All-Round Lights - Plug-In



- Black polymer top and collar with clear fluted lens, frosted top.
- Stow-a-way plug-in pole.
- 3/4" diameter anodized aluminum tube.
- 2 mile visibility.
- Use on power driven vessels under 20 meters in length.
- Requires 2-pin mounting base.
- 12 volt bulb included. 9 watts.

FIG. 1460 WHITE ALL-ROUND NAVIGATION LIGHTS

- Pole rake: 0°. Locking collar.
- Fits bases: 536384 (1045 P00 DP) and 536411 (1047 P00 DP).

Order No.	Mfg. No. / Description	List Price	
534823	(1460 DP5 CHR) Length 42"	\$48.39	FO-7833000
534835	(1460 DP7 CHR) Length 54"	\$56.29	FO-0493000

FIG. 1465 WHITE ALL-ROUND NAVIGATION LIGHTS

- Pole rake: 5°. Locking collar.
- Fits base: 536500 (1060 PBO DP).

Order No.	Mfg. No. / Description	List Price	
M617-2007	(1465 DP6 CHR) Length 54"	\$49.25	Z0-4503000

LIMITED QUANTITIES

ACCESSORIES

Order No.	Mfg. No. / Description	List Price	
535318	(0239 DPO BLK) Black/Clear Globe	\$13.99	FO-9790000
537475	(0338 DP2 CLR) Spare Bulbs - 2 Per Pack	\$11.19	FO-3870000

Perko Delta Series White All-Round Lights - Plug-In



- Black polymer top and collar with clear fluted lens, frosted top.
- Stow-a-way plug-in pole.
- Pole rake: Adjustable.
- Locking and threaded collar.
- 2 globes - reduced glare & full output.
- Wide 40° head adjustability.
- 3/4" diameter anodized aluminum tube.
- 2 mile visibility.
- Use on power driven vessels under 20 meters in length.
- 2 screw positions for multiple base applications.
- Requires 2-pin mounting base.
- Fits bases: 536384 (1045 P00 DP), 1046 P00 DP, 536411 (1047 P00 DP), 536435 (1048 P00 DP), 536485 (1059 P00 DP) and 536500 (1060 PBO DP).
- 12 volt bulb included. 9 watts.

Order No.	Mfg. No. / Description	List Price	
534758	(1470 DP5 CHR) Length 42"	\$62.69	FO-8834000
534772	(1470 DP8 CHR) Length 60"	\$73.89	FO-2715000
535318	(0239 DPO BLK) Black/Clear Globe	\$13.99	FO-9790000
537475	(0338 DP2 CLR) Spare Bulbs - 2 Per Pack	\$11.19	FO-3870000

- Electronics
- Trolling Motors
- Instruments
- Electrical
- Lighting
- Anchor & Dock
- Safety
- Steering, Controls
- Pumps
- Fuel System
- Seating & Pedestals
- Trailering
- Tops & Covers
- Perform.
- Propellers
- Engine & Care
- Cleaning & Care
- Paint & Paint Acc.
- Fun & Flotation
- Topside Acc.
- Cockpit & Deck
- Hardware, Fasteners
- Camouflage
- Misc.
- Comm.

All-Round Light - Plug-In

Perko Fig. 1209 White All-Round Light - Plug-In



536031

- Chrome plated brass top and base with clear fresnel globe.
- Stow-a-way plug-in pole.
- Gold plated contacts.
- Waterproof cover for base that attaches to deck mounted retainer when light is in place.
- 3/4" diameter anodized aluminum tube.
- 2 mile visibility.
- Use on power driven vessels under 20 meters in length.
- Pole rake: 16°.
- Includes: 2-pin mounting base. Base dimensions: 3-3/8" x 2-1/4".
- Uses #8 fasteners.
- 12 volt bulb included. 7 watts.

Order No.	Mfg. No. / Description	List Price	
533302	(1209 DP3 CHR) Length 30"	\$131.69	FO-8129000
536031	(0248 DPO CLR) Spare Globe	\$17.39	FO-7121000
7-3936	Spare Bulbs, 2 Per Pack	\$5.49	FO-4830000

Perko Alpha Series White All-Round Lights - Plug-In



535611

- Black polymer top and collar with white translucent globe.
- Stow-a-way plug-in pole.
- Gold plated contacts.
- Provides limited cockpit illumination.
- Universal replacement lights are designed to fit most other manufacturers' bases. They feature two collars (one threaded and one locking), two screw positions, and a full output translucent globe (360°).
- Pole rake: Adjustable. Locking and threaded collar.
- 3/4" diameter anodized aluminum tube.
- 2 mile visibility.
- Use on sail or power driven vessels under 20 meters in length.
- Requires 2-pin mounting base.
- 12 volt bulb included. 11 watts.

Order No.	Mfg. No. / Description	List Price	
534633	(1400 DP5 CHR) Length 42"	\$52.69	GO-0353000
534657	(1400 DP7 CHR) Length 54"	\$62.59	FO-1834000
535611	(0201 DPO WHT) White Translucent Globe	\$15.99	FO-9111000

- Electronics
- Trolling Motors
- Instruments
- Electrical
- Lighting
- Anchor & Dock
- Safety
- Steering, Controls
- Pumps
- Fuel System
- Seating & Pedestals
- Trailering
- Tops & Covers
- Perform.
- Propellers
- Engine & Care
- Cleaning & Care
- Paint & Paint Acc.
- Fun & Flotation
- Topside Acc.
- Cockpit & Deck
- Hardware, Fasteners
- Camouflage
- Misc.
- Comm.

Attwood All-Round Articulating Lights - Plug-In



- They focus light at the horizon and above, not in the pilot's eyes.
- The bottom aperture reduces glare at 7.5° below horizontal.
- Above horizontal, the continuous arc of light makes the boat more visible to taller craft.
- The patented Articulating Head adjusts from 15° forward to 15° aft.
- Anti-glare.
- 2 mile, 360° visibility.
- 2-pin locking collar pole.

Order No.	Mfg. No. / Description	List Price	
235415	(5330-42-7) Length 42"	\$46.09	FO-6223000
235160	(910R2PB-7) Plug-In Base with Black Composite Cover	\$16.89	FO-2811000
235172	(910R2PSB-7) Plug-In Base with Stainless Steel Cover	\$24.79	FO-5371000
235196	(910V2PB-7) Plug-In Base with Black Composite Cover	\$23.39	FO-7361000
235806	(912852-7) Spare Globe	\$4.59	FO-1230000

Attwood All-Round Telescoping Light - Plug-In



- Stores easily in less space than a conventional all-around light and can be removed quickly from any Attwood pole light base.
- Aluminum pole telescopes from 30" to 48".
- 2 mile, 360° visibility.
- For use on boats up to 39.4' (12 meters).
- Includes: 12 watt lamp.

Order No.	Mfg. No. / Description	List Price	
1145610	(5610-48-7)	\$45.59	FO-1913000

LIMITED QUANTITIES

Attwood All-Round Lights - Plug-In



235196

235172

235160

2350155

- Frosted globe.
- 2 mile, 360° visibility.
- For use on boats up to 39.4' (12 meters).
- 2-pin locking collar pole.
- Includes: 9 watt wedge-base lamp.
- 12 volt.

2-PIN LOCKING COLLAR POLE

Order No.	Mfg. No. / Description	List Price	
235324	(5110-24-7) Length 24"	\$25.69	FO-8971000
235336	(5110-30-7) Length 30"	\$32.29	FO-0622000
1145107	(5110-36-7) Length 36"	\$37.19	FO-3062000
235348	(5110-42-7) Length 42"	\$37.19	FO-3062000
235350	(5110-48-7) Length 48"	\$39.89	FO-2972000

2-PIN STANDARD POLE

Order No.	Mfg. No. / Description	List Price	
1145099	(5100-24-1) Length 24"	\$23.59	FO-1561000
1145101	(5100-54-1) Length 54"	\$47.99	FO-9533000

BASES AND ACCESSORIES

Order No.	Mfg. No. / Description	List Price	
235160	(910R2PB-7) Plug-In Base with Black Composite Cover	\$16.89	FO-2811000
235172	(910R2PSB-7) Plug-In Base with Stainless Steel Cover	\$24.79	FO-5371000
235196	(910V2PB-7) Plug-In Base with Black Composite Cover	\$23.39	FO-7361000
2350155	(910836B) Replacement Socket	\$8.69	FO-8060000

SPECIAL HANDLING MAY APPLY



All-Round Light - Plug-In

Attwood All-Round Stowaway Lights - Plug-In



- Frosted globe.
- Swivel cover on base protects the socket when light is stowed. Base extends just 3" below deck.
- 3/4" diameter anodized aluminum pole.
- 2 mile, 360° visibility.
- 2-pin standard pole.
- For use on boats up to 39.4' (12 meters).
- Base dimensions: 4" L x 1-5/8" W x 1-3/8" D.
- Three countersunk holes for #10 fasteners.
- Includes: Angled zamak base (911339) and 9 watt wedge-base lamp.
- 12 volt.



2350155

Order No.	Mfg. No. / Description	List Price	
1147103	(7100A7) Length 24"	\$51.79	FO-5263000
235475	(7100B7) Length 30"	\$58.99	FO-9214000
1147140	(7100C7) Length 30"	\$60.79	FO-5524000
2350155	(910836B) Replacement Socket	\$8.69	FO-8060000

Attwood All-Round Folding Light - Plug-In



- Same features of the patented Articulating Anti-Glare light plus one great advantage - the removable pole folds in half for easy stowage.
- The mid-point hinge is corrosion resistant, glass-filled black plastic with a durable hinge pin.
- Anti-glare.
- 2 mile, 360° visibility.
- 2-pin locking collar pole.



235806

Order No.	Mfg. No. / Description	List Price	
235184	(5340-54-7) Length 54"	\$76.79	FO-5735000
235160	(910R2PB-7) Plug-In Base with Black Composite Cover	\$16.89	FO-2811000
235172	(910R2PSB-7) Plug-In Base with Stainless Steel Cover	\$24.79	FO-5371000
235196	(910V2PB-7) Plug-In Base with Black Composite Cover	\$23.39	FO-7361000
235806	(912852-7) Spare Globe	\$4.59	FO-1230000

Plug-In Light Bases

Marpac Chrome Plated Plug-In Light Base



- Chrome plated zamak.
- 2 pin socket fits most plug-in style poles.
- Built-in cover plate protects the socket and locks in the light pole.
- Keyed to help prevent wrongful insertion.
- Direct replacement for Attwood and other competitive brands.



Order No.	Description	List Price	
7-0370	Plug-In Light Base	\$17.09	FO-6911000

Marpac Chrome Plated Plug-In Light Base



- Chrome plated round light base.
- 2 pin socket fits most plug-in style poles.
- Includes a sure-fit collar.
- Rubber cover.
- Requires #8 mounting screws (Not included).



Order No.	Description	List Price	
7-51272	Plug-In Light Base	\$8.49	FO-4950000

Marpac Black Nylon Plug-In Light Base



- Corrosion resistant, black nylon construction.
- 2 pin socket fits most plug-in style poles.
- Sliding cover keeps water out when not in use.



Order No.	Description	List Price	
7-51275	Plug-In Light Base	\$4.19	FO-3920000

Marpac Black Nylon Plug-In Light Base



- Corrosion resistant, black nylon construction.
- 2 pin socket fits most plug-in style poles.
- Keeps clean and dry when not in use with rubber cover.
- Direct replacement for Attwood and other competitive brands.



Order No.	Description	List Price	
7-51274	Plug-In Light Base	\$10.69	FO-8470000

T-H Marine Snap Flex Plug-In Base



- Patented design quick-release base.
- 3/16" stainless base.
- UV stable cover keeps water out when not in use.
- Easily mounted with 3 screws (Not provided).



LIMITED QUANTITIES

Order No.	Mfg. No. / Description	List Price	
642695	(LED-NAVSFSB)	\$65.39	FO-7754000

Perko Fig. 1048 Plug-In Type Base



- Chrome plated brass and black polymer base.
- Rake: 5°. Threaded collar.
- Number of pins: 2.
- Base dimensions: 3-1/2" x 2".
- Uses #8 fasteners.
- Waterproof snap-on cover and pigtail leads.
- Fits Figs. 1343, 1347, 1348, 1349, 1451, 1400, 1403, 1445L, 1470, 1622, 1624 and 1656.



Order No.	Mfg. No. / Description	List Price	
536435	(1048 P00 DP)	\$43.29	FO-0303000

Perko Fig. 1059 Plug-In Type Base



- Chrome plated zinc alloy and black polymer base.
- Rake: 16°. Locking collar.
- Number of pins: 2.
- Base dimensions: 3-3/4" x 1-5/8".
- Uses #8 fasteners.
- Waterproof snap-on cover and pigtail leads.
- Fits Figs. 1330, 1343, 1347, 1348, 1349, 1400, 1404, 1451 and 1470.



Order No.	Mfg. No. / Description	List Price	
536485	(1059 P00 DP)	\$39.89	FO-2972000

- Electronics
- Trolling Motors
- Instruments
- Electrical
- Lighting
- Anchor & Dock
- Safety
- Steering, Controls
- Pumps
- Fuel System
- Seating & Pedestals
- Trailering
- Tops & Covers
- Perform.
- Propellers
- Engine & Care
- Cleaning & Care
- Paint & Paint Acc.
- Fun & Flotation
- Topside Acc.
- Cockpit & Deck
- Hardware, Fasteners
- Camouflage
- Misc.
- Comm.



Plug-In Light Bases

Plug-In Light Bases

Perko Fig. 1045 Plug-In Type Bases



- Chrome plated brass and black polymer base.
- Rake: 0°. Locking collar.
- Base dimensions: 2-1/4" OD.
- Uses #8 fasteners.
- Waterproof snap-on cover and pigtail leads.

NUMBER OF PINS: 2

- Fits Perko Figs. 1343, 1347, 1348, 1349, 1400, 1404, 1440, 1440L, 1442, 1450, 1451, 1452, 1460, 1454, 1470, 1612 and 1616.

Order No.	Mfg. No. / Description	List Price	
536384	(1045POSDP)	\$42.09	F0-6492000

NUMBER OF PINS: 3

- Fits Perko Figs. 1211 and 1421.

Order No.	Mfg. No. / Description	List Price	
536396	(104530SDP)	\$44.89	F0-2413000

Perko Fig. 1060 Plug-In Type Bases



- Chrome plated zinc alloy and black polymer base.
- Rake: 5°. Locking collar
- Base dimensions: 3-3/4" x 1-3/4"
- Uses #8 fasteners.
- Waterproof snap-on cover and pigtail leads.

NUMBER OF PINS: 2

- Fits Perko Figs. 1343, 1347, 1348, 1349, 1400, 1404, 1445, 1447, 1451, 1455, 1456, 1465 and 1470.

Order No.	Mfg. No. / Description	List Price	
536500	(1060 PBO DP)	\$41.79	F0-5292000

NUMBER OF PINS: 3

- Fits Perko Figs. 1212 and 1422.

Order No.	Mfg. No. / Description	List Price	
536512	(1060 3BO DP)	\$46.39	F0-7423000

Attwood Square 2-Pin Base for Straight Poles



- 2-pin light base, constructed of nylon.
- Hinged cover snaps closed to keep dirt and water out when light is stowed.
- Four countersunk holes for installation of fasteners.
- Dimensions: 2-1/4" x 1-3/4". 1-1/4" diameter installation hole size.

NEW PRODUCT

Order No.	Mfg. No. / Description	List Price	
235211	(911370-1)	\$14.09	F0-6890000

Attwood Oval 2-Pin Base for Angled Poles



- Black composite.
- 2-pin light base for angled pole lights with locking collars.
- Features a soft rubber cover with a gasket to seal the socket.
- Contacts are nickel-plated to resist corrosion.

Order No.	Mfg. No. / Description	List Price	
2350211	(91022-7)	\$16.19	F0-3311000

Attwood Rectangle 2-Pin Base for 12° Angled Poles



- Zamak.
- 2-pin light base.
- Swivel cover protects the socket when light is stowed away.
- Socket is keyed to prevent incorrect insertion of pole light.
- Dimensions: 4" x 1-5/8".
- Includes 7-1/2" hard wire leads for connection to 12 volt power supply.

Order No.	Mfg. No. / Description	List Price	
235259	(911339-7)	\$24.89	F0-2471000
1149140	(911339-1)	\$23.79	F0-2471000

Attwood Rectangle 2-Pin Base for 12° Angled Poles

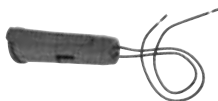

Order No.	Mfg. No. / Description	List Price	
2350155	(910836B)	\$8.69	F0-8060000

Attwood LightArmor™ 910V Series Rectangle Base



- Black composite cover.
- 2-pin light base.

Order No.	Mfg. No. / Description	List Price	
235196	(910V2PB-7)	\$23.39	F0-7361000

Attwood LightArmor™ Plug-In Round Bases



- The threaded design feature fits perfectly with the threaded locking collar now offered across the entire line of Attwood pole lights.
- Unique cover design ensures that the cover stays in place.
- Low-profile prevents water from pooling on the top surface.

NEW MODELS

ROUND DESIGN WITH 2-PIN BASE

Order No.	Mfg. No. / Description	List Price	
235160	(910R2PB-7) Black Composite Cover	\$16.89	F0-2811000
235172	(910R2PSB-7) Overmold 306 SS Black Cover	\$24.79	F0-5371000

TEARDROP DESIGN WITH 2-PIN BASE

Order No.	Mfg. No. / Description	List Price	
235261	(910T2PB-7) Black Composite Cover	\$20.19	F0-3141000
235273	(910T2PSB-7) Overmold 306 SS Black Cover	\$35.39	F0-7742000

ROUND DESIGN WITH 3-PIN BASE

Order No.	Mfg. No. / Description	List Price	
235146	(910R3PB-7) Black Composite Cover	\$19.79	F0-5831000
235158	(910R3PSB-7) Overmold 306 SS Black Cover	\$26.19	F0-3381000

## Attwood L.E.D. Waketower All-Round Light

- Compact size designed for installation on a wakeboard tower, radar arch, hard top, poling platform, tuna tower or other fixed structure.
- 2 mile, 360° visibility.
- For use on pleasurecraft up to 39.4' (12 meters).
- Tab release.
- 6" wire leads.

Order No. Mfg. No. / Description  
**235499** (5580A7)

List Price  
**\$65.29** F0-0754000



## All-Round Light - Folding

## Marpac L.E.D. All-Round Light - Folding



- Made from corrosion resistant materials.
- Excellent for use on pontoon boats, hard tops and radar arches.
- Certified USCG 2nm, for use on boats under 39.4' (12 meters).
- 360° visibility.
- Uses three #8 flat/oval head screws (Not included).
- Meets the stringent requirements for USCG, ABYC A-16 and IMO COLREG.
- No bulbs to replace - LED's are Surface Mounted Diodes (SMB). 12 volt.

Order No. Description  
**7-6551** Length 7"

List Price  
**\$42.19** F0-3592000



## Marpac L.E.D. All-Round Light - Folding



- Glare-proof LED.
- Water resistant lens capsule.
- 3/4" aluminum pole with UV stabilized plastic fittings.
- Certified USCG 2nm, for use on boats under 39.4' (12 meters).
- 360° visibility.
- No bulbs to replace - LED's are Surface Mounted Diodes (SMB). 12 volt.

Order No. Description  
**7-6543** Length 12"

List Price  
**\$23.09** G0-7451000



## Marpac L.E.D. All-Round Light - Folding



- 3/4" anodized aluminum pole.
- Certified USCG 2nm, for use on boats under 39.4' (12 meters).
- 360° visibility.
- Adjusts to any angle with thumbscrew.
- Base dimensions: 2-1/2" x 1-7/8".
- Uses three #10 flat/oval head screws (Not included).
- Meets USCG A-16 Requirements.
- No bulbs to replace - LED's are Surface Mounted Diodes (SMB). 12 volt.

Order No. Description  
**7-51598** Length 10-1/2"

List Price  
**\$37.19** F0-3062000



## Perko Stealth Series L.E.D. White All-Round Lights - Folding



- Black polymer top and base with clear fluted lens.
- 360° reduced glare design.
- Fold-down, adjustable angle.
- 2 miles visibility.
- Use on power driven vessels under 20 meters in length.
- 3/4" diameter anodized aluminum tube.
- Uses #8 fasteners.
- 12 volt. 1.5 watts.

## VERTICAL MOUNT

- Folds down 90° in either direction along the plane of attachment plate of the mount.
- Length 14-1/4". Base dimensions: 2-1/4" x 5/8".

Order No. Mfg. No. / Description  
**544709** (1639 DPO CHR)

List Price  
**\$119.39** F0-7538000



## HORIZONTAL MOUNT

- Folds down 90° in either direction opposite the plane of attachment plate of the mount.
- Length 14-1/4". Base dimensions: 2" x 1-1/2".

Order No. Mfg. No. / Description  
**544696** (1636 DPO CHR)

List Price  
**\$119.39** F0-7538000

## Attwood LightArmor™ L.E.D. All-Round Lights - Folding



- Articulating head for use in all applications.
- Anti-glare.
- Durable, anodized aluminum pole.
- Includes fold-down composite black base.
- 2 mile, 360° visibility.
- For use on boats up to 39.4' (12 meters).
- Shock, corrosion and water proof electronics.

Base



## HORIZONTAL MOUNT WITH ADAPTOR (3.50" x 1.52")

Order No. Mfg. No. / Description  
**235538** (5557-PV12A7) Length 12" **\$61.89** F0-2334000

## VERTICAL MOUNT WITH ADAPTOR (3.50" x 1.24")

Order No. Mfg. No. / Description  
**1146993** (5557-PV12A7) Length 12" **\$62.39** F0-7634000  
**235540** (5551-PA20-7) Length 20" **\$78.29** F0-0845000

## T-H Marine L.E.D. All-Round Light - Folding



- LED fold down, all around pontoon lights.
- 2 Nautical Miles USCG certification.
- Injection molded nylon with 3/16" stainless base.
- Length 24".
- Mounts on 1-1/4" square tubing and on 3/4" round tubing.

Order No. Mfg. No. / Description  
**642645** (LED-BTSL-24-DP)

List Price  
**\$90.89** F0-2636000



Marpac All-Round Lights - Folding



- Designed for t-tops, hardtops or any other higher mounting spots.
- Certified USCG 2nm, for use on boats under 39.4' (12 meters).
- 360° visibility.
- Length 12".
- Fold down base adjusts to any angle.

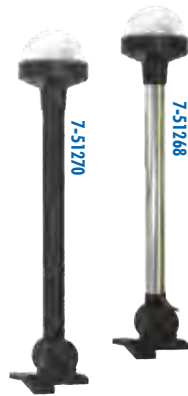

Order No.	Description	List Price	
7-51268	Chrome Pole	\$13.09	F0-6190000
7-51270	Black Pole	\$13.09	F0-6190000

Marpac All-Round Light - Folding



- Anodized aluminum pole.
- Anti-glare lens.
- 2 mile visibility, 360°.
- Includes fold down windshield base.
- #1004 12 volt bulb (included).



**LIMITED QUANTITIES**

Order No.	Description	List Price	
7-51264	Length 11"	\$21.79	F0-5251000
7-3966	Spare Bulbs, 2 Per Pack	\$5.49	F0-4830000

Perko Coastal Series White All-Round Lights - Folding



- Black polymer top and base with clear fluted lens, frosted top.
- 360° reduced glare design.
- Fold-down, adjustable angle.
- 3/4" diameter anodized aluminum tube.
- 2 mile visibility.
- Use on power driven vessels under 20 meters in length.
- Uses #8 fasteners.
- 12 volt bulb included. 9 watts.



VERTICAL MOUNT

- Folds down 90° in either direction along the plane of attachment plate of the mount.
- Length 14-1/8". Base dimensions: 2-1/4" x 5/8".

Order No.	Mfg. No. / Description	List Price	
5315106	(1637 DPO CHR)	\$49.59	F0-1743000

HORIZONTAL MOUNT

- Folds down 90° in either direction opposite the plane of attachment plate of the mount.
- Length 14-3/4". Base dimensions: 2" x 1-1/2".

Order No.	Mfg. No. / Description	List Price	
5315105	(1634 DPO CHR)	\$48.99	F0-9243000

ACCESSORIES

Order No.	Mfg. No. / Description	List Price	
535318	(0239 DPO BLK) Black/Clear Globe	\$13.99	F0-9790000
537475	(0338 DP2 CLR) Spare Bulbs - 2 Per Pack	\$11.19	F0-3870000

Perko Alpha Series White All-Round Lights - Folding



- Black polymer top and collar with white translucent globe.
- Gold plated contacts.
- Fold-down, adjustable angle.
- 3/4" diameter anodized aluminum tube.
- 2 miles visibility.
- Use on sail or power driven vessels under 20 meters in length.
- Uses #8 fasteners.
- 12 volt bulb included. 11 watts.



VERTICAL MOUNT

- Folds down 90° in either direction along the plane of attachment plate of the mount.
- Length 15-1/2". Base dimensions: 2-1/4" x 5/8".

Order No.	Mfg. No. / Description	List Price	
532247	(1137 DPO CHR)	\$50.69	F0-8453000

HORIZONTAL MOUNT

- Folds down 90° in either direction opposite the plane of attachment plate of the mount.
- Length 15-5/8". Base dimensions: 2" x 1-1/2".

Order No.	Mfg. No. / Description	List Price	
532223	(1134 DPO CHR)	\$49.29	F0-0543000

ACCESSORIES

Order No.	Mfg. No. / Description	List Price	
535611	(0201 DPO WHT) White Translucent Globe	\$15.99	F0-9111000

Perko L.E.D. Combination Masthead/White All-Round Lights - Folding



- Black polymer top and base, zinc alloy with clear polymer lens.
- Gold plated contacts.
- Fold-down, adjustable angle.
- 3 mile visibility.
- Use on sail or power driven vessels under 20 meters in length.
- 3/4" diameter anodized aluminum tube.
- Uses #8 fasteners.
- 12 volt. 2.2 watts.



VERTICAL MOUNT - BASE DIMENSIONS: 2-1/4" X 5/8"

- Folds down 90° in either direction along the plane of attachment plate of the mount.

Order No.	Mfg. No. / Description	List Price	
532780	(1684 DPO CHR) Length 13-3/8"	\$195.79	F0-5073100

HORIZONTAL MOUNT - BASE DIMENSIONS: 2" X 1-1/2"

- Folds down 90° in either direction opposite the plane of attachment plate of the mount.

Order No.	Mfg. No. / Description	List Price	
532778	(1681 DPO CHR) Length 13-1/2"	\$195.79	F0-5073100

Electronics

Trolling Motors

Instruments

Electrical

Lighting

Anchor & Dock

Safety

Steering, Controls

Pumps

Fuel System

Seating & Pedestals

Trailering

Tops & Covers

Perform.

Propellers

Engine & Care

Cleaning & Care

Paint & Paint Acc.

Fun & Flotation

Topside Acc.

Cockpit & Deck

Hardware, Fasteners

Camouflage

Misc.

Comm.

All-Round Light - Folding

Hella 2010 Series All-Around Anchor Light - Folding



- Black housing.
- Featuring heavy duty anodized aluminium poles and impact resistant bases.
- Lamp pole can be adjusted through 180° and secured with locking collar.
- Includes a removable wedge for different surface cambers.
- 2 nautical mile visibility.
- USCG Approved, IMO Col Reg 72, ABYC A-16.
- 12 volt.



Order No.	Mfg. No. / Description	List Price	
4011152	(995002021) Length 8"	\$75.19	H0-1154000

Attwood All-Round Light - Folding



- Anti-glare.
- Black plastic pole with composite black cam-lock base.
- Black horizontal mount with rail mount adaptor.
- 2 mile, 360° visibility.
- For use on boats up to 39.4' (12 meters).
- Base dimensions: 3.50" x 1.52".
- 12 volt.

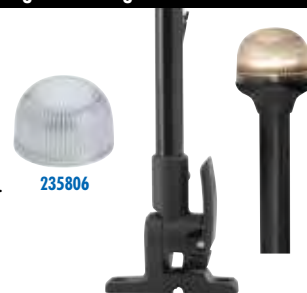

Order No.	Mfg. No. / Description	List Price	
235326	(5358-12-7) Length 12"	\$41.79	F0-5292000
235806	(912852-7) Spare Globe	\$4.59	F0-1230000

All-Round Light - Telescoping

Marpac L.E.D. All-Round Light - Telescoping



- Tough marine grade aluminum pole with stainless steel base.
- Adjustable head allows for correct alignment independent from the base.
- Certified USCG 2nm, for use on boats under 39.4' (12 meters).
- 360° visibility.
- Meets the stringent requirements for USCG, ABYC A-16 and IMO COLREG.
- Uses two #8 flat/oval head screws (Not included).
- No bulbs to replace - LED's are Surface Mounted Diodes (SMB). 12 volt.



LIMITED QUANTITIES

Order No.	Description	List Price	
7-6553	Length 26" - 48"	\$74.69	G0-4005000

Marpac L.E.D. All-Round Lights - Telescoping



- Water resistant.
- 3/4" anodized aluminum pole.
- Removes quickly from easy-to-install, standard 2 pin base.
- Certified USCG 2nm, for use on boats under 39.4' (12 meters).
- 360° visibility.
- Meets USCG and ABYC requirements.
- No bulbs to replace - LED's are Surface Mounted Diodes (SMB). 12 volt.



Order No.	Description	List Price	
7-6547	Length 26" - 48"	\$34.19	F0-3932000
7-6549	Length 34" - 60"	\$40.69	F0-8482000
7-6548	Length 40" - 72"	\$39.09	F0-6372000

All-Round Light - Fixed

Marpac L.E.D. All-Round Lights - Fixed



- Tough marine grade aluminum pole and base.
- Excellent for use on pontoon boats, hard tops and radar arches.
- Certified USCG 2nm, for use on boats under 39.4' (12 meters).
- 360° visibility.
- Meets the stringent requirements for USCG, ABYC A-16 and IMO COLREG.
- Uses two #8 flat/oval head screws (Not included).
- No bulbs to replace - LED's are Surface Mounted Diodes (SMB). 12 volt.



Order No.	Description	List Price	
7-6550	Length 4"	\$45.49	G0-8403000
7-6552	Length 7"	\$50.29	G0-9633000

Marpac L.E.D. All-Round Light - Fixed



- Water resistant.
- 3/4" anodized aluminum pole with UV stabilized plastic fittings.
- Certified USCG 2nm, for use on boats under 39.4' (12 meters).
- 360° visibility.
- No bulbs to replace - LED's are Surface Mounted Diodes (SMB). 12 volt.



Order No.	Description	List Price	
7-6544	Length 4"	\$15.09	G0-1101000

Marpac L.E.D. All-Round Light - Fixed



- 3/4" anodized aluminum pole.
- Fully sealed LED construction.
- Certified USCG 2nm, for use on boats under 39.4' (12 meters).
- 360° visibility.
- No bulbs to replace - LED's are Surface Mounted Diodes (SMB). 12 volt.



Order No.	Description	List Price	
7-51599	Length 5"	\$33.69	F0-8532000

Perko Fig. 1342 L.E.D. All-Round Light - Pipe Mount



- "Reduce glare" design.
- Black polymer and aluminum top with clear fluted lens and frosted globe.
- Pipe mount for 3/4" pipe.
- 2 mile visibility.
- Use on sail or power driven vessels under 20 meters in length.
- 3/4" diameter anodized aluminum tube.
- Length 5-3/8". Base OD: 1-1/2".
- 12 volt. 4.5 watts.



Order No.	Mfg. No. / Description	List Price	
534594	(1342 001 BLK)	\$295.89	F0-2170200

- Electronics
- Trolling Motors
- Instruments
- Electrical
- Lighting
- Anchor & Dock
- Safety
- Steering, Controls
- Pumps
- Fuel System
- Seating & Pedestals
- Trailering
- Tops & Covers
- Perform.
- Propellers
- Engine & Care
- Cleaning & Care
- Paint & Paint Acc.
- Fun & Flotation
- Topside Acc.
- Cockpit & Deck
- Hardware, Fasteners
- Camouflage
- Misc.
- Comm.

- Electronics
- Trolling Motors
- Instruments
- Electrical
- Lighting
- Anchor & Dock
- Safety
- Steering, Controls
- Pumps
- Fuel System
- Seating & Pedestals
- Trailing
- Tops & Covers
- Perform.
- Propellers
- Engine & Care
- Cleaning & Care
- Paint & Paint Acc.
- Fun & Flotation
- Topside Acc.
- Cockpit & Deck
- Hardware, Fasteners
- Camouflage
- Misc.
- Comm.

All-Round Light - Fixed

Marpac All-Round Light - Fixed



- Anodized aluminum pole and sturdy plastic base.
- Anti-glare lens.
- 2 mile visibility, 360°.
- For use on boats under 39.4' (12 meters).
- #1004 12 volt bulb (included).

**LIMITED QUANTITIES**

Order No.	Description	List Price	
7-51261	Length 8"	\$18.69	F0-8031000
7-51258	Replacement Globe	\$3.99	F0-9720000
7-3966	Spare Bulbs, 2 Per Pack	\$5.49	F0-4830000

Marpac All-Round Light - Fixed



- Water resistant.
- Certified USCG 2nm, for use on boats under 39.4' (12 meters).
- 360° visibility.
- Uses two #8 flat head screws (included).
- 12 volt.

Order No.	Description	List Price	
7-51266	Length 4"	\$7.19	G0-2840000

Perko Fig. 170 Alpha Series White All-Round Light - Fixed



- Black polymer top and collar with white translucent globe.
- Gold plated contacts.
- 3/4" diameter anodized aluminum tube.
- 2 miles visibility.
- Use on sail or power driven vessels under 20 meters in length.
- Base dimensions: 1" x 2-5/8".
- Uses #8 fasteners.
- 12 volt bulb included. 11 watts.

Order No.	Mfg. No. / Description	List Price	
533274	(0170 SWB DP1) Length 5-1/8"	\$30.19	F0-3112000
535611	(0201 DPO WHT) White Translucent Globe	\$15.99	F0-9111000

Perko Fig. 455 White All-Round Lights - Fixed



- Black polymer top and base with clear fresnel globe.
- Gold plated contacts.
- 2 mile visibility.
- Use on power driven vessels under 20 meters in length.
- 3/4" diameter anodized aluminum tube.
- Base OD 2-1/8".
- Uses #8 fasteners.
- 12 volt bulb included. 7 watts.

Order No.	Mfg. No. / Description	List Price	
538631	(0455 DP1 CHR) Length 5-5/8"	\$72.59	F0-1805000
538643	(0455 DP2 CHR) Length 13"	\$78.69	F0-8055000
536031	(0248 DPO CLR) Spare Globe	\$17.39	F0-7121000

Perko Stealth Series L.E.D. White All-Round Lights - Fixed



- Black polymer top and base with clear fluted lens.
- 360° reduce glare design.
- Fixed mount base.
- 2 mile visibility.
- Use on power driven vessels under 20 meters in length.
- 3/4" diameter anodized aluminum tube.
- Uses #8 fasteners.
- 12 volt. 1.5 watts.

BASE MOUNT

- Length 7-1/4". Base dimensions: 1" x 2-5/8".

Order No.	Mfg. No. / Description	List Price	
544660	(1608 DPO BLK)	\$95.19	F0-3666000

TOWER/ARCH MOUNT - MOUNTS ON 7/8" DIAMETER TUBING

- Serves as 360° all-round navigation light in the up position for nighttime boating or while at anchor and a cockpit courtesy light in the down position while at the dock. Stores Forward and out of the way for daytime skiing or boarding.
- Length 8-3/8". Base dimensions: 2" x 1-1/2".

Order No.	Mfg. No. / Description	List Price	
544684	(1609 DPO CHR)	\$109.79	F0-5867000

Perko Coastal Series White All-Round Lights - Fixed



- Black polymer top and base with clear fluted lens, frosted top.
- 360° reduced glare design.
- 3/4" diameter anodized aluminum tube.
- 2 mile visibility.
- Use on power driven vessels under 20 meters in length.
- Uses #8 fasteners.
- 12 volt bulb included. 9 watts.

BASE MOUNT

- Length 7-3/8". Base dimensions: 1" x 2-5/8".

Order No.	Mfg. No. / Description	List Price	
5315098	(1604 DPO CHR)	\$25.49	F0-4871000

TOWER/ARCH MOUNT

- Serves as 360° all-round navigation light in the up position for nighttime boating or while at anchor and a cockpit courtesy light in the down position while at the dock. Stores Forward and out of the way for daytime skiing or boarding.
- Mounts on 7/8" diameter tubing.
- Length 8". Base dimensions: 2" x 1-1/2".

Order No.	Mfg. No. / Description	List Price	
535178	(1607 DPO CHR)	\$71.79	F0-5205000

ACCESSORIES

Order No.	Mfg. No. / Description	List Price	
535318	(0239 DPO BLK) Black/Clear Globe	\$13.99	F0-9790000
537475	(0338 DP2 CLR) Spare Bulbs - 2 Per Pack	\$11.19	F0-3870000

All-Round Light - Fixed

Attwood All-Round Light - Fixed

- Frosted globe.
- Fixed base for use on pontoons, hard tops and radar arches.
- 3/4" diameter anodized aluminum pole.
- 2 mile, 360° visibility.
- For use on boats up to 39.4' (12 meters).
- Base dimensions: 2-1/2" long x 1" wide.
- Two countersunk holes for #10 fasteners.
- Includes: 9 watt wedge-base lamp. 12 volt.



Order No. Mfg. No. / Description List Price  
**235502** (5122-08-7) Length 8" **\$28.99** FO-9202000

Masthead/White All-Round Lights

Attwood LightArmor™ L.E.D. Anchor/Masthead Light - Folding



- LightArmor Anchor/Masthead navigation light engine
- Durable, anodized aluminum pole
- For use on boats up to 65' (20 meters).
- 3 mile, 360° visibility.
- Shock, corrosion and water proof electronics.
- Horizontal mount.
- Includes: LightArmor stainless steel fold-down base. Cam-lock bases include integrated wire-management. Easy, single-handed cam-lock operation.
- 12 volt.



Order No. Mfg. No. / Description List Price  
**235526** (7812-S-7) Length 12" **\$142.09** FO-6499000

**NEW PRODUCT**

Marpac Folding Combination Anchor/Stern All-Round Light - Folding



- High impact construction.
- Dual mount 180° fold down.
- Compact fold down design.
- Low profile base.
- 2 mile visibility, 360°.
- Stainless steel pole.
- 12 volt.



Order No. Mfg. No. List Price  
**7-51260** Length 10-1/2" **\$33.39** FO-7332000

Perko Combination Masthead/White All-Round Lights - Folding



- Black polymer top and base with zinc alloy, clear polymer lens.
- Gold plated contacts.
- 3 mile visibility.
- Use on sail or power driven vessels under 20 meters in length.
- 3/4" diameter anodized aluminum tube.
- Uses #8 fasteners.
- (2) 12 volt bulbs included. 10 watts (each compartment)

VERTICAL MOUNT - BASE DIMENSIONS: 2-1/4" X 5/8"

- Folds down 90° in either direction along the plane of attachment plate of the mount.

Order No. Mfg. No. / Description List Price  
**532691** (1184 DPO CHR) Length 14" **\$81.09** FO-6765000  
**535659** (1054 DPA CHR) Replacement Base **\$31.19** FO-3812000

HORIZONTAL MOUNT - BASE DIMENSIONS: 2" X 1-1/2"

- Folds down 90° in either direction opposite the plane of attachment plate of the mount.

Order No. Mfg. No. / Description List Price  
**532689** (1181 DPOCHR) Length 14-1/4" **\$81.09** FO-6765000  
**531640** (1052 DPA CHR) Replacement Base **\$31.19** FO-3812000

Perko Combination Masthead/White All-Round Light - Folding



- Black polymer top and base with clear polymer lens.
- Gold plated contacts.
- Fold-down, adjustable angle.
- 2 mile visibility.
- Use on power driven vessels under 12 meters in length.
- 3/4" diameter anodized aluminum tube.
- Uses #8 fasteners.
- (2) 12 volt bulbs included. 5 watts (each compartment)

**LIMITED QUANTITIES**

VERTICAL MOUNT - BASE DIMENSIONS: 2-1/4" X 5/8"

- Folds down 90° in either direction along the plane of attachment plate of the mount.

Order No. Mfg. No. / Description List Price  
**532995** (1284 DPO CHR) Length 13-1/8" **\$68.29** FO-0874000  
**535659** (1054 DPA CHR) Replacement Base **\$31.19** FO-3812000  
**535320** (0240 DPO LNS) Replacement Lens Assembly **\$19.39** FO-7531000  
**537471** (0338 DPA CLR) Spare Bulbs - 2 Per Pack **\$10.69** FO-8470000

HORIZONTAL MOUNT - BASE DIMENSIONS: 2" X 1-1/2"

- Folds down 90° in either direction opposite the plane of attachment plate of the mount.

Order No. Mfg. No. / Description List Price  
**532967** (1281 DPO CHR) Length 13-1/4" **\$68.29** FO-0874000  
**531640** (1052 DPA CHR) Replacement Base **\$31.19** FO-3812000  
**535320** (0240 DPO LNS) Replacement Lens Assembly **\$19.39** FO-7531000  
**537471** (0338 DPA CLR) Spare Bulbs - 2 Per Pack **\$10.69** FO-8470000

- Electronics
- Trolling Motors
- Instruments
- Electrical
- Lighting
- Anchor & Dock
- Safety
- Steering, Controls
- Pumps
- Fuel System
- Seating & Pedestals
- Trailer
- Tops & Covers
- Perform.
- Propellers
- Engine & Care
- Cleaning & Care
- Paint & Paint Acc.
- Fun & Flotation
- Topside Acc.
- Cockpit & Deck
- Hardware, Fasteners
- Camouflage
- Misc.
- Comm.

Masthead/White All-Round Lights

Perko L.E.D. Combination Masthead/White All-Round Light - Fixed



- Black polymer top and base, zinc alloy insert with clear polymer lens.
- Gold plated contacts.
- Fixed mount base.
- 3 mile visibility.
- Use on sail or power driven vessels under 20 meters in length.
- 3/4" diameter anodized aluminum tube.
- Base dimensions: 1" x 2-5/8".
- Uses #8 fasteners.
- 12 volt. 2.2 watts.

Electronics

Trolling Motors

Instruments

Electrical

Lighting

Anchor & Dock

Safety

Steering, Controls

Pumps

Fuel System

Seating & Pedestals

Trailering

Tops & Covers

Perform.

Propellers

Engine & Care

Cleaning & Care

Paint & Paint Acc.

Fun & Flotation

Topside Acc.

Cockpit & Deck

Hardware, Fasteners

Camouflage

Misc.

Comm.

Order No.	Mfg. No. / Description	List Price	
532805	(1683 DPO CHR) Length 3-3/8"	\$174.59	FO-1222100

Perko Combination Masthead/White All-Round Lights - Fixed



- Black polymer top and base with zinc alloy, clear polymer lens.
- Gold plated contacts.
- 3 mile visibility.
- Use on sail or power driven vessels under 20 meters in length.
- 3/4" diameter anodized aluminum tube.
- Base dimensions: 1" x 2-5/8".
- Uses #8 fasteners.
- (2) 12 volt bulbs included. 10 watts (each compartment)

**BASE MOUNT - BASE DIMENSIONS: 1" X 2-5/8"**

Order No.	Mfg. No. / Description	List Price	
532704	(1183 DPO CHR) Length 4"	\$59.49	FO-4614000
532728	(1196 DP2 CHR) Length 12-3/16"	\$72.19	FO-3505000

**BASE MOUNT - BASE DIMENSIONS: 3/4". SHORT POLE WITH PIGTAIL LEADS**

Order No.	Mfg. No. / Description	List Price	
532730	(1197 DPO CHR) Length 4-7/8"	\$49.19	FO-3443000

**ACCESSORIES**

Order No.	Mfg. No. / Description	List Price	
541739	(0071 DPO CLR) Spare Bulbs - 2 Per Pack	\$14.89	FO-2401000

Perko Glare Shield



- Can be installed without removing light.
- Black polymer.
- Dimensions: 6" x 4-5/16".
- For use with: 3/4" OD tubing.

Order No.	Mfg. No. / Description	List Price	
5315043	(1192 DPO BLK)	\$15.89	GO-5601000

LIMITED QUANTITIES

Perko Combination Masthead/White All-Round Lights - Fixed



- Black polymer top and base with clear polymer lens.
- Gold plated contacts.
- Fixed mount base.
- 2 mile visibility.
- Use on power driven vessels under 12 meters in length.
- 3/4" diameter anodized aluminum tube.
- Base dimensions: 1" x 2-5/8".
- Uses #8 fasteners.
- (2) 12 volt bulbs included. 5 watts (each compartment)



Order No.	Mfg. No. / Description	List Price	
532983	(1283 DPO BLK) Length 3"	\$48.69	FO-8043000
533202	(1236 DP2 BLK) Length 11-3/8"	\$57.89	FO-2504000
535320	(0240 DPO LNS) Replacement Lens Assembly	\$19.39	FO-7531000
537471	(0338 DP1 CLR) Spare Bulbs - 2 Per Pack	\$10.69	FO-8470000

Perko Combination Masthead/White All-Round Light - Plug-in



- Black polymer top and zinc alloy top with brass base.
- Stow-a-way plug-in pole.
- Two light compartments (Masthead/Anchor).
- Pole rake: 16°.
- 3/4" diameter anodized aluminum tube.
- 3 mile visibility.
- Use on sail or power driven vessels under 20 meters in length.
- Deck mount plug-in base with waterproof cover for base that attaches to deck mounted retainer when light is in place.
- Base dimensions: 3-3/8" x 2-1/4".
- Uses #8 fasteners.
- (2) 12 volt bulbs included.
- 10 watts (each compartment)

Order No.	Mfg. No. / Description	List Price	
532209	(1125 DP4 CHR) Length 35-7/8"	\$171.99	FO-9302100
541739	(0071 DPO CLR) Spare Bulbs - 2 Per Pack	\$14.89	FO-2401000

Attwood Anchor/Masthead Lights - Folding



- Black composite cam-lock base and anodized aluminum pole.
- Horizontal mount with rail adaptor.
- Robust design provides easy, single-handed cam-lock operation.
- 3 mile, 360° visibility.
- For use on boats up to 65.6' (20 meters).
- Installs with two required #10 fasteners.
- Base dimensions: 3.50" x 1.52".
- Uses (2) festoon-style 8-watt lamps.
- 12 volt.

Order No.	Mfg. No. / Description	List Price	
235511	(7201-P-7) Length 12"	\$72.59	FO-1805000
235510	(7202-P-7) Length 20"	\$81.69	FO-8175000

## Perko Pole Storage Clips



- Great for storing pole lights, gaffs, deck brushes and other boat accessories.
- Soft black polymer, UV stabilized.
- Dimensions: 3/4" x 2-1/4" x 1-5/8".
- Screw size: #10 P.H.

Order No.	Mfg. No. / Description	List Price	
<b>531827</b>	(0477 DPO BLK) For Pole OD: 3/4"	<b>\$8.29</b>	F0-0850000
<b>531816</b>	(0477 DP1 BLK) For Pole OD: 7/8"	<b>\$12.69</b>	F0-8880000

## Perko Fold-Down Adjustable Replacement Bases - Heavy Duty



- Chrome plated zinc alloy base 30° graduated adjustment increments.
- For poles less than 48" long.
- Complete with knob, end plug and adapter for "V" or flat mounting surfaces.
- Contains notch for through base wiring.
- Uses #8 fasteners.

## HORIZONTAL MOUNT. DIMENSIONS: 2" x 1-1/2".

Order No.	Mfg. No. / Description	List Price	
<b>531640</b>	(1052 DPA CHR) Fits Perko Figs. 1181 & 1281	<b>\$31.19</b>	F0-3812000

## VERTICAL MOUNT. DIMENSIONS: 2-1/4" x 5/8".

Order No.	Mfg. No. / Description	List Price	
<b>535659</b>	(1054 DPA CHR) Fits Perko Figs. 1184 & 1284	<b>\$31.19</b>	F0-3812000

## Perko Fold-Down Adjustable Replacement Base - Heavy Duty



- Chrome plated zinc alloy base 30° graduated adjustment increments.
- For poles less than 48" long.
- Complete with knob, end plug and adapter for "V" or flat mounting surfaces.
- Vertical mount.
- Does not contain notch for through base wiring.
- Dimensions: 2-1/4" x 5/8".
- Uses #8 fasteners.
- Fits Perko Figs. 1137 & 1637.

Order No.	Mfg. No. / Description	List Price	
<b>2821054</b>	(1054DPOCHR)	<b>\$30.59</b>	F0-1412000

## Perko Spare Lens for Bi-Color/Tri-Color Lights



- Lens for **534380** (1310 DPO CHR) and **535133** (1612 DP2 BLK).
- One piece lens. Red/green.
- Height 1", width 1-3/4".

Order No.	Mfg. No. / Description	List Price	
<b>536764</b>	(0283 DPA LNS)	<b>\$19.39</b>	F0-7531000

## Marpac Pole Light Storage Clips



- Resilient soft rubber clip holds standard 3/4" diameter poles.
- Ideal for storing and protecting plug-in pole lights.
- Base dimensions: 2-1/8" x 5/8".
- Sold 2 clips per package.

Order No.	Description	List Price	
<b>7-54096</b>	Pole Light Storage Clips	<b>\$4.39</b>	F0-7030000

## Perko Fold-Down Adjustable Replacement Bases - Standard Duty



- All black polymer base with 0° to 180° adjustment.
- For poles less than 18" long.
- Complete with knob, end plug and adapter for "V" or flat mounting surfaces.
- Contains notch for through base wiring.
- Universal mounting base - fits all fold-down series poles.
- Uses #8 fasteners.

## HORIZONTAL MOUNT. DIMENSIONS: 2" x 1-1/2".

Order No.	Mfg. No. / Description	List Price	
<b>531651</b>	(1052 DPB BLK)	<b>\$27.79</b>	F0-5491000

## VERTICAL MOUNT. DIMENSIONS: 2-1/4" x 5/8".

Order No.	Mfg. No. / Description	List Price	
<b>531663</b>	(1054 DPB BLK)	<b>\$25.99</b>	F0-9181000

## Marpac Globe for All-Round Lights



- Anti-glare lens.
- Fits standard all-round lights.

Order No.	Description	List Price	
<b>7-51258</b>	Globe	<b>\$3.99</b>	F0-9720000

## Perko Spare Lens for Bi-Color/Tri-Color Lights



- Lens for **543379** (0904 DPO STS), **544115** (0972 DPO CHR) and **544127** (0972 DPO STS).
- One piece lens. Red/green.
- Height 1-1/4", width 1-3/8".

Order No.	Mfg. No. / Description	List Price	
<b>536838</b>	(0296 DPO LNS)	<b>\$19.39</b>	F0-7531000

Electronics

Trolling Motors

Instruments

Electrical

Lighting

Anchor &amp; Dock

Safety

Steering, Controls

Pumps

Fuel System

Seating &amp; Pedestals

Trailer

Tops &amp; Covers

Perform.

Propellers

Engine &amp; Care

Cleaning &amp; Care

Paint &amp; Paint Acc.

Fun &amp; Flotation

Topside Acc.

Cockpit &amp; Deck

Hardware, Fasteners

Camouflage

Misc.

Comm.



Perko Spare 112-1/2° Lens for Side Lights



- Lens for **543998** (0963 DPO STS) and **543689** (0915 DPO STS).
- Set of 1 red and 1 green lens.
- Height 1", width 2-1/8".

Order No. Mfg. No. / Description List Price  
**536827** (0295 DPO LNS) **\$19.39** FO-7531000

Perko Spare Lens for Side Lights



- Lens for **533895** (1264 DPO CHR).
- Set of 1 red and 1 green lens.

Order No. Mfg. No. / Description List Price  
**533883** (1264 DPO LNS) **\$28.69** FO-8002000

Perko Spare 360° Lens for All-Round Lights



- Lens for Fig. 1236, 1281, 1283, 1284 Series.
- Black/clear.
- Height 1-1/8", 3" x 1-5/8" OD.

Order No. Mfg. No. / Description List Price  
**535320** (0240 DPO LNS) **\$19.39** FO-7531000

Perko Spare 112-1/2° Lens for Side Lights



- Lens for **543998** (0963 DPO STS) and **543689** (0915 DPO STS).
- Set of 1 red and 1 green lens.
- Height 1", width 1-9/16".

Order No. Mfg. No. / Description List Price  
**536737** (0281 DPA LNS) **\$19.39** FO-7531000

Perko Spare 360° Globe for All-Round Lights



- Globe for Fig. 1440, 1445 Series.
- Black/clear.
- Height 2", 2-1/4" OD.

Order No. Mfg. No. / Description List Price  
**535306** (0238 DPO BLK) **\$13.99** FO-9790000

Perko Spare 360° Globe for All-Round Lights



- Globe for Fig. 0170, 1134, 1137, 1138, 1301, 1400, 1403, 1404, 1611 Series.
- White.
- Height 3", 1-1/2" ID, 1-9/16" OD.

Order No. Mfg. No. / Description List Price  
**535611** (0201 DPO WHT) **\$15.99** FO-9111000

Perko Spare 112-1/2° Lens for Side Lights



- Lens for **543948** (0955 DPO STS).
- Set of 1 red and 1 green lens.
- Height 1-1/4".

Order No. Mfg. No. / Description List Price  
**536361** (0260 DPO LNS) **\$19.39** FO-7531000

Perko Spare 360° Globe for All-Round Lights



- Globe for Fig. 1460, 1465, 1470, 1604, 1607, 1637, 1634 Series.
- Black/clear.
- Height 2", 2-1/4" OD.

Order No. Mfg. No. / Description List Price  
**535318** (0239 DPO BLK) **\$13.99** FO-9790000

Perko Spare 360° Globe for All-Round Lights



- Globe for **538631** (0455 DP1 CHR), **538643** (0455 DP2 CHR) and **533302** (1209 DP3 CHR)
- Clear.
- Height 2-1/2", 1-11/16" ID, 2" OD.

Order No. Mfg. No. / Description List Price  
**536031** (0248 DPO CLR) **\$17.39** FO-7121000

Attwood Replacement Lens for All-Round Lights



- 360° globe.
- For early Attwood models.
- Fits: 6700 Series.

Order No. Mfg. No. / Description List Price  
**235792** (6724-05) Sold per bulk **\$3.49** HO-9020000  
**2350125** (6724-05-1) Sold per display package **\$8.59** FO-1060000

Attwood Replacement Lens for All-Round Lights



- Anti-glare.
- For pole lights, new style.
- Fits: 5300, 5310, 5320, 5330 and 5340.

Order No. Mfg. No. / Description List Price  
**235806** (912852-7) **\$4.59** FO-1230000

Attwood Replacement Frosted Globe for All-Round Lights



- For pole lights, new style and early Attwood models.
- Fits: 5100, 5110, 7100, 7101, 7105, 7109 and 7205.
- Internal threads: 1-5/8".

Order No. Mfg. No. / Description List Price  
**235805** (9101787) **\$7.49** FO-4250000

- Electronics
- Trolling Motors
- Instruments
- Electrical
- Lighting
- Anchor & Dock
- Safety
- Steering, Controls
- Pumps
- Fuel System
- Seating & Pedestals
- Trailering
- Tops & Covers
- Perform.
- Propellers
- Engine & Care
- Cleaning & Care
- Paint & Paint Acc.
- Fun & Flotation
- Topside Acc.
- Cockpit & Deck
- Hardware, Fasteners
- Camouflage
- Misc.
- Comm.

**Perko Fig. 309B Series All-Round Lights - Pipe Mount**



- Plain cast bronze.
- Medium screw base type electrical socket.
- 2 mile visibility.
- Certified for replacement use only.
- Use on power driven vessels under 20 meters in length.
- Overall height 6-1/2".
- Tapped pipe size 1/2".
- Requires frosted medium screw bulb (Not included).



529620

Order No.	Mfg. No. / Description			List Price	
527880	(0309 B00 PLB) White	15 watt Bulb		\$255.99	F0-9197100
527892	(0309 R00 PLB) Red	25 watt Bulb		\$255.99	F0-9197100
527905	(0309 G00 PLB) Green	25 watt Bulb		\$255.99	F0-9197100
529620	(0226) Medium Screw Base Socket			\$18.59	F0-1031000

**Perko Fig. 108 Series All-Round Navigation Light Sets**



- Black polymer with festoon type electrical socket.
- Base is tapped for 1/2" pipe or can be removed for surface mounting with #10 fasteners.
- 2 mile visibility. Visibility arc: 360°.
- Use on power driven vessels under 20 meters in length.
- Height 6", base OD 3-1/8", lens height 5".
- For 12, 24 or 32 volt bulbs. Bulbs not included.
- Note: White light (527828) supplied with a grey tinted globe.

Order No.	Mfg. No. / Description		List Price	
527828	(0108 000 BLK) White		\$113.29	F0-0397000
527830	(0108 G00 BLK) Green		\$113.29	F0-0397000
527842	(0108 R00 BLK) Red		\$113.29	F0-0397000
541638	(0070DP1CLR) Spare Bulbs 12V (2 Per Pack)		\$15.99	F0-9111000
541501	(0067 DP2 CLR) Spare Bulbs 24V (2 Per Pack)		\$19.49	F0-4631000
541640	(0070 DP2 CLR) Spare Bulbs 32V (2 Per Pack)		\$17.19	F0-3021000

**Perko Fig. 106 Series Spare Globes**



- Spare globes for Perko Figs. 108, 112 and 309 All-Round Lights.

Order No.	Mfg. No. / Description		List Price	
529000	(0106 000 WHT) White		\$92.39	F0-7646000
529012	(0106 000 GRN) Green		\$92.39	F0-7646000
529024	(0106 000 YLW) Yellow		\$92.39	F0-7646000
529036	(0106 000 RED) Red		\$92.39	F0-7646000

**Perko Fig. 112B All-Round Light - Fixed Mount**



529620

- Plain cast bronze.
- Medium screw base type electrical socket.
- 2 mile visibility.
- Certified for replacement use only.
- Use on power driven vessels under 20 meters in length.
- Overall height 8-3/4", base OD 3-1/8".
- Uses #8 fasteners.
- Requires 15 watt frosted medium screw bulb (Not included).

Order No.	Mfg. No. / Description	List Price	
527854	(0112 B00 PLB)	\$340.09	F0-6083200
529620	(0226) Medium Screw Base Socket	\$18.59	F0-1031000

**Perko Figs. 109, 110 and 111 Series Navigation Light Sets**



527715

527703

527690

527727

527739

- Black polymer.
- Use on power driven vessels under 20 meters in length.
- Overall height 5-1/4".
- Lens height 4-1/4".
- Uses #10 fasteners.
- For 12 or 24 volt bulbs. Bulbs not included.

Order No.	Mfg. No. / Description	Visibility (Arc)	List Price	
527703	(0109 G00 BLK) Green Side	2 Mile (112-1/2°)	\$125.09	F0-6578000
527690	(0109 R00 BLK) Red Side	2 Mile (112-1/2°)	\$125.09	F0-6578000
527715	(0110 000 BLK) White Masthead	3 Mile (225°)	\$125.09	F0-6578000
527727	(0111 000 BLK) White Stern	2 Mile (135°)	\$125.09	F0-6578000
527739	(0111 M00 BLK) Yellow Towing	2 Mile (135°)	\$125.09	F0-6578000

**SPARE BULBS (2 PER PACK)**

Order No.	Mfg. No. / Description	List Price	
541638	(0070DP1CLR) 12 volt	\$15.99	F0-9111000
541501	(0067 DP2 CLR) 24 volt	\$19.49	F0-4631000

- Electronics
- Trolling Motors
- Instruments
- Lighting
- Anchor & Dock
- Safety
- Steering, Controls
- Pumps
- Fuel System
- Seating & Pedestals
- Trailering
- Tops & Covers
- Perform.
- Propellers
- Engine & Care
- Cleaning & Care
- Paint & Paint Acc.
- Fun & Flotation
- Topside Acc.
- Cockpit & Deck
- Hardware, Fasteners
- Camouflage
- Misc.
- Comm.

Perko Fig. 200 Series Navigation Light Sets



- Electronics █
- Trolling Motors █
- Instruments █
- Electrical █

Lighting

- Anchor & Dock █
- Safety █
- Steering, Controls █
- Pumps █
- Fuel System █
- Seating & Pedestals █
- Trailering █

- Black polymer.
- Use on sail or power driven vessels under 20 meters in length.
- Base mount with #10 fasteners or use **535840** (222 DPO BLK) pipe mounting bracket.
- Height: 4-7/8", Base OD: 3-5/16".
- Spare bulbs for **535646** and **535652** - Use Perko Fig. 375 12 volt bulb (**528503**).
- Spare bulbs for **535640**, **535641** and **535645** - Use Perko Fig. 375 12 volt bulb (**528515**).
- 12 volt bulb included.

Order No.	Mfg. No.	Description	Visibility Mile	Visibility Arc	List Price	
<b>535640</b>	(0200 SDB DP1)	Green Side	2	112-1/2°	<b>\$147.99</b>	F0-9530100
<b>535641</b>	(0200 PBO DP1)	Red Side	2	112-1/2°	<b>\$147.99</b>	F0-9530100
<b>535645</b>	(0200 MBO DP1)	White Masthead	3	225°	<b>\$147.99</b>	F0-9530100
<b>535646</b>	(0200 SNB DP1)	White Stern	2	135°	<b>\$147.99</b>	F0-9530100
<b>535652</b>	(0200 SWB DP1)	White All-Round	2	360°	<b>\$147.99</b>	F0-9530100
<b>529618</b>	(0093)	Replacement Bulb Socket			<b>\$33.09</b>	F0-6132000

Perko Fig. 222 Pipe Mounting Bracket



- Propellers █
- Engine & Care █
- Cleaning & Care █
- Paint & Paint Acc. █

- Black polymer.
- Screws and soft black mounting gasket for mounting bracket to light.
- Overall OD 3-5/16".

Order No.	Mfg. No. / Description	List Price	
<b>535840</b>	(0222 DPO BLK)	<b>\$17.39</b>	F0-7121000

Perko Fig. 375 Double Contact Bayonet Indexing Base Bulbs



- Topside Acc. █
- Cockpit & Deck █
- Hardware, Fasteners █
- Camouflage █
- Misc. █
- Comm. █

Order No.	Mfg. No. / Description	List Price	
<b>528503</b>	(0375 12V 10W) 12 volt	10 watt .83 amp	<b>\$50.49</b> F0-4353000
<b>528515</b>	(0375 12V 25W) 12 volt	25 watt 2.08 amp	<b>\$55.49</b> F0-4883000
<b>528527</b>	(0375 24V 25W) 24 volt	25 watt 1.04 amp	<b>\$54.59</b> F0-1283000
<b>528539</b>	(0375 32V 25W) 32 volt	25 watt .78 amp	<b>\$68.59</b> F0-1084000

Perko Fig. 1377 - 1380 Series Single L.E.D. Navigation Light Sets



- Black polymer.
- Pre-wired with 3' of 18/3-SO cable.
- Translucent color specific insert on top of light for easy identification.
- For use on vessels 20 meters to 50 meters in length.
- Height overall: 6", vertical height: 3-1/2".
- Uses 1/4" fasteners.
- LED: Operates on 120/240 VAC system.

Order No.	Mfg. No.	Description	Visibility Mile	Visibility Arc	List Price	
<b>526154</b>	(1377 G00 BLK)	Green Side	2	112-1/2°	<b>\$698.59</b>	B0-3782600
<b>526159</b>	(1377 R00 BLK)	Red Side	2	112-1/2°	<b>\$698.59</b>	B0-3782600
<b>526164</b>	(1378 000 BLK)	White Masthead	5	225°	<b>\$814.39</b>	B0-5923700
<b>526169</b>	(1379 000 BLK)	White Stern	2	135°	<b>\$698.59</b>	B0-3782600
<b>526174</b>	(1379 M00 BLK)	Yellow Towing	2	135°	<b>\$698.59</b>	B0-3782600
<b>526179</b>	(1380 000 BLK)	White All-Round	2	360°	<b>\$698.59</b>	B0-3782600
<b>526184</b>	(1380 G00 BLK)	Green All-Round	2	360°	<b>\$698.59</b>	B0-3782600
<b>526189</b>	(1380 R00 BLK)	Red All-Round	2	360°	<b>\$698.59</b>	B0-3782600

Perko Fig. 309A Series Pipe Mount All-Round Light Sets



- Plain cast bronze.
- Complete with double contact electrical socket.
- 2 mile visibility.
- For use on vessels 20 meters to 50 meters in length.
- Overall height 6-1/2", tapped pipe size 1/2".
- Bulbs not included.

Order No.	Mfg. No. / Description	List Price	
<b>524822</b>	(0309 A00 PLB) White	<b>\$256.69</b>	D0-5350200
<b>524834</b>	(0309 RAO PLB) Red	<b>\$256.69</b>	D0-5350200
<b>528387</b>	(0374 001 CLR) Spare Bulbs 12V	<b>\$71.69</b>	F0-8105000
<b>528399</b>	(0374 002 CLR) Spare Bulbs 24V	<b>\$71.69</b>	F0-8105000
<b>528402</b>	(0374 003 CLR) Spare Bulbs 32V	<b>\$71.69</b>	F0-8105000
<b>528414</b>	(0374 004 CLR) Spare Bulbs 120V	<b>\$79.89</b>	F0-2955000

Perko Figs. 1127 - 1130 Series Navigation Light Sets



- Black polymer.
- Pre-wired double contact socket and 3' of 16/3-50 cable.
- Watertight access cap for rebulbing and cleaning.
- For use on vessels 20 meters to 50 meters in length.
- UL Standard 1104, 72 COLREGS and US inland rules.
- Height overall: 7-1/2", height lens: 4-1/2".
- Uses 1/4" fasteners.
- Bulbs: 12, 24, 32 or 120 volt (Not included). Use Perko Fig. 374 Double Contact Bayonet Bulbs.

\*White lights have grey tinted lens.

Order No.	Mfg. No.	Description	Visibility Mile	Visibility Arc	List Price	
525901	(1127 GAO BLK)	Green Side	2	112-1/2°	\$221.19	D0-5967100
525913	(1127 RAO BLK)	Red Side	2	112-1/2°	\$221.19	D0-5967100
525937	(1128 A00 BLK)	White Masthead	5	225°	\$221.19	D0-5967100
525951	(1129 A00 BLK)	White Stern*	2	135°	\$221.19	D0-5967100
525963	(1129 MA0 BLK)	Yellow Towing	2	135°	\$221.19	D0-5967100
525987	(1130 A00 BLK)	White All-Round*2	360°	360°	\$221.19	D0-5967100
525999	(1130 GAO BLK)	Green All-Round	2	360°	\$221.19	D0-5967100
526105	(1130 RAO BLK)	Red All-Round	2	360°	\$221.19	D0-5967100

SPARE LENS AND ACCESSORIES

Order No.	Mfg. No. / Description	List Price	
535419	(0249 000 RED) Spare Red Lens	\$153.99	A0-9935100
535421	(0249 000 GRN) Spare Green Lens	\$153.99	A0-9935100
535433	(0249 000 GRY) Spare Gray Lens	\$153.99	A0-9935100
529466	(0134) Spare Double Contact Socket	\$27.59	A0-9572000
529860	(1105 000 BLK) Spare Access Cap with Chain	\$36.59	A0-9563000
529872	(1119) Spare O-Ring for Cap	\$6.09	A0-9060000

IMPORTANT BULB DATA

- To comply with UL Standard A-1104 (A.B.Y.C.), these lights must use a Perko Fig. 374 bulb.

REPLACEMENT BULBS - CLEAR

Order No.	Mfg. No. / Description	List Price	
528387	(0374 001 CLR) 12 volt 30 watt	\$71.69	F0-8105000
528399	(0374 002 CLR) 24 volt 30 watt	\$71.69	F0-8105000
528402	(0374 003 CLR) 32 volt 30 watt	\$71.69	F0-8105000
528414	(0374 004 CLR) 120 volt 30 watt	\$79.89	F0-2955000

Perko Figs. 1150, 1151 and 1152 Series Navigation Light Sets



- Sheet metal, preprimed galvanized steel.
- Medium prefocus socket.
- Watertight terminal tube for 16/3-50 cable.
- Watertight access cap for rebulbing and cleaning.
- For use on vessels 20 meters to 50 meters in length.
- UL Standard 1104, 72 COLREGS and US inland rules.
- Height overall: 11-1/2", height lens: 6-3/4".
- Uses 1/4" fasteners.
- Bulb: 120 volt only (Not included). Use Perko Fig. 342 Medium Prefocus Bulbs.

Order No.	Mfg. No.	Description	Visibility Mile	Visibility Arc	List Price	
524656	(1150 GE1 GAL)	Green Side	2	112-1/2°	\$531.19	A0-9113500
524668	(1150 RE1 GAL)	Red Side	2	112-1/2°	\$531.19	A0-9113500
524682	(1151 E01 GAL)	White Masthead	5	225°	\$563.79	A0-9736500
524707	(1152 E01 GAL)	White Stern	2	135°	\$563.79	A0-9736500

SPARE ACCESSORIES

Order No.	Mfg. No. / Description	List Price	
529404	(0347 A00) Spare Medium Prefocus Socket	\$67.69	A0-9676000
529860	(1105 000 BLK) Spare Access Cap with Chain	\$36.59	A0-9563000
529872	(1119) Spare O-Ring for Cap	\$6.09	A0-9060000
528286	(0342 004 CLR) Spare Bulb - 120 volt, 60 watt	\$51.99	D0-9514000

Perko Fig. 1150 Series Navigation Light Set



- Sheet metal, preprimed galvanized steel.
- Medium prefocus socket.
- Watertight terminal tube for 16/3-50 cable.
- Watertight access cap for rebulbing and cleaning.
- For use on vessels over 20 meters in length.
- UL Standard 1104, 72 COLREGS and US inland rules.
- Height overall: 13-1/2", height lens: 7-1/2".
- Visibility miles: 3, visibility arc: 112-1/2°.
- Uses 1/4" fasteners.
- Bulb: 120 volt only (Not included). Use Perko Fig. 342 Medium Prefocus Bulbs.

Order No.	Mfg. No. / Description	List Price	
524353	(1150 GE2 GAL) Green Side	\$399.00	Z0-0099300

LIMITED QUANTITIES

- Electronics
- Trolling Motors
- Instruments
- Electrical
- Lighting
- Anchor & Dock
- Safety
- Steering, Controls
- Pumps
- Fuel System
- Seating & Pedestals
- Trailer
- Tops & Covers
- Perform.
- Propellers
- Engine & Care
- Cleaning & Care
- Paint & Paint Acc.
- Fun & Flotation
- Topside Acc.
- Cockpit & Deck
- Hardware, Fasteners
- Camouflage
- Misc.
- Comm.

- Electronics
- Trolling Motors
- Instruments
- Electrical
- Lighting**
- Anchor & Dock
- Safety
- Steering, Controls
- Pumps
- Fuel System
- Seating & Pedestals
- Trailing
- Tops & Covers
- Perform.
- Propellers
- Engine & Care
- Cleaning & Care
- Paint & Paint Acc.
- Fun & Flotation
- Topside Acc.
- Cockpit & Deck
- Hardware, Fasteners
- Camouflage
- Misc.
- Comm.

**Perko Figs. 1369 - 1374 Series Single Lens Navigation Light Sets**



- Lightweight but durable fiber-filled black polymer.
- Pre-wired medium prefocus socket.
- Includes: (1) 3' length of 16/3-SO cable through watertight terminal tubes.
- Watertight access cap for rebulbing and cleaning.
- For use on vessels over 20 meters in length.
- UL Standard 1104, 72 COLREGS and US inland rules.
- Height overall: 9-1/4", height lens: 6-3/4".
- Mounting bolt size: 3/8".
- Bulbs: 24, 120 or 220 volt (Not included). Use Perko Fig. 342 Medium Prefocus Bulbs. Rough service bulbs are available.

\*White lights have grey tinted lens.

Order No.	Mfg. No.	Description	Visibility Mile	Visibility Arc	List Price	
523438	(1372 GEO BLK)	Green Side	3	112-1/2°	\$365.29	A0-9256300
523440	(1372 REO BLK)	Red Side	3	112-1/2°	\$365.29	A0-9256300
523452	(1373 E00 BLK)	White Masthead	6	225°	\$365.29	A0-9256300
523464	(1374 E00 BLK)	White Stern*	3	135°	\$365.29	A0-9256300
523476	(1374 MEO BLK)	Yellow Towing	3	135°	\$365.29	A0-9256300
523488	(1369 E00 BLK)	White All-Round*	3	360°	\$350.99	A0-9905300
523490	(1370 REO BLK)	Red All-Round	3	360°	\$350.89	A0-9805300

**REPLACEMENT BULBS - CLEAR**

Order No.	Mfg. No. / Description	24 volt	55 watt	List Price	
528289	(0342 024 CLR)	24 volt	55 watt	\$87.49	D0-9996000
528286	(0342 004 CLR)	120 volt	60 watt	\$51.99	D0-9514000
528292	(0342 220 CLR)	220 volt	65 watt	\$73.39	D0-1785000

**REPLACEMENT BULBS - DESIGNED FOR ROUGH SERVICE**

Order No.	Mfg. No. / Description	120 volt	60 watt	List Price	
528298	(0342 RS4 CLR)	120 volt	60 watt	\$76.69	D0-5316000

**IMPORTANT BULB DATA**

• To comply with UL Standard A-1104 (A.B.Y.C.), these lights must be used with the following Perko bulbs: 24 volt use - 528289 (342 024 CLR) bulb, 120 volt use 528286 (342 004 CLR) bulb or 528298 (342 RS4 CLR) bulb when a "Rough Service" bulb is required and 220 volt use 528292 (342 220 CLR) bulb.

**Perko Figs. 1364 - 1368 Series Double Lens Navigation Light Sets**



- Lightweight but durable fiber-filled black polymer.
- Pre-wired medium prefocus socket.
- Includes: (2) 3' lengths of 16/3-SO cable through watertight terminal tubes.
- Watertight access cap for rebulbing and cleaning.
- For use on vessels over 20 meters in length.
- UL Standard 1104, 72 COLREGS and US inland rules.
- Height overall: 17-1/4", height lens: 6-3/4".
- Mounting bolt size: 3/8".
- Bulbs: 24, 120 or 220 volt (Not included). Use Perko Fig. 342 Medium Prefocus Bulbs. Rough service bulbs are available.

\*White lights have grey tinted lens.

Order No.	Mfg. No.	Description	Visibility Mile	Visibility Arc	List Price	
523351	(1364 GEO BLK)	Green Side	3	112-1/2°	\$488.39	A0-9388400
523363	(1364 REO BLK)	Red Side	3	112-1/2°	\$488.39	A0-9388400
523375	(1365 E00 BLK)	White Masthead	6	225°	\$488.39	A0-9388400
523387	(1366 E00 BLK)	White Stern*	3	135°	\$488.39	A0-9388400
523399	(1366 MEO BLK)	Yellow Towing	3	135°	\$488.39	A0-9388400
523402	(1367 E00 BLK)	White All-Round*	3	360°	\$468.69	A0-9686400
523414	(1368 GEO BLK)	Green All-Round	3	360°	\$468.69	A0-9686400
523426	(1368 REO BLK)	Red All-Round	3	360°	\$468.69	A0-9686400

**REPLACEMENT BULBS - CLEAR**

Order No.	Mfg. No. / Description	24 volt	55 watt	List Price	
528289	(0342 024 CLR)	24 volt	55 watt	\$87.49	D0-9996000
528286	(0342 004 CLR)	120 volt	60 watt	\$51.99	D0-9514000
528292	(0342 220 CLR)	220 volt	65 watt	\$73.39	D0-1785000

**REPLACEMENT BULBS - DESIGNED FOR ROUGH SERVICE**

Order No.	Mfg. No. / Description	120 volt	60 watt	List Price	
528298	(0342 RS4 CLR)	120 volt	60 watt	\$76.69	D0-5316000

**IMPORTANT BULB DATA**

• To comply with UL Standard A-1104 (A.B.Y.C.), these lights must be used with the following Perko bulbs: 24 volt use - 528289 (342 024 CLR) bulb, 120 volt use 528286 (342 004 CLR) bulb or 528298 (342 RS4 CLR) bulb when a "Rough Service" bulb is required and 220 volt use 528292 (342 220 CLR) bulb.

**Perko Figs. 1169 - 1174 Series Single Lens Navigation Light Sets**



523919



523882

- Heavy duty cast bronze.
- Pre-wired medium prefocus socket.
- Includes: (1) 3' length of 16/3-SO cable through a watertight terminal tube.
- Watertight access cap for rebulbing and cleaning.
- For use on vessels over 20 meters in length.
- UL Standard 1104, 72 COLREGS and US inland rules.
- Height overall: 9-1/4", height lens: 6-3/4".
- Mounting bolt size: 3/8".
- Bulb: 120 volt only (Not included). Use Perko Fig. 342 Medium Prefocus Bulbs. Rough service bulbs are available.

\*White lights have grey tinted lens.

Order No.	Mfg. No.	Description	Visibility Mile	Visibility Arc	List Price	
523882	(1169 E00 PLB)	White All-Round*	3	360°	\$679.89	A0-9897600
523919	(1170 RE0 PLB)	Red All-Round	3	360°	\$679.89	A0-9897600

**SPARE ACCESSORIES**

Order No.	Mfg. No. / Description	List Price	
529808	(1133) Spare Lens Retaining Clip with Bolt	\$20.39	A0-9302000
529810	(1143) Spare Lens Gasket	\$9.69	A0-9690000
529860	(1105 000 BLK) Spare Access Cap with Chain	\$36.59	A0-9563000
529872	(1119) Spare O-Ring for Cap	\$6.09	A0-9060000

**REPLACEMENT BULBS - 120 volt, 60 watt**

Order No.	Mfg. No. / Description	List Price	
528286	(0342 004 CLR) Clear	\$51.99	D0-9514000
528298	(0342 RS4 CLR) Rough Service	\$76.69	D0-5316000

**Perko Spare 360° Lenses for All-Round Lights**



- Fits 1169-1174 and 1164-1168 Series Navigation Lights.
- Overall height 6-3/4". Diameter opening: 5-1/8".

Order No.	Mfg. No. / Description	List Price	
528807	(0261 001 CLR) White	\$134.59	A0-9543100
528818	(0261 001 GRN) Green	\$134.59	A0-9543100
528820	(0261 001 YLW) Yellow	\$134.59	A0-9543100
528832	(0261 001 RED) Red	\$134.59	A0-9543100

**Perko Fig. 303 Dual Medium Prefocus Socket Assembly**



- Phenolic. 250 volts, 1,000 watts.
- Prewired with two medium prefocus sockets.
- For use in 1164 Series double lens lights.
- Overall height 3-7/8", overall width 3-7/8".

Order No.	Mfg. No. / Description	List Price	
529428	(0303)	\$186.59	A0-9568100
529430	(0303 A00) Male Plug Only	\$14.39	A0-9341000
529442	(0303 B00) Female Socket Only	\$11.59	A0-9511000

**Perko Figs. 1164 - 1168 Series Double Lens Navigation Light Sets**



523591



523577



523503



523515

- Heavy duty cast bronze.
- Pre-wired medium prefocus socket in each compartment.
- Includes: (2) 3' length of 16/3-SO cable through a watertight terminal tubes.
- Watertight access cap for rebulbing and cleaning.
- For use on vessels over 20 meters in length.
- UL Standard 1104, 72 COLREGS and US inland rules.
- Height overall: 17-1/4", height lens: 6-3/4".
- Mounting bolt size: 3/8".
- Bulb: 120 volt only (Not included). Use Perko Fig. 342 Medium Prefocus Bulbs. Rough service bulbs are available.

\*White lights have grey tinted lens.

Order No.	Mfg. No.	Description	Visibility Mile	Visibility Arc	List Price	
523503	(1164 GEO PLB)	Green Side	3	112-1/2°	\$1,084.89	A0-9848010
523515	(1164 RE0 PLB)	Red Side	3	112-1/2°	\$1,084.89	A0-9848010
523541	(1165 E00 PLB)	White Masthead	6	225°	\$1,084.89	A0-9848010
523565	(1166 E00 PLB)	White Stern*	3	135°	\$1,084.89	A0-9848010
523577	(1166 ME0 PLB)	Yellow Towing	3	135°	\$1,084.89	A0-9848010
523591	(1167 E00 PLB)	White All-Round*	3	360°	\$1,068.99	A0-9986010

**SPARE ACCESSORIES**

Order No.	Mfg. No. / Description	List Price	
529808	(1133) Spare Lens Retaining Clip with Bolt	\$20.39	A0-9302000
529810	(1143) Spare Lens Gasket	\$9.69	A0-9690000
529860	(1105 000 BLK) Spare Access Cap with Chain	\$36.59	A0-9563000
529872	(1119) Spare O-Ring for Cap	\$6.09	A0-9060000

**REPLACEMENT BULBS - 120 volt, 60 watt**

Order No.	Mfg. No. / Description	List Price	
528286	(0342 004 CLR) Clear	\$51.99	D0-9514000
528298	(0342 RS4 CLR) Rough Service	\$76.69	D0-5316000

- Electronics
- Trolling Motors
- Instruments
- Electrical
- Lighting
- Anchor & Dock
- Safety
- Steering, Controls
- Pumps
- Fuel System
- Seating & Pedestals
- Trailering
- Tops & Covers
- Perform.
- Propellers
- Engine & Care
- Cleaning & Care
- Paint & Paint Acc.
- Fun & Flotation
- Topside Acc.
- Cockpit & Deck
- Hardware, Fasteners
- Camouflage
- Misc.
- Comm.

**Perko Fig. 1129 Panama Canal Blue Steering Light**



- Black polymer.
- Pre-wired double contact socket with 3' of 16/3-SJO cable.
- For use on vessels of any length.
- Height overall: 7-1/2", height lens: 4-1/4" .
- Visibility arc 135° .
- Bulb: 12, 24, 32 or 120 volt (Not included).

Order No.	Mfg. No. / Description	List Price
<b>525975</b>	(1129 BAO BLK)	<b>\$368.09</b> D0-7449200

**SPARE ACCESSORIES**

Order No.	Mfg. No. / Description	List Price
<b>529466</b>	(0134) Spare Double Contact Socket	<b>\$27.59</b> A0-9572000
<b>529860</b>	(1105 000 BLK) Spare Access Cap with Chain	<b>\$36.59</b> A0-9563000
<b>529872</b>	(1119) Spare O-Ring for Cap	<b>\$6.09</b> A0-9060000

**REPLACEMENT BULBS - CLEAR**

Order No.	Mfg. No. / Description	List Price
<b>528387</b>	(0374 001 CLR) 12 volt 30 watt	<b>\$71.69</b> F0-8105000
<b>528399</b>	(0374 002 CLR) 24 volt 30 watt	<b>\$71.69</b> F0-8105000
<b>528402</b>	(0374 003 CLR) 32 volt 30 watt	<b>\$71.69</b> F0-8105000
<b>528414</b>	(0374 004 CLR) 120 volt 30 watt	<b>\$79.89</b> F0-2955000

**IMPORTANT BULB DATA**

- To comply with Panama Canal Requirements this light must use a Perko Fig. 374 bulb.

**Barge Lights**



Order No.	Mfg. No. / Description	List Price
<b>273209</b>	(100MD46LA) Amber	<b>\$163.89</b> B0-0574100
<b>273211</b>	(100MD46LCL) Clear	<b>\$163.89</b> B0-0574100
<b>273223</b>	(100MD46LRD) Red	<b>\$163.89</b> B0-0574100
<b>273235</b>	(100MD46LGR) Green	<b>\$163.89</b> B0-0574100

**McDermott L.E.D. Anchor Lights**



- All around white lights with 1 mile visibility.
- Meets USCG regulations for anchor lights.
- Battery and solar powered options.

Order No.	Mfg. No. / Description	List Price
<b>S/O</b>	(ANCHORSP) Straps to 6V Battery	
<b>453201</b>	(ANCHOR-RRDLX) (1) 6V Battery, Magnetic Base	<b>\$117.59</b> B0-3850100
<b>S/O</b>	(ANCHORDLXBH) (1) 6V Battery, Magnetic Base, Handle	
<b>S/O</b>	(ANCHOR888DLX) (2) 6V Battery, Magnetic Base, Handle	
<b>S/O</b>	(TOPHATMAGRS) Solar, Magnetic Base	
<b>453162</b>	(BGANCLT CLR) Incandescent Bulb	<b>\$45.09</b> B0-8504000

**RED LIGHT**

Order No.	Mfg. No. / Description	List Price
<b>453213</b>	(ANCHOR-RRDLX) (1) 6V Battery, Magnetic Base	<b>\$127.89</b> B0-0151100
<b>453174</b>	(BGANCLT RED) Incandescent Bulb	<b>\$45.09</b> B0-8504000

**Perko Fig. 1111 Special Purpose Flashing Yellow Light**



- Sheet metal, preprimed galvanized steel.
- Medium prefocus socket.
- Watertight terminal tube for 16/3-SJO cable.
- For use on vessels of any length.
- Height overall: 11-1/2", height lens: 6-3/4" .
- Visibility miles: 2, visibility arc: 225° .
- Flashes per minute: 50 - 70.
- Bulb: 120 volt only (Not included). Use Perko Fig. 342 Medium Prefocus Bulbs. Rough service bulbs are available.
- Designed to meet Federal Requirements for Flashing Yellow 180° - 225° light for barges, canal boats, etc., that are being pushed ahead or towed along side of a tug boat.

Order No.	Mfg. No. / Description	List Price
<b>524771</b>	(1111 ME1 GAL)	<b>\$631.89</b> A0-9813600

**SPARE ACCESSORIES**

Order No.	Mfg. No. / Description	List Price
<b>529909</b>	(0133) Spare Flasher Unit	<b>\$154.89</b> A0-9845100
<b>529404</b>	(0347 A00) Spare Medium Prefocus Socket	<b>\$67.69</b> A0-9676000
<b>529860</b>	(1105 000 BLK) Spare Access Cap with Chain	<b>\$36.59</b> A0-9563000
<b>529872</b>	(1119) Spare O-Ring for Cap	<b>\$6.09</b> A0-9060000

**REPLACEMENT BULBS - 120 volt, 60 watt**

Order No.	Mfg. No. / Description	List Price
<b>528286</b>	(0342 004 CLR) Clear	<b>\$51.99</b> D0-9514000
<b>528298</b>	(0342 RS4 CLR) Rough Service	<b>\$76.69</b> D0-5316000

**JDS Safety Lights Solar Barge Navigation Lights**



- Autonomy -12 nights without sun, Solar Panel Monocrystalline: 4v 0.5w.
- 125,000 hour life span.
- Meets IALA, and U.S.C.G. COLREGS.
- Material: Poly Carbonate, Battery: Aluminum Iron Phosphate Battery AA300MAH, Luminous Mode: Constant Type/Varying Type, Light Source: Super luminosity LED, LED Quality: 6 LED in the middle, 1 LED super bright, Waterproof Grade: IP>67, Visibility: 3 Kilometers.
- 115, 139 mm.
- Constant yellow.

Order No.	Mfg. No. / Description	List Price
<b>454819</b>	(381521)	<b>\$257.98</b> E0-9439100

**LIMITED QUANTITIES**



**McDermott L.E.D. Battery Powered Marker Lights**



- Durable, high visibility marker lights.
- 1-3 mile visibility.
- Runs on (1) 6V spring top battery.
- Automatically turns on at night.
- Different mount options and colors available.
- Alternate version available for hazardous locations (Class 1, Div 2).
- Steady or flashing in a wide variety of flash rates/patterns.
- Ideal for marking dredge operations.



Order No.	Mfg. No. / Description	List Price	
453473	(BZLED6V.04) White with Magnetic Base	\$124.79	BO-1321100
453471	(BZLED6L6V04) Red with Magnetic Base	\$124.79	BO-1321100
453504	(BZLED6L6V04) Blue without Magnetic Base	\$160.89	BO-0844100
453516	(BZLED6L6V04) Blue with Magnetic Base	\$184.59	BO-3166100
S/O	(BZDREDGE) Amber Flashing Bolt On Side		
S/O	(BZDREDGEMAG) Amber Flashing with Magnetic Base		
453592	(BZBRACKETBOL) Bolt for Bracket	\$3.09	BO-8720000

**CLASS 1, DIV 2 MARKER LIGHTS WITH MAGNETIC BASE**

Order No.	Mfg. No. / Description	List Price	
453530	(BZLED6L6V04) White	\$184.59	BO-3166100
453528	(BZLED6L6V04) Red	\$184.59	BO-3166100

**McDermott L.E.D. Certified Mast Light**



- For use on vessels 20 to 50 meters in length.
- 5 mile visibility.
- 6" x 6" mounting hole base.
- Compatible with all supervised alarm panels.
- Meets requirements of COLREGS 72 and UL1104.
- 2 year warranty.



Order No.	Mfg. No. / Description	List Price	
454699	(TB5MASTGL351) Incandescent Light	\$536.29	BO-6628400

**LIMITED QUANTITIES**

**McDermott L.E.D. Certified All Around Lights**



- For use on vessels 20 to 50 meters in length.
- Meets all applicable requirements of COLREGS 72, UL1104 and Subchapter M.
- 2 mile visibility.
- 4" x 4" mounting hole base.
- Compatible with all supervised alarm panels.
- 12, 24, 32 VDC and 120, 200 VAC available.
- 2 year warranty.



Order No.	Mfg. No. / Description	List Price	
454695	(TB278RED) 360° Red Lens	\$380.59	BO-3524300
454697	(TB278WHITE) 360° White Lens	\$380.59	BO-3524300
S/O	(TB278GREEN) 360° Green Lens		
S/O	(TB278AMBER) 360° Amber Lens		

**McDermott L.E.D. DriftLights**



- All around LED Marker light designed for fishnets and lobster traps.
- High impact polycarbonate.
- 1 mile visibility in multiple colors.
- Each unit has a steady and flashing mode.
- Waterproof up to 80 feet deep.
- In steady mode: 10 nights on (4) AA batteries.
- In flashing mode: 30 nights on (4) AA batteries.



Order No.	Mfg. No. / Description	List Price	
454649	(DRIFTLITEP-W) White Pole Mount	\$109.99	FO-9967000
S/O	(DRIFTLIGHTPA) Amber Pole Mount		
S/O	(DRIFTLIGHTPG) Green Pole Mount		
S/O	(DRIFTLIGHTPR) Red Pole Mount		
S/O	(DRIFTLIGHTPB) Blue Pole Mount		

**McDermott L.E.D. Certified Mast Light**



- For use on vessels 20 to 50 meters in length.
- 5 mile visibility.
- 4" x 4" mounting hole base.
- Built in screens.
- Compatible with all supervised alarm panels.
- Meets all applicable requirements of COLREGS 72, UL1104 and Subchapter M.
- 2 year warranty.



Order No.	Mfg. No. / Description	List Price	
454700	(TB5820MAST)	\$598.19	BO-7383500

**McDermott L.E.D. Certified Navigation Lights**



- For use on vessels from 20 to 50 meters in length.
- 2 mile visibility.
- 4" x 4" mounting hole base.
- Built in screens.
- Compatible with all supervised alarm panels.
- Meets all applicable requirements of COLREGS 72, UL1104 and Subchapter M.
- 2 year warranty.



Order No.	Mfg. No. / Description	List Price	
454669	(TB2DSTAR) Starboard Side	\$390.89	BO-0815300
454671	(TB2DPORT) Port Side	\$390.89	BO-0815300
S/O	(TB2DSTERNBLUE) Panama Steering		
454683	(TB2DSTERN) Stern	\$390.89	BO-0815300
454687	(TB2DTOW) Amber Tow	\$390.89	BO-0815300

- Electronics
- Trolling Motors
- Instruments
- Electrical
- Lighting
- Anchor & Dock
- Safety
- Steering, Controls
- Pumps
- Fuel System
- Seating & Pedestals
- Trailering
- Tops & Covers
- Perform.
- Propellers
- Engine & Care
- Cleaning & Care
- Paint & Paint Acc.
- Fun & Flotation
- Topside Acc.
- Cockpit & Deck
- Hardware, Fasteners
- Camouflage
- Misc.
- Comm.



McDermott L.E.D. Barge Navigation Lights



Multi-charger

- High impact, UV stabilized polycarbonate with built in screens and carrying handle.
- Certified to meet requirements for unmanned barges per UL1104.
- 3 nautical miles.
- Operates up to 40 nights on a full charge.
- Rechargeable 12V battery with an average life of 3-4 years.
- High strength magnets for mounting.
- Dimensions: 11-1/4" H x 14-1/2" L x 13" W.
- Kit includes: (1) Port, (1) Starboard, (1) Amber or Stern with (1) Multi-charger.
- Available with connection for plug-in peep steering light.

McDermott L.E.D. Solar Barge Navigation Lights



- High impact, UV stabilized polycarbonate with built in screens and carrying handle.
- Self-contained solar powered lights.
- Certified to meet requirements for unmanned barges per UL1104.
- 3 nautical miles.
- Operates up to 40 nights on a full charge.
- Rechargeable 12V battery with an average life of 3-4 years.
- Highly-efficient LED's rated for up to 20,000 hours.
- High strength magnets for mounting.
- Compatible with barge peep light.
- Dimensions: 11-1/4" H x 14-1/2" L x 13" W.
- Kit includes: (1) Port, (1) Starboard, (1) Amber or Stern.
- Available with connection for plug-in peep steering light.

Order No.	Mfg. No. / Description	List Price	
452487	(BGLEDCASEKIT) Amber Kit	\$1,985.39	A0-9358910
452471	(BGLEDCASEKIT) Stern Kit	\$1,985.39	A0-9358910
452514	(BGLEDCSEPORT) Port Side	\$529.49	A0-9492500
452526	(BGLEDCSESTAR) Starboard Side	\$529.49	A0-9492500
452538	(BGLEDCSESTRN) Stern	\$529.49	A0-9492500
452552	(BGLEDCASEFL) Amber Flashing	\$529.49	A0-9492500
454126	(BGLT-CHG-3) 3 Station Multi-charger	\$396.89	A0-9869300

Order No.	Mfg. No. / Description	List Price	
452615	(BGLEDCASESOL) Amber Kit	\$1,967.69	A0-9676910
452627	(BGLEDCASESOL) Port Side	\$626.69	A0-9662600
452639	(BGLEDCASESOL) Starboard Side	\$626.69	A0-9662600
452641	(BGLEDCASESOL) Stern	\$626.69	A0-9662600
452665	(BGLEDCASESOL) Amber Flashing	\$626.69	A0-9662600

McDermott Barge Replacement Parts

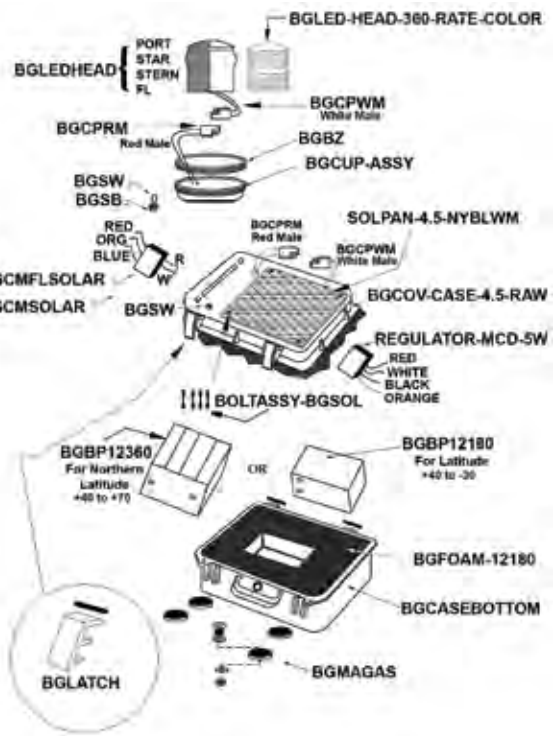

Order No.	Mfg. No. / Description	List Price	
453100	(BGLEDCASESOL) LED Port Head	\$211.29	A0-9211200
453112	(BGLEDCASESOL) LED Starboard Head	\$211.29	A0-9211200
453136	(BGLEDCASESOL) LED Amber Head	\$211.29	A0-9211200
S/O	(BGBZ) Head Locking Bezel		
S/O	(SOLPAN4.5) BGLEDCASE Solar Panel		
454542	(BGSW) Barge Toggle Switch	\$13.39	B0-5021000
S/O	(BGSB) Rubber Boot for Toggle Switch		
453767	(BGBP12180) Solas Barge Battery	\$91.29	B0-6128000
454619	(BGCPRM) Red LED Head Cable	\$9.59	B0-3680000
454631	(BGCPWM) White LED Head Cable	\$9.59	B0-3680000
454530	(BGPE) Metal Cased Photoeye	\$29.69	B0-2762000
453617	(BGCMPPE) Steady Barge Module	\$78.69	A0-9687000
453629	(BGCMPPE) Flash Barge Module	\$78.69	A0-9687000
S/O	(BGCMSOL) Steady Barge Solar Module		
S/O	(BGCMLSOL) Flash Barge Solar Module		
S/O	(REGMCD5W) Solar Barge Regulator		
S/O	(BGFOAM12180) Solar Battery Foam		
454607	(BGMAGAS) Barge Replacement Magnet	\$21.99	B0-9791000
453870	(BGLECONPLATE) Battery Contact Plate	\$28.69	B0-2852000
454314	(BGCH3-5-S) Charger Module for Charger Station	\$63.69	A0-9636000
453605	(BGCMPPEP) Control Module for Flashing	\$99.89	A0-9899000
454405	(BGINGREEN) Green Insert Filter for Starboard Lights	\$19.39	B0-5471000
454429	(BGCPCSTAR) Complete Lamp Assy. for Starboard Lights	\$80.49	B0-4427000
454458	(BGLENS) Base for Mounting Lens on Barge Light	\$25.09	B0-8522000
454491	(BGLBESTERN) Clear Lens w/Internal Screen for Stern Light	\$69.39	B0-5426000
454152	(BGBP1265) Rechargeable Battery	\$29.69	B0-2762000
454568	(BGCANNON101N) Cannon Plug with 10" Cable	\$23.89	B0-0512000
452499	(BGLEDCASEKIT) FLPEEP Barge Light	\$2,072.89	A0-9827020

McDermott Replacement Parts

Order No.	Mfg. No. / Description	List Price	
452791	(BGLEDCASEKIT) Stern Kit with No Batteries	\$978.59	A0-9587900
454455	(BGLENS) Clear Lens	\$45.79	B0-1214000
452650	(BGLEDCASE-ST) Starboard Side Fog Feature	\$573.69	A0-9637500

Order No.	Mfg. No. / Description	List Price	
452655	(BGLEDCASE-PO) Port Side Fog Feature	\$573.69	A0-9637500
452660	(BGLEDCASE-FL) Amber Flashing Fog Feature	\$661.19	A0-9116600

SPECIAL HANDLING MAY APPLY



- Electronics
- Trolling Motors
- Instruments
- Electrical
- Lighting
- Anchor & Dock
- Safety
- Steering, Controls
- Pumps
- Fuel System
- Seating & Pedestals
- Trailering
- Tops & Covers
- Perform.
- Propellers
- Engine & Care
- Cleaning & Care
- Paint & Paint Acc.
- Fun & Flotation
- Topside Acc.
- Cockpit & Deck
- Hardware, Fasteners
- Camouflage
- Misc.
- Comm.

**McDermott L.E.D. Barge Navigation Lights**



452754

452730

452742

- High impact, UV stabilized polycarbonate with built in screens.
- Certified to meet requirements for unmanned barges per UL1104.
- 3 nautical miles.
- Runs on rechargeable or alkaline 6V battery.
- Built-in photosensor allows these lights to automatically turn themselves on at night and off during the day.
- Runs for up to 40 nights on two 6V alkaline batteries.
- Dimensions: 11-1/2" H x 7" L x 4-1/4" W.
- Kit includes: (1) Port, (1) Starboard, (1) Amber and chargers.
- Connection for plug-in peep steering light.



452778

Order No.	Mfg. No. / Description	List Price	
452716	(BGLED888KIT) Amber Kit with Peep Ext	\$1,799.29	BO-6391610
452730	(BGLED888PORT) Port Side	\$422.79	BO-1508300
452742	(BGLED888STAR) Starboard Side	\$422.79	BO-1508300
452754	(BGLED888STRN) Stern	\$422.79	BO-1508300
452778	(BGLED888FL) Amber Flashing	\$502.59	BO-3325400
453782	(BP650L) 6-volt Rechargeable Battery	\$28.49	BO-4652000
453845	(BGACHG121888) Automatic 6-volt Battery Charger	\$131.69	AO-9613100

**BARGE NAVIGATION LIGHTS WITHOUT BATTERIES**

Order No.	Mfg. No. / Description	List Price	
452805	(BGLED888KIT) Amber Kit	\$1,196.89	BO-0277010
452829	(BGLED888PORT) Port Side	\$372.39	BO-5153300
452831	(BGLED888STAR) Starboard Side	\$372.39	BO-5153300
452843	(BGLED888STRN) Stern	\$372.39	BO-5153300
452867	(BGLED888FL) Amber Flashing	\$372.39	BO-5153300

**HAZARDOUS LOCATIONS NAVIGATION LIGHTS**

- Class 1 Division 2, for use in Hazardous Locations.

Order No.	Mfg. No. / Description	List Price	
452893	(BG888KITFL) Amber Kit - Class 1, Div 2	\$1,298.79	BO-1986110
452906	(BGLED888PORT) Port Side - Class 1, Div 2	\$432.89	BO-0698300
452918	(BGLED888STAR) Starboard Side - Class 1, Div 2	\$432.89	BO-0698300
452956	(BGLED888FL) Amber Flashing - Class 1, Div 2	\$432.89	BO-0698300

**McDermott Wired Barge Platform Lights**



BGPLATPORT

BGPLATSTERN

BGPLATSTAR

BGPLATFL

- 3 mile visibility.
- High impact polycarbonate.
- Built in screens.
- 12, 24, 32 VDC and 120, 200 VAC available.
- Available with 3', 25' and 50' of cable.
- Optional photoeye and local switch.
- Meets all applicable requirements of UL1104 for unmanned barges.

Order No.	Mfg. No. / Description		
S/O	(BGPLATPORT) Port Side		
S/O	(BGPLATSTAR) Starboard Side		
S/O	(BGPLATSTERN) Stern		
S/O	(BGPLATFL) Amber Flashing		

**McDermott Tophat Series Solar Marker Lights**



TOPHATMAGCL

TOPHATBUNYL

TOPHATPLATRD

- Rugged and waterproof LED solar light for the marine industry.
- High impact polycarbonate.
- 1-3 mile visibility.
- Operates up to 10 nights without sun.
- Available colors: Clear, Red, Green, Amber and Blue.
- Flash rates: Steady, 10, 15, 24, 30, 60 FPM or any IALA Code.
- Dimensions: 5" high, 7" base.
- TOPHATX Model for areas with low daylight hours.



TOPHATFLATGR

**TOPHAT SERIES MOUNTING OPTIONS**

Order No.	Mfg. No. / Description	List Price	
453262	(TOPHATMAGRS) Magnetic Mount Clear	\$256.79	BO-1113200

- MAG: 3" dia. 80 lb pull magnet.
- FLATP: 7-3/4" dia. flat plate with 3 mount holes.
- PIPE: 3" dia. flange with 1" NPT hub.
- PLAT: 6" dia. x 6-3/4" H platform with 3 mount holes.
- BUNY:

**McDermott Tophat Series L.E.D. Solar Barge Lights**



- High impact, UV stabilized polycarbonate.
- Meets UL 1104 applicable sections for a 2NM Barge Light.
- 2 nautical miles.
- Built in screens.
- Rechargeable 12V battery with an average life of 4 years.
- Built-in photosensor allows these lights to automatically turn themselves on at night and off during the day.
- Runs for up to 10 nights on a full charge.
- Solar-powered navigation lights for barges less than 50 meters.
- High strength magnets for mounting.
- Dimensions: 5-1/8" H x 7" W.



453263

453264



453265

Order No.	Mfg. No. / Description	List Price	
453263	(TOPHAT-PORT) Port Side	\$377.29	BO-6593300
453264	(TOPHAT-STAR) Starboard Side	\$377.29	BO-6593300
453265	(TOPHAT-FL) Amber Flashing	\$377.29	BO-6593300
S/O	(TOPHAT-STRN) Stern		

**McDermott Barge L.E.D. Peep Steering Lights**



453314

453306

454645

Order No.	Mfg. No. / Description	List Price	
453314	(BARGEPEEP) 25' Cable, Cannon Plug	\$132.99	BO-9691100
453306	(PEEPSOLAR) Solar Peep Light	\$310.39	BO-5397200
454645	(DRIFTPEEP) Peep Driftlight with Velcro	\$95.89	BO-0368000
453302	(PEELIGHT) Incandescent Bulb	\$67.39	AO-9376000

- Electronics
- Trolling Motors
- Instruments
- Lighting
- Anchor & Dock
- Safety
- Steering, Controls
- Pumps
- Fuel System
- Seating & Pedestals
- Trailer
- Tops & Covers
- Perform.
- Propellers
- Engine & Care
- Cleaning & Care
- Paint & Paint Acc.
- Fun & Flotation
- Topside Acc.
- Cockpit & Deck
- Hardware, Fasteners
- Camouflage
- Misc.
- Comm.

**Phoenix Vaporproof Incandescent Fixture**



- Non-metallic, thermoplastic construction.
- Silicone gaskets provide vaportight seal.
- External screws and inserts made out of corrosion resistant brass.
- Clear glass globe.
- Housing and guard standard gray finish.
- Wall mount.
- UL 1598, 1598A, 844 Listed.
- USCG Accepted.
- Accepts incandescent lamps up to 150 watts.
- Note: Bulb not included.
- 120 volt.

Order No.	Mfg. No. / Description	List Price	
<b>603808</b>	(VPWINC120GHC)	<b>\$259.29</b>	HO-7555100

**Pauluhn ProGuard Lighting Incandescent Fixture**



- Cast copper free aluminum housing and guard.
- Lamp holder: Medium base, high temperature PBT.
- Nickel plated copper screw shell.
- Compact fluorescent polycarbonate.
- Clear glass 6" globe.
- Stainless steel hardware.
- Length 11".
- A-19, 100 watt lamp.
- UL Marine and USCG Approved.
- Note: Bulb not included.

Order No.	Mfg. No. / Description	List Price	
<b>686381</b>	(707A)	<b>\$261.09</b>	CO-3912200

**Medium Screw Replacement Bakelite Socket**



- Includes (4) fastener holes.
- Fits current Pauluhn lights.

Order No.	Mfg. No. / Description	List Price	
<b>686367</b>	(INX4000)	<b>\$63.69</b>	CO-4145000

**6" Plastic Globes for Deck Light**



- Smooth, round top cylinder.
- Diameter 5.1".

Order No.	Mfg. No. / Description	List Price	
<b>686277</b>	(CP60) Clear	<b>\$35.99</b>	CO-9503000
<b>686281</b>	(CP65) Amber	<b>\$35.99</b>	CO-9503000

**Hubbell Wall Mounting Bracket**



- Gray non-metallic.
- Vapor tight.
- For use with NVX15GHGA incandescent fixture.
- Dimensions: 6.7" L x 5.3" W x 4.8" H.

Order No.	Mfg. No. / Description	List Price	
<b>398203</b>	(NVBA)	<b>\$75.59</b>	GO-5605000

**LIMITED QUANTITIES**

**Replacement 6" Guards**



- Diameter 6".

Order No.	Mfg. No. / Description	List Price	
<b>686230</b>	(INX1036A) Aluminum	<b>\$114.79</b>	CO-7579000
<b>686242</b>	(INX1036B) Brass	<b>Special Order</b>	

**6" Glass Globe**



- Glass globe.
- Diameter 6".

Order No.	Mfg. No. / Description	List Price	
<b>686266</b>	(COAC60) Clear	<b>\$21.79</b>	CO-2581000

**Mobern Lighting Series VT Fluorescent Fixtures - Vaportite**



- Dust and moisture resistant.
- Virtually unbreakable fiberglass housing provides superior corrosion resistance.
- No drilling necessary with external brass studs.
- White molded end plugs snap and lock to maintain tight seal of unused end holes.
- High impact acrylic diffuser held with positive cam latches.
- Continuous poured in place gasket.
- 120 volt. 2 lamp. Note: Lamps not included.
- No joints to open.
- UL listed for damp location.

Order No.	Mfg. No. / Description	List Price	
<b>603743</b>	(VT-217MV) Length 2'	<b>\$162.98</b>	F0-9041100
<b>603755</b>	(VT-232MV) Length 4'	<b>\$166.98</b>	F0-9861100
<b>603767</b>	(H92) Stainless Steel Clips	<b>\$5.98</b>	E0-9440000
<b>603779</b>	(L293) Replacement Lens for 2' Fixture	<b>\$45.98</b>	E0-9443000
<b>603785</b>	(L196) Replacement Lens for 4' Fixture	<b>\$57.98</b>	E0-9434000

**LIMITED QUANTITIES**

**Britmar Fluorescent Fixtures**



- Dustproof light fixture with resistant against water jets.
- Grey polycarbonate housing, with transparent polycarbonate cover, chemical resistant.
- IP66.
- Direct fastening on ceiling mounted brackets or suspension with self-locking suspenders or steel wire.
- M20 cable gland for 6-13 mm cables.
- 120 - 277V AC.

Order No.	Mfg. No. / Description	List Price	
<b>603805</b>	(BREXTRALED2) Length 2'	<b>\$187.99</b>	D0-9305100
<b>603820</b>	(BREXTRALED4) Length 4'	<b>\$241.99</b>	D0-9539100

**NEW PRODUCT**

**Mobern Lighting Replacement Lens for Series VW Fluorescent Fixture**



Order No.	Mfg. No. / Description	List Price	
<b>603844</b>	(L622) Replacement Lens for 2' Fixture	<b>\$25.09</b>	H0-5051000
<b>603859</b>	(L623) Replacement Lens for 4' Fixture	<b>\$38.89</b>	H0-3332000

**LIMITED QUANTITIES**

**SPECIAL HANDLING MAY APPLY**



Electronics

Trolling Motors

Instruments

Electrical

Lighting

Anchor & Dock

Safety

Steering, Controls

Pumps

Fuel System

Seating & Pedestals

Trailing

Tops & Covers

Perform.

Propellers

Engine & Care

Cleaning & Care

Paint & Paint Acc.

Fun & Flotation

Topside Acc.

Cockpit & Deck

Hardware, Fasteners

Camouflage

Misc.

Comm.

**Marpac L.E.D. Dome Lights**



- Polished stainless steel housing and trim ring with glass lens.
- Uses #4 fasteners.
- Prewired with on/off switch.
- 12 volt, 18 LED's.



Order No.	Description	List Price
7-6678	Lens Diameter 4" Outside Diameter: 5-1/2"	\$48.39 G0-2423000
7-6679	Lens Diameter 5" Outside Diameter: 6"	\$48.39 G0-2423000

**Marpac Dome Light**



- Polished stainless steel housing and trim ring with solid glass lens.
- Prewired with an on/off switch.
- Lens diameter 5".
- Outside diameter 6".
- 12 volt, 15 watt bulbs included.



Order No.	Description	List Price
7-0601	Dome Light	\$37.29

**LIMITED QUANTITIES**

**Perko Fig. 1263 Exterior Surface Mount Dome Light**



- Three position toggle switch.
- Ivory Perko - Kote zinc alloy with red and white bulbs.
- Lens OD 4", base OD 5", depth 1-7/8".
- Uses #10 R.H. fasteners.
- Complete with 12 volt, 11 watt bulb.



Order No.	Mfg. No. / Description	List Price
544468	(1263 DP1 WHT)	\$91.89 F0-2346000

**Lumitec Aurora - L.E.D. Surface Mount Dome Light**



- White finish.
- Clean look, an intuitive and reliable built-in switch.
- Completely water sealed and IP67 compliant.
- Diameter 4", depth .73".
- White Dimming, Blue Dimming
- 345mA @ 12V DC, 210mA @ 24V DC.



Order No.	Mfg. No. / Description	List Price
378905	(101075)	\$132.99 Z0-9229000

**MAP PRICE**

**Perko Fig. 1253 Exterior Surface Mount Dome Lights**



- Ivory Perko - Kote zinc alloy.
- White translucent polymer lens.
- Double contact bayonet socket.
- Black vinyl mounting gasket.
- Push switch with water resistant boot.
- Diameter 6". Depth overall 2".
- Complete with 12 volt bulb.



Order No.	Mfg. No. / Description	List Price
533813	(1253 DP2 WHT)	\$74.39 F0-7025000

**T-H Marine L.E.D. Surface Mount Dome Lights**



- Surface mount.
- UV stable white housing resists color fading.
- Hidden fasteners.
- On/off rocker switch on bezel.
- Super Flux (P4) type LEDs, super bright with long life span of up to 100,000 hours.
- Diameter 4".



Order No.	Mfg. No. / Description	List Price
642545	(LED-51829-DP) 15 Cool White LEDs	\$55.89 F0-2193000
642548	(LED-51830-DP) 6 Red/9 White LEDs	\$60.29 F0-0224000

**T-H Marine L.E.D. Rail Light**



- Surface mount.
- Light rotates to direct light where you want it.
- Powder coated aluminum extrusion rail with molded mounting ends.
- 12 Cool White LEDs.
- Length 6".



Order No.	Mfg. No. / Description	List Price
642560	(LED-51857-DP)	\$40.89 F0-2682000

**Marpac L.E.D. Rail Light**



- 12" LED rail light.
- On/Off switch.
- Swivel mount allows for mounting in many locations.



Order No.	Description	List Price
1-51117	Rail Light	\$32.29 F0-0622000

**Lumitec Anywhere - L.E.D. Utility Lights**



- Brush finish.
- Quality aluminum housing with Type II anodizing for an appealing satin look.
- Surface mount.
- Completely water sealed and IP67 compliant.
- Diameter 1.73", depth .45".
- 360mA @ 12V DC, 200mA @ 24V DC.



Order No.	Mfg. No. / Description	List Price
378754	(101033) White Non-Dimming	\$54.49 Z0-9873000
378756	(101034) Blue Non-Dimming	\$54.99 Z0-9283000

**MAP PRICE**

- Electronics
- Trolling Motors
- Instruments
- Electrical
- Lighting
- Anchor & Dock
- Safety
- Steering, Controls
- Pumps
- Fuel System
- Seating & Pedestals
- Trailer
- Tops & Covers
- Perform.
- Propellers
- Engine & Care
- Cleaning & Care
- Paint & Paint Acc.
- Fun & Flotation
- Topside Acc.
- Cockpit & Deck
- Hardware, Fasteners
- Camouflage
- Misc.
- Comm.

**Lumitec Poco 3 Digital Lighting Control Module**



**MAP PRICE**  
**NEW PRODUCT**

Order No. **378766** Mfg. No. / Description (101699) List Price **\$362.99** Z0-9565200

- Delivers powerful, low-cost, on-board lighting control through a compatible MFD or connected smart device and a simple, easy to install control module.
- When installed with Lumitec's PLL-enabled lights, even more functionality is unleashed – precise color selection and intensity, custom lighting scene creation and multiple 'virtual circuits' on a single channel, allowing aftermarket installers to add lights and improve on-board lighting designs without adding any additional home-(wire) runs.
- Dimensions: 3-1/2" H x 5-1/2" W x 1-1/4" D.
- White.
- 10V DC - 30V DC.

**Marpac L.E.D. Utility Strip Lights**

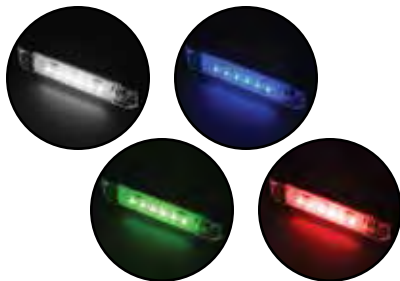

- LED strip light with clear lens.
- Use above or below the waterline.
- Low amp draw: .36 amps.
- No burning filament.
- Shock resistant.
- Pigtail wire.
- Includes stainless steel mounting hardware.
- 12 volt.

Order No.	Description	List Price	
<b>7-33600</b>	White Length 4"	<b>\$5.79</b>	FO-5040000
<b>7-33601</b>	Blue Length 4"	<b>\$10.79</b>	FO-5570000
<b>7-33602</b>	Green Length 4"	<b>\$10.79</b>	FO-5570000
<b>7-33603</b>	Red Length 4"	<b>\$10.79</b>	FO-5570000
<b>1-33605</b>	White Length 6"	<b>\$13.39</b>	HO-3080000
<b>1-33607</b>	Green Length 6"	<b>\$18.49</b>	HO-9011000
<b>1-33608</b>	Red Length 6"	<b>\$13.39</b>	HO-3080000
<b>7-33610</b>	White Length 8"	<b>\$11.59</b>	FO-1180000
<b>7-33611</b>	Blue Length 8"	<b>\$13.59</b>	FO-1590000
<b>7-33612</b>	Green Length 8"	<b>\$15.89</b>	FO-2111000
<b>7-33613</b>	Red Length 8"	<b>\$12.89</b>	FO-2090000

**Boater Sports L.E.D. Accent Lights**



- From early morning fishing trips to evening cruises a little accent light goes a long way.
- Low profile and extremely energy efficient design make for a very versatile light.
- Fully sealed and rugged design means this light is perfectly at home in heavy traffic areas around the deck of your boat.
- Pre-wired pig tail wire harness for ease of installation.

Order No.	Mfg. No. / Description	List Price	
<b>1-51945</b>	(51945) Blue	<b>\$6.29</b>	FO-0440000
<b>1-51989</b>	(51989) White	<b>\$6.29</b>	FO-0440000

**Mossy Oak® Camouflage L.E.D. Mini Utility Light**



- High output accent lighting in a small package.
- The Mossy Oak Marine LED Accent Light gives vibrant high output illumination with minimal energy draw.
- Fully enclosed water proof construction.
- Includes mounting hardware.

Order No.	Mfg. No. / Description	List Price	
<b>1-34084</b>	(34084) White	<b>\$9.49</b>	E0-2170000

**LIMITED QUANTITIES**

**Marpac L.E.D. RGB Utility Strip Lights**



- RGB - combines red, green, blue and white LEDs to form a wide variety of colors.
- LED strip light with clear lens.
- Use above or below the waterline.
- Low amp draw: 36 mA. No burning filament.
- Shock resistant.
- Pigtail wire.
- Includes stainless steel mounting hardware.
- 12 volt.

Order No.	Description	List Price	
<b>7-33615</b>	Length 4"	<b>\$16.39</b>	FO-7411000
<b>7-33617</b>	Length 8"	<b>\$25.49</b>	FO-4871000

**CONTROLLER**

- Controls RGB light color and intensity.
- Hue slider for easy color selection.
- 4 preset pattern modes: Strobe, fast strobe, fade, fast fade.
- Quick buttons for red, green, blue and white.
- Illuminated power button.
- Smooth surface with a sleek design.



Order No.	Description	List Price	
<b>7-33655</b>	Controller	<b>\$74.19</b>	FO-3915000
<b>7-32656</b>	5 Conductor RGB Wire	<b>\$65.19</b>	HO-1193000

**T-H Marine L.E.D. Oblong Courtesy Lights**



- Attractive stainless bezel courtesy lights can be used virtually anywhere.
- Surface mount. Hidden fasteners.
- 3 bright LEDs provide excellent brilliance.
- Dimensions: 3" L x 1-1/4" W.

Order No.	Mfg. No. / Description	List Price	
<b>642521</b>	(LED-51823-DP) Blue	<b>\$30.19</b>	FO-3112000
<b>642524</b>	(LED-51824-DP) Red	<b>\$30.19</b>	FO-3112000
<b>642527</b>	(LED-51825-DP) White	<b>\$30.19</b>	FO-3112000

**T-H Marine L.E.D. Oval Courtesy Light Kit**



- Features a built-in push lens switch for easy On/Off control.
- Can be hole mounted or flush mounted.
- Designed for a standard size of 3-1/4" x 2-1/8".
- Flanged overall 5" x 3-1/8".
- Kit includes the light and mounting ring.

Order No.	Mfg. No. / Description	List Price	
<b>3420528</b>	(LED-OCL-2K-DP) White	<b>\$51.09</b>	G1-1233000

**T-H Marine L.E.D. Companion Way Lights**



- Light pathways, steps and utility boxes economically.
- Opaque PC lens produces warm glow.
- Easy surface mount.
- Dimensions: 2.6" L x 1.3" W.
- Fasteners included.

Order No.	Mfg. No. / Description	List Price	
<b>642506</b>	(LED-51816-DP) Black Bezel 2 White LEDs	<b>\$18.99</b>	F0-9231000
<b>642509</b>	(LED-51819-DP) White Bezel 2 White LEDs	<b>\$18.99</b>	F0-9231000
<b>642515</b>	(LED-51822-DP) Chrome Bezel 2 White LEDs	<b>\$21.59</b>	F0-1151000
<b>642518</b>	(LED-51820-DP) Chrome Bezel 2 Blue LEDs	<b>\$21.59</b>	F0-1151000

**Perko Fig. 140 Surface Mount Utility Light**



- White molded polymer.
- Diffused light cover.
- Length overall 1-7/8", width 9/16".
- Uses #6 fasteners.
- Includes 12 volt, 1 watt bulb.

Order No.	Mfg. No. / Description	List Price	
<b>534695</b>	(0140 DPO NYN)	<b>\$11.49</b>	G0-0770000

**LIMITED QUANTITIES**

**Rigid A-Series L.E.D. Accessory Light**



- High grade aluminum alloy.
- Durable UV resistant powder coat.
- Impact resistant polycarbonate lens.
- 50,000 plus hour lifespan.
- Over/under voltage protection.
- RFI/EMI and reverse polarity protection.
- Dimensions: 2" x 3".
- Mount adaptors included.
- 4 watts, 0.29 amps.
- 10-28V DC.

Order No.	Mfg. No. / Description	List Price	
<b>202216</b>	(480023) Black Housing	<b>\$40.00</b>	E0-0003000

**NEW PRODUCT**

**T-H Marine Mini L.E.D. Dual Mount Courtesy Light**



- They mount vertically or horizontally for low profile placement on steps, companionways, under cabinets, compartments and more.
- Low heat, low amp draw, non-corrosive, shock and water resistant.
- Dimensions: 2-1/8" L x 5/8" H x 1/2" W.
- Stainless steel fasteners included.
- 3 White LEDs.

Order No.	Mfg. No. / Description	List Price	
<b>642590</b>	(LED-51880-DP)	<b>\$17.09</b>	F0-6911000

**T-H Marine L.E.D. Courtesy Companion Way Lights**



- Great for compartments, rod lockers, gear bins, etc.
- Lights a pathway or storage area.
- Frosted PC lens with 3 White LEDs.
- Circuit board completely sealed in epoxy to resist water, corrosion and vibration.
- Dimensions: 2-1/4" x 2-1/4".
- Hole diameter: 1-3/4".
- 3 White LEDs.

Order No.	Mfg. No. / Description	List Price	
<b>642581</b>	(LED-51876-DP) White Bezel Exposed Fasteners	<b>\$16.59</b>	F0-1611000
<b>639840</b>	(LED-51894-DP) White Bezel Hidden Fasteners	<b>\$18.79</b>	F0-5131000
<b>642587</b>	(LED-51891-DP) Black Bezel Hidden Fasteners	<b>\$18.79</b>	F0-5131000

**Perko Fig. 1044 Light with Snap on Front Cover**



- White molded polymer.
- Snap-on front cover conceals mounting screws.
- Diffusion lens.
- Flush mounting.
- Installs in a 1-3/4" diameter hole.
- Length 2-1/4", width 2-1/4", height 1". Uses #6 fasteners.
- Includes 12 volt, 3 watt bulb. Supplied with 7" pig tail wire lead

Order No.	Mfg. No. / Description	List Price	
<b>531625</b>	(1044 DP2 WHT) White Connection: 7" Pig Tail Wire	<b>\$11.69</b>	G0-3870000

**LIMITED QUANTITIES**

**Lumitec Andros L.E.D. Courtesy Lights**



- White finish.
- Compact, attractive, remarkably bright.
- Completely sealed (IP67 compliant).
- Perfect for interior or exterior installations, ideal for helm stations, flybridges and hard tops.
- Height 1", width 1", depth 1/2".
- 45mA @ 12V DC.

Order No.	Mfg. No. / Description	List Price	
<b>378919</b>	(101046) White Non-Dimming	<b>\$29.49</b>	Z0-9502000
<b>378922</b>	(101047) Blue Non-Dimming	<b>\$29.49</b>	Z0-9702000

**MAP PRICE**

- Electronics
- Trolling Motors
- Instruments
- Electrical
- Lighting**
- Anchor & Dock
- Safety
- Steering, Controls
- Pumps
- Fuel System
- Seating & Pedestals
- Trailering
- Tops & Covers
- Perform.
- Propellers
- Engine & Care
- Cleaning & Care
- Paint & Paint Acc.
- Fun & Flotation
- Topside Acc.
- Cockpit & Deck
- Hardware, Fasteners
- Camouflage
- Misc.
- Comm.

**Marpac L.E.D. Recessed Mount Light**



- White LEDs.
- Round, recessed mount interior light.
- Diameter 3".
- Pigtail wire connection.
- Includes: 3 Bezels (black, white and chrome plated).

Order No.	Description	List Price	
<b>7-51654</b>	L.E.D. Recessed Mount Light	<b>\$17.99</b>	FO-9521000

**T-H Marine L.E.D. Recessed Puck Lights**



- Low profile LED lights creates a smooth look.
- 6 LEDs.
- Recessed mounting.
- Diameter 3". Requires 2" hole diameter.
- Includes three bezels (chrome, black and white) to allow for interchangeable options.

Order No.	Mfg. No. / Description	List Price	
<b>642554</b>	(LED-51848-DP) Red	<b>\$47.59</b>	FO-1333000
<b>642557</b>	(LED-51849-DP) Blue	<b>\$47.59</b>	FO-1333000

**T-H Marine L.E.D. Stainless Steel Puck Lights**



- Polished 304 stainless steel housing.
- Ideal for use in boats and RV's as a ceiling light, courtesy light, or task light.
- Clear polycarbonate engineered lens optics provide uniform and wide angle illumination.
- Surface mount on any flat surface.
- Dimmable.
- Hidden fasteners.

Order No.	Mfg. No. / Description	Diameter	List Price	
<b>642530</b>	(LED-51827-DP) 4 Warm White LEDs	Diameter 3"	<b>\$62.19</b>	FO-3534000
<b>642535</b>	(LED-51828-DP) 4 Blue LEDs	Diameter 3"	<b>\$60.29</b>	FO-0224000
<b>642539</b>	(LED-51831-DP) 6 Warm White LEDs	Diameter 4"	<b>\$86.69</b>	FO-8606000
<b>642542</b>	(LED-51832-DP) 6 Blue LEDs	Diameter 4"	<b>\$90.59</b>	FO-1436000

**Lumitec Shadow - Flush Mount L.E.D. Down Light**



- Polished stainless steel finish.
- Completely sealed (IP67 compliant).
- Compatible with 3rd party controllers including dimmers, flashers and scene controllers.
- Diameter 3-1/2", depth 1.10".
- 430mA @ 12V DC. 260mA @ 24V DC.
- White Dimming, Red and Blue Non-Dimming.

Order No.	Mfg. No. / Description	List Price	
<b>378875</b>	(114118)	<b>\$125.99</b>	Z0-9288000

**MAP PRICE**

**Lumitec Mirage - Flush Mount L.E.D. Down Lights**



378884



378887



- Completely sealed and IP67 rated, Mirage LED down lights are perfectly suited for a variety of indoor or outdoor overhead lighting needs.
- Diameter 3-1/4", depth 1".
- 360mA @ 12V DC. 180mA @ 24V DC.

**MAP PRICE**

**POLISHED STAINLESS STEEL FINISH**

Order No.	Mfg. No. / Description	List Price	
<b>378884</b>	(113119) High CRI Warm White Dimming	<b>\$119.99</b>	Z0-9248000

**WHITE FINISH**

Order No.	Mfg. No. / Description	List Price	
<b>378887</b>	(113128) White Dimming, Red and Blue Non-Dimming	<b>\$119.99</b>	Z0-9248000

**Boater Sports RGBW L.E.D. Light Display with Controller**



- Controller operated function to display RGBW LED Lights.
- Allows for a complete demonstration of the most popular RGBW LED Lights.
- Show the full color ranges, fade and strobe features and the variable intensities available with controller operated RGBW LED lights.

Order No.	Mfg. No. / Description	List Price	
<b>1-38869</b>	(38869)	<b>\$397.89</b>	E0-2489200

**LIMITED QUANTITIES**

**Boater Sports L.E.D. Light Display**



- Push button function to show the operation of LED Lights.
- Displays the most popular single color and multi color LED lights that do not require a controller.
- Demonstrate the intensity and the impact of adding LED Lighting from one simple display.

Order No.	Mfg. No. / Description	List Price	
<b>1-39868</b>	(38868)	<b>\$403.19</b>	E0-9320300

**LIMITED QUANTITIES**

- Electronics
- Trolling Motors
- Instruments
- Electrical
- Lighting
- Anchor & Dock
- Safety
- Steering, Controls
- Pumps
- Fuel System
- Seating & Pedestals
- Trailing
- Tops & Covers
- Perform.
- Propellers
- Engine & Care
- Cleaning & Care
- Paint & Paint Acc.
- Fun & Flotation
- Topside Acc.
- Cockpit & Deck
- Hardware, Fasteners
- Camouflage
- Misc.
- Comm.

**Lumitec Orbit - Flush Mount L.E.D. Down Lights**



378893



378899



- With a shallow-depth profile (less than 1/2" mounting depth) and a secure composite mounting system, these lights are ideal for a variety of cabin lighting, T-top lighting and mezzanine uses.
- Intelligent circuitry enables advanced features like dimming and multi-color control without external control modules, specialized switches, or additional wire runs.
- Completely water sealed and IP67 compliant.
- Diameter 2", depth 3/4".
- 290mA @ 12V DC. 160mA @ 24V DC.
- White, Red, Blue and Purple Non-Dimming

Order No.	Mfg. No. / Description	List Price	MAP PRICE
378893	(112500) Brushed Finish	\$122.99	Z0-9368000
378899	(112520) White Finish	\$119.99	Z0-9248000

**Boater Sports Portable L.E.D. Light Kits with Mounting Track**



- Great for tool boxes and truck beds, coolers and storage, cars, motorcycles, all-terrain vehicles, kayaks and boats.
- Easy installation.
- No wiring required.
- Water resistant construction.
- Flex track with finished ends.
- Length 18".
- Includes (3) AA Batteries.

Order No.	Description	List Price	LIMITED QUANTITIES
1-34088	White	\$23.89	H0-3341000
1-34089	Green	\$23.89	H0-3341000

**Lumitec Exuma - L.E.D. Courtesy Light**



378770



378764



- Small, attractive and discreet, Exuma lights offer more light output than many 'full size' overhead lights.
- Clean, almost flush and easy to install.
- Fully water sealed and IP67 compliant, Exuma is surface mountable and fits almost anywhere, perfect for interior or exterior installations.
- Diameter .98", depth .44".
- 45mA @ 12V DC.

Order No.	Mfg. No. / Description	List Price	MAP PRICE
378764	(101050) Blue Housing: Polished Stainless Steel	\$28.99	Z0-9302000
378770	(101052) White Housing: White	\$28.99	Z0-9302000

**Attwood L.E.D. Interior and Exterior Light**



- Stainless steel bezel with White LED color.
- Fully potted electronics and stainless steel housing allow for interior and exterior mounting - even underwater!
- Rated for 50,000+ hours of life.
- Diameter 1-1/2".
- 12 volt.

Order No.	Mfg. No. / Description	List Price	MAP PRICE
235576	(6342SS7)	\$34.59	F0-1242000

**Marpac L.E.D. Contour Flex Light**



- The LED contour flex light is completely waterproof, self-adhesive and contours to any kind of tubing or curved surface for your Bimini top, T-top or handrails.
- Great for use at the helm, in hatches, and fits neatly under steps and countertops.
- The 12 volt LED strip can be operated in a white task mode or a blue accent mode.
- Totally silicone encapsulated, the LED strip has permanent 3M VHB adhesive and insures a long life.
- Just clean the surface and stick it, it's that easy to install.
- Length 14", width 1".
- Red/White.

Order No.	Description	List Price	LIMITED QUANTITIES
7-6613	L.E.D. Contour Flex Light	\$24.49	G0-1461000

- Electronics
- Trolling Motors
- Instruments
- Electrical
- Lighting
- Anchor & Dock
- Safety
- Steering, Controls
- Pumps
- Fuel System
- Seating & Pedestals
- Trailering
- Tops & Covers
- Perform.
- Propellers
- Engine & Care
- Cleaning & Care
- Paint & Paint Acc.
- Fun & Flotation
- Topside Acc.
- Cockpit & Deck
- Hardware, Fasteners
- Camouflage
- Misc.
- Comm.



Electronics

Trolling Motors

Instruments

Electrical

Lighting

Anchor & Dock

Safety

Steering, Controls

Pumps

Fuel System

Seating & Pedestals

Trailing

Tops & Covers

Perform.

Propellers

Engine & Care

Cleaning & Care

Paint & Paint Acc.

Fun & Flotation

Topside Acc.

Cockpit & Deck

Hardware, Fasteners

Camouflage

Misc.

Comm.

T-H Marine Blue Water L.E.D. Lighting Products

T-H Marine Blue Water L.E.D. High Output UV Blacklight Kit



- The Blue Water LED High Output UV Blacklight Kit is a powerful UV light source that provides enough light for the longest casts, and will also illuminate objects in the water like stumps or standing timber.
- What's more, the light is projected in a wide beam angle so there are no "dead spots."
- Includes the Blue Water LED lifetime limited warranty.
- Note: For boats larger than 18 feet you should consider two kits for better coverage.
- Kit includes: (2) 60 LED/40" Blue Water LED High Output UV Light Strips with 3M Industrial Waterproof Adhesive Backing., (1) Mini-rocker on/off power switch, 10' of 18/2 gauge installation wire and T-tap & male connectors.

Order No.	Mfg. No. / Description	List Price	
587414	(LEDBW101UVDP)	\$260.29	FO-0228100

T-H Marine Blue Water L.E.D. Night Blaster Deck Lighting System



- Allows you to clearly see your deck for early morning or nighttime fishing while also providing a unique "Wow" factor to your boat.
- Engineered with Blue Water LED's proprietary rugged design, use this easy to install deck lighting system to light up your front deck in a big way or split it up between front and rear decks.
- Includes: (2) 30 LED/20" Blue Water LED Light Strips with 3M Industrial Waterproof Adhesive Backing for front deck, (2) 15 LED/10" Blue Water LED Light Strips with 3M Industrial Waterproof Adhesive Backing for front deck, (2) 15 LED/10" Blue Water LED Light Strips with 3M Industrial Waterproof Adhesive Backing for rear deck and (1) waterproof push-button switch.

Order No.	Mfg. No. / Description	List Price	
587422	(LEDBW106RDP) Red	\$184.39	FO-7092100
587426	(LEDBW106WDP) White	\$183.59	FO-1582100

T-H Marine L.E.D. Pontoon Lights - Blue Pontoon Light Set



- Flat flexible ribbon LED strip lights.
- IP68 - fully waterproof and submersible - silicone tube with silicone gel fill.
- Includes: (2) 20' or 25' long light strips, waterproof wiring harness and mounting channels.
- Mounts with adhesive strips pre-installed on mounting channels.

Order No.	Mfg. No. / Description	List Price	
3420154	(LED-PBDK20B-DP) 20' Strip for 16' to 22' Boats	\$426.99	E0-4202300
3420156	(LED-PBDK25B-DP) 25' Strip for 24' to 30' Boats	\$467.09	E0-2305300

T-H Marine Blue Water L.E.D. Extreme Pro Deck Lights



- Aluminum housing.
- 4' wire lead.
- Dimensions: 2.8" x 1.5".
- IP68 waterproof.
- 150° light dispersion angle.
- Voltage 9-30V DC.



BLUE WATER LED EXTREME PRO DECK LED LIGHTING SYSTEM

- Includes: (1) Extreme Pro Blue Water LED Deck Light, (1) flat surface mounting pad, (1) curved surface mounting pad, (2) machine mounting screws, (2) self-tapping mounting screws and (2) flat washers.

Order No.	Mfg. No. / Description	List Price	
587462	(LEDBW82-2-B-DP) Blue	\$80.99	FO-9665000
587466	(LEDBW822GDP) Green	\$80.29	FO-0265000
587470	(LEDBW822RDP) Red	\$80.29	FO-0265000
587474	(LEDBW822WDP) White	\$80.29	FO-0265000

BLUE WATER LED EXTREME PRO X2 MOTORGLOW LIGHTING SYSTEM

- These lights can be installed directly to your boats transom or on the motor jackplate.
- Includes: (2) Extreme Pro Blue Water LED Light, (2) flat surface mounting pad, (2) curved surface mounting pad, (4) machine mounting screws, (4) self-tapping mounting screws and (4) flat washers.

Order No.	Mfg. No. / Description	List Price	
587446	(LEDBW812BDP) Blue	\$148.09	FO-6630100
587454	(LEDBW812RDP) Red	\$146.89	FO-2820100
587458	(LEDBW812WDP) White	\$146.89	FO-2820100

BLUE WATER LED EXTREME PRO X6 DECK LED LIGHTING SYSTEM

- Includes: (6) Extreme Pro Blue Water LED Deck Light, (6) flat surface mounting pad, (6) curved surface mounting pad, (12) machine mounting screws, (12) self-tapping mounting screws and (12) flat washers.

Order No.	Mfg. No. / Description	List Price	
587430	(LEDBW802BDP) Blue	\$412.59	FO-1888200
587438	(LEDBW802RDP) Red	\$412.59	FO-1888200
587442	(LEDBW802WDP) White	\$412.59	FO-1888200

T-H Marine L.E.D. RGB Color Changing Pontoon Light Set



- IP68 - fully waterproof and submersible - silicone tube with silicone gel fill.
- Includes: IP68 RGB Controller with remote control, (2) 20' or 25' long light strips, waterproof wiring harness and mounting channels.
- Mounts with adhesive strips pre-installed on mounting channels.

Order No.	Mfg. No. / Description	List Price	
3420155	(LED-PBDK20RGB-DP) 20' Strip for 16' to 22' Boats	\$514.99	E0-4268300
3420157	(LED-PBDK25RGB-DP) 25' Strip for 24' to 30' Boats	\$596.99	E0-4774400

**Marpac L.E.D. RGBW Flexible Strip Lighting**



- RGBW LEDs combine red, green, blue and white LEDs to form a wide variety of colors.
- Add light to T-Tops, Gunwales, Center Consoles, Cabins, Hatches, Galley, Head, Auto, Home and More.
- Water resistant construction.
- 3M adhesive backing.
- Can be cut to custom length.
- Pig tail wire connection.
- Amp draw: 200mA (per foot).
- Length 18".

Order No.	Description	List Price	
7-39719	RGBW Flexible Strip Lighting	\$18.09	F0-6621000

**CONTROLLER**

- Controls RGBW light color and intensity.
- Hue slider for easy color selection.
- 4 preset pattern modes: Strobe, fast strobe, fade, fast fade.
- Quick buttons for red, green, blue and white.
- Illuminated power button.
- Smooth surface with a sleek design.



Order No.	Description	List Price	
7-33655	Controller	\$74.19	F0-3915000
7-32656	5 Conductor RGBW Wire	\$65.19	HO-1193000

**Marpac Pontoon Module LED Light Kits**



- High impact construction with 3M adhesive backing.
- Fully incased water resistant construction.
- 12" pigtail wire.
- Kit includes: (2) 28 module 28' strands + 12 foot pigtail 56 SS mini screws and 4 butt connectors.



Order No.	Description	List Price	
1-33630	White	\$213.69	HO-1282100
7-33631	Blue	\$200.89	F0-2604100

**T-H Marine 6' L.E.D. Rope Light Track with Mounting Tape**

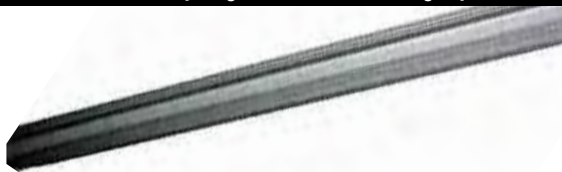

- The mounting channel is 6 feet long for versatile application.
- Strong adhesive backing ensures a secure attachment for reliable performance.

Order No.	Mfg. No. / Description	List Price	
3425231	(LED-SMSLC-6WT)	\$24.09	HO-5441000

**Boater Sports L.E.D. Flex Strip Lights**



- 4 watt LED rope light is perfect for creating sharp angles and definition lines in your boat or camper; super bright, outdoor or indoor use.
- Cool to touch when in use.
- LED lights last up to 20x longer than regular bulbs.
- Available in varying lengths and able to be trimmed to fit any size or shape.

Order No.	Description	List Price	
1-51920	White Length 12"	\$9.09	F0-6360000
1-51921	Blue Length 12"	\$10.49	F0-4370000
1-51922	Red Length 12"	\$9.99	G0-9660000
1-51923	Green Length 12"	\$9.99	G0-9660000
1-51678	White Length 24"	\$15.99	F0-9111000
1-51677	Blue Length 24"	\$18.29	F0-0821000
1-51924	Red Length 24"	\$19.49	F0-4631000
1-51925	Green Length 24"	\$19.49	F0-4631000
1-51932	Blue/White Length 24"	\$19.79	F0-5831000
1-51926	White Length 48"	\$24.49	F0-4171000
1-51927	Blue Length 48"	\$28.59	F0-1002000
1-51928	Red Length 48"	\$27.49	F0-4291000
1-51934	Blue/White Length 48"	\$32.89	F0-2032000
1-51672	White Length 72"	\$36.49	F0-4552000
1-51671	Blue Length 72"	\$39.39	F0-7572000
1-51931	Green Length 72"	\$44.39	F0-7013000
1-51936	Blue/White Length 72"	\$52.09	HO-5213000
1-51942	White Length 144"	\$80.19	F0-3165000
1-51943	Blue Length 144"	\$92.49	F0-4746000
1-51939	12' Flex Track (3) 4' with (6) End Caps	\$18.69	F0-8031000
7-51889	24' Flex Track (6) 4' with (12) End Caps	\$25.39	F0-7771000

**Marpac L.E.D. RGBW Light Kit**

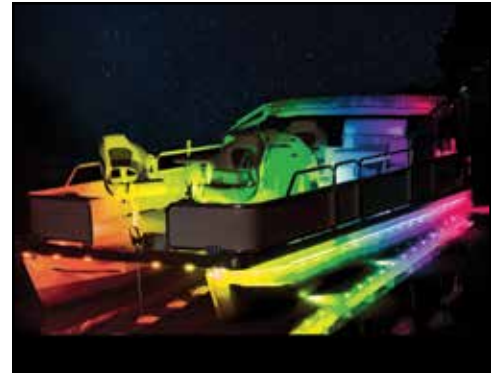

- RGBW Color Changing Technology.
- LED Light Kit for up to 48' of color changing, dimmable, elegant accent lighting for boats, RVs, porches, docks and decks.
- Includes Multi-Function Controller (7-33655).

Order No.	Description	List Price	
7-32683	LED RGBW Light Kit	\$361.99	F0-9335200

**CONTROLLER**

- Controls RGBW light color and intensity.
- Hue slider for easy color selection.
- 4 preset pattern modes: Strobe, fast strobe, fade, fast fade.
- Quick buttons for red, green, blue and white.
- Illuminated power button.
- Smooth surface with a sleek design.



Order No.	Description	List Price	
7-33655	Controller	\$74.19	F0-3915000
7-32656	5 Conductor RGBW Wire	\$65.19	HO-1193000

- Electronics
- Trolling Motors
- Instruments
- Electrical
- Lighting
- Anchor & Dock
- Safety
- Steering, Controls
- Pumps
- Fuel System
- Seating & Pedestals
- Trailering
- Tops & Covers
- Perform.
- Propellers
- Engine & Care
- Cleaning & Care
- Paint & Paint Acc.
- Fun & Flotation
- Topside Acc.
- Cockpit & Deck
- Hardware, Fasteners
- Camouflage
- Misc.
- Comm.

**Marpac L.E.D. High Intensity RGBW Underwater Light**



- RGBW LEDs combine red, green, blue and white LEDs to form a wide variety of colors to choose from.
- Stainless steel housing. Sealed and watertight.
- High lumens. Low amp draw.
- No burning filament. Pig tail wire connection.
- For underwater use only.
- Diameter 3.5", thick 0.8".

Order No.	Description	List Price	
7-51087	High Intensity RGBW Underwater Light	\$81.29	F0-0965000

**CONTROLLER**

- Controls RGBW light color and intensity.
- Hue slider for easy color selection.
- 4 preset pattern modes: Strobe, fast strobe, fade, fast fade.
- Quick buttons for red, green, blue and white.
- Illuminated power button.
- Smooth surface with a sleek design.



Order No.	Description	List Price	
7-33655	Controller	\$74.19	F0-3915000
7-32656	5 Conductor RGBW Wire	\$65.19	HO-1193000

**Marpac L.E.D. High Intensity Underwater Lights**

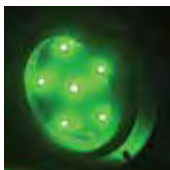

- Stainless steel housing.
- 6 Super bright LEDs.
- Sealed and watertight.
- High lumens.
- Low amp draw: .65 amps
- No burning filament.
- Pigtail wire connection.
- For underwater use only.
- Includes (3) stainless steel screws.
- Diameter 3-1/2".
- 12 volt.

Order No.	Description	List Price	
7-51094	White	\$74.99	F0-9425000
7-51095	Blue	\$74.99	F0-9425000
7-51097	Green	\$74.99	F0-9425000

**Marpac L.E.D. High Intensity Underwater Light (4 Colors)**



- Anodized aluminum housing with glass lens.
- 4 colors: Red, Green, Blue and White.
- No controller required - uses standard 2 position switch.
- Diameter 3.85", thick 0.85".

Order No.	Description	List Price	
7-39472	High Intensity Underwater Light	\$222.09	F0-6455100

**Marpac L.E.D. High Intensity RGBW Underwater Light**



- Anodized aluminum housing with glass lens.
- 58" tinned 5 wire lead.
- Diameter 3.85", thick 0.85".
- High lumens: R: 65, G: 120, B: 25, W: 180.
- Low amp draw: R: 350mA, G: 310mA, B: 340mA, W: 500mA.
- Works with separate RGBW Controller.
- 12 volt.

Order No.	Description	List Price	
7-39468	High Intensity RGBW Underwater light	\$220.39	F0-7245100

**CONTROLLER**

- Controls RGBW light color and intensity.
- Hue slider for easy color selection.
- 4 preset pattern modes: Strobe, fast strobe, fade, fast fade.
- Quick buttons for red, green, blue and white.
- Illuminated power button.
- Smooth surface with a sleek design.



Order No.	Description	List Price	
7-33655	Controller	\$74.19	F0-3915000
7-32656	5 Conductor RGBW Wire	\$65.19	HO-1193000

**Lumitec SeaBlaze Mini L.E.D. Underwater Light**



- Anodized aluminum finish.
- 670 Lumens.
- Leveraging many of the technologies utilized in the world's most popular underwater light, the SeaBlaze3, ensuring years of trouble free service.
- Diameter 3.9", depth 1.5".
- 990mA @ 12V DC. 450mA @ 24V DC.
- Sold as a pair.

Order No.	Mfg. No. / Description	List Price	
378860	(101246) Blue Non-Dimming	\$335.99	Z0-9273200

**MAP PRICE**

**Lumitec SeaBlaze Mini L.E.D. Underwater Light**



- Anodized aluminum finish.
- 670 Lumens.
- Packing all the features of its big brother the SeaBlazeX2 into a powerful little package, the SeaBlaze Mini Spectrum is perfect for smaller trailer boats and skiffs.
- Diameter 2.98", depth 0.63".
- 880mA @ 12V DC. 450mA @ 24V DC.
- Sold each.

Order No.	Mfg. No. / Description	List Price	
378768	(101832) RGBW Spectrum (Full-Color)	\$238.99	Z0-9886100

**NEW PRODUCT**

- Electronics
- Trolling Motors
- Instruments
- Electrical
- Lighting
- Anchor & Dock
- Safety
- Steering, Controls
- Pumps
- Fuel System
- Seating & Pedestals
- Trailering
- Tops & Covers
- Perform.
- Propellers
- Engine & Care
- Cleaning & Care
- Paint & Paint Acc.
- Fun & Flotation
- Topside Acc.
- Cockpit & Deck
- Hardware, Fasteners
- Camouflage
- Misc.
- Comm.

## Lumitec SeaBlaze Quattro L.E.D. Underwater Lights



- Marine grade bronze housing.
- Boasts more than 2,000 lumens.
- New cross fade mode.
- Available in dual-color and full RGBW Spectrum output.
- Diameter 3.85", depth .71".
- Mounting hole: 1/2".
- 2.1A @ 12V DC. 1.1A @ 24V DC.

**MAP  
PRICE**

Order No.	Mfg. No. / Description	List Price	
101180	(101511) Dual-Color - White/Blue	\$334.99	Z0-9982200
101175	(101510) RGBW Spectrum (Full-Color)	\$416.99	Z0-9048200

## Lumitec SeaBlaze X2 L.E.D. Underwater Lights



- Solid bronze construction.
- Delivers exceptional performance with over 6,000 lumens of output.
- Surface mount.
- Available in dual-color and full RGBW Spectrum output.
- Diameter 3.94", depth .85".
- 5A @ 12V DC. 2.5A @ 24V DC.

**MAP  
PRICE**

Order No.	Mfg. No. / Description	List Price	
101150	(101516) Dual-Color - White/Blue	\$457.99	Z0-9161300
101145	(101515) RGBW Spectrum (Full-Color)	\$686.99	Z0-9697400

## Marpac L.E.D. RGBW Aqua-Bright Underwater Light



- RGBW - combine red, green, blue and white LEDs to form a wide variety of colors to choose from.
- Perfect for T-Tops, trim tabs and transoms.
- Submersible - use below or above water.
- Dimensions: 3-1/2" L x 1-1/2" W.
- Low amp draw. No burning filament.
- Pigtail wire.
- Includes: Surface mount and stainless steel mounting hardware.
- 12 volt.

Order No.	Description	List Price	
7-51081	RGBW Aqua-Bright Underwater Light	\$35.59	F0-1942000

## CONTROLLER

- Controls RGBW light color and intensity.
- Hue slider for easy color selection.
- 4 preset pattern modes: Strobe, fast strobe, fade, fast fade.
- Quick buttons for red, green, blue and white.
- Illuminated power button.
- Smooth surface with a sleek design.



Order No.	Description	List Price	
7-33655	Controller	\$74.19	F0-3915000
7-32656	5 Conductor RGBW Wire	\$65.19	H0-1193000

## Lumitec Zambezi Mini Surface Mount Underwater Light - Spectrum



- Anodized aluminum finish.
- Perfect for smaller pontoons and skiffs, Zambezi Mini is small, easy to mount, easy on the wallet, yet packs a visual punch.
- Diameter 3", depth 1.2".
- 670 Lumens.
- 880mA @ 12V DC. 450mA @ 24V DC.
- Sold each.

**MAP  
PRICE**
**NEW  
PRODUCT**

Order No.	Mfg. No. / Description	List Price	
378772	(101833) RGBW Spectrum (Full-Color)	\$248.99	Z0-9857100

## Marpac L.E.D. Aqua-Bright Underwater Lights



- Perfect for T-Tops, trim tabs and transoms.
- Submersible - use below or above water.
- Dimensions: 3-1/2" L x 1-1/2" W.
- Low amp draw. No burning filament. Pigtail wire.
- Includes: Surface mount and stainless steel mounting hardware.
- 12 volt.

Order No.	Description	List Price	
7-51088	White	\$30.59	F0-1412000
7-51089	Blue	\$32.29	F0-0622000
7-51090	Green	\$30.59	F0-1412000

## Marpac L.E.D. High Intensity Underwater Light



- Precision fit stainless steel bezel.
- 6 Super bright LEDs.
- Low amp draw: .44 amps
- For underwater use only.
- Includes (2) stainless steel screws.
- Dimensions: 5.35" L x 1.83" W.
- 12 volt.

Order No.	Description	List Price	
7-51751	Blue	\$67.69	F0-8374000

## Attwood LighArmor™ L.E.D. Underwater Light



- Electro-polished 316 stainless steel cover.
- Low-profile design.
- Extreme impact-resistant lens.
- 6 LEDs.
- Exclusive Heat-Sync Cooling System with Active Overheat Protection.
- Resistant to corrosion, chemicals, and UV damage.
- 1,350 lumens.
- Length 5".
- 12V and 24V DC systems.
- Sold each.

**LIMITED  
QUANTITIES**

Order No.	Mfg. No. / Description	List Price	
1147209	(65UW06B-7) Sapphire Blue	\$235.09	E0-2367100

Electronics

Trolling Motors

Instruments

Electrical

Lighting

Anchor &amp; Dock

Safety

Steering, Controls

Pumps

Fuel System

Seating &amp; Pedestals

Trailer

Tops &amp; Covers

Perform.

Propellers

Engine &amp; Care

Cleaning &amp; Care

Paint &amp; Paint Acc.

Fun &amp; Flotation

Topside Acc.

Cockpit &amp; Deck

Hardware, Fasteners

Camouflage

Misc.

Comm.

**Marpac L.E.D. Baitwell Lights**



- Single LED diode accent lights provide as much light output as a conventional 12 volt incandescent bulb.
- Draws at least 10 times less power than incandescents.
- Completely sealed for use in livewells.
- Mounting hole: 7/8" diameter.
- 12 volt.

Order No.	Description	List Price	
7-0077	White	\$6.99	F0-9840000
7-0078	Blue	\$6.99	F0-9840000

**Boater Sports L.E.D. Stick-On Livewell Lights**



- 1" round, 3 LED's per light.
- Sealed epoxy back, wires connected to back.
- Waterproof.

Order No.	Mfg. No. / Description	List Price	
1-39421	(39421) White	\$5.89	F0-2140000
1-39422	(39422) Blue	\$5.89	F0-2140000

**LIMITED QUANTITIES**

**T-H Marine L.E.D. Flush Head Livewell Light**



- 1 super-bright LED with diffuser lens.
- Impact resistant lens with wide viewing angle.
- Waterproof, super bright LED designed for livewells, lockers or compartments.
- Can be used above or below the waterlevel with through wall mounting.
- Diameter 1-1/4". Requires 3/4" hole.
- Pigtail connection, 12 volt.

Order No.	Mfg. No. / Description	List Price	
642578	(LED-51875-DP) Blue	\$17.99	F0-9521000

**Boater Sports L.E.D. Round Front Position Lights**



Order No.	Mfg. No. / Description	List Price	
1-39483	(39483) Blue	\$2.79	F0-5910000
1-39484	(39484) White	\$2.79	F0-5910000

**LIMITED QUANTITIES**

Electronics

Trolling Motors

Instruments

Electrical

**Lighting**

**TACO Marine T-Top L.E.D. Tube Lights with Aluminum Housing**

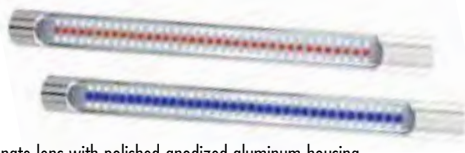

- 108 LED lights.
- Impact-resistant polycarbonate lens with polished anodized aluminum housing.
- 300 Lumens white light/150 Lumens color light.
- 3 way switch on end of light, toggles from color, to white, to off.
- IP67 waterproof (non-submersible) rating.
- Mounting clips included for easy installation.
- 14' of wiring cable.
- Dimensions: 16-1/2" x 1-5/8".

Order No.	Mfg. No. / Description	List Price	
444238	(F38-2050B-1) White with Blue Light	\$224.29	F0-0075100
444241	(F38-2050R-1) White with Red Light	\$224.29	F0-0075100

**Boater Sports L.E.D. Off Road Rail Light Bar**

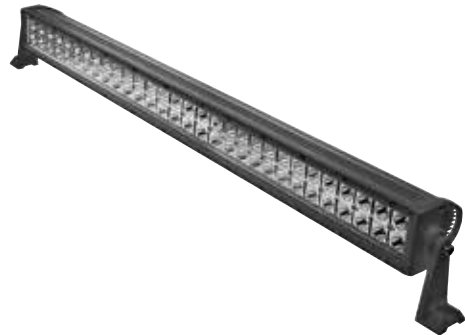

- High output LED rail light.
- Punishingly bright, these rail lights will meet your off road needs and then some.
- Incredibly efficient electrical engineering extends operation times past those of inferior lighting.
- Rugged aluminum housing and fully sealed LED construction means this light bar is here to stay.
- Fully sealed waterproof construction.
- Includes mounting bracket, hardware and instructions.
- 12 - 30V DC.
- Operating amperage: 15A @ 12V DC, 7.5A @ 24V DC.

Order No.	Mfg. No. / Description	LEDs	Lumens	List Price	
1-39739	(39739) Length 42"	(80) 3 watt	16800	\$481.29	F0-0963300

**LIMITED QUANTITIES**

**TACO Marine T-Top L.E.D. Tube Light**



- 108 LED lights.
- Impact-resistant polycarbonate lens.
- 300 Lumens white light/150 Lumens color light.
- 3 way switch on end of light, toggles from color, to white, to off.
- IP67 waterproof (non-submersible) rating.
- Mounting clips included for easy installation.
- 14' of wiring cable.
- Dimensions: 16-1/2" x 1-5/8".

Order No.	Mfg. No. / Description	List Price	
444242	(F38-2060R-1) White with Red Light	\$121.99	F0-9358000

**Anderson Marine Spot Light**



- Rubber molded housing cushions a flush-mount, par 36 sealed beam from shock and vibration.
- Universal 5/16" mounting stud and adjustable zinc-plated bracket allow mounting in any position.
- 10" lead wire exits through back of housing.
- Dimensions: 4-3/4" H x 3-1/2" D.

Order No.	Mfg. No. / Description	List Price	
223622	(3184)	\$33.99	F0-9732000

**LIMITED QUANTITIES**

**Attwood Multi-Function L.E.D. Spot Light**



- This durable, water-resistant, multi-purpose light can be used as a bright 300 Lumen flood light or 50 Lumen red beam for improved night vision.
- It also has a UV mode for charging fishing lures and line.
- Features four mounting options and 360° rotation.
- Includes an adapter for use with the Attwood Rod Holder Mount.
- Requires (6) AA batteries (Not included).

Order No.	Mfg. No. / Description	List Price	
235310	(14185XFS-7) Gray	\$59.09	F0-6314000

**LIMITED QUANTITIES**

Anchor & Dock

Safety

Steering, Controls

Pumps

Fuel System

Seating & Pedestals

Trailering

Tops & Covers

Perform.

Propellers

Engine & Care

Cleaning & Care

Paint & Paint Acc.

Fun & Flotation

Topside Acc.

Cockpit & Deck

Hardware, Fasteners

Camouflage

Misc.

Comm.

**Industrial LED Solutions L.E.D. Light - Polar Bear Series**

- The LED is clung to the enclosure, which can make the heat dissipation very fast. Lowering the junction temp.
- External constant current driver, ensures better heat dissipation.
- Copper free aluminum alloy enclosure. Has high anti-impact performance can endure a 20J impact.
- OSRAM LED source, high efficacy and lumen output.
- 100-240 volts AC.



Order No.	Mfg. No. / Description		Lumens	List Price	
601500	(PB80G) 80 watt	9570 Lumens	\$753.69	CO-4604600	
601505	(PB120G) 120 watt	13662 Lumens	\$1,026.39	CO-7257500	
601510	(PB240G) 240 watt	27280 Lumens	\$1,805.39	CO-8543510	

**LIGHT WITH STANCHION MOUNT PACKAGES**

Order No.	Mfg. No. / Description		Lumens	List Price	
601501	(80W POLAR) 80 watt	9570 Lumens	\$835.19	CO-1990700	
601506	(120W POLAR) 120 watt	13662 Lumens	\$1,107.89	CO-1714900	
601511	(140W POLAR) 240 watt	27280 Lumens	\$1,886.99	CO-4930610	

**STANCHION MOUNT**

Order No.	Mfg. No. / Description		List Price	
610515	(PB-BR-G) For 80/120 watt Fixtures	\$88.39	CO-3157000	
601520	(PB-BR-G) For 240 watt Fixtures	\$88.39	CO-3157000	

**Industrial LED Solutions L.E.D. Light - Swordfish Series**



Order No.	Mfg. No. / Description		Lumens	List Price	
601476	(SF48600-G) Length 24"	48 watt	5280	\$676.79	CO-7257500
601460	(SF561200) Length 48"	56 watt	6160	\$896.19	CO-6716700

**LIGHT WITH STANCHION MOUNT PACKAGES**

Order No.	Mfg. No. / Description		Lumens	List Price	
601477	(24 48W) Length 24"	48 watt	5280	\$746.69	CO-9643600
601461	(48 56W) Length 48"	56 watt	6160	\$956.09	CO-8621800

**WITH BATTERY BACKUP**

Order No.	Mfg. No. / Description		Lumens	List Price	
601480	(SF18/186000N) Length 24"	18/18 watt	1980	\$781.59	CO-5346600
601472	(SF561200-ONE) Length 48"	58/18 watt	6160	\$1,107.89	CO-1714900

**LIGHT WITH BATTERY BACKUP AND STANCHION MOUNT PACKAGES**

Order No.	Mfg. No. / Description		Lumens	List Price	
601481	(24 SWORD) Length 24"	18/18 watt	1980	\$851.49	CO-7732700
601473	(48 SWORD) Length 48"	58/18 watt	6160	\$1,177.69	CO-4010010

**STANCHION MOUNT**

Order No.	Mfg. No. / Description		List Price	
601484	(SF-BR)	\$75.89	CO-1546000	



- The LED is clung to the enclosure, which can make the heat dissipation very fast. Lowering the junction temp.
- Aluminum alloy enclosures gives high performance of anti-impact. Can endure a 10J impact.
- Copper-free aluminum enclosure, anti-corrosion. Suitable for many different applications and climates.
- OSRAM LED source, high efficacy and lumen output.
- 100-277 volts AC.

**Industrial LED Solutions L.E.D. Light - Golden Frog Series**

- Reduces the number of luminaries needed by providing excellent efficacy.
- Putting more light where you need it.
- Anti-Glare, Shock and Vibration resistant tempered Glass. Reduces risk of premature failure.
- Driver assemblies are designed to provide reliable operation even in the harshest environments.
- High strength aluminum alloy enclosure can endure 20J impact and is made for wet and corrosive environments.
- 100-240 volts AC.

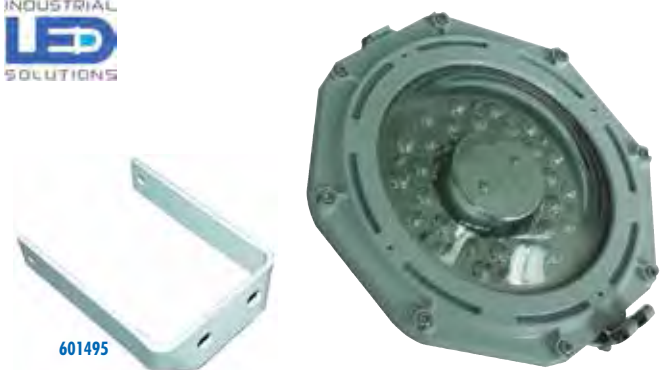

Order No.	Mfg. No. / Description		Lumens	List Price	
601490	(GF60-G) 60 watt	6160 Lumens	\$502.29	CO-5962400	

**STANCHION MOUNT**

Order No.	Mfg. No. / Description		List Price	
601495	(GF-BR-G)	\$38.09	CO-8323000	

- Electronics
- Trolling Motors
- Instruments
- Electrical
- Lighting
- Anchor & Dock
- Safety
- Steering, Controls
- Pumps
- Fuel System
- Seating & Pedestals
- Trailer
- Tops & Covers
- Perform.
- Propellers
- Engine & Care
- Cleaning & Care
- Paint & Paint Acc.
- Fun & Flotation
- Topside Acc.
- Cockpit & Deck
- Hardware, Fasteners
- Camouflage
- Misc.
- Comm.

- Electronics
- Trolling Motors
- Instruments
- Electrical
- Lighting
- Anchor & Dock
- Safety
- Steering, Controls
- Pumps
- Fuel System
- Seating & Pedestals
- Trailering
- Tops & Covers
- Perform.
- Propellers
- Engine & Care
- Cleaning & Care
- Paint & Paint Acc.
- Fun & Flotation
- Topside Acc.
- Cockpit & Deck
- Hardware, Fasteners
- Camouflage
- Misc.
- Comm.

**McDermott High Power L.E.D. Floodlight**



- High powered LED deck lights.
- 120, 140 and 200W.
- LED's rated for 50,000 hours.
- 16,000 - 12,000 lumens.
- 200W LED Floodlight.
- Stainless steel mounting bracket.

Order No.	Mfg. No. / Description	List Price	
<b>454936</b>	(TBFLD200WLED)	<b>\$964.29</b>	BO-6876800

**McDermott L.E.D. Floodlights - 120VAC**



454912

454924

- Power efficient LED deck lights for the marine industry.
- Certified as meeting UL 1598A.
- Double power coated diecast aluminum housing rated IP68.
- Stainless steel hardware and mounting bracket.
- LED's rated for 50,000 hours.
- Serviceable in the U.S. with most components easily replaced.
- 120 VAC lights with grounded plug.

Order No.	Mfg. No. / Description		List Price	
<b>454912</b>	(TBFLD50WLED)	50 watts	<b>\$244.39</b>	BO-5991200
<b>454919</b>	(TBFLD80WLED)	80 watts	<b>\$359.89</b>	BO-0932300
<b>454924</b>	(TBFLD100WLED)	100 watts	<b>\$463.09</b>	BO-8761400

**Perko High Performance L.E.D. Floodlights - Lightship 50**



526194

526190

- 7,500 Lumens (Approx. at 12V DC).
- 5000K neutral white optics.
- Marine grade aluminum mounting bracket included.
- Beam angle: 80°.
- Voltage: 12V DC, 24V DC, 32V DC auto detect.
- Current draw: 3.8A at 12V DC / 1.9A at 24V DC.
- Total power consumption: 50 watts at 12V DC.
- Dimensions: 7" x 5.5" x 1.9" (with bracket).

Order No.	Mfg. No. / Description	List Price	
<b>526190</b>	(1643050FOW) White	<b>\$670.29</b>	A0-9207600
<b>526194</b>	(1643050FOB) Black	<b>\$670.29</b>	A0-9207600

**NEW PRODUCT**

**POWER SUPPLY**

- Rugged reliable power supply for vessels using AC powered lighting.
- "Out of weather" installation required. Output rating: 60 watt.

Order No.	Mfg. No. / Description	List Price	
<b>526230</b>	(1679050)	<b>\$216.99</b>	A0-9961200

**McDermott L.E.D. Floodlight - 12VDC**



- High powered deck lights for the marine industry.
- Certified as meeting UL 1598A.
- Double power coated diecast aluminum housing rated IP68.
- Stainless steel hardware and mounting bracket.
- LED's rated for 50,000 hours.
- Serviceable in the U.S. with most components easily replaced.
- 12 volt. 50 watts.

Order No.	Mfg. No. / Description	List Price	
<b>454915</b>	(TBFLD50W12LDC)	<b>\$308.49</b>	BO-4677200

**Perko High Performance L.E.D. Floodlight - Lightship 100**



- 13,300 Lumens (Approx. at 12V DC).
- 16,670 Lumens (Approx. at 24V DC).
- 5000K neutral white optics.
- Marine grade aluminum mounting bracket included.
- Beam angle: 76°.
- Voltage: 12V DC, 24V DC, 32V DC auto detect.
- Current draw: 8.8A at 12V DC / 5.7A at 24V DC.
- Total power consumption: 1100 watts at 12V DC.
- Dimensions: 12.9" x 9.5" x 3.1" (with bracket).

Order No.	Mfg. No. / Description	List Price	
<b>526202</b>	(1643100FOB) Black	<b>\$1,542.19</b>	A0-9124510

**NEW PRODUCT**

**POWER SUPPLY**

- Rugged reliable power supply for vessels using AC powered lighting.
- "Out of weather" installation required. Output rating: 185 watt.

Order No.	Mfg. No. / Description	List Price	
<b>526232</b>	(1679100)	<b>\$333.69</b>	A0-9633300

**Aqua Signal Commercial Halogen Floodlight**



- Deep drawn seamless stainless steel housing.
- Powder coated white enamel.
- Clear safety glass.
- Cable entry: Brass cable gland.
- Dimensions: 14.8" L x 7.6" W x 12.8 H".
- Adjustable bracket with 4 mounting holes.
- Approvals: UL1598 and 1598A, USCG Accepted.
- 120/220 volt, 500 watt.
- Note: Bulb not included.

Order No.	Mfg. No. / Description	List Price	
<b>210500</b>	(1069040)	<b>\$563.89</b>	F0-2749300
<b>210501</b>	(992018) Spare Lampholder (2 PC)	<b>\$103.19</b>	F0-3227000

**Marpac Halogen Floodlight**



7-9001



- Stainless steel bracket with hardware and nylon housing.
- Dimensions: 4-1/2" x 7".
- Mounts with 1/4" screw.
- H3, 12 volt, 55 watt halogen bulb (7-9001).

Order No.	Description	List Price	
<b>7-0043</b>	Halogen Floodlight	<b>\$37.59</b>	F0-1362000
<b>7-9001</b>	Spare Bulb	<b>\$5.09</b>	F0-6530000

## TACO Marine (4) L.E.D. Deck Light



- Anodized aluminum heatsink.
- UV-resistant polycarbonate housing.
- Durable and self-extinguishing clear plastic lens.
- 10.0 watt equivalent to a 55 watt halogen flood light.
- Powerful 700 lumen output with 100° spread beam angle.
- 12-24 volt applications.
- 8' hidden power cable.
- Mounting options: Stainless steel swivel bracket or 3M adhesive tape.
- Compact design bolts directly to any flat surface 5" long and 1-3/8" width.
- LED chips are silicone potted for IP67 Waterproof (non-submersible).
- USCG, ISO and SAE certified for ignition protection.
- Sold each.

Order No.	Mfg. No. / Description	List Price	
<b>444253</b>	(F38-8800W-1)	<b>\$137.89</b>	F0-2569000

## Lumitec Maxillume h60 - Trunnion Mount L.E.D. Floodlight



- White finish.
- Lumens: 6,000.
- Correlated color temperature: 5,000.
- Dimensions: 7.13" W x 3.15" H x 2.6" D.
- Voltage: 10 to 30V DC.
- IP67 Compliant.
- Sold each.

Order No.	Mfg. No. / Description	List Price	
<b>378874</b>	(101334) White Dimming	<b>\$554.99</b>	Z0-9999300

**MAP  
PRICE**

## Lumitec Caprera2 - Bracket Mount L.E.D. Floodlights



- White finish.
- Lumens: 1,000.
- Correlated color temperature: 5,000.
- Dimensions: 4.49" W x 1.98" H x 2.58" D.
- Voltage: 10 to 30V DC.
- IP67 Compliant.
- Sold each.

Order No.	Mfg. No. / Description	List Price	
<b>378842</b>	(101102) White and Blue Dimming	<b>\$202.99</b>	Z0-9234100
<b>378845</b>	(101103) White and Red Dimming	<b>\$202.99</b>	Z0-9234100

**MAP  
PRICE**

## Lumitec Capreralt - L.E.D. Floodlight



- White finish.
- Compatible with most PWM LED dimmers.
- White Non-Dimming.
- Lumens: 1,000.
- Correlated color temperature: 5,000.
- Dimensions: 4.49" W x 1.98" H x 2.58" D.
- Voltage: 10 to 30V DC.
- IP67 Compliant.
- Sold each.

Order No.	Mfg. No. / Description	List Price	
<b>378831</b>	(101292)	<b>\$115.99</b>	Z0-9168000

**MAP  
PRICE**

## Marpac L.E.D. Advantage Floodlights



- 5 high power LED's produce 1050 Lumens of super bright coverage.
- Expected life of more than 22,000 hours.
- Completely sealed and water resistant to IP 67 specifications.
- Rugged die cast, powder coated aluminum housing with stainless steel mounting hardware.
- Measures approximately 1-7/8" H x 5-3/4" - about half the size of halogens.
- 12 volt.
- Sold each.

Order No.	Description	List Price	
<b>7-0037</b>	White	<b>\$46.79</b>	F0-5723000
<b>7-0038</b>	Black	<b>\$46.79</b>	F0-5723000

## Lumitec Caprera - Bracket Mount L.E.D. Cockpit Floodlight



- Powder white coated die cast aluminum housing.
- Lumens: 530.
- Correlated color temperature: 6,500.
- Dimensions: 4.49" W x 1.65" H x 2.83" D.
- Voltage: 10 to 30V DC.
- IP67 Compliant.
- Sold each.

Order No.	Mfg. No. / Description	List Price	
<b>378830</b>	(101040) White Dimming	<b>\$169.99</b>	Z0-9263100

**MAP  
PRICE**

## Lumitec Capri2 - Flush Mount L.E.D. Floodlights



- White finish.
- Lumens: 1,000.
- Correlated color temperature: 5,000.
- Dimensions: 4.94" W x 1.75" H x 1.57" D.
- Voltage: 10 to 30V DC.
- IP67 Compliant.
- Sold each.

Order No.	Mfg. No. / Description	List Price	
<b>378836</b>	(101099) White and Blue Dimming	<b>\$206.99</b>	Z0-9054100
<b>378839</b>	(101100) White and Red Dimming	<b>\$228.99</b>	Z0-9706100

**MAP  
PRICE**

## Lumitec Capri3 - Flush Mount L.E.D. Floodlights



- White finish.
- Powder coated die cast aluminum housing.
- Lumens: 1,200.
- Correlated color temperature: 5,000.
- Dimensions: 4.08" W x 1.39" H x 1.43" D.
- Voltage: 10 to 30V DC.
- Includes innovative easy fit butterfly clip mounting system.
- IP67 compliant and PLI enabled (Poco compatible).
- Sold each.

Order No.	Mfg. No. / Description	List Price	
<b>378847</b>	(101720) RGBW Spectrum	<b>\$213.99</b>	Z0-9494100
<b>378849</b>	(101721) White and Blue Dimming	<b>\$190.99</b>	Z0-9233100

**MAP  
PRICE**

**NEW  
PRODUCT**

Electronics

Trolling Motors

Instruments

Electrical

Lighting

Anchor & Dock

Safety

Steering, Controls

Pumps

Fuel System

Seating & Pedestals

Trailering

Tops & Covers

Perform.

Propellers

Engine & Care

Cleaning & Care

Paint & Paint Acc.

Fun & Flotation

Topside Acc.

Cockpit & Deck

Hardware, Fasteners

Camouflage

Misc.

Comm.



Rigid D-Series Pro L.E.D. Spreader Lights



202084



2003706



202218



340154

- 50,000 Plus Hour lifespan.
- 9-36V DC.
- Durable UV resistant powder coat.
- High grade aluminum alloy.
- Integrated thermal management system.
- Impact resistant polycarbonate lens.
- Over/under voltage protection.
- IP68 Compliant - Dust/water ingress
- SAE J575 Compliant - Shock/vibration.
- Dimensions: 3.2" W x 3" H x 3.2" D.



Electronics

Trolling Motors

Instruments

Electrical

Lighting

Anchor & Dock

Safety

Steering, Controls

Pumps

Fuel System

Seating & Pedestals

Trailer

Tops & Covers

Perform.

Propellers

Engine & Care

Cleaning & Care

Paint & Paint Acc.

Fun & Flotation

Topside Acc.

Cockpit & Deck

Hardware, Fasteners

Camouflage

Misc.

Comm.

Order No.	Mfg. No.	Optics	Color	Sold	Mounting Type	Watts	AMP Draw	Raw Lumens	Lux @ 10 meters	Beam Distance @ 1 lux	Beam Distance @ .25 Lux	List Price	
340154	(602513)	Flood Diffused	White	Per Pair	Surface	30	2.14	3168	20.6	45.4	90.8	\$255.09	E0-2319100
2003708	(202513)	Flood Diffused	Black	Per Pair	Surface	30	2.14	3168	20.6	45.4	90.8	\$255.09	E0-2319100
202218	(611513)	Flood Diffused	White	Each	Flush	30	2.14	3168	20.6	45.4	90.8	\$60.00	E0-0054000
2003715	(602113)	Flood	White	Per Pair	Surface	30	2.14	3168	58.19	76.3	152.6	\$264.99	E0-4789100
2003706	(202113)	Flood	Black	Per Pair	Surface	30	2.14	3168	58.19	76.3	152.6	\$255.09	E0-2319100
202084	(602213)	Spot	White	Per Pair	Surface	30	2.14	3168	712.97	268.7	537.4	\$264.99	E0-4789100
2003707	(202213)	Spot	Black	Per Pair	Surface	30	2.14	3168	712.97	268.7	537.4	\$255.09	E0-2319100

Rigid SR-M Pro Series L.E.D. Spreader Lights



2003732



2003726



2003723

- 50,000 Plus Hour lifespan.
- 9-36V DC.
- Durable UV resistant powder coat.
- High grade aluminum alloy.
- Integrated thermal management system.
- Impact resistant polycarbonate lens.
- Over/under voltage protection.
- IP68 Compliant - Dust/water ingress
- SAE J575 Compliant - Shock/vibration.
- Surface mount.
- Dimensions: 3" W x 1.8" H x 2.4" D.



Order No.	Mfg. No.	Pattern	Color	Sold	Watts	AMP Draw	LEDs	Raw Lumens	Lux @ 10 meters	Beam Distance @ 1 lux	Beam Distance @ .25 Lux	List Price	
2003723	(902513)	Flood Diffused	Black	Each	16	1.14	2	1584	18.3	42.8	85.6	\$189.99	E0-9424100
2003726	(912313)	Driving	Black	Each	23	1.64	3	2376	107.38	103.6	207.2	\$251.09	E0-2388100
2003732	(902213)	Spot	Black	Each	15	1.07	2	1584	348.41	186.1	372.2	\$189.99	E0-9424100

Rigid SR-Q Pro Series L.E.D. Flood Light



- 50,000 Plus Hour lifespan.
- 9-36V DC.
- Durable UV resistant powder coat.
- High grade aluminum alloy.
- Integrated thermal management system.
- Impact resistant polycarbonate lens.
- Over/under voltage protection.
- IP68 Compliant - Dust/water ingress
- SAE J575 Compliant - Shock/vibration.
- Surface mount.
- Dimensions: 5" W x 1.8" H x 2.23" D.

Order No.	Mfg. No.	Pattern	Color	Sold	Watts	AMP Draw	LEDs	Raw Lumens	Lux @ 10 meters	Beam Distance @ 1 lux	Beam Distance @ .25 Lux	List Price	
202220	(904113)	Flood	Black	Each	32	2.29	4	3168	69.24	83.2	166.4	\$92.00	E0-0096000

NEW PRODUCT

Rigid SR-Series Pro Single Row L.E.D. Light Bars



- 50,000 Plus Hour lifespan.
- 9-36V DC.
- Durable UV resistant powder coat.
- High grade aluminum alloy.
- Integrated thermal management system.
- Impact resistant polycarbonate lens.
- Over/under voltage protection.
- IP68 Compliant - Dust/water ingress
- SAE J575 Compliant - Shock/vibration.
- Surface mount.
- Dimensions: 1-3/4" H x 3" D.



Order No.	Mfg. No.	Optics	Size	Color	Sold	Watts	AMP Draw	LEDs	Row Lumens	Lux @ 10 meters	Beam Distance @ 1 lux	Beam Distance @ .25 Lux	List Price	NEW MODELS
2003724	(906213)	Spot	6"	Black	Each	48	3.43	6	4752	1110.04	333.2	666.3	\$287.89	E0-2951200
2003725	(910313)	Spot/Flood	10"	Black	Each	60	4.29	10	7920	899.37	299.9	599.8	\$365.09	E0-2837200
202210	(330314)	Spot/Flood	30"	White	Each	160	11.43	30	18810	2968	545	1090	\$387.00	E0-5209200
202214	(350314)	Spot/Flood	50"	White	Each	290	20.71	50	31350	4347	659	1319	\$581.00	E0-5753400

Rigid Marine E-Series Pro L.E.D. Light Bars



- 50,000 Plus Hour lifespan.
- 9-36V DC.
- Durable UV resistant powder coat.
- High grade aluminum alloy.
- Integrated thermal management system.
- Impact resistant polycarbonate lens.
- Over/under voltage protection.
- IP68 Compliant - Dust/water ingress
- SAE J575 Compliant - Shock/vibration.
- Surface mount.
- Height 2.7".



Order No.	Mfg. No.	Optics	Size	Color	Sold	Watts	AMP Draw	LEDs	Row Lumens	Lux @ 10 meters	Beam Distance @ 1 lux	Beam Distance @ .25 Lux	List Price	
2003700	(104113)	Flood	4"	Black	Each	61	4.36	8	6336	128	113	226	\$299.39	E0-4542200
202362	(110113)	Flood	10"	Black	Each	185	13.21	20	15840	286	169	338	\$505.19	E0-9887300
2003701	(106213)	Spot	6"	Black	Each	85	6.07	12	9504	2131	462	923	\$390.79	E0-9039200
2003702	(110213)	Spot	10"	Black	Each	168	12	20	15840	3368	580	1160	\$486.19	E0-4646300
340158	(806313)	Spot/Flood	6"	White	Each	82	5.86	12	9504	829	288	576	\$376.19	E0-4128200
202402	(810313)	Spot/Flood	10"	White	Each	165	11.79	20	15840	2003	448	895	\$505.19	E0-9887300
2003703	(120313)	Spot/Flood	20"	Black	Each	214	15	40	25080	3898	624	1249	\$838.29	E0-2782600
202452	(820313)	Spot/Flood	20"	White	Each	214	15	40	25080	3898	624	1249	\$871.19	E0-9335600

- Electronics
- Trolling Motors
- Instruments
- Electrical
- Lighting
- Anchor & Dock
- Safety
- Steering, Controls
- Pumps
- Fuel System
- Seating & Pedestals
- Trailering
- Tops & Covers
- Perform.
- Propellers
- Engine & Care
- Cleaning & Care
- Paint & Paint Acc.
- Fun & Flotation
- Topside Acc.
- Cockpit & Deck
- Hardware, Fasteners
- Camouflage
- Misc.
- Comm.

**Attwood L.E.D. Docking Lights**



- The Attwood product also transmits light in a much broader pattern as opposed to a narrow beam generated by today's competitors.
- At 1.2" thick, the lights are designed to be mounted directly to the surface of the hull.
- Surface mount - only a small hole for wiring and three (3) screws for attachment.
- Allows for fewer hull cuts and minimal intrusion.
- Stainless steel and aluminum components to ensure the product is resistant to corrosion.
- The rubber gasket provided creates a barrier that protects your hull from water entry.
- Packaged per pair.

Order No.	Mfg. No. / Description	List Price
<b>235572</b>	(6522SS7) Stainless Steel Bezel	<b>\$175.49</b> E0-2613100
<b>2350119</b>	(6523BK7) Black Powder Coat Bezel	<b>\$173.49</b> E0-2103100

**Boater Sports L.E.D. Portable Fishing Light**



- Suction mount UV fishing light.
- Easily mount and remove.
- Attract bait and fish.
- LED strip adjusts 180 degrees.
- 12 volt power plug.
- No wiring required.
- 2 light modes: Green and UV.

**LIMITED QUANTITIES**

Order No.	Mfg. No. / Description	List Price
<b>1-34128</b>	(34128)	<b>\$32.29</b> D0-3852000

**Night Stick Intrinsicly Safe Dual-Light™ Multi-Function L.E.D. Headlamp**



- Engineered polymer housing.
- cETLus, ATEX, IECEx and MSHA listed Intrinsicly Safe Permissible.
- CREE LED technology - 50,000 + hours LED life.
- Dual switches located on top of light.
- Adjustable ratchet tilt head.
- Non-slip elastic head strap.
- Multi-function features: Spotlight, full-power white floodlight, half-power white floodlight, red floodlight and dual-light (spotlight and white floodlight on at the same time) for maximum versatility.
- Heavy duty rubber strap for hard hat applications.
- Waterproof. Impact and chemical resistant.
- Powered by: 3 "AA" batteries (included).
- Green.

Order No.	Mfg. No. / Description	List Price
<b>578155</b>	(XPP-5456G)	<b>\$57.79</b> D0-3264000

**Marpac Solar Dock/Deck Light**



- Solar Dock/Deck Light with three position switch (flashing- on - off).
- Heavy duty cast aluminum frame.
- Waterproof construction.
- 8 hours of sunlight to fully charge.

Order No.	Description	List Price
<b>7-34162</b>	Solar Dock/Deck Light	<b>\$27.19</b> G0-2281000

**Marpac On/Off Switch Panel for Headlight**



- Used for lights, blowers, aerators, bilge pumps, etc.
- Water resistant toggle boot.
- Corrosion resistant brass switch, accommodates up to 1.18" thick panel.
- Rated: 10 amps @ 12V DC.
- Dimensions: 1.85" W x 2.48" L.

Order No.	Description	List Price
<b>7-51381</b>	On/Off Switch Panel for Headlight	<b>\$13.89</b> F0-2790000

**Marpac L.E.D. Waterproof Rechargeable Utility Light**



- 60 super bright LEDs.
- Lasts up to nine hours on a full charge.
- Hang where needed with the swivel hook.
- Floats if dropped overboard.
- Waterproof to IP:67 standards-total immersion in water up to one meter for 30 minutes.
- Crush and dust proof.
- Magnetic holder included.
- Cordless convenience-no power wires in the work area.
- AC and 12V DC chargers included.
- Recharges in approximately six hours.

**LIMITED QUANTITIES**

Order No.	Description	List Price
<b>7-0040</b>	LED Rechargeable Utility Light	<b>\$40.79</b> F0-5582000

**Night Stick Intrinsicly Safe Dual-Light™ Multi-Function L.E.D. Headlamp**



- Engineered polymer housing.
- cETLus, ATEX and IECEx listed Intrinsicly Safe.
- CREE LED technology - 50,000 + hours LED life.
- Dual switches located on top of light.
- Adjustable ratchet tilt head.
- Non-slip elastic head strap.
- Multi-function features: High/low-brightness spotlight, high/low-brightness floodlight and dual-light (spotlight and white floodlight on at the same time) for maximum versatility.
- Heavy duty rubber strap for hard hat applications.
- Waterproof. Impact and chemical resistant.
- Powered by: 3 "AAA" batteries (included).
- Green.

Order No.	Mfg. No. / Description	List Price
<b>578150</b>	(XPP-5454G)	<b>\$49.79</b> D0-3893000

- Electronics
- Trolling Motors
- Instruments
- Electrical
- Lighting
- Anchor & Dock
- Safety
- Steering, Controls
- Pumps
- Fuel System
- Seating & Pedestals
- Trailering
- Tops & Covers
- Perform.
- Propellers
- Engine & Care
- Cleaning & Care
- Paint & Paint Acc.
- Fun & Flotation
- Topside Acc.
- Cockpit & Deck
- Hardware, Fasteners
- Camouflage
- Misc.
- Comm.

**Energizer Vision HD L.E.D. Headlight**



- 3 headlamp light modes - White spot light, white flood light and spot and flood together.
- Dimmable to control brightness and runtime.
- Powerful LED headlamp beam.
- Pivots to direct light where you need it.
- Water resistant with a shatterproof lens. Ideal as hard hat lights.
- Includes 3 "AAA" batteries.
- Red.

Order No. Mfg. No. / Description List Price  
**340104** (HDBIN32E) **\$28.39** HO-3071000

**Night Stick Mini-TAC Gooseneck L.E.D. Flashlight**



- CREE LED technology - 50,000 + hours LED life.
- Momentary or constant-on flashlight.
- Aircraft-grade 6061-T6 aluminum. Non-slip grip.
- Water resistant. Impact and chemical resistant.
- Powered by: 2 "AA" batteries (included).
- Includes removable wrist lanyard, hands-free magnet and batteries.

Order No. Mfg. No. / Description List Price  
**578120** (MT-130) **\$23.39** D0-1781000

**Night Stick Intranit® Intrinsicly Safe Dual-Light™ Angle Light**



- cETLus, ATEX, IECEx and INMETRO certified Intrinsicly Safe.
- Flashlight - floodlight - Dual-Light.
- LED technology - 50,000 + hours LED life.
- 8 user-selectable brightness settings for the Flashlight and Floodlight including a 20 Lumen Survival Mode.
- High-efficiency deep parabolic reflector creating a sharp focused flashlight beam.
- Dual-Light (flashlight & floodlight at same time) for maximum versatility.
- Glass-filled nylon polymer housing.
- Dual body switches.
- Heavy duty stainless steel pocket clip.
- Battery charge status indicator (for use only with rechargeable battery).
- IP-67 Dustproof/waterproof. Impact and chemical resistant.
- Operates on (3) "AA" Alkaline batteries (Included).
- Length 6.6".
- Yellow.

Order No. Mfg. No. / Description List Price  
**578160** (XPP5566GX) **\$91.49** D0-9137000

**Night Stick Intrinsicly Safe L.E.D. Penlight**



- Engineered polymer housing.
- cETLus, ATEX & IECEx listed Intrinsicly Safe.
- LED technology - 50,000 + hours LED life.
- Momentary or constant-on flashlight.
- Sharp focused beam for distance illumination.
- Non-slip grip. Single body switch.
- IP-67 dustproof/waterproof. Impact and chemical resistant.
- Built-in pocket/belt clip.
- Operates on (3) "AAAA" Alkaline batteries (Included).
- Length 6.8".
- Yellow.

Order No. Mfg. No. / Description List Price  
**578135** (XPP-5412G) **\$20.89** D0-1761000

**LIMITED QUANTITIES**

**Pelican Lamp Module**



- Lamp module for use with MityLite 1900 Flashlight.

Order No. Mfg. No. / Description List Price  
**511229** (1904) **\$8.98** G0-2060000

**LIMITED QUANTITIES**

**Night Stick Intrinsicly Safe Permissible Dual-Light™ L.E.D. Flashlight**



- cETLus, ATEX, IECEx, INMETRO and MSHA listed Intrinsicly Safe Permissible.
- Flashlight - floodlight - Dual-Light.
- LED technology - 50,000 + hours LED life.
- Momentary or constant-on flashlight.
- Sharp focused flashlight beam for distance illumination.
- Unfocused wide-beam floodlight for close-up illumination.
- Dual-Light (flashlight & floodlight at same time) for maximum versatility.
- Engineered polymer housing.
- Non-slip grip. Dual body switches.
- IP-67 Dustproof/waterproof. Impact and chemical resistant.
- Built-in pocket/belt clip.
- Includes removable lanyard.
- Operates on (3) "AA" Alkaline batteries (Not included).
- Length 7".
- Yellow.

Order No. Mfg. No. / Description List Price  
**578140** (XPP-5422G) **\$42.99** D0-9343000

**DUAL-LIGHT™ L.E.D. FLASHLIGHT WITH DUAL MAGNETS**

- Powerful integrated magnets built into the base and pocket clip for multiple hands-free options.

Order No. Mfg. No. / Description List Price  
**578145** (XPP-5422GM) **\$44.69** D0-5753000

- Electronics
- Trolling Motors
- Instruments
- Electrical
- Lighting
- Anchor & Dock
- Safety
- Steering, Controls
- Pumps
- Fuel System
- Seating & Pedestals
- Trailer
- Tops & Covers
- Perform.
- Propellers
- Engine & Care
- Cleaning & Care
- Paint & Paint Acc.
- Fun & Flotation
- Topside Acc.
- Cockpit & Deck
- Hardware, Fasteners
- Camouflage
- Misc.
- Comm.

**Energizer Intrinsicly Safe® L.E.D. Flashlight**

**Energizer**



- Shatterproof lens.
- Ribbed casing for secure grip.
- Runtime: 65 hours.
- Brightness: 150 lumens. Beam distance: 175m.
- Waterproof up to 1m. Impact resistant up to 1m.
- Built for safe use in environments with water, gas and dust (IP67).
- Class I Groups A, B, C and D, Class II Groups E, F and G and Class III rated.
- Operates on (2) "D" Alkaline batteries (Not included).
- Safety orange.

Order No.	Mfg. No. / Description	List Price	
340238	(ENISHH25E)	\$45.29	HO-7172000

**Energizer Industrial Heavy Duty L.E.D. Flashlight**

**Energizer**



- Weatherproof and shockproof.
- An impact-resistant housing reduces the chance of breakage from dropping and abuse and the chemical-resistant polypropylene body protects it from staining and corrosion.
- A built-in hanger ring makes it easy to keep this sturdy light within reach.
- Runtime (h:mm): 113.
- One white LED provides 35 lumens of light.
- Operates on (2) "D" Alkaline batteries. (Not included).
- Yellow.

Order No.	Mfg. No. / Description	List Price	
340226	(1251L)	\$10.09	HO-5060000

**Energizer Industrial Economy Flashlight**

**Energizer**



- Sturdy polyethylene case and a shatterproof lens.
- Runtime (h:mm): 2:30.
- Krypton (KPR-102) bulb delivers 17 lumens.
- Flip-up hook that allows hanging or belt-carrying the light easily.
- The anti-roll feature helps keep the light in place when you set it down.
- Operates on (2) "D" Alkaline batteries. (Not included).
- Yellow.

Order No.	Mfg. No. / Description	List Price	
340199	(E250Y)	\$4.99	HO-9920000

**LIMITED QUANTITIES**

**Fulton Waterproof Flashlight**

**FULTON**



- Class II Group G and Class I Group C, D Approved.
- Approved for hazardous areas of atmosphere.
- Orange body with black lens ring and end cap.
- Waterproof.
- 3 position switch, switch guard and spare bulb.
- Operates on (3) "D" Alkaline batteries (Not included).

Order No.	Mfg. No. / Description	List Price	
261736	(932-1B)	\$30.29	HO-7181000

**Aqua Signal Bremen Searchlight**

**aqua signal**



- Black elastic rubber housing that is non-corrosive, non-magnetic and is completely submersible (IP68).
- SOLAS approved searchlight.
- Morse code capable.
- On/off switch.
- 10' pigtail cable.
- 12 volt. Uses 50 W halogen bulb, included.

Order No.	Mfg. No. / Description	List Price	
207298	(3313004000)	\$248.19	GO-9266100

**T-Bracket for Emergency Battle Lanterns**



- T-bracket for emergency battle lanterns.

Order No.	Mfg. No. / Description	List Price	
696368	(SMY2546)	\$35.49	GO-8732000

**Energizer MAX Alkaline "D" Cell Battery**

**Energizer**



- Up to 10 years shelf life.
- Sold 2 per pack.

**LIMITED QUANTITIES**

Order No.	Mfg. No. / Description	List Price	
340251	(E95BP-2)	\$11.69	HO-1070000

**Eveready Super Heavy Duty Carbon Zinc "D" Cell Battery**

**EVEREADY**



- Sold each.

Order No.	Mfg. No. / Description	List Price	
340175	(1250(EV150))	\$1.99	HO-9110000

**Energizer Ultimate Lithium Alkaline "AA" Cell Battery**

**Energizer**



- Sold 2 per pack.

Order No.	Mfg. No. / Description	List Price	
340245	(L91.9S)	\$5.89	HO-3530000

**6 Volt Lantern Batteries**



340214



340125

- Sold each.

Order No.	Mfg. No. / Description	List Price	
340125	(1209(EV190))	\$9.89	HO-3950000
340214	(945R4)	\$15.09	HO-5090000

**Energizer Industrial Alkaline Batteries**

**Energizer**



- Sold each.

Order No.	Mfg. No. / Description	List Price	
340113	(EN22) 9 Volt Battery	\$3.99	HO-9320000
340137	(EN91) "AA" Cell Battery	\$1.09	HO-5600000
340149	(EN92) "AAA" Cell Battery	\$1.09	HO-5600000
340151	(EN93) "C" Cell Battery	\$2.09	HO-5210000
340163	(EN95) "D" Cell Battery	\$3.19	HO-1910000

- Electronics
- Trolling Motors
- Instruments
- Electrical
- Lighting
- Anchor & Dock
- Safety
- Steering, Controls
- Pumps
- Fuel System
- Seating & Pedestals
- Trailering
- Tops & Covers
- Perform.
- Propellers
- Engine & Care
- Cleaning & Care
- Paint & Paint Acc.
- Fun & Flotation
- Topside Acc.
- Cockpit & Deck
- Hardware, Fasteners
- Camouflage
- Misc.
- Comm.

**GOLIGHT Stryker ST L.E.D. Searchlight with Wireless Handheld Remote**



- UV ray and saltwater resistant.
- 10 high flux LED's, 8° beam angle.
- 370° rotation x 135° tilt.
- 544,000 candela, max. beam distance 4,839 ft.
- New On-Command return to Home feature.
- New ability to simultaneously Pan + Tilt.
- New wireless remote control technology.
  - Smart programming logic, simple pairing without dip switches.
  - Multiple users can operate lights in close proximity without interference.
  - Multiple light selector function, allows for independent control of 2 lights with 1 remote.
- New fluorescent remote buttons.
- Stainless steel mounting bracket.
- 3.7 amps at 13.8V.
- Weather proof for land and sea applications.
- White.

Order No. Mfg. No. / Description  
**386036** (30004ST)

List Price  
**\$699.00** CO-5149500

**MAP PRICE**

**GOLIGHT Stryker ST Searchlight with Wireless Handheld Remote**



- UV ray and saltwater resistant.
- H9 65W bulb, 8° beam angle.
- 370° rotation x 135° tilt.
- 225,000 candela, max. beam distance 3,113 ft.
- New On-Command return to Home feature.
- New ability to simultaneously Pan + Tilt.
- New wireless remote control technology.
  - Smart programming logic, simple pairing without dip switches.
  - Multiple users can operate lights in close proximity without interference.
  - Multiple light selector function, allows for independent control of 2 lights with 1 remote.
- New fluorescent remote buttons.
- Stainless steel mounting bracket.
- 5.5 amps at 13.8V.
- Weather proof for land and sea applications.
- White.

Order No. Mfg. No. / Description  
**386032** (3000ST)

List Price  
**\$409.00** CO-5674300

**MAP PRICE**

**GOLIGHT GoBee Stanchion Mount Searchlight with Wireless Handheld Remote**



- UV ray and saltwater resistant.
- 360° rotation and 90° tilt.
- 80,000 candela, max. beam distance 1,857 ft.
- 5 amps at 13.8V (minimum 7 amp fuse required).
- H3 55W bulb.
- 14° beam angle.
- Integral bi-color navigation lights.
- Wireless handheld remote control.
- 12" stainless steel stanchion that fits 2 or 3 prong bow socket.
- Package includes: Wireless handheld remote, 12" stanchion with navigation lights and nylon storage bag.
- Black.

Order No. Mfg. No. / Description  
**386020** (2151)

List Price  
**\$249.00** CO-5611200

**MAP PRICE**

**GOLIGHT GT Permanent Mount Searchlights**



- UV ray and saltwater resistant.
- Wireless or hardwired remote control options.
- 370° rotation x 135° tilt.
- 225,000 candela, max. beam distance 3,113 ft.
- H9 65W bulb.
- 8° beam angle.
- Ingress protection from dust (IP56).
- High torque drive train with precise pan/tilt control.
- Stainless steel mounting bracket
- 5.5 amps at 13.8V.
- White.

**HARDWIRE DASH MOUNT REMOTE**

- Includes: 20' wiring harness with quick disconnects for easy installation.

Order No. Mfg. No. / Description  
**386015** (2020GT)

List Price  
**\$289.00** CO-5654200

**WIRELESS HANDHELD REMOTE**

Order No. Mfg. No. / Description  
**386019** (2000GT)

List Price  
**\$309.00** CO-5626200

**GOLIGHT Portable Mount Searchlight**



- Portable searchlight designed to be permanently or temporarily attached to a vehicle.
- Exclusive Cr5 Pentabeam technology.
- UV ray and saltwater resistant.
- Handheld wired remote.
- 370° rotation and 135° tilt.
- 225,000 candela, max. beam distance 3,113 ft.
- 5.5 amps. 65 watt H9 bulb.
- 8° beam angle.
- Includes: Handheld wired remote, suction cup & permanent mount shoe, 15' cord with cigarette plug for 12V DC and Rockguard lens cover.
- Charcoal.

Order No. Mfg. No. / Description  
**386021** (5149)

List Price  
**\$199.00** CO-5196100

**MAP PRICE**

**GOLIGHT Wireless Dash Mount Remote**



- Can be used alone or along with a wireless hand held remote.
- Its easily installed by removing the rubber cover and attaching four screws to the desired mounting surface.
- This remote can be used with all GT Series and old series units.

Order No. Mfg. No. / Description  
**386044** (30200)

List Price  
**\$61.09** CO-3915000

- Electronics
- Trolling Motors
- Instruments
- Electrical
- Lighting
- Anchor & Dock
- Safety
- Steering, Controls
- Pumps
- Fuel System
- Seating & Pedestals
- Trailer
- Tops & Covers
- Perform.
- Propellers
- Engine & Care
- Cleaning & Care
- Paint & Paint Acc.
- Fun & Flotation
- Topside Acc.
- Cockpit & Deck
- Hardware, Fasteners
- Camouflage
- Misc.
- Comm.

**Jabsco Secondary Remote Control Kit**



- Secondary Remote Control Kits allow searchlights to be operated from both upper and lower helm stations.
- Kit includes secondary control panel, station selector panel V-splices and butt connectors.
- Secondary Harness must be selected from Extension Harness options.
- For 7" RC, 146 SL, 255 SL.
- 12 volt.

Order No.	Mfg. No. / Description	List Price	LIMITED QUANTITIES
412508	(43670-0004)	\$527.29	GO-8235300

**Jabsco Sealed Beam for 135SL Remote Control Searchlight**



- Sealed beam - 50 watts, 100 c.p. for 135SL Remote Control Searchlight.

Order No.	Mfg. No. / Description	List Price	LIMITED QUANTITIES
413067	(18753-0178)	\$78.19	GO-9325000

**Jabsco Sealed Beam for 6" Searchlights**



- For Model 63020, 63022 Series (12/24 volt).

Order No.	Mfg. No. / Description	List Price	LIMITED QUANTITIES
413051	(64046-0006)	\$71.29	GO-6774000

**Perko Fig. 317 L.E.D. Pilot House Control Searchlight**



- Long lasting LED's, with 1/4 the energy draw of the incandescent version.
- Chrome plated brass.
- Corrosion resistant, splash proof construction.
- Lever action, pilot house control.
- Lever handle controls both horizontal and vertical movement.
- Overall length 24".
- 380° horizontal movement, 70° vertical movement.
- For ceiling thicknesses of up to 5".
- 7" searchlight head.
- Approximately range 5/8 mile.
- Tin plated electrical contacts with wiring.
- LED wattage: 25w.
- LED candlepower: 250,000.
- 12 volt.

Order No.	Mfg. No. / Description	List Price	
527929	(0317 C07 12V)	\$2,457.89	FO-2502710

**Jabsco Extension Harness**



- Extension Harnesses enable remote controls to be fitted further from the light than standard cables allow and are needed to install Secondary Remote Control Kits.
- For 135 SL, 146 SL, 155 SL (12 volt DC), 255 SL, 5" (130) and 7" (180) RC models.

Order No.	Mfg. No. / Description	List Price	LIMITED QUANTITIES
412546	(43990-0015) Length 25'	\$316.29	GO-1911200

**Perko Fig. 314 Pilot House Control Searchlights**



220462



530003

- Chrome plated brass.
- Corrosion resistant, splash proof construction.
- Tin plated electrical contacts and wiring.
- Lever action, pilot house control.
- 380° horizontal movement, 70° vertical movement.
- Lever handle controls both horizontal and vertical movement.
- Set for continuous back and forth sweep or adjust position with manual toggle controls.
- For ceiling thicknesses of up to 5".

**7" SEARCHLIGHT HEAD**

- Overall length 24".
- Candlepower: 250,000.
- Approximately range 5/8 mile.
- 100 watts.
- 12 volt.

Order No.	Mfg. No. / Description	List Price	
527917	(0314 C07 12V)	\$1,855.49	FO-4889210

**8" SEARCHLIGHT HEAD**

- Overall length 26".
- Candlepower: 500,000.
- Approximately range 3/4 mile.
- 120 watts.
- 12 volt.

Order No.	Mfg. No. / Description	List Price	
412433	(0314 C08 12V)	\$2,134.39	FO-7049410

**ACCESSORIES**

Order No.	Mfg. No. / Description	List Price	
529997	(0314 SPR 038) Handle Rod	\$48.19	FO-3733000
530003	(0314 SPR 019) Rubber Boot	\$29.59	FO-1702000
530104	(0314SPR040) Control Handle	\$34.79	DO-3872000
220462	(0433 003 12V) Replacement Bulb for 7" Head	\$108.59	FO-1067000

- Electronics
- Trolling Motors
- Instruments
- Electrical
- Lighting
- Anchor & Dock
- Safety
- Steering, Controls
- Pumps
- Fuel System
- Seating & Pedestals
- Trailing
- Tops & Covers
- Perform.
- Propellers
- Engine & Care
- Cleaning & Care
- Paint & Paint Acc.
- Fun & Flotation
- Topside Acc.
- Cockpit & Deck
- Hardware, Fasteners
- Camouflage
- Misc.
- Comm.

**Perko 800 Series Solar-Ray® Searchlights**

- Heavy gauge brass and cast bronze.
- White Perko • Kote finish.
- 12, 24, 32 or 120 volts.
- All models feature: Halo deflectors, parabolic glass mirror reflectors for maximum light output and ventilation covers for quick dissipation of heat to help prolong bulb life.
- Hinged front doors have quick release stainless steel latches.
- Weatherproof construction. Interior finished in flat black.

- Lower vent cover on 12" and 14" sizes.
- Slide-lock focusing device behind lower vent.
- Heavy duty yoke mounting.
- Standard pedestal base diameter: 7".
- 10" lights are standard with 2-pin profocus socket.
- 12" and 14" lights are standard with medium profocus socket.
- Bulbs are not included and must be ordered separately.

**Perko Fig. 885 Wheel or Lever/Gear Control Solar-Ray® Searchlights**



- Wheel Control Assemblies.
  - Turn upper wheel for horizontal position.
  - Distance between wheels: 2".
- Lever/Gear Control Assemblies.
  - Turn lower wheel for vertical position.
  - Maximum ceiling thickness: 3".
  - Aim handle for horizontal position.
  - Twist handle for vertical position.
  - Maximum ceiling thickness: 3-1/2".
- Order head and wheel or lever/gear control assemblies separately.

**STANDARD PEDESTAL HEAD ASSEMBLIES**

Order No.	Mfg. No.	Nominal Reflector	Height	List Price	
526876	(0885 OP1 WHT)	10"	20-1/8"	\$1,415.09	B0-8537210
526888	(0885 OP2 WHT)	12"	22-1/8"	\$1,866.19	B0-7597610
526890	(0885 OP3 WHT)	14"	25-1/8"	\$2,559.89	B0-0930320

**WHEEL CONTROL ASSEMBLIES**

Order No.	Mfg. No. / Description	List Price	
527208	(0852 000) Control Length 7-1/2"	\$434.29	B0-6809300
527211	(0852 0A0) Control Length 14-1/2"	\$500.39	B0-5305400
527223	(0852 0B0) Control Length 21-1/2"	\$561.09	B0-8940500
527234	(0852 0C0) Control Length 28-1/2"	\$635.39	B0-5817500

**LEVER/GEAR CONTROL ASSEMBLY**

Order No.	Mfg. No. / Description	List Price	
527247	(0969 0C0) Control Length 29-1/2"	\$1,391.49	B0-4325210

**Perko Spare Reflector for 800 Series Solar-Ray® Searchlights**



- Replacement Retaining Clips (530178 - 0910) for the reflector should also be ordered when ordering a replacement reflector to assure a proper fit.

Order No.	Mfg. No. / Description	List Price	
543202	(0890001) Spare Reflector for 10" Searchlights	\$522.49	B0-4207400
543214	(0890002) Spare Reflector for 12" Searchlights	\$556.19	B0-7500500
543226	(0890003) Spare Reflector for 14" Searchlights	\$1,220.59	B0-3589010
530178	(0910) Spare Retaining Clips	\$47.59	B0-3824000

See next page for spare sockets and bulbs for Perko 800 Series Solar-Ray® Searchlights

**Perko Fig. 884 Lever Control Solar-Ray® Searchlights**



- Aim handle for horizontal position.
- Move handle up and down for vertical position.
- Maximum ceiling thickness: 4-1/2".
- Order head and lever control assemblies separately.

**STANDARD PEDESTAL HEAD ASSEMBLIES**

Order No.	Mfg. No.	Nominal Reflector	Height	List Price	
526838	(0884 OP1 WHT)	10"	20-1/8"	\$1,483.89	B0-0553310
526840	(0884 OP2 WHT)	12"	22-1/8"	\$1,935.09	B0-8514710
526852	(0884 OP3 WHT)	14"	25-1/8"	\$2,565.39	B0-5880320

**LEVER CONTROL ASSEMBLIES**

Order No.	Mfg. No. / Description	List Price	
527108	(0851 000) Control Length 8-1/2"	\$365.59	B0-3092300
527119	(0851 0A0) Control Length 15-1/2"	\$434.29	B0-6809300
527121	(0851 0B0) Control Length 22-1/2"	\$500.39	B0-5305400
527132	(0851 0C0) Control Length 29-1/2"	\$561.09	B0-8940500

**SPARE PARTS FOR FIG. 851 LEVER CONTROL ASSEMBLY**

Order No.	Mfg. No. / Description	List Price	
530015	(0851SPR021) Horizontal Lock/Ceiling Plate	\$117.69	D0-5149000
530027	(0851SPR022) Lock Knob with Spacer	\$28.39	D0-1722000
530053	(0851SPR025) Upper Control Tube Bushing	\$24.89	D0-1991000
530077	(0851SPR027) O-Ring Seal	\$17.19	D0-5731000
530089	(0851SPR028) Lower Control Tube Bushing	\$24.89	D0-1991000
530091	(0851SPR029) Control Handle Shaft	\$33.99	D0-9172000
530104	(0314SPR040) Control Handle	\$34.79	D0-3872000
530116	(0851SPR031) Fulcrum Collar	\$33.99	D0-9172000
530128	(0851SPR032) Fulcrum Bar	\$29.79	D0-3832000
530142	(0884SPR055) Fork Seal Bushing	\$25.99	D0-9702000
530154	(0884SPR056) Base Seal	\$31.59	D0-7252000

**Perko Fig. 887 Distant Electric Control Solar-Ray® Searchlights**



- All aluminum with White Perko • Kote finish.
- For 12, 24 and 120 volt.
- Searchlight head assembly comes with Distant Electric Control Base.
- Remote electric.
- Joystick type controller with variable speed control for both horizontal and vertical positioning.
- Nominal drum diameter: 14". Length drum: 17".

CALL FOR PRICES AND AVAILABILITY



**SPECIAL HANDLING MAY APPLY**



- Electronics
- Trolling Motors
- Instruments
- Electrical
- Lighting
- Anchor & Dock
- Safety
- Steering, Controls
- Pumps
- Fuel System
- Seating & Pedestals
- Trailer
- Tops & Covers
- Perform.
- Propellers
- Engine & Care
- Cleaning & Care
- Paint & Paint Acc.
- Fun & Flotation
- Topside Acc.
- Cockpit & Deck
- Hardware, Fasteners
- Camouflage
- Misc.
- Comm.



**Bulb and Socket Ordering Information for Perko 800 Series Solar-Ray® Searchlights**

- Bulbs are not included in lights and must be ordered separately.
- For best results, the bulb and reflector must be perfectly compatible; therefore be sure to specify the stock number of the bulb desired.
- Peak candlepower is exceedingly sensitive to many factors, (i.e. a light source out of focus by 1/32 inch, under-voltage of only 4% or differences between bulb manufactures) which can cause reduction of range of up to 20%.

**Incandescent Bulb Recommendations**

MFG #	Voltage	Wattage	Socket Type	Socket Code Letter	For Searchlight Size	Rated* Life Hours	Mfg. Bulb Code
806	32	500	Medium Screw	B	10", 12", 14"	50	DLT
807	120	500	Medium Prefocus	E	10", 12", 14"	25	CZX/DAB
809	120	750	Medium Prefocus	E	12", 14"	25	DDB
837	120	750	Medium Prefocus	E	12", 14"	200	DGH
810	120	1,000	Medium Prefocus	E	12", 14"	25	DRS
811	120	1,000	Mogul Screw	D	12", 14"	50	DPT

**"Quartz" Tungsten Halogen Bulb Recommendations**

DMI #	MFG #	Voltage	Wattage	Socket Type	Socket Code Letter	For Searchlight Size	Rated* Life Hours	Mfg. Bulb Code
<b>220070</b>	816	12	100	2-Pin Prefocus	F	10", 12", 14"	50	FDT
	836	24	150	2-Pin Prefocus	G	10", 12", 14"	50	DZE/FDS
<b>219825</b>	844	120	500	Medium Prefocus	E	10", 12", 14"	500	BTM
<b>220020</b>	820	120	600	2-Pin Prefocus	I	10", 12", 14"	75	DYS
<b>219837</b>	845	120	750	Medium Prefocus	E	12", 14", 19"	200	BTP
<b>219851</b>	839	120	900	2-Pin Prefocus	K	12", 14", 19"	75	BVA
<b>219849</b>	846	120	1,000	Medium Prefocus	E	12", 14", 19"	200	BTR
	860	230	1,000	Medium Prefocus	E	12", 14", 19"	950	FKD

• Electric bulbs are not returnable unless the fault is ours.

\*Note: These are the "Rated Average Laboratory Life in Hours" of the Bulb Manufacturer. No guarantee to the time indicated.

**High Pressure Xenon Short Arc Lamp**

Order No. **696316** Mfg. No. / Description (XW1000/M)

List Price **\$598.98** E0-4294400

- Power input: Rated 1,000W.
- Supply voltage: 65 volts.
- Operating current: 50 amp.

- Rated voltage: 20 volts.
- Luminous flux: 32,000 lm.

**Electric Socket and Support Stand Assemblies**

- Perko Solar-Ray Searchlights include a socket and support stand based on the bulb or socket information given when ordering.
- The following chart makes it possible for distributors or dealers to order and stock different styles of these assemblies separately for field conversion, thereby covering a large variety of voltage and candlepower requirements with a minimum of inventory. (Donovan numbers are bold).



Medium Screw Code B



Medium Prefocus Code E



Mogul Screw Code D



Mogul Prefocus Code L and M

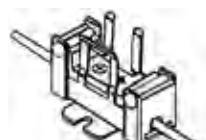

2-Pin Prefocus Code K

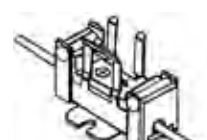

2-Pin Prefocus Code F, G, H and I

Socket Type	Socket Code	For 10" Searchlights	Height Stand	For 12" Searchlights	Height Stand	For 14" Searchlights	Height Stand
Medium Screw	B	872 001	1-1/4"	872 002	2-1/4"	872 003	3-1/4"
Medium Prefocus	E	<b>530332</b> (873 001)	1-5/16"	<b>530344</b> (873 002)	1-15/16"	<b>530356</b> (873 003)	2-15/16"
Mogul Screw	D	-	-	874 002	7/16"	874 003	1-1/4"
2-Pin Prefocus (12 volt)	F	875 001	3-1/2"	875 002	4-1/2"	875 003	5-1/2"
2-Pin Prefocus (24 volt)	G	876 001	3-1/4"	876 002	4-1/4"	876 003	5-1/4"
2-Pin Prefocus (32 volt)	H	878 001	3-1/4"	878 002	4-1/4"	878 003	5-1/4"
2-Pin Prefocus (600 watt)	I	<b>530421</b> (879 001)	3-1/8"	879 002	4-1/8"	879 003	5-1/8"
2-Pin Prefocus (900 watt)	K	-	-	880 002	3-13/16"	880 003	4-13/16"

Order No. **530469** (0895) Medium Prefocus Socket Code E List Price **\$145.09** B0-8503100  
**530483** (0899) 2-Pin Prefocus Socket Codes F, G, H & I List Price **\$124.89** B0-0421100

Order No. **530332** (0873 001) For 10" Searchlights List Price **\$228.99** B0-9060200  
**530344** (0873 002) For 12" Searchlights List Price **\$228.99** B0-9060200  
**530356** (0873 003) For 14" Searchlights List Price **\$228.99** B0-9060200  
**530421** (0879 001) 2-Pin Prefocus for 10" Searchlights List Price **\$268.89** B0-0024200

- Electronics
- Trolling Motors
- Instruments
- Electrical
- Lighting
- Anchor & Dock
- Safety
- Steering, Controls
- Pumps
- Fuel System
- Seating & Pedestals
- Trailing
- Tops & Covers
- Perform.
- Propellers
- Engine & Care
- Cleaning & Care
- Paint & Paint Acc.
- Fun & Flotation
- Topside Acc.
- Cockpit & Deck
- Hardware, Fasteners
- Camouflage
- Misc.
- Comm.

**Perko XR Series 15" Xenon Searchlights**

- Designed and manufactured to meet the demanding needs of commercial marine applications.
- The short arc Xenon filled lamps produce an extremely bright and very white light which can be focused in the pilothouse into a narrow long range beam.
- High quality Timkin bearings provide for smooth 380° rotation.
- The XR Series model 9304 searchlight can be operated continuously at 500 watts for a maximum brightness of 35,000,000 candlepower and over 3 mile (IES Handbook) range.
- An iridium coated precision reflector provides for maximum light output and sharp focus.
- The remote control panel controls lamp ignition (start-up) and focus from the pilot house.
- Superior cooling is provided by a heavy duty cooling fan which blows air across the lamp inside the sealed housing.
- Heavy duty marine latches.
- Sealed waterproof construction.
- Heavy rolled marine aluminum housing.
- Safety interlock switch.
- Heavy duty rack and pinion assembly.
- Cast marine aluminum yoke and base.
- Quality ball bearings.
- Nominal drum diameter: 13-3/4".
- 120 VAC.
- NOTE: Lamps are included with complete Searchlights.



Order No.	Mfg. No. / Description	List Price
544050	(9304E01WH5) Distant Electric Control Base	\$20,304.39

**Perko 19" Solar-Ray® Searchlight and Control Assemblies**

- Halo deflector.
- Heavy gauge reinforced aluminum body.
- White Perko - Kote finish.
- 19" parabolic glass reflector with shock resistant mounting.
- Weatherproof construction.
- Flat black interior finish.
- Stainless steel latches.
- Lower vent cover.
- Slide-lock focusing device behind lower vent.
- Heavy duty cast rack and pinion assembly.
- Extra heavy duty yoke mounting ribbed for extra strength.
- Floating stops in base to allow 400° rotation.
- Bushing and rubber gasket for isolated mounting.
- Extra large cast aluminum base drilled for (4) 1/2" fasteners.

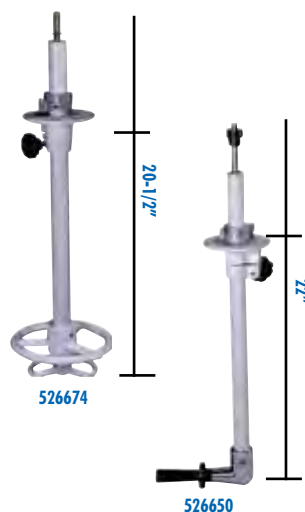

**ELECTRIC SOCKET AND SUPPORT STAND ASSEMBLIES FOR 19" SEARCHLIGHTS**

Solar-Ray Searchlights include a socket and support stand based on the bulb or socket information given when ordering. The following chart makes it possible to order and stock different assemblies for field conversion, to meet a large variety of voltage and candlepower requirements with a minimum of inventory.

Socket Type	Socket Code	Socket & Stand Catalog Number	Height Stand	Order No.	Mfg. No. / Description	List Price
Medium Screw	B	0872 004	5-3/4"	526600	(1902 004 WHT) Searchlight Head Assembly	\$2,541.69
Medium Prefocus	E	0873 004	5-7/16"	526650	(1921 000 WHT) Lever/Gear Control Assembly	\$1,561.69
Mogul Prefocus (1,500 watt)	L	1930 004	3-5/8"	526674	(1922 000 WHT) Wheel Control Assembly	\$1,595.69
Mogul Prefocus (1,000 & 2,000 watt)	M	1931 004	3-1/8"	543238	(0890004) Spare Reflector	\$1,804.79
2-Pin Prefocus (900 watt)	K	0880 004	7-5/16"	530229	(0905) Spare Pinion Gear	\$139.69

**How to Order Searchlights**

- Specify size searchlight, type control, type base, type drum, type finish, type lampholder, and give code word or catalog number.
- Give ordering code and volts of lamp.
- Specify length of control (measured from bottom of base to centerline of lever or upper wheel) if other than the standard dimensions shown on the dimension drawings.
- Specify pedestal height (measured from bottom of base to centerline of drum) if different from the standard 48 inches.
- Example: 12" searchlights, lever control, standard base, vented drum, enamel finish, medium prefocus lampholder, code RECITE-E2. Special length control 22" base to centerline lever.
- To designate the specific lampholder desired add one of the following suffixes to the code word or catalog number:

Medium Screw Lampholder -1 Medium Prefocus Lampholder -2 Mogul Screw Lampholder -3 Mogul Bipost Lampholder -4 2-Pin Prefocus Lampholder -5

**SPECIAL HANDLING MAY APPLY**

- Electronics
- Trolling Motors
- Instruments
- Electrical
- Lighting
- Anchor & Dock
- Safety
- Steering, Controls
- Pumps
- Fuel System
- Seating & Pedestals
- Trailering
- Tops & Covers
- Perform.
- Propellers
- Engine & Care
- Cleaning & Care
- Paint & Paint Acc.
- Fun & Flotation
- Topside Acc.
- Cockpit & Deck
- Hardware, Fasteners
- Camouflage
- Misc.
- Comm.

The Carlisle & Finch Co. 500 Watt Xenon Arc Searchlights



Distant Electrical Control



Lever Gear Control



275441

LEVER GEAR CONTROL - DRUM-SIZE NOMINAL 15"

- This powerful, rugged design, composed of marine grade aluminum and stainless steel, with high quality salt and scratch resistant powder coat finish.
- The indestructible, nickel reflector produces a precision 1-Degree beam at a powerful 45 million beam candlepower.
- The searchlight focus has safety back-up, with no tools required (if the Focus Motor fails, the beam-size can be adjusted quickly and easily, with an external focus knob).
- The searchlight is mounted on a rugged base producing greater than 385 degrees of horizontal rotation with unique sliding stop.
- Remote electric beam-size focus (1 to 15 degrees).
- Voltages: 12VDC, 24VDC, 115VAC, 230VAC.
- Long-life warranted xenon lamp.

Order No.	Mfg. No. / Description	List Price	
275304	(X9396LG-RF) Head with 70" Lever Gear Control	\$11,862.00	A0-0026811
274302	(C2-4) Control Station	\$545.00	A0-0054500

DISTANT ELECTRIC CONTROL

- These units have all the features listed above and also the following.
- "Proportional-Speed" joystick provides aiming and speed control with single-hand.
- Motorized rugged cast base with horizontal and vertical clutch assemblies and ball bearings contained in stainless steel races.
- Fast speed searches at 25 degrees per second.
- Single station or multiple stations.
- Indoor and outdoor weatherproof control stations.
- Optional anti-icing heater circuitry in base, rack and trunnions, digital azimuth indicator, manual back-up (in case of motor failure).

Order No.	Mfg. No. / Description	List Price	
275435	(X9398-RF) Joystick Electric Controller	\$14,720.00	A0-0002741
275441	(C4-1M-1) Joystick Controller - 4-Way Switch	\$1,150.00	A0-0005110
274934	(6PSN115) Power Supply - Manual Control - 115V AC	\$4,505.00	A0-0050540
275439	(6PSN115DE) Power Supply - Remote Control - 115V AC	\$5,585.00	A0-0058550

The Carlisle & Finch Co. 1,000 Watt and 2,500 Watt Xenon Arc Searchlights



"Wall of Light" LED's



LEVER GEAR CONTROL - DRUM-SIZE NOMINAL 19"

- This powerful, rugged design, composed of marine grade aluminum and stainless steel, with a high quality salt and scratch resistant powder coat finish.
- The indestructible, nickel reflector produces a precision 1-Degree beam at a powerful 80 million (1.0kw) and 177 million (2.5kw) beam candlepower.
- The searchlight focus has safety back-up, with no tools required (if the Focus Motor fails, the beam-size can be adjusted quickly and easily, with an external focus knob).
- The searchlight is mounted on a rugged base, which includes ball bearings held captive within stainless steel races, producing greater than 385 degrees of horizontal rotation with unique sliding stop.
- Remote electric beam-size focus (approx. 1 to 15 degrees).
- Voltages: Single phase 115VAC, 230VAC and 3-phase 208/240 VAC, 380 VAC, 480 VAC or 575 VAC.
- Long-life warranted xenon lamp.

Order No.	Mfg. No. / Description	List Price	
275417	(XE9664LG-RF) Head w/46" Lever Gear Control	\$15,584.00	A0-0048551
275431	(9754X-RF) Control Station	\$625.00	A0-0052600

DISTANT ELECTRIC CONTROL

- Motorized rugged cast base with horizontal and vertical clutch.
- Assemblies and ball bearings contained in stainless steel races.
- Exceeds 380 degrees horizontal rotation.
- 8-position joystick provides vertical and horizontal movement.
- Speed control dial changes beam speed from 0 to 25 degrees per second.
- Single station or multiple stations.
- Indoor and outdoor weatherproof control stations.
- Optional anti-icing heater circuitry in base, rack and trunnions.
- Optional digital azimuth indicator.
- Optional manual back-up (in case of motor failure).

Order No.	Mfg. No. / Description	List Price	
275445	(XE9666-RF) Joystick Electric Controller	\$17,240.00	A0-0004271
275455	(C4-1M-2) Joystick Controller - 4-Way Switch	\$1,175.00	A0-0057110
275430	(1PSN115) Power Supply - Manual Control - 115V AC	\$6,675.00	A0-0057660
275450	(1PSN115DE) Power Supply - Remote Control - 115V AC	\$7,860.00	A0-0006870

SPECIAL HANDLING MAY APPLY



- Electronics
- Trolling Motors
- Instruments
- Electrical
- Lighting
- Anchor & Dock
- Safety
- Steering, Controls
- Pumps
- Fuel System
- Seating & Pedestals
- Trailering
- Tops & Covers
- Perform.
- Propellers
- Engine & Care
- Cleaning & Care
- Paint & Paint Acc.
- Fun & Flotation
- Topside Acc.
- Cockpit & Deck
- Hardware, Fasteners
- Camouflage
- Misc.
- Comm.

**Carlisle & Finch Co. Halogen Searchlights Beam Candlepowers**

Code	Watts	Volts	Base	Average Hrs.	10-Inch	12-Inch	15-Inch	19-Inch
CPG	108	6	Medium Screw	50	350,000	563,000	Not Used	Not Used
FDT	100	12	2-Pin Pre-focus	50	765,000	1,170,000	1,750,000	Not Used
FDS	150	24	2-Pin Pre-focus	100	935,000	1,380,000	2,030,000	Not Used
BTM	500	120	Medium Pre-focus	100	950,000	1,160,000	2,080,000	2,970,000
FKF	500	230	Medium Pre-focus	750	<b>CONSULT FACTORY</b>			
DYS	600	120	2-Pin Pre-focus	75	781,000	1,130,000	1,840,000	2,700,000
BTP	750	120	Medium Pre-focus	200	Not Used	1,520,000	2,820,000	3,980,000
BVA	900	120	2-Pin Pre-focus	75	<b>CONSULT FACTORY</b>			
BTR	1000	120	Medium Pre-focus	200	Not Used	1,520,000	2,820,000	4,300,000
1M/T20	1000	120	Mogul Bi-Post	500	Not Used	Not Used	940,000	2,380,000
DPT	1000	120	Mogul Screw	50	Not Used	Not Used	Not Used	2,700,000
FKD	1000	230	Medium Pre-focus	750	Not Used	Not Used	Not Used	1,800,000
CXZ	1500	120	Mogul Bi-Post	325	Not Used	Not Used	Not Used	
CWZ	1500	120	Mogul Pre-focus	325	Not Used	Not Used	Not Used	3,610,000
BVW	2000	120	Mogul Pre-focus	300	Not Used	Not Used	Not Used	3,000,000
FKK	2000	230	Mogul Bi-Post	400	Not Used	Not Used	Not Used	



**The Carlisle & Finch Co. Halogen Searchlight Selection Table**

**10" HALOGEN SEARCHLIGHT**

Type Control	Type Base	Type Drum	Powder Coat Finish	Net Wt.	Shipping Wt.	Type Control	Type Base	Type Drum	Powder Coat Finish	Net Wt.	Shipping Wt.
Local	Standard	Non Vented	RAIN-E	15 lbs.	21 lbs.	Lever-Gear	Standard	Non Vented	10SL8425E	22 lbs.	28 lbs.
	High	Non Vented	ROSE-E	22 lbs.	28 lbs.		High	Non Vented	10SL8426E	30 lbs.	36 lbs.
	Pedestal	Non Vented	RAJAH-E	29 lbs.	59 lbs.		Pedestal	Non Vented	10SL8427E	37 lbs.	58 lbs.
Lever	Standard	Non Vented	REDAN-E	19 lbs.	25 lbs.	Wheel	Standard	Non Vented	RANK-E	19 lbs.	25 lbs.
	High	Non Vented	REFORM-E	27 lbs.	33 lbs.		High	Non Vented	ROPE-E	27 lbs.	33 lbs.
	Pedestal	Non Vented	10SL1624XE	34 lbs.	55 lbs.		Pedestal	Non Vented	10SL1620XE	37 lbs.	55 lbs.

**12" HALOGEN SEARCHLIGHT**

Type Control	Type Base	Type Drum	Powder Coat Finish	Net Wt.	Shipping Wt.
Local	Standard	Non Vented	RAKE-E	22 lbs.	31 lbs.
		Vented	RATE-E	22 lbs.	31 lbs.
	High	Non Vented	ROME-E	27 lbs.	36 lbs.
		Vented	RUN-E	27 lbs.	36 lbs.
	Pedestal	Non Vented	RETARD-E	34 lbs.	64 lbs.
		Vented	12SL1648XE	34 lbs.	64 lbs.
Lever	Standard	Non Vented	REDEEM-E	26 lbs.	35 lbs.
		Vented	RECITE-E	26 lbs.	35 lbs.
	High	Non Vented	REFUGE-E	32 lbs.	41 lbs.
		Vented	RESIN-E	32 lbs.	41 lbs.
	Pedestal	Non Vented	12SL1625XE	39 lbs.	60 lbs.
		Vented	12SL1650XE	39 lbs.	60 lbs.
Lever-Gear	Standard	Non Vented	12SL8186E	29 lbs.	38 lbs.
		Vented	12SL8186VE	29 lbs.	38 lbs.
	High	Non Vented	12SL8410E	35 lbs.	44 lbs.
		Vented	12SL8410VE	35 lbs.	44 lbs.
	Pedestal	Non Vented	12SL8428E	42 lbs.	63 lbs.
		Vented	12SL8428VE	42 lbs.	63 lbs.
Wheel	Standard	Non Vented	RASP-E	26 lbs.	35 lbs.
		Vented	REAR-E	26 lbs.	35 lbs.
	High	Non Vented	RUSE-E	32 lbs.	41 lbs.
		Vented	RIPE-E	32 lbs.	41 lbs.
	Pedestal	Non Vented	12SL1621XE	39 lbs.	60 lbs.
		Vented	12SL1649XE	39 lbs.	60 lbs.

**15" HALOGEN SEARCHLIGHT**

Type Control	Type Base	Type Drum	Powder Coat Finish	Net Wt.	Shipping Wt.
Local	Standard	Non Vented	REDGUM-E	39 lbs.	51 lbs.
		Vented	REDGUM-VE	39 lbs.	51 lbs.
	High	Non Vented	REEL-E	44 lbs.	56 lbs.
		Vented	REEL-VE	44 lbs.	56 lbs.
	Pedestal	Non Vented	RONTY-E	50 lbs.	80 lbs.
		Vented	RONTY-VE	50 lbs.	80 lbs.
Lever	Standard	Non Vented	RADIAL-E	43 lbs.	55 lbs.
		Vented	RADIAL-VE	43 lbs.	55 lbs.
	High	Non Vented	RAINBOW-E	49 lbs.	61 lbs.
		Vented	RAINBOW-VE	49 lbs.	61 lbs.
	Pedestal	Non Vented	15SL1626XE	56 lbs.	77 lbs.
		Vented	15SL1626XVE	56 lbs.	77 lbs.
Lever-Gear	Standard	Non Vented	15SL8184E	46 lbs.	58 lbs.
		Vented	15SL8184VE	46 lbs.	58 lbs.
	High	Non Vented	15SL8408E	52 lbs.	64 lbs.
		Vented	15SL8408VE	52 lbs.	64 lbs.
	Pedestal	Non Vented	15SL8429E	59 lbs.	80 lbs.
		Vented	15SL8429VE	59 lbs.	80 lbs.
Wheel	Standard	Non Vented	RACKET-E	43 lbs.	55 lbs.
		Vented	RACKET-VE	43 lbs.	55 lbs.
	High	Non Vented	RABBIT-E	49 lbs.	61 lbs.
		Vented	RABBIT-VE	49 lbs.	61 lbs.
	Pedestal	Non Vented	15SL1622XE	56 lbs.	77 lbs.
		Vented	15SL1622XVE	56 lbs.	77 lbs.

Note: Consult Factory for Polished Brass & Stainless Steel or Sparking Chrome and Stainless Steel Finish.

- Electronics
- Trolling Motors
- Instruments
- Electrical
- Lighting
- Anchor & Dock
- Safety
- Steering, Controls
- Pumps
- Fuel System
- Seating & Pedestals
- Trailering
- Tops & Covers
- Perform.
- Propellers
- Engine & Care
- Cleaning & Care
- Paint & Paint Acc.
- Fun & Flotation
- Topside Acc.
- Cockpit & Deck
- Hardware, Fasteners
- Camouflage
- Misc.
- Comm.



**SPECIAL HANDLING MAY APPLY**



The Carlisle & Finch Co. Halogen Searchlights



LEVER CONTROL

Size	Control Length
10"	11-3/8"
12"	10-7/8"
15"	10-7/8"

LEVER-GEAR CONTROL

Size	Control Length
10"	11-3/8"
12"	10-7/8"
15"	10-7/8"

WHEEL CONTROL

Size	Control Length
10"	9-1/2"
12"	9"
15"	9"

- Electronics
- Trolling Motors
- Instruments
- Electrical
- Lighting
- Anchor & Dock
- Safety
- Steering, Controls
- Pumps
- Fuel System
- Seating & Pedestals
- Trailing
- Tops & Covers
- Perform.
- Propellers
- Engine & Care
- Cleaning & Care
- Paint & Paint Acc.
- Fun & Flotation
- Topside Acc.
- Cockpit & Deck
- Hardware, Fasteners
- Camouflage
- Misc.
- Comm.

The Carlisle & Finch Co. 10" Searchlight with 2-Pin Prefocus Socket

- Lever control.
- 18" longer than standard.
- Powder coat, brass and stainless steel finishes available.

Order No.	Mfg. No. / Description	List Price
274489	(REDAN-E5)	\$2,887.00

SPARE REFLECTOR FOR 10" SEARCHLIGHT

Order No.	Mfg. No. / Description	List Price
273831	(SL1083A) Diameter 9"	\$565.00

The Carlisle & Finch Co. 19" Searchlight with Medium Prefocus Socket

- Powder coat marine grade aluminum drum finish available.

LEVER GEAR CONTROL

Order No.	Mfg. No. / Description	List Price
274782	(19SL3794DX) 48" Longer than Standard	\$5,697.00

SPARE PARTS FOR 19" SEARCHLIGHT

Order No.	Mfg. No. / Description	List Price
273754	(KEF217) Pinion Gear, Wheel/Lever Gear Control	\$70.00
273526	(EF240) Reflector, Diameter 18-1/8"	\$1,320.00
273970	(SL1461/SL1455) Reflector Clamp Assembly 19"	\$31.39

Spare Parts for 10", 12" and 15" Searchlights

Order No.	Mfg. No. / Description	List Price
274047	(K5482) Pinion Gear for Wheel Control	\$70.00
273969	(SL1937) Reflector Mounting Clips - 4 Per Light	\$10.00
273526	(8704) 2-Pin Prefocus Socket Only	\$45.00
273918	(SL1250C) Medium Prefocus Socket Only	\$95.00
273843	(SL1084) 15" Reflector - Dia. 14-3/16"	\$1,145.00

The Carlisle & Finch Co. 12" Searchlight with Medium Prefocus Socket

- Powder coat, brass and stainless steel finishes available - vented drum.

WHEEL CONTROL

Order No.	Mfg. No. / Description	List Price
274605	(REAR-E2.) 24" Longer than Standard	\$3,896.00

SPARE PARTS FOR 12" SEARCHLIGHT

Order No.	Mfg. No. / Description	List Price
273690	(9865XV) Medium Prefocus Focus Assembly	\$300.00
273829	(SL107) Reflector, Diameter 10-15/16"	\$625.00

Accessories and Parts

Description	10" Sckt. Part #	12" Sckt. Part #	15" Sckt. Part #
Cover, Protective	SL3322A	SL3322A	SL3322B
Cover Glass	SL62	SL102	SL1085
Gasket, Base, High	SL3318B	SL3318B	SL3318B
Gasket, Base, Pedestal	SL3318C	SL3318C	SL3318C
Gasket, Base, Standard	SL3318A	SL3318B	SL3318B
Lampholder, Med. Pref. (273918)	SL1250C	SL1250C	SL1250C
Lampholder, Med. Screw	SL1087-1	SL1087-1	SL1087-1
Lampholder, Mogul Bipost	-	-	FE132X
Lampholder, Mogul Screw (274302)	-	SL96	SL96
Lampholder, 2-Pin Pref. (273526)	8704	8704	8704
Reflector	SL1083A (273831)	SL107 (273829)	SL1084 (273843)

The Carlisle & Finch Co. Accessories and Parts

Order No.	Mfg. No. / Description
273971	(SL1461) Fixed Spring
273972	(SL1455) Clamp Spring
274958	(8672XS) Control Assembly
274959	(4799X-RFS) Control Station

SPECIAL HANDLING MAY APPLY



The Carlisle & Finch Co. Halogen Searchlights - Searchlight Lamp Data

SEARCHLIGHT LAMP DATA

DMI #	Code	Watts	Volts	Bulb Size	Base	Description	Filament	Average Hrs. Life	10" Scht.	12" Scht.	15" Scht.
220070	FDT	100	12	T4	2-Pin Prefocus	Tungsten Halogen	C6	50	765,000	1,170,000	1,750,000
	FDS	150	24	T4	2-Pin Prefocus	Tungsten Halogen	C6	100	935,000	1,380,000	2,030,000
					Medium Screw						
219825	BTM	500	120	T6	Medium Prefocus	Tungsten Halogen	C13D	100	950,000	1,160,000	2,080,000
220020	DYS	600	120	G7	2-Pin Prefocus	Tungsten Halogen	CC6	75	**781,000	1,130,000	1,840,000
					Medium Screw						

LAMP BELOW TO BE USED IN VENTED DRUMS ONLY

DMI #	Code	Watts	Volts	Bulb Size	Base	Description	Filament	Average Hrs. Life	10" Scht.	12" Scht.	15" Scht.
219849	BTR	1,000	120	T7	Medium Prefocus	Tungsten Halogen	C13D	200	Not Used	1,520,000	2,820,000

\* These lamp manufacturer's figures are relative only. Individual lamps may vary considerably. \*\* Intermittent duty only (one hour or less).

The Carlisle & Finch Co. L.E.D. and WindFarm Searchlights



12L-LC-ANC  
12"



12LHW-DE-ANC  
12"



274785  
19LN-LG-ANC  
19"



19L-LC-ANC

10" L.E.D. SEARCHLIGHT

Type Control	Type Base	Powder Coat Finish	Voltage	Remarks
Local	Standard	10L-LC-DNC	12-24 VDC	Specify Joystick C8160 (115VAC) or C8160-230 (230VAC)
	Standard	10L-LC-ANC	115-230 VAC	
Lever Gear	Standard	10L-LG-DNC	12-24 VDC	
	Standard	10L-LG-ANC	115-230 VAC	
Joystick Electric	Standard	10L-DE-ANC	115-230 VAC	

12" L.E.D. SEARCHLIGHT

Type Control	Type Base	Powder Coat Finish	Voltage	Remarks
Local	Standard	12L-LC-DNC	12-24 VDC	Specify Joystick C8160 (115VAC) or C8160-230 (230VAC)
	Standard	12L-LC-ANC	115-230 VAC	
Lever Gear	Standard	12L-LG-DNC	12-24 VDC	
	Standard	12L-LG-ANC	115-230 VAC	
Joystick Electric	Standard	12L-DE-ANC	115-230 VAC	

12" L.E.D. WINDFARM SEARCHLIGHT

Type Control	Type Base	Powder Coat Finish	Voltage	Remarks
Joystick Electric	N/A	12LHW-DE-ANC	115-230 VAC	Specify Joystick C8160 (115VAC) or C8160-230 (230VAC); must also include Controller C2-13 for both voltages

19" L.E.D. SEARCHLIGHT

Type Control	Type Base	Powder Coat Finish	Voltage	Remarks
Local	Standard	19L-LC-ANC	115-230 VAC	Specify Joystick C5777-S-2 (115VAC) or C5777-S-230 (230VAC)
Lever Gear	Standard	274785 (19L-LG-ANC)	115-230 VAC	
Joystick Electric	Standard	19L-DE-ANC	115-230 VAC	
Head Only	Standard	19L-DD-ANC	115-230 VAC	Includes Trunnion Hardware & Cable, Electric Control
Head Only	Standard	19L-MD-ANC	115-230 VAC	Includes Trunnion Hardware & Cable, Manual Control
		274783 (19L-UD-ANC)		

- Electronics
- Trolling Motors
- Instruments
- Electrical
- Lighting**
- Anchor & Dock
- Safety
- Steering, Controls
- Pumps
- Fuel System
- Seating & Pedestals
- Trailering
- Tops & Covers
- Perform.
- Propellers
- Engine & Care
- Cleaning & Care
- Paint & Paint Acc.
- Fun & Flotation
- Topside Acc.
- Cockpit & Deck
- Hardware, Fasteners
- Camouflage
- Misc.
- Comm.



**SPECIAL HANDLING MAY APPLY**



Electronics

Trolling Motors

Instruments

Electrical

Lighting

Anchor & Dock

Safety

Steering, Controls

Pumps

Fuel System

Seating & Pedestals

Trailer

Tops & Covers

Perform.

Propellers

Engine & Care

Cleaning & Care

Paint & Paint Acc.

Fun & Flotation

Topside Acc.

Cockpit & Deck

Hardware, Fasteners

Camouflage

Misc.

Comm.

The Carlisle & Finch Co. 12" Searchlights - Distant Electric Control (DEC)

- Base is brass.
- Drum, door and yoke, etc., constructed of solid brass.
- Powerful motors in weatherproof base direct the penetrating beam with finger-tip ease from any distance.
- Automatic brakes provide instant start and instant stop with no overtravel.
- Searchlight can be controlled from many separate locations.
- Vented drum (non-vented also available).
- Motors operate on 110-125 volts, 50-60 hz (cycles).
- Rugged joystick switch controls both motions.
- No limit to distance between searchlight and joystick.
- Second, third, fourth, or more joysticks can be added at any time.
- Just five control conductors and a ground conductor required between searchlight and joystick.
- Slip clutches allow manual override at all times, a convenience when relamping.
- Corrosion resistant and oiltight, the joystick can be mounted almost anywhere.
- A small heater on drive unit keeps temperature in base housing above ambient to minimize condensation on and in motors.
- Includes medium prefocus lampholder.
- Bullet lamp not included.
- Includes: 12" electric control.



Order No. **274908** Mfg. No. / Description (125BEV-2) List Price **\$6,325.00** BO-0529650

AVAILABLE IN 10", 12" AND 15" PRICE ON REQUEST

Medium Screw Bulbs - Low Voltage



- Priced each, sold in packs of 4.

Order No.	Mfg. No. / Description	List Price
<b>220195</b>	(103C) 12 volt 25 watt Frost	<b>\$8.39</b> H0-3050000
<b>220234</b>	(0203X) 12 volt 50 watt Frost	<b>\$6.69</b> B0-2060000
<b>220208</b>	(1626A) 24 volt 25 watt Frost	<b>\$6.69</b> B0-2060000
<b>220210</b>	(01551C) 34 volt 25 watt Frost	<b>\$16.19</b> H0-1790000
<b>220258</b>	(0204K) 34 volt 50 watt Frost	<b>\$6.59</b> B0-3950000

Medium Frost Screw Bulb



Order No.	Mfg. No. / Description	List Price
<b>569244</b>	(0114P) 120 volt 60 watt	<b>\$3.99</b> B0-9530000

Miniature Screw Bulbs



- Base Type: E10.
- Bulb Shape: G4 1/2.
- Price each. Standard pack 10.

Order No.	Mfg. No. / Description	List Price
<b>569206</b>	(182085) 502 5.1 volt .765 watt .15 amp	<b>\$0.99</b> B0-9800000
<b>219509</b>	(4187B) 407 4.9 volt .3 amp	<b>\$4.49</b> B0-4040000

Blue Bulb



- Blue.
- 130 volt, 7.5 watt.

Order No.	Mfg. No. / Description	List Price
<b>569304</b>	(00037C)	<b>\$2.98</b> L0-9410000

Miniature Bayonet Base Bulbs



7-4000



7-3905



7-3910



219724

SIZE 53

- 14.4 volts. 1.7 watts. .12 amps.

Order No.	List Price
<b>7-3905</b> Sold 2 Per Card, Box of 5 Cards Only	<b>\$3.99</b> FO-9720000

SIZE 57

- 14 volts. 3.4 watts. .24 amps.

Order No.	List Price
<b>7-3910</b> Sold 2 Per Card, Box of 5 Cards Only	<b>\$3.99</b> FO-9720000

SIZE 1816

- 13 volts. 4 watts. .33 amps.

Order No.	List Price
<b>219724</b> Sold Each, Standard Pack 10	<b>\$1.49</b> FO-4010000

SIZE 1850

- 5 volts. .5 watts. .09 amps.

Order No.	List Price
<b>219765</b> Sold Each, Standard Pack 10	<b>\$1.99</b> B0-9710000

LIMITED QUANTITIES

SIZE 1895

- 14 volts. 3.8 watts. .27 amps.

Order No.	List Price
<b>7-4000</b> Sold 2 Per Card, Box of 5 Cards Only	<b>\$5.69</b> FO-8930000

Miniature Base Phenolic Lampholder with Leads



- 125 volt, 75 watt.

Order No.	Mfg. No. / Description	List Price
<b>662571</b>	(3711DM)	<b>\$3.99</b> B0-9530000

SPECIAL HANDLING MAY APPLY



## Bulbs for Aqua Signal Lights

- For Aqua Signal Series 70 Lights.
- Double contact bayonet base.
- 120 volt, 60 watt.

Order No. Mfg. No. / Description  
**207515** (10123/90172-)

List Price  
**\$44.49** 60-1892000



- For Aqua Signal Series 55 Lights.
- Double contact bayonet base offset pins.
- 120 volt, 35 watt.

Order No. Mfg. No. / Description  
**207464** (10052/90286-)

List Price  
**\$33.29** 60-0322000



## Double Contact Bayonet Base Bulbs



## SIZE 68

- 13.5 volts. 8 watts. .59 amps.

Order No. List Price  
**7-3920** Sold 2 Per Card, Box of 5 Cards Only **\$5.09** F0-6530000

## SIZE 90

- 13 volts. 7.5 watts. .58 amps.

Order No. List Price  
**7-3936** Sold 2 Per Card, Box of 5 Cards Only **\$5.49** F0-4830000  
**219469** Sold Each, Standard Pack 10 **\$1.89** F0-2310000

## SIZE 90C

- 130 volts. 15 watts.

Order No. List Price  
**219800** Sold Each, Standard Pack 10 **\$1.79** H0-7010000

## SIZE 94

- 12.8 volts. 13.3 watts. 1.04 amps.

Order No. List Price  
**7-3946** Sold 2 Per Card, Box of 5 Cards Only **\$6.59** F0-1640000

## SIZE 1004

- 12.8 volts. 12 watts. .94 amps.

Order No. List Price  
**7-3966** Sold 2 Per Card, Box of 5 Cards Only **\$5.49** F0-4830000  
**219534** Sold Each, Standard Pack 10 **\$2.39** F0-7610000

## SIZE 1034

- 12.8 volts. 23 watts. 1.8 amps.

Order No. List Price  
**7-3970** Sold 2 Per Card, Box of 5 Cards Only **\$5.49** F0-4830000

## SIZE 1142

- 12.8 volts. 18.4 watts. 1.44 amps.

Order No. List Price  
**7-3980** Sold 2 Per Card, Box of 5 Cards Only **\$5.49** F0-4830000

## SIZE 1157

- 12.8 volts. 14 watts. .71 amps.

Order No. List Price  
**7-3991** Sold 2 Per Card, Box of 5 Cards Only **\$4.59** F0-1230000  
**219596** Sold Each, Standard Pack 10 **\$1.69** F0-8110000

## Single Contact Bayonet Base Bulbs



7-3940



7-3986



7-3915

## SIZE 67

- 13.5 volts. 8 watts. .59 amps.

Order No. List Price  
**7-3915** Sold 2 Per Card, Box of 5 Cards Only **\$5.09** F0-6530000

## SIZE 93

- 12.8 volts. 1.04 watts. 13.312 amps.

Order No. List Price  
**7-3940** Sold 2 Per Card, Box of 5 Cards Only **\$5.09** F0-6530000

## SIZE 1141

- 12.8 volts. 18.4 watts. 1.44 amps.

Order No. List Price  
**7-3975** Sold 2 Per Card, Box of 5 Cards Only **\$5.49** F0-4830000

## SIZE 1156

- 12.8 volts. 26.88 watts. 2.1 amps.

Order No. List Price  
**7-3986** Sold 2 Per Card, Box of 5 Cards Only **\$4.59** F0-1230000

## Marpac L.E.D. Replacement Bulbs



7-51582



7-51580



7-51283



1-51588

- Popular light bulb replacements in LED.

Order No.	Description	List Price	
<b>7-51283</b>	1004 LED Bulb	<b>\$14.09</b>	F0-6890000
<b>7-51580</b>	906 LED Bulb	<b>\$3.79</b>	G0-4520000
<b>7-51582</b>	194 LED Bulb	<b>\$3.99</b>	F0-9720000
<b>1-51588</b>	1157 LED Bulb	<b>\$10.59</b>	H0-5360000

## Marpac L.E.D. Replacement Bulbs - 360°



- Double contact.
- Long Life LED replaces the most popular sternlight bulbs on the market.
- Direct replacement for #90 incandescent bulb.
- Low power consumption, yet ultra bright.
- 12 volt.
- Sold each.

Order No.	Description	List Price	
<b>7-7200</b>	L.E.D. Replacement Bulb - 360°	<b>\$5.69</b>	G0-1830000

Electronics

Trolling Motors

Instruments

Electrical

Lighting

Anchor &amp; Dock

Safety

Steering, Controls

Pumps

Fuel System

Seating &amp; Pedestals

Trailering

Tops &amp; Covers

Perform.

Propellers

Engine &amp; Care

Cleaning &amp; Care

Paint &amp; Paint Acc.

Fun &amp; Flotation

Topside Acc.

Cockpit &amp; Deck

Hardware, Fasteners

Camouflage

Misc.

Comm.



**Perko Fig. 374 Double Contact Bayonet Bulbs**



- Clear Type T-8. C-8.
- Filament, length 1-3/8".
- 30 watt.
- Standard pack 50.

Order No.	Mfg. No. / Description	List Price	
<b>528387</b>	(0374 001 CLR) 12 volt	<b>\$71.69</b>	F0-8105000
<b>528399</b>	(0374 002 CLR) 24 volt	<b>\$71.69</b>	F0-8105000
<b>528402</b>	(0374 003 CLR) 32 volt	<b>\$71.69</b>	F0-8105000
<b>528414</b>	(0374 004 CLR) 120 volt	<b>\$79.89</b>	F0-2955000

**Perko Double Contact Bayonet Base Bulb**



- Red bulb.
- 12 volt, 18 watt, 1.53 amp.
- Standard pack 2.

**LIMITED QUANTITIES**

Order No.	Mfg. No. / Description	List Price	
<b>544469</b>	(0337 R12 DP)	<b>\$41.69</b>	G0-3972000

**Marpac Wedge Base Bulbs**



- Sold 2 per card, Box of 5 cards only.

Order No.	Description	List Price	
<b>7-3925</b>	(70) 14 volt 2.1 watt .15 amp	<b>\$5.79</b>	F0-5040000
<b>7-3951</b>	(194) 14 volt 3.8 watt .27 amp	<b>\$3.19</b>	F0-3220000

**Wedge Base Bulbs**



- Sold each. Standard pack 10.

Order No.	Mfg. No. / Description	List Price	
<b>219476</b>	(182085) 161 14 volt 2.66 watt .19 amp	<b>\$1.39</b>	F0-7900000
<b>219483</b>	(181135) 194 14 volt 3.8 watt .27 amp	<b>\$1.49</b>	F0-4010000

**Marpac Festoon Bulbs**



**Perko Fig. 342 Medium Prefocus Bulbs - Clear**



- 120 volt bulbs for 1150 Series and other navigation lights.
- Standard pack 25.

Order No.	Mfg. No. / Description	List Price	
<b>528274</b>	(0342 003 CLR) 40 watt	<b>\$51.99</b>	D0-9514000
<b>528286</b>	(0342 004 CLR) 60 watt	<b>\$51.99</b>	D0-9514000
<b>528298</b>	(0342 RS4 CLR) 60 watt, For Rough Service	<b>\$76.69</b>	D0-5316000

**Perko Fig. 375 Double Contact Bayonet Indexing Base Bulbs**



Order No.	Mfg. No. / Description	List Price	
<b>528503</b>	(0375 12V 10W) 12 volt 10 watt .83 amp	<b>\$50.49</b>	F0-4353000
<b>528515</b>	(0375 12V 25W) 12 volt 25 watt 2.08 amp	<b>\$55.49</b>	F0-4883000
<b>528527</b>	(0375 24V 25W) 24 volt 25 watt 1.04 amp	<b>\$54.59</b>	F0-1283000
<b>528539</b>	(0375 32V 25W) 32 volt 25 watt .78 amp	<b>\$68.59</b>	F0-1084000

**Perko Utility Spare Bulb**



- Spare Part for PERKO Figure No. 1211, 1212, 1421, 1421, 1422 (Removable Bi-Color Pole Light with Utility Light).

Order No.	Mfg. No. / Description	List Price	
<b>5315138</b>	(0064 000 CLR)	<b>\$8.39</b>	F0-7850000

**Perko Fig. 338 Wedge Base Bulbs**



- 12 volt.
- Price 2 bulbs per card. Standard pack 5.

Order No.	Mfg. No. / Description	List Price	
<b>537471</b>	(0338 DP1 CLR) 5 watt .35 amp	<b>\$10.69</b>	F0-8470000
<b>537475</b>	(0338 DP2 CLR) 9 watt .69 amp	<b>\$11.19</b>	F0-3870000

- Sold 2 per card, Box of 5 cards only.

Order No.	Description	List Price	
<b>7-3955</b>	12.8 volt 12 watt .97 amp	<b>\$6.99</b>	F0-9840000
<b>7-3960</b>	13.5 volt 10 watt .75 amp	<b>\$6.99</b>	F0-9840000

- Electronics
- Trolling Motors
- Instruments
- Electrical
- Lighting
- Anchor & Dock
- Safety
- Steering, Controls
- Pumps
- Fuel System
- Seating & Pedestals
- Trailering
- Tops & Covers
- Perform.
- Propellers
- Engine & Care
- Cleaning & Care
- Paint & Paint Acc.
- Fun & Flotation
- Topside Acc.
- Cockpit & Deck
- Hardware, Fasteners
- Camouflage
- Misc.
- Comm.

**Marpac L.E.D. Festoon Bulb**



- 3 sided - 9 cool white LED's.
- Length 1-1/8", diameter 3/8".
- Low amp draw: 30mA. 25 lumens.
- Replaces Perko 0071 Bulbs.

Order No.	Description	List Price	
<b>7-38877</b>	LED Festoon Bulb	<b>\$6.89</b>	F0-2840000

**Marpac Festoon Bulbs**



- Sold 2 per card, Box of 5 cards only.

Order No.	Description	List Price	
<b>7-4010</b>	12 volt 15 watt .97 amp	<b>\$5.99</b>	F0-9140000
<b>7-4020</b>	12 volt 23 watt .80 amp	<b>\$5.89</b>	F0-2140000

**Sealed Beam - Type: PAR-56**

- Type: PAR-56.
- Spot.
- Diameter 7".
- 12 volt, 100 watt.
- Sold each.



Order No.	Mfg. No. / Description	List Price	
<b>220462</b>	(0433 003 12V)	<b>\$108.59</b>	F0-1067000

**Halogen Quartz Lamps - Double Ended**



- Length 4.68".
- 130 volt, 500 watt.

Order No.	Mfg. No.	List Price	
<b>219813</b>	(0715Y)	<b>\$5.99</b>	B0-9350000

**LIMITED QUANTITIES**

**Fluorescent Bulbs**



Order No.	Mfg. No. / Description	List Price	
<b>378490</b>	(0301U) 12 volt 8 watt Length 1'	<b>\$9.99</b>	B0-9980000
<b>569106</b>	(04499C) 17 watt Length 2'	<b>\$5.19</b>	H0-1130000
<b>569117</b>	(00669B) 20 watt Length 2'	<b>\$4.49</b>	H0-9620000
<b>569107</b>	(S8420) 32 watt Length 4'	<b>\$6.19</b>	H0-1730000

**Perko Festoon Bulbs - Double Ended**



Bulb Diameter: 9/16"



Bulb Diameter: 3/8"

- Sold 2 bulbs per card. Standard pack 5.

**BULB DIAMETER: 3/8"**

Order No.	Mfg. No. / Description	List Price	
<b>541664</b>	(0071 DP8 CLR) 12 volt, 8 watt 1-1/8" L	<b>\$19.89</b>	F0-2931000
<b>541530</b>	(0069 DPO CLR) 12 volt, 10 watt 1-5/8" L	<b>\$18.79</b>	F0-5131000
<b>541626</b>	(0070 DPO CLR) 12 volt, 10 watt 1-11/16" L	<b>\$15.09</b>	F0-6501000
<b>541739</b>	(0071 DPO CLR) 12 volt, 10 watt 1-1/8" L	<b>\$14.89</b>	F0-2401000
<b>541740</b>	(0072 DP1 CLR) 24 volt, 10 watt 1-1/8" L	<b>\$22.19</b>	F0-3551000
<b>541640</b>	(0070 DP2 CLR) 32 volt, 12 watt 1-5/8" L	<b>\$17.19</b>	F0-3021000

**BULB DIAMETER: 9/16"**

Order No.	Mfg. No. / Description	List Price	
<b>541638</b>	(0070DP1CLR) 12 volt, 15 watt 1-11/16" L	<b>\$15.99</b>	F0-9111000
<b>541501</b>	(0067 DP2 CLR) 24 volt, 18 watt 1-11/16" L	<b>\$19.49</b>	F0-4631000

**Sealed Beam - Type: PAR-36.**

- Type: PAR-36.
- Diameter 4-1/4".
- 4.7 volt, 2 watt, .5 amp.
- Sold each.

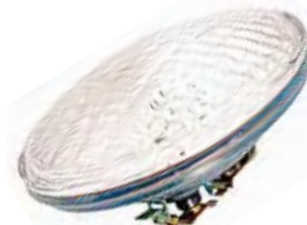

Order No.	Mfg. No. / Description	List Price	
<b>220486</b>	(1424Z)	<b>\$27.99</b>	B0-9152000

**Marpac Marine Light Bulb Display**



- All bulbs packed 2 per display package.
- This display includes 5 bags of the following:
  - 7-3905 (53) Mini Bayonet Base
  - 7-3910 (57) Mini Bayonet Base
  - 7-3915 (67) Single Contact Bayonet Base
  - 7-3920 (68) Double Contact Bayonet Base
  - 7-3925 (70) Wedge Base
  - (71) Single Contact Bayonet Base
  - 7-3936 (90) Double Contact Bayonet Base
  - 7-3940 (93) Single Contact Bayonet Base
  - 7-3946 (94) Double Contact Bayonet Base
  - 7-3950 (194) Wedge Base
  - 7-3955 (211) Festoon
  - 7-3960 (212) Festoon
  - 7-3966 (1004) Double Contact Bayonet Base
  - 7-3970 (1034) Double Contact Bayonet Base
  - 7-3975 (1141) Single Contact Bayonet Base
  - 7-3986 (1156) Single Contact Bayonet Base
  - 7-3991 (1157) Double Contact Bayonet Base
  - 7-4000 (1895) Mini Bayonet Base
  - 7-4020 (71 DP CLR) Festoon



Order No.	Description	List Price	
<b>7-3006</b>	Marine Light Bulb Display	<b>\$609.89</b>	F0-2962400



**SPECIAL HANDLING MAY APPLY**



- Electronics
- Trolling Motors
- Instruments
- Electrical
- Lighting
- Anchor & Dock
- Safety
- Steering, Controls
- Pumps
- Fuel System
- Seating & Pedestals
- Trailering
- Tops & Covers
- Perform.
- Propellers
- Engine & Care
- Cleaning & Care
- Paint & Paint Acc.
- Fun & Flotation
- Topside Acc.
- Cockpit & Deck
- Hardware, Fasteners
- Camouflage
- Misc.
- Comm.

**Perko Fig. 303 Dual Medium Prefocus Socket Assembly**



- Phenolic. 250 volts, 1,000 watts.
- Prewired with two medium prefocus sockets.
- For use in 1164 Series double lens lights.
- Overall height 3-7/8", overall width 3-7/8".

Order No.	Mfg. No. / Description	List Price	
<b>529428</b>	(0303)	<b>\$186.59</b>	A0-9568100
<b>529430</b>	(0303 A00) Male Plug Only	<b>\$14.39</b>	A0-9341000
<b>529442</b>	(0303 B00) Female Socket Only	<b>\$11.59</b>	A0-9511000

**Perko Fig. 347 Medium Prefocus Socket**



- Phenolic. 250 volts, 1,000 watts.
- Includes: Metal mounting cap tapped for 3/8" IPS.
- Overall height 1-7/8", overall diameter 1-1/2".

Order No.	Mfg. No. / Description	List Price	
<b>529404</b>	(0347 A00)	<b>\$67.69</b>	A0-9676000

**Perko Fig. 276 Double Contact Bayonet Socket**



- Replacement socket for Perko Figs. 02 and 06 White All-Round Lights - under 20 meters in length.
- Brass with 6" wire leads.
- Tapped for 1/8" pipe.
- Overall length 2".

Order No.	Mfg. No. / Description	List Price	
<b>529644</b>	(0276 002)	<b>\$20.49</b>	F0-4341000

**Perko Fig. 24 Double Contact Bayonet Socket**



- Black polymer body.
- OD 3/4". Pigtail length 10".

Order No.	Mfg. No. / Description	List Price	
<b>535976</b>	(0024 DP1)	<b>\$9.79</b>	F0-5860000

**Searchlight Projection Bulbs**



(2) Medium Prefocus  
219825



(3) Mogul Screw  
219976

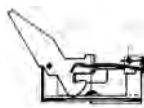

(4) 2-Pin Prefocus  
220020

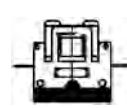

(6) 2-Pin Prefocus  
220070

DMI #	MFG. Bulb Code	Voltage	Wattage	Socket Type	List Price	
<b>219825</b>	BTM	120	500	Medium Prefocus Base (2)	<b>\$52.69</b>	H0-1613000
<b>219837</b>	BTP	120	750	Medium Prefocus Base (2)	<b>\$46.29</b>	H0-7772000
<b>219849</b>	BTR	120	1,000	Medium Prefocus Base (2)	<b>\$46.29</b>	H0-7772000
<b>219851</b>	BVA	120	900	2-Pin Prefocus Base (6)	<b>\$79.97</b>	H0-8974000
<b>219976</b>	DPT	120	1,000	Mogul Screw Base (3)	<b>\$88.59</b>	H0-5135000
<b>220020</b>	DYS	120	600	2-Pin Prefocus Base (4/6)	<b>\$36.79</b>	H0-7022000
<b>220070</b>	FDT	12	100	2-Pin Prefocus Base (4/6)	<b>\$31.69</b>	H0-1091000

- Electronics
- Trolling Motors
- Instruments
- Electrical
- Lighting
- Anchor & Dock
- Safety
- Steering, Controls
- Pumps
- Fuel System
- Seating & Pedestals
- Trailering
- Tops & Covers
- Perform.
- Propellers
- Engine & Care
- Cleaning & Care
- Paint & Paint Acc.
- Fun & Flotation
- Topside Acc.
- Cockpit & Deck
- Hardware, Fasteners
- Camouflage
- Misc.
- Comm.