

Catálogo de accesorios Náuticos



2025

El Navegante

www.repuestoselnavegante.com



1,000 lbs. Swing-Up Trailer Jack



- Fits 3" x 5" trailer tongues.
- Provides up to 21" of lift.
- Locking pin for added strength and support.
- Non-slip handle for a more comfortable and secure grip.
- Mounting hardware included.



Order No. Description List Price
7-1585 Swing-Up Trailer Jack **\$37.09** F0-6952000

1,000 lbs. Swivel Trailer Jack



- 10" total travel.
- 25" maximum tongue height.
- Side wind handle with extra heavy screw drive and ergonomic handle grip.
- Heavy duty polypropylene 8" diameter slotted wheel.
- Zinc plated Tuffplate finish.



Order No. Mfg. No. / Description List Price
685570 (22359) **\$138.49** F0-4969000

1,000 lbs. Swivel Trailer Jack



- 10" total travel.
- 25" maximum tongue height.
- Side wind handle with extra heavy screw drive and ergonomic handle grip.
- Heavy duty polypropylene 6" diameter wheel.
- Zinc plated Tuffplate finish.



Order No. Mfg. No. / Description List Price
388238 (22457) **\$135.99** F0-9159000

1,200 lbs. Swivel Trailer Jack



- 10" total travel.
- 25" maximum tongue height.
- Side wind handle with extra heavy screw drive and ergonomic handle grip.
- Heavy duty polypropylene 6" diameter wheel.
- Zinc plated Tuffplate finish.



Order No. Mfg. No. / Description List Price
388226 (22300) **\$117.99** F0-9528000

NEW PRODUCT

1,500 lbs. Swing-Up Trailer Jack



- Corrosion resistant.
- Heavy duty 1/2" spring pull pin.
- Extends from 14-1/2" to 26-1/2".
- Travel distance: 12".
- Fits 2" x 2" to 3" x 5" trailer tongues.
- Wheel size: 8" diameter x 2" wide.
- Grease port for easy lubrication.
- Mounting hardware included.



Order No. Description List Price
7-1598 Swing-Up Trailer Jack **\$81.79** G0-0845000

1,500 lbs. Swivel Trailer Jack



- 10" total travel.
- 24-3/4" maximum tongue height.
- Side wind handle with extra heavy screw drive and ergonomic handle grip.
- Heavy duty polypropylene 8" diameter slotted wheel.
- Zinc plated Tuffplate finish.



Order No. Mfg. No. / Description List Price
685580 (22800) **\$162.19** F0-3531100

1,500 lbs. Swivel Trailer Jack



- 10" total travel.
- 24-3/4" maximum tongue height.
- Side wind handle with extra heavy screw drive and ergonomic handle grip.
- Heavy duty polypropylene 8" diameter slotted wheel.
- Zinc plated Tuffplate finish.
- Independent wheel (wheel bracket rotates independent from inner post).



Order No. Mfg. No. / Description List Price
388276 (22802) **\$183.99** F0-9782100

NEW PRODUCT

1,500 lbs. Swivel Trailer Jack



- 12" total travel.
- 28-1/2" maximum tongue height.
- Side wind handle with extra heavy screw drive and ergonomic handle grip.
- Heavy duty polypropylene 8" diameter (3" wide) slotted wheel.
- Powder coated matte black finish over zinc plating.
- Dual grease fittings.
- Vinyl sleeve on 1/2" swivel pin.



Order No. Mfg. No. / Description List Price
388202 (22335) **\$289.99** F0-9920200

NEW PRODUCT

1,500 lbs. Deluxe Trailer Jack



- 1,500 lbs. load capacity.
- 10" travel distance.
- Designed to fit tongues up to 3" x 5".
- Zinc-plated undercoat with a tough black textured overcoat.
- A durable crank handle and a heavy duty 6" wheel make managing your trailer load easy and comfortable.



Order No. Mfg. No. / Description List Price
840500 (054650-10) **\$128.95** Z0-6209000

1,500 lbs. Deluxe Plus Trailer Jack



- 1,500 lbs. load capacity.
- 12" travel distance.
- Designed to fit tongues up to 3" x 5".
- Zinc-plated undercoat with a tough black textured overcoat.
- 8" heavy duty wheel, and a wheel caster that swivels independently from the inner post.
- Includes two grease ports.
- Extended sleeved pull pin.
- Comfort grip handle.



Order No. Mfg. No. / Description List Price
840513 (054655-10) **\$178.55** Z0-9942100

2,000 lbs. Swing-Up Trailer Jack
WIDE WHEEL



- Wheel size: 8" diameter x 4" wide.
- Corrosion resistant.
- Heavy duty dual pin.
- Extends from 11" to 25".
- Travel distance: 14".
- Fits trailer tongues from 2" x 2" to 3" x 5".
- Grease port for easy lubrication.
- Mounting hardware included.



Order No. Description List Price
7-1599 Swing-Up Trailer Jack **\$115.59** G0-5477000

1,500 lbs. Swivel Trailer Jack
DUAL WHEEL



- 12" total travel.
- 28" maximum tongue height.
- Side wind handle with extra heavy screw drive and ergonomic handle grip.
- Heavy duty polypropylene dual 6" diameter wheels.
- Zinc plated Tuffplate finish.



Order No. Mfg. No. / Description List Price
685585 (22580) **\$176.89** F0-2832100

- Electronics
- Trolling Motors
- Instruments
- Electrical
- Lighting
- Anchor & Dock
- Safety
- Steering, Controls
- Pumps
- Fuel System
- Seating & Pedestals
- Trailer**
- Tops & Covers
- Perform.
- Propellers
- Engine & Care
- Cleaning & Care
- Paint & Paint Acc.
- Fun & Flotation
- Topside Acc.
- Cockpit & Deck
- Hardware, Fasteners
- Camouflage
- Misc.
- Comm.

300 lbs. PWC Swing-Up Trailer Stand



- Ideal for any small utility trailer.
- "Swing-Away" design mounts under, not beside, trailer tongue.
- Solid wheel locks in down position and pivots out of the way for trailering.
- Tongue size: 3" x 3".
- Perfect for: PWC, snowmobile and motorcycle trailers.
- Clearance: 15".

Order No.	Description	List Price	
7-1613	PWC Trailer Jack Stand	\$16.99	GO-8311000

2,500 lbs. Drop-Leg Trailer Jack



- Fits 3" x 5" trailer tongues.
- Provides up to 31" of lift.
- Zinc plated for corrosion resistance.
- Easy adjustments with quick release thumb pin.
- Continued smooth operation when lubricated using convenient grease fitting.
- 6 hole design reduces crank time and effort.
- Mounting hardware included.

Order No.	Description	List Price	
7-1588	Drop-Leg Trailer Jack	\$101.69	GO-3186000

2,500 lbs. Square Tube Trailer Jack



- 15" total travel.
- 38-1/2" maximum tongue height.
- Side wind handle with extra heavy screw drive and ergonomic handle grip.
- Lengthen and shorten quickly by pulling lynch pin.
- Zinc plated finish.

Order No.	Mfg. No. / Description	List Price	
685590	(22320)	\$155.59	FO-1980100

2,000 lbs. A-Frame Jack



- 13" of vertical travel.
- Retracted length of 8-1/2", extended length of 21-1/2".
- Corrosion resistant black powder coated finish.
- Strong 2" diameter tube.
- Either weld-on or bolt-on (bolts not included).
- Slotted universal fit mounting bracket.
- **Note: Ground support must be purchased separately.**

Order No.	Description	List Price	
7-1615	A-Frame Jack Only	\$46.59	GO-2213000
7-1616	Foot Plate	\$10.99	GO-6370000
7-1618	Jack Castor - Swivel	\$21.49	GO-0441000

Replacement Trailer Jack Wheels



Order No.	Description	List Price	
7-1620	2" Wide x 6" Diameter	\$11.19	GO-0570000
7-1621	2" Wide x 8" Diameter	\$25.49	GO-8071000

Trailer Wheel Stop



- Lower your jack wheel into the wheel stop to prevent the tongue from moving.
- Always block your tires.

Order No.	Description	List Price	
7-59202	Wheel Stop	\$6.39	GO-8240000

**600 lbs. Trailer Winch with 12' Strap
SINGLE SPEED**



- Corrosion resistant zinc coating.
- Two-way ratchet with neutral.
- Gear ratio: 3:1.
- Includes 12' winch strap with hook.
- Ergonomic handle.

Order No.	Description	List Price	
7-1597	Trailer Winch	\$44.19	GO-1692000

**600 lbs. Trailer Winch
SINGLE SPEED**



- 7" handle with ergonomic handle grip.
- Freewheel operation for easy line removal.
- Zinc plated Tuffplate finish.

Order No.	Mfg. No. / Description	List Price	
685600	(14125)	\$47.29	FO-0133000

**1,000 lbs. Trailer Winch with 12' Strap
SINGLE SPEED**



- Corrosion resistant zinc coating.
- Two-way ratchet with neutral.
- Gear ratio: 4:1.
- Includes 12' winch strap with hook.
- Ergonomic handle.

Order No.	Description	List Price	
7-1589	Trailer Winch	\$54.39	GO-4463000

**1,100 lbs. Trailer Winch
SINGLE SPEED**



- 7" handle with ergonomic handle grip.
- Freewheel operation for easy line removal.
- Zinc plated Tuffplate finish.

Order No.	Mfg. No. / Description	List Price	
685605	(15103)	\$61.19	FO-3824000

**1,400 lbs. Trailer Winch with 12' Strap
SINGLE SPEED**



- Corrosion resistant zinc coating.
- Two-way ratchet with neutral.
- Gear ratio: 4:1.
- Includes 12' winch strap with hook.
- Ergonomic handle.

Order No.	Description	List Price	
7-1591	Trailer Winch	\$56.89	GO-2183000

**1,400 lbs. Trailer Winch
SINGLE SPEED**



- 7" handle with ergonomic handle grip.
- Freewheel operation for easy line removal.
- Zinc plated Tuffplate finish.

Order No.	Mfg. No. / Description	List Price	
388024	(15303) No Strap	\$89.99	FO-9926000
685616	(15305) 20' Strap	\$109.79	FO-5867000

NEW MODEL

- Electronics
- Trolling Motors
- Instruments
- Electrical
- Lighting
- Anchor & Dock
- Safety
- Steering, Controls
- Pumps
- Fuel System
- Seating & Pedestals
- Trailer**
- Tops & Covers
- Perform.
- Propellers
- Engine & Care
- Cleaning & Care
- Paint & Paint Acc.
- Fun & Flotation
- Topside Acc.
- Cockpit & Deck
- Hardware, Fasteners
- Camouflage
- Misc.
- Comm.

**1,500 lbs. Trailer Winch with 20' Strap
SINGLE SPEED**



- 9-1/2" handle with ergonomic handle grip.
- Freewheel operation for easy line removal.
- Powder coated matte black finish on base, zinc plated Tuffplate finish.
- Reversible ratch allows cranking of cable or strap onto winch drum in either direction.

NEW PRODUCT

Order No. **387907** Mfg. No. / Description (17027) List Price **\$171.99** F0-9302100

**1,600 lbs. Trailer Winch
SINGLE SPEED**



- 9-1/2" offset handle with ergonomic handle grip.
- Freewheel operation for easy line removal.
- Zinc plated Tuffplate finish.
- Reversible ratch allows cranking of cable or strap onto winch drum in either direction.

NEW PRODUCT

Order No. **388036** Mfg. No. / Description (14527) List Price **\$103.99** F0-9727000

**1,800 lbs. Trailer Winch with 15' Strap
SINGLE SPEED**



- Corrosion resistant zinc coating.
- Two-way ratchet with neutral.
- Gear ratio: 5:1.
- Includes 15' winch strap with hook.
- Ergonomic handle.

Order No. **7-1592** Description Trailer Winch List Price **\$73.19** G0-4094000

**1,800 lbs. Trailer Winch
SINGLE SPEED**



- 9-1/2" offset handle with ergonomic handle grip.
- Freewheel operation for easy line removal.
- Zinc plated Tuffplate finish.
- Reversible ratch allows cranking of cable or strap onto winch drum in either direction.

Order No. **685623** Mfg. No. / Description (14627) List Price **\$118.09** F0-6628000

**1,900 lbs. Trailer Winch with 20' Strap
SINGLE SPEED**



- 9-1/2" offset handle with ergonomic handle grip.
- Freewheel operation for easy line removal.
- Powder coated matte black finish on base, zinc plated Tuffplate finish.
- Reversible ratch allows cranking of cable or strap onto winch drum in either direction.

NEW PRODUCT

Order No. **387919** Mfg. No. / Description (17048) List Price **\$223.99** F0-9765100

**2,000 lbs. Trailer Winch with 20' Strap
DUAL GEAR**



- Corrosion resistant zinc coating.
- Two-way ratchet with neutral.
- Gear ratio: 4:1.
- Dual drive gears for uniform torque with better stability and more power.
- Ergonomic handle.
- Includes: 20' winch strap with hook.

Order No. **7-1594** Description Trailer Winch List Price **\$73.29** G0-0194000

**2,500 lbs. Trailer Winch with 20' Strap & Brake
TWO SPEED**



- Corrosion resistant zinc coating.
- Two-way ratchet with neutral.
- Two speeds with 5:1 and 12:1 gear ratios.
- Hand brake included for safety.
- Ergonomic handle.
- Includes: 2-1/2" x 20' winch strap with hook.

Order No. **7-1596** Description Trailer Winch List Price **\$133.29** G0-0398000

**2,500 lbs. Trailer Winch
TWO SPEED**



- 9-1/2" quick-attach handle with ergonomic handle grip.
- Freewheel operation for easy line removal.
- Zinc plated Tuffplate finish.
- Reversible ratch allows cranking of cable or strap onto winch drum in either direction.

NEW PRODUCT

Order No. **388062** Mfg. No. / Description (14825) List Price **\$223.99** F0-9765100

**2,500 lbs. Trailer Winch with 25' Strap
TWO SPEED**



- 9-1/2" quick-attach handle with ergonomic handle grip.
- Freewheel operation for easy line removal.
- Zinc plated Tuffplate finish.
- Reversible ratch allows cranking of cable or strap onto winch drum in either direction.

Order No. **1601863** Mfg. No. / Description (14846) List Price **\$219.99** G0-9374100

**3,200 lbs. Trailer Winch
TWO SPEED**



- 9-1/2" quick-attach handle with ergonomic handle grip.
- Freewheel operation for easy line removal.
- Zinc plated Tuffplate finish.
- Reversible ratch allows cranking of cable or strap onto winch drum in either direction.

NEW PRODUCT

Order No. **388074** Mfg. No. / Description (15440) List Price **\$281.99** F0-9379100

**1,500 lbs. Trailer Winch with Brake
SINGLE SPEED**



- 9-3/8" handle with ergonomic handle grip.
- Built in fully automatic friction brake holds load exactly in position when raising and lowering.
- Zinc plated Tuffplate finish.

NEW PRODUCT

Order No. **388101** Mfg. No. / Description (14964) List Price **\$221.99** F0-9355100

**2,500 lbs. Trailer Winch with Brake
SINGLE SPEED**



- 9-3/8" handle with ergonomic handle grip.
- Built in fully automatic friction brake holds load exactly in position when raising and lowering.
- Zinc plated Tuffplate finish.

NEW PRODUCT

Order No. **388113** Mfg. No. / Description (15721) List Price **\$291.99** F0-9340200

- Electronics
- Trolling Motors
- Instruments
- Electrical
- Lighting
- Anchor & Dock
- Safety
- Steering, Controls
- Pumps
- Fuel System
- Seating & Pedestals
- Trailer**
- Tops & Covers
- Perform.
- Propellers
- Engine & Care
- Cleaning & Care
- Paint & Paint Acc.
- Fun & Flotation
- Topside Acc.
- Cockpit & Deck
- Hardware, Fasteners
- Camouflage
- Misc.
- Comm.

- Electronics
- Trolling Motors
- Instruments
- Electrical
- Lighting
- Anchor & Dock
- Safety
- Steering, Controls
- Pumps
- Fuel System
- Seating & Pedestals
- Trailer**
- Tops & Covers
- Perform.
- Propellers
- Engine & Care
- Cleaning & Care
- Paint & Paint Acc.
- Fun & Flotation
- Topside Acc.
- Cockpit & Deck
- Hardware, Fasteners
- Camouflage
- Misc.
- Comm.

**3,500 lbs. Trailer Winch with Brake
TWO SPEED**



- 9-1/2" quick-attach handle with ergonomic handle grip.
- Hand brake for manually-controlled load release.
- Zinc plated Tuffplate finish.

NEW PRODUCT

Order No. Mfg. No. / Description List Price
388149 (14881) **\$483.99** FO-9783300

**900 lbs. Trailer Winch
PWC**



- 4.1 to 1 gear ratio.
- Ergonomic handle.
- It has up to 900 lb. capacity with solid gear construction, zinc plated.
- 2" x 12' strap with bow loop and hook.
- Two way ratchet with free spool.

Order No. Description List Price
7-1602 Trailer Winch **\$33.39** GO-7322000

Comfort Grip Winch Handle



- Zinc plating offers maximum corrosion resistance.
- Ergonomic comfort grip included.
- Universal design fits most winches.

Order No. Description List Price
7-1600 Winch Handle **\$21.29** GO-6241000

SKYWinch



- SKYWinch is the opposite of traditional winches and eliminates the hassles and dangers of trailering.
- Simply leave a bow-line attached to your boat and walk it to your trailer without wading in. Then just place rope into SKYWinch, pull tight, and start cranking.
- The Patented wheel grips the rope and easily pulls most lighter-weight boats under 18'.
- The crank arm will not spin backwards until released with trigger for control led payout.
- Accepts ropes to 1/2" diameter and fits most standard trailers with included mounting bracket & hardware.
- For best results, use with 1/2" solid-braid rope with break strength rating that exceeds boat weight.

LIMITED QUANTITIES

Order No. Mfg. No. / Description List Price
1980050 (SKYWINCH) **\$84.69** G1-5055000

Model 912 Trailer Winch



POWERWINCH

- UV resistant ABS plastic housing.
- Zinc plated frame.
- Power-in/Freewheel-out.
- Manual hand crank included.
- Level wind system - prevents cable snarls.
- For boats 23' to 30' in length.
- Maximum boat weight: 11,500 lbs.
- Line speed: 8 fpm.
- Includes: 40' x 7/32" aircraft quality cable with pulley block.
- Dimensions: 10" x 10" x 8".
- Circuit breaker: 60 amp.

Order No. Mfg. No. / Description List Price
2887912 (P77912) **\$780.09** E0-7058500

Model RC30 Trailer Winch



POWERWINCH

- UV resistant ABS plastic housing.
- Zinc plated frame.
- Power-in/Freewheel-out.
- Manual hand crank included.
- Level wind system - prevents cable snarls.
- Built-in light.
- Remote control.
- For boats 23' to 30' in length.
- Maximum boat weight: 11,500 lbs.
- Line speed: 8 fpm.
- Includes: 40' x 7/32" aircraft quality cable with pulley block.
- Dimensions: 9-1/2" x 11-1/2" x 9".

Order No. Mfg. No. / Description List Price
2885950 (P5950) **\$800.09** E0-7000600

4,500 lbs. Winch Strap with Loop End



- High impact polyester webbing.
- 1,500 lbs. working load.
- Forged steel snap hook.
- Fits standard trailer winches.

Order No. Description List Price
7-59816 2" x 15' Strap **\$10.69** HO-1460000

6,000 lbs. Winch Straps with Loop End



- Heavy duty webbing.
- 2,000 lbs. working load.
- Forged steel snap hook.
- Includes hardware for installation.

Order No. Description List Price
7-2110 2" x 20' Strap **\$8.79** GO-9850000
7-2111 2" x 30' Strap **\$10.49** GO-3070000

8,800 lbs. Winch Strap with Loop End



- Heavy duty webbing.
- 2,930 lbs. working load.
- Forged steel snap hook.
- Includes hardware for installation.

Order No. Description List Price
7-2113 2" x 25' Strap **\$12.29** GO-3280000

5,000 lbs. Winch Strap with Tail



- Polyester webbing.
- 1,665 lbs. working load.
- Forged steel safety snap hook.
- Has a sewn tail for drum installation.

Order No. Mfg. No. / Description List Price
2003855 (WS20T) 20' Strap **\$22.09** FO-6451000

5,000 lbs. Winch Strap with Safety Strap



- Polyester webbing.
- 1,665 lbs. working load.
- Forged steel safety snap hook.
- Includes: 30" safety strap snap hook, a bolt & nylon lock nut for drum installation.

Order No. Mfg. No. / Description List Price
2003857 (WS20S) 20' Strap **\$28.39** FO-7891000

10,000 lbs. Heavy Duty Yellow Winch Strap



- A 2" wide yellow heavy duty winch strap constructed with webbing.
- Forged steel safety snap hook.

Order No. Mfg. No. / Description List Price
2003860 (WSY25) 25' Strap **\$37.69** FO-8362000

4,000 lbs. Winch Strap with Loop End



BoatBuckle

- 2" polyester webbing.
- Steel forged snap hook.
- SWL: 1,333 lbs.

Order No.	Mfg. No. / Description	List Price	
2095848	(F05848) 20' Strap	\$19.69	Z0-0000000

4,000 lbs. Winch Strap with Tail End



BoatBuckle

- 2" polyester webbing.
- Steel forged snap hook.
- SWL: 1,333 lbs.

Order No.	Mfg. No. / Description	List Price	
2097674	(F07674) 20' Strap	\$17.99	G1-9611000

5,000 lbs. Winch Strap



TIE DOWN

- 2" wide strap.
- Equipped with a heavy duty forged latch hook.

Order No.	Mfg. No. / Description	List Price	
3560475	(50475) 20' Strap	\$27.59	F0-8362000
3560470	(50470) 25' Strap	\$26.59	F0-8362000

4,500 lbs. Winch Strap with PWC Bow Loop



- High impact polyester webbing.
- 1,500 lbs. working load.
- Forged steel snap hook.
- Includes: PWC 1" x 18" bow loop.

Order No.	Description	List Price	
7-59815	2" x 12' Strap	\$9.59	H0-5750000

Trailer Winch Cables



- Galvanized steel 7 x 19 aircraft cable.
- Each cable is fitted with a heavy duty galvanized latch hook, pull proof loop and a fastener end for replacement use on electric winches.
- Also great for hand crank winches.

Order No.	Description	List Price	
7-1845	3/16" x 25' Cable	\$21.39	G0-3341000
7-1846	7/32" x 25' Cable	\$33.89	F0-2732000

LIMITED QUANTITIES

Z-LAUNCH™ Watercraft Launch Cord



- All stainless hardware.
- Expands to more than 2x the length.
- Unlike rope, will not jerk your watercraft.
- Great for ramps with "no power" laws.
- Length 15'.
- For boats 17' to 22'.

Order No.	Mfg. No. / Description	List Price	
6430020	(ZL-15-DP)	\$62.19	F0-3534000

Snap Hook



- Malleable iron.
- 2,300 lbs. breaking strength.
- Length overall 3-1/2". Eye 2".

Order No.	Description	List Price	
7-0288	Snap Trailer Hook	\$5.49	G0-8630000

L.E.D. Waterproof Trailer Light Kit Under 80" Wide Trailer



- Multi-LED.
- Kit includes: (2) LED stud mount tail lights with red side markers/reflectors, 25' wiring harness, 4' trunk connector, license plate bracket, mounting hardware and complete instructions.

Order No.	Description	List Price	
7-0011	Light Kit	\$69.69	F0-8784000

L.E.D. Waterproof Tail Lights Under 80" Wide Trailer



- Multi-LED.
- Stud mount.
- Right hand has 6 functions and left hand has 7 functions.

Order No.	Description	List Price	
7-59332	Passenger	\$23.09	F0-6161000
7-59334	Driver with Illuminator	\$29.79	F0-5802000

L.E.D. Waterproof Tail Lights Under 80" Wide Trailer



- Single LED.
- Sealed, waterproof design.
- Stud mount.
- Hard wired.
- Driver side includes license illuminator.
- Includes mounting hardware.

Order No.	Mfg. No. / Description	List Price	
522770	(TL008RK) Pair	\$34.29	F0-0042000
522778	(STL008RS) Passenger	\$20.99	F0-9641000
522780	(STL009RS) Driver	\$21.99	F0-9351000

Submersible Trailer Light Kit Under 80" Wide Trailer



- Incandescent.
- Kit includes: (2) stud mount tail lights with red side markers/reflectors, 25' wiring harness, 4' trunk connector, license plate bracket, mounting hardware and complete instructions.

Order No.	Description	List Price	
7-0013	Light Kit	\$28.89	F0-2202000
7-59294	Kit with License Plate	\$16.69	F0-8611000

Submersible Tail Lights Under 80" Wide Trailer



- Incandescent.
- Stud mount.
- Right hand has 6 functions and left hand has 7 functions.

Order No.	Description	List Price	
7-59301	Passenger	\$6.39	F0-7440000
7-59302	Driver with Illuminator	\$6.99	F0-9840000

Electronics
Trolling Motors
Instruments
Electrical
Lighting
Anchor & Dock
Safety
Steering, Controls
Pumps
Fuel System
Seating & Pedestals
Trailer
Tops & Covers
Perform.
Propellers
Engine & Care
Cleaning & Care
Paint & Paint Acc.
Fun & Flotation
Topside Acc.
Cockpit & Deck
Hardware, Fasteners
Camouflage
Misc.
Comm.

Submersible Trailer Light Kit
Under 80" Wide Trailer



- Incandescent.
- Sealed, waterproof design.
- Stud mount.
- Hard wired.
- Driver side includes license illuminator.
- Kit includes: (2) stud mount tail lights with red side markers/reflectors, 20' wiring harness, license plate bracket and mounting hardware.

LIMITED QUANTITIES

Order No.	Mfg. No. / Description	List Price	
522951	(TL-9RK) Light Kit	\$29.89	FO-9550000

Submersible Tail Lights
Under 80" Wide Trailer



- Incandescent.
- Stud mount.
- Hard wired.
- Driver side includes license illuminator.

Order No.	Mfg. No. / Description	List Price	
684666	(ST-6RS) Passenger	\$10.59	HO-5360000
684678	(ST-7RS) Driver	\$10.99	HO-9560000

NON-SUBMERSIBLE			
Order No.	Mfg. No. / Description	List Price	
522931	(ST-8RS) Passenger	\$7.99	FO-9550000
522943	(ST-9RS) Driver	\$8.19	FO-3750000

L.E.D. Waterproof Trailer Light Kit
Over 80" Wide Trailer



- Multi-LED.
- Kit includes: (2) LED stud mount tail lights with red side markers/reflectors, wiring harness, license plate bracket and mounting hardware.

Order No.	Description	List Price	
7-59387	Light Kit	\$72.29	FO-0605000

L.E.D. Waterproof Tail Lights
Over 80" Wide Trailer



- Multi-LED.
- Stud mount.
- Right hand has 7 functions and left hand has 8 functions.

Order No.	Description	List Price	
7-59389	Passenger	\$25.49	FO-4871000
7-59388	Driver with Illuminator	\$30.19	FO-3112000

Tail Lights
Over 80" Wide Trailer



- Incandescent.
- Stud mount.
- Right hand has 7 functions and left hand has 8 functions.

Order No.	Description	List Price	
7-59298	Passenger	\$7.99	FO-9550000
7-59299	Driver with Illuminator	\$8.69	FO-8060000

Submersible Tail Lights
Over 80" Wide Trailer



- Incandescent.
- Stud mount.
- Hard wired.
- Driver side includes license illuminator.

Order No.	Mfg. No. / Description	List Price	
522917	(ST-4RS) Passenger	\$10.49	FO-4370000
522929	(ST-5RS) Driver	\$11.79	FO-5280000

L.E.D. Submersible Low Profile Trailer Light Kit
Over 80" Wide Trailer



- Multi-LED.
- Kit includes: (2) LED low profile universal mount tail lights with red side markers/reflectors, 25' wiring harness, 4" trunk connector, license plate bracket, mounting hardware and complete instructions.
- Dimensions: 8" W x 2-7/8" H.

Order No.	Description	List Price	
7-0012	Light Kit	\$68.09	FO-6674000

L.E.D. Submersible Low Profile Tail Lights
Over 80" Wide Trailer



- Multi-LED.
- Universal mount.
- Right hand has 7 functions and left hand has 8 functions.
- Dimensions: 8" W x 2-7/8" H.

Order No.	Description	List Price	
7-59342	Passenger	\$21.99	FO-9351000
7-59344	Driver with Illuminator	\$23.79	FO-5661000

L.E.D. Waterproof Low Profile Tail Light Kit
Over 80" Wide Trailer



- Multi-LED.
- Sealed, waterproof design.
- Universal mount.
- Hard wired.
- Driver side includes license illuminator.
- Kit includes: (2) LED tail lights, 25' wiring harness, license plate bracket and stainless steel mounting hardware.
- Dimensions: 8-1/16" W x 2-7/8" H.

Order No.	Mfg. No. / Description	List Price	
522501	(TLL16RK) Light Kit	\$93.29	FO-0356000

L.E.D. Waterproof Low Profile Tail Lights
Over 80" Wide Trailer

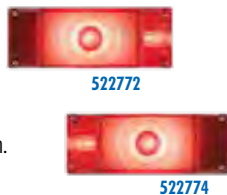

- Single LED.
- Sealed, waterproof design.
- Universal mount.
- Hard wired.
- Driver side includes license illuminator.
- Includes mounting hardware.
- Dimensions: 8" W x 2-7/8" H.

Order No.	Mfg. No. / Description	List Price	
522766	(TLL0016RK) Pair	\$43.49	FO-4403000
522772	(STL0016RBP) Passenger	\$21.79	FO-5251000
522774	(STL0017RBP) Driver	\$23.59	FO-1561000

Submersible Low Profile Trailer Light Kit
Over 80" Wide Trailer



- Incandescent.
- Kit includes: (2) Low profile universal mount tail lights with red side markers/reflectors, 25' wiring harness, 4" trunk connector, license plate bracket, mounting hardware and complete instructions.
- Dimensions: 8" W x 2-7/8" H.

Order No.	Description	List Price	
7-59306	Light Kit	\$35.09	FO-6542000

Submersible Low Profile Tail Lights
Over 80" Wide Trailer



- Incandescent.
- Universal mount.
- Right hand has 7 functions and left hand has 8 functions.
- Dimensions: 8" W x 2-7/8" H.

Order No.	Description	List Price	
7-59304	Passenger	\$9.69	FO-8760000
7-59305	Driver with Illuminator	\$10.09	FO-6070000

- Electronics
- Trolling Motors
- Instruments
- Electrical
- Lighting
- Anchor & Dock
- Safety
- Steering, Controls
- Pumps
- Fuel System
- Seating & Pedestals
- Trailer
- Tops & Covers
- Perform.
- Propellers
- Engine & Care
- Cleaning & Care
- Paint & Paint Acc.
- Fun & Flotation
- Topside Acc.
- Cockpit & Deck
- Hardware, Fasteners
- Camouflage
- Misc.
- Comm.

Waterproof Low Profile Deluxe Trailer Light Kit
Over 80" Wide Trailer



- Incandescent.
- Sealed, waterproof design.
- Universal mount.
- Hard wired.
- Driver side light includes license illuminator.
- Kit includes: (2) Tail lights, (2) yellow marker lights with bases, (2) yellow reflectors, 25' wiring harness, license plate bracket and mounting hardware.
- Dimensions: 8" W x 2-7/8" H.

Order No.	Mfg. No. / Description	List Price	
522954	(TL-16RK) Light Kit	\$48.09	FO-6633000

Waterproof Low Profile Deluxe Trailer Light Kit
Over 80" Wide Trailer



- Incandescent.
- Sealed, waterproof design.
- Universal mount.
- Hard wired.
- Driver side light includes license illuminator.
- Kit includes: (2) Tail lights, 25' wiring harness, license plate bracket and mounting hardware.
- Dimensions: 8" W x 2-7/8" H.

Order No.	Mfg. No. / Description	List Price	
2770136	(TL15RK) Light Kit	\$46.99	FO-9823000

NEW PRODUCT

Waterproof Low Profile Tail Lights
Over 80" Wide Trailer



522967



522955

- Incandescent.
- Sealed, waterproof design.
- Universal mount.
- Hard wired.
- Driver side light includes license illuminator.
- Dimensions: 8" W x 2-7/8" H.

Order No.	Mfg. No. / Description	List Price	
522955	(ST-16RS) Passenger	\$10.69	FO-8470000
522967	(ST-17RS) Driver	\$10.79	FO-5570000
522981	(A16R6) Repl. Lens	\$7.99	HO-9740000

NEW LENS

L.E.D. Waterproof Trailer Light Kit
Over 80" Wide Trailer



- Multi-LED.
- Sealed, waterproof design.
- Universal mount.
- Hard wired.
- Driver side light includes license illuminator.
- Kit includes: (2) LED tail lights, 25' wiring harness, license plate bracket and stainless steel mounting hardware.
- Dimensions: 6-1/16" W x 3-5/8" H.

Order No.	Mfg. No. / Description	List Price	
522820	(TLL56RK) Light Kit	\$106.89	FO-2847000
522830	(STL56RBP) Passenger	\$37.29	FO-0162000
522842	(STL57RBP) Driver	\$45.19	FO-3613000

Low Profile Waterproof Tail Lights
Over 80" Wide Trailer



522972



522970

- Incandescent.
- Waterproof design.
- Mount on 2" centers.
- Includes separate ground wire with eyelet.
- Driver side light includes license illuminator.
- Dimensions: 7-7/8" W x 3-1/4" H.

Order No.	Mfg. No. / Description	List Price	
522970	(ST36RS) Passenger	\$15.09	FO-6501000
522972	(ST37RS) Driver	\$15.59	FO-1901000
522448	(A36R) Repl. Lens	\$6.99	HO-9140000

NEW LENS

Submersible Tail Lights
Over 80" Wide Trailer



684763



684775

- Incandescent.
- Waterproof design.
- Mount on 2" centers.
- Includes separate ground wire with eyelet.
- Driver side light includes license illuminator.
- Dimensions: 6-1/16" W x 3-3/4" H.

Order No.	Mfg. No. / Description	List Price	
684775	(ST56RS) Passenger	\$11.59	FO-1180000
684763	(ST57RS) Driver	\$11.79	FO-5280000

L.E.D. 6" Sealed Oval Tail Lights



7-59362



7-59419

- Multi-LED.
- Includes: Grommet and wire plug.

Order No.	Description	List Price	
7-59362	Red Tail Light	\$20.29	FO-0241000
7-59419	White Tail Light	\$27.29	FO-0191000

L.E.D. 6" Sealed Oval Tail Light Kit



- Single LED.
- Sonically sealed, waterproof.
- Mount in any 360° position.
- Grommet mount.
- Kit includes: (2) LED tail lights, grommets and 3-pin straight pigtailed with 10" leads.
- Dimensions: 6-1/2" W x 2-1/4" H.

Order No.	Mfg. No. / Description	List Price	
522741	(TLL002RK) Light Kit	\$26.09	FO-6281000
522776	(STL002RBP) Module	\$11.99	FO-9380000

6" Sealed Oval Tail Lights



7-59307



7-59314

- Incandescent.
- Includes: Grommet and wire plug.

Order No.	Description	List Price	
7-59307	Red Tail Light	\$8.59	FO-1060000
7-59308	Red Module Only	\$6.19	FO-3340000
7-59314	Clear Module Only	\$6.89	FO-2840000

6" Sealed Oval Tail Light



- Incandescent.
- Sonically sealed, waterproof.
- Includes grommet and 3-pin straight pigtail with 10" leads.
- Dimensions: 6-1/2" W x 2-5/16" H.

Order No.	Mfg. No. / Description	List Price	
522993	(ST70RK) Red Tail Light	\$10.19	FO-3170000
523008	(ST70RS) Module Only	\$6.99	FO-9840000

6" Oval Mounting Grommet



- PVC grommet for flush mount.
- Provide shock mount to lengthen life of light.

Order No.	Mfg. No. / Description	List Price	
523010	(A70GBP)	\$1.99	FO-9310000

- Electronics
- Trolling Motors
- Instruments
- Electrical
- Lighting
- Anchor & Dock
- Safety
- Steering, Controls
- Pumps
- Fuel System
- Seating & Pedestals
- Trailer
- Tops & Covers
- Perform.
- Propellers
- Engine & Care
- Cleaning & Care
- Paint & Paint Acc.
- Fun & Flotation
- Topside Acc.
- Cockpit & Deck
- Hardware, Fasteners
- Camouflage
- Misc.
- Comm.

- Electronics
- Trolling Motors
- Instruments
- Electrical
- Lighting
- Anchor & Dock
- Safety
- Steering, Controls
- Pumps
- Fuel System
- Seating & Pedestals
- Trailer
- Tops & Covers
- Perform.
- Propellers
- Engine & Care
- Cleaning & Care
- Paint & Paint Acc.
- Fun & Flotation
- Topside Acc.
- Cockpit & Deck
- Hardware, Fasteners
- Camouflage
- Misc.
- Comm.

L.E.D. 4" Round Recessed Tail Light

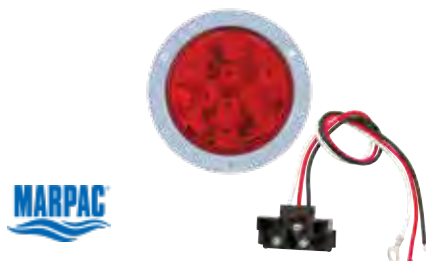

- Multi-LED.
- Sonically sealed for waterproof.
- Epoxy encapsulated electronics.
- Flange mount.

Order No.	Description	List Price	
7-59361	LED Trailer Light	\$19.99	FO-9931000

L.E.D. 4" Sealed Round Tail Light Kit



- Single LED.
- Sonically sealed, waterproof.
- Mount in any 360° position.
- Grommet mount.
- Kit includes: LED tail light, grommet and 3-pin straight pigtail with 10" leads.

Order No.	Mfg. No. / Description	List Price	
522715	(STL003RK) Light Kit	\$15.09	FO-6501000
522703	(STL003RBP) Module	\$11.99	FO-9380000

4" Sealed Round Tail Light



- Incandescent.
- Sonically sealed, waterproof.
- Red.
- Kit includes: Tail light, grommet and 3-pin straight pigtail with 10" lead.

Order No.	Mfg. No. / Description	List Price	
522652	(ST45RK) Light Kit	\$12.29	FO-0680000
522690	(ST45RS) Module Only	\$7.49	FO-4250000

4" Round Mounting Grommet



- PVC grommet for flush mount.
- Provide shock mount to lengthen life of light.

Order No.	Mfg. No. / Description	List Price	
522688	(A45GB)	\$1.39	FO-7900000

L.E.D. Marker/Clearance Lights



- Single LED.
- Snap-in module with chrome base.
- Includes: Rubber grommet and stainless steel screws.
- Surface mount.
- Dimensions: 2-7/8" x 1-1/2".

Order No.	Description	List Price	
7-0070	Amber	\$5.89	FO-2140000
7-0071	Red	\$5.89	FO-2140000

L.E.D. Sealed Marker/Clearance Lights



- Three LEDs.
- Sonically sealed, waterproof.
- Self-grounding.
- Includes: Chrome base and single wire pigtail.
- Surface mount.
- Dimensions: 2-1/2" x 1-3/16".

Order No.	Mfg. No. / Description	List Price	
522882	(MCL91AK) Amber	\$11.89	HO-3170000
522884	(MCL91RK) Red	\$12.89	HO-3770000

L.E.D. Waterproof Marker/Clearance Lights



- Two LEDs.
- One piece design with thru-lens mounting holes.
- Includes: Chrome base and two 18" wire construction.
- Surface mount.
- Dimensions: 2.6" x 1.1".

Order No.	Mfg. No. / Description	List Price	
3842093	(54201-002) Red	\$15.99	G1-9301000

L.E.D. Marker/Clearance Lights



- Three LEDs.
- Waterproof. Ear mount.
- Stainless steel screws.
- Dimensions: 3-1/8" x 1".

Order No.	Description	List Price	
7-59310	Amber	\$5.69	FO-8930000
7-59311	Red	\$5.69	FO-8930000

L.E.D. Sleek Accent Marker/Clearance Lights



- Two LEDs.
- Sleek design for an updated look.
- Vibrant illumination.
- Chrome bezel.
- Dimensions: 3-7/8" x 1-3/8".

Order No.	Description	List Price	
7-59365	Amber	\$7.59	FO-1350000
7-59366	Red	\$7.99	FO-9550000

Marker/Clearance Lights



- Incandescent.
- Snap-in module with choice of chrome or black base.
- Single wire.
- Includes: Rubber grommet and stainless steel screws.
- Surface mount.
- Dimensions: 2-7/8" x 1-1/2".

Order No.	Description	List Price	
7-59270	Marker Light Amber	\$5.49	FO-4830000
7-59271	Marker Light Red	\$5.49	FO-4830000
7-59272	Module Only Amber	\$4.39	FO-7030000
7-59273	Module Only Red	\$4.39	FO-7030000

Sealed Marker/Clearance Lights

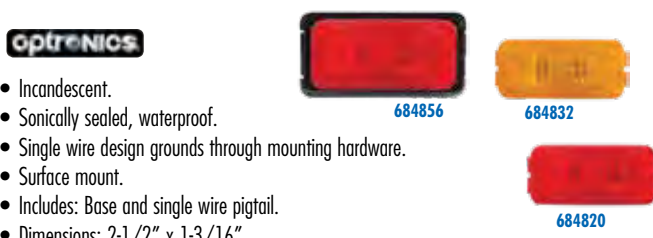

- Incandescent.
- Sonically sealed, waterproof.
- Single wire design grounds through mounting hardware.
- Surface mount.
- Includes: Base and single wire pigtail.
- Dimensions: 2-1/2" x 1-3/16".

Order No.	Mfg. No. / Description	List Price	
AMBER			
522878	(MC91AS) Chrome Base	\$5.79	HO-7430000
684832	(MC90AS) Module Only	\$3.89	HO-3320000
RED			
684856	(MC92RS) Black Base	\$5.99	HO-9530000
522880	(MC91RS) Chrome Base	\$4.39	FO-7030000
684820	(MC90RS) Module Only	\$3.89	HO-3320000

L.E.D. Submersible Marker/Clearance Lights



- Multi-LED.
- Single wire.
- Black base.
- Stud mount acts as ground.
- Dimensions: 2-13/16" x 2-1/8".

Order No.	Description	List Price	
7-59312	Amber	\$6.99	FO-9840000
7-59313	Red	\$6.99	FO-9840000

L.E.D. Waterproof Marker/Clearance Light with Reflex



- Six LEDs.
- Waterproof.
- Stud mount.
- Black base and two-wire design.
- Dimensions: 2-7/8" x 2-1/8".

Order No.	Mfg. No. / Description	List Price	
522208	(MCL36AS) Yellow	\$12.39	HO-3470000



Mini L.E.D. Marker/Clearance Light



- Three LEDs.
- Single wire.
- Chrome base.
- Stud mount acts as ground.
- Dimensions: 2-1/8" x 1-1/8".

Order No.	Description	List Price	
7-59274	Amber	\$7.29	FO-0150000

Mini L.E.D. Sealed Marker/Clearance Lights



- Three LEDs.
- Sonically sealed, waterproof.
- Stud mount.
- Self-grounding.
- Includes: Stainless steel base and single wire pigtail.
- Dimensions: 2-1/8" x 1-1/8".

Order No.	Mfg. No. / Description	List Price	
522892	(MCL95AS) Yellow	\$10.19	FO-3170000
522894	(MCL95RS) Red	\$10.19	FO-3170000

Marker/Clearance Lights



- Incandescent.
- Black base.
- Stud mount acts as ground.
- Dimensions: 2-13/16" x 2-1/8".

Order No.	Description	List Price	
7-59217	Amber	\$4.29	GO-7820000
7-59218	Red	\$3.99	GO-7620000



Marker/Clearance Lights with Reflex



- Incandescent.
- Lens with reflex eliminates need for separate reflector.
- Black base and single wire design.
- Stud mount.
- Dimensions: 2-3/4" x 2-1/8".

Order No.	Mfg. No. / Description	List Price	
522854	(MC-36AS) Yellow	\$5.79	HO-7430000

Mini Marker/Clearance Lights



- Incandescent.
- Stainless steel base.
- Stud mount.

Order No.	Description	List Price	
7-59247	Amber	\$4.09	FO-6820000
7-59248	Red	\$4.09	FO-6820000

Mini Sealed Marker/Clearance Lights



- Incandescent.
- Sonically sealed, waterproof.
- Self-grounding.
- Includes: Stainless steel base and single wire pigtail.
- Stud mount.
- Dimensions: 2-1/16" x 1 11/16".

Order No.	Mfg. No. / Description	List Price	
522888	(MC95RS) Red	\$4.19	FO-3920000
522889	(MC95AS) Yellow	\$5.09	HO-5030000

Mini L.E.D. Marker/Clearance Lights



- Single LED.
- Snap-in module with rubber grommet or chrome base.
- Two wire.
- Diameter 3/4".

Order No.	Description	List Price	
7-59278	Amber	\$5.39	FO-7730000
7-59279	Red	\$5.39	FO-7730000

Mini L.E.D. Sealed Marker/Clearance Lights



- Single LED.
- Sonically sealed, waterproof.
- Includes: Single wire pigtail & grommet.
- Grommet mount.
- Round: 3/4".

Order No.	Mfg. No. / Description	List Price	
2770035	(MCL12AK) Yellow	\$9.99	HO-9950000
2770036	(MCL12RK) Red	\$8.99	HO-9350000

L.E.D. Trailer ID Light Bar



- Three LEDs.
- For over 80" trailers.
- Durable, corrosion proof base.
- Dimensions: 17" L x 1-1/2" W x 1-3/4" H.

Order No.	Description	List Price	
7-59352	LED Trailer ID Light Bar	\$17.89	FO-2521000

L.E.D. Trailer ID Light Bar



- Three LEDs.
- For over 80" trailers.
- Stainless steel base.
- Dimensions: 14-1/4" L x 1-1/8" W x 1-1/8" H.

Order No.	Description	List Price	
7-59260	LED Trailer ID Light Bar	\$18.49	FO-4921000

L.E.D. Sealed Trailer ID Light Bar



- Nine LEDs.
- For over 80" trailers.
- Self-grounding. Single wire pigtail.
- Corrosion proof polycarbonatel base. Surface mount on 7-1/2" centers.
- Dimensions: 15-15/16" L x 1-15/32" W x 1-5/8" H.

Order No.	Mfg. No. / Description	List Price	
2770134	(MCL93RBP)	\$31.79	HO-7091000



L.E.D. Sealed Trailer ID Light Bar

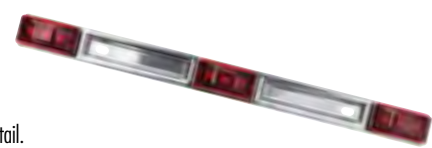

- Three LEDs.
- For over 80" trailers.
- Self-grounding. Single wire pigtail.
- Stainless steel base. Surface mount on 8-1/2" centers.
- Dimensions: 14-1/4" L x 1-3/16" W x 1-1/8" H.

Order No.	Mfg. No. / Description	List Price	
522886	(MCL-97RK)	\$31.29	FO-0912000

- Electronics
- Trolling Motors
- Instruments
- Electrical
- Lighting
- Anchor & Dock
- Safety
- Steering, Controls
- Pumps
- Fuel System
- Seating & Pedestals
- Trailer
- Tops & Covers
- Perform.
- Propellers
- Engine & Care
- Cleaning & Care
- Paint & Paint Acc.
- Fun & Flotation
- Topside Acc.
- Cockpit & Deck
- Hardware, Fasteners
- Camouflage
- Misc.
- Comm.

Trailer ID Light Bar



- Incandescent.
- For over 80" trailers.
- Durable, corrosion proof base.
- Dimensions: 17" L x 1-1/2" W x 1-3/4" H.

Order No.	Description	List Price	
7-59249	Trailer ID Light Bar	\$12.59	FO-1880000

Trailer ID Light Bar



- Incandescent.
- For over 80" trailers.
- Stainless steel base.
- Dimensions: 14-1/4" L x 1-1/8" W x 1-1/8" H.

Order No.	Description	List Price	
7-59261	Trailer ID Light Bar	\$13.49	FO-4490000

LIMITED QUANTITIES

Sealed Trailer ID Light Bar



- Incandescent.
- For over 80" trailers.
- Sonically sealed, waterproof.
- Self-grounding. Single wire pigtail. Stainless steel base.
- Surface mount on 8-1/2" centers.
- Dimensions: 14-1/4" L x 1-3/16" W x 1-1/8" H.

Order No.	Mfg. No. / Description	List Price	
522890	(MC-97RK)	\$15.69	FO-8901000

Stick-On Reflectors



- DOT approved stick-on reflectors.

Order No.	Description	Dimensions	List Price	
7-59320	Amber	1-1/2" x 3"	\$2.99	FO-9020000
7-59323	Red	1-1/2" x 3"	\$3.29	FO-0320000
1-59321	Amber	3" Round	\$3.49	HO-9020000
1-59322	Red	3" Round	\$3.49	HO-9020000

Reflective Tape Strips



- Dot-C2 Approved. (2) 2" x 12" strips.

Order No.	Description	List Price	
7-59325	Reflective Tape Strips	\$3.09	FO-6120000

4-Way Flat Trailer and Vehicle Connectors



- Color-coded 4-way wires.
- 12 and 24 volt capacity.

Order No.	Description	List Price	
7-0525	Trailer Connector with Male Plug and 12" Wiring	\$5.69	FO-8930000
7-0526	Vehicle Connector with Female Plug and 48" Wiring	\$9.59	FO-1760000

5-Way Flat Trailer and Vehicle Connectors

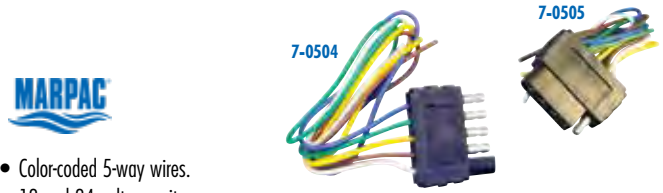

- Color-coded 5-way wires.
- 12 and 24 volt capacity.

Order No.	Description	List Price	
7-0504	Trailer Connector with Male Plug and 12" Wiring	\$6.79	FO-5740000
7-0505	Vehicle Connector with Female Plug and 48" Wiring	\$11.99	FO-9380000

4-Way Flat Car End Harness



- Car end.
- Length 48" with 18" ground.
- Color coded harness.

Order No.	Mfg. No. / Description	List Price	
685327	(707275)	\$9.39	HO-3650000

LIMITED QUANTITIES

4-Way Trunk Connector



- Length 48".

Order No.	Mfg. No. / Description	List Price	
685303	(A48TC)	\$6.39	FO-7440000

4-Wire Quick Connector

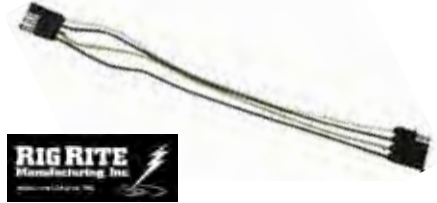

- Use as an extension or jumper from trailer to vehicle.
- Can be cut in half to replace trunk and trailer connector.
- 16-gauge wire, 12" long.

Order No.	Mfg. No. / Description	List Price	
2970810	(810)	\$15.19	G1-7890000

4-Way Trailer Test Plug with Cap

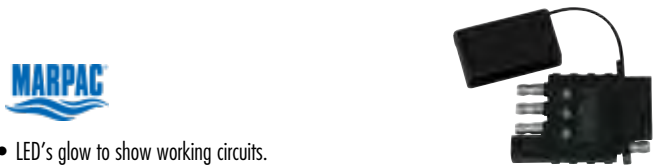

- LED's glow to show working circuits.
- Checks brake, tail and turn lights.

Order No.	Description	List Price	
7-0503	4-Way Trailer Test Plug	\$4.79	FO-5330000

4-Way Circuit Tester

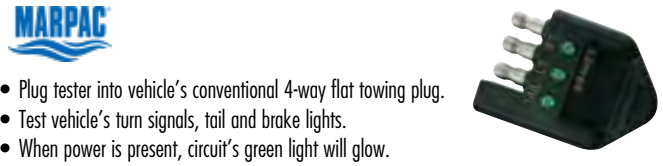

- Plug tester into vehicle's conventional 4-way flat towing plug.
- Test vehicle's turn signals, tail and brake lights.
- When power is present, circuit's green light will glow.
- Waterproof PVC material.

Order No.	Description	List Price	
7-59390	4-Way Circuit Tester	\$3.29	FO-0320000

- Electronics
- Trolling Motors
- Instruments
- Electrical
- Lighting
- Anchor & Dock
- Safety
- Steering, Controls
- Pumps
- Fuel System
- Seating & Pedestals
- Trailer
- Tops & Covers
- Perform.
- Propellers
- Engine & Care
- Cleaning & Care
- Paint & Paint Acc.
- Fun & Flotation
- Topside Acc.
- Cockpit & Deck
- Hardware, Fasteners
- Camouflage
- Misc.
- Comm.

4-Way Trailer Wiring Kit



- Includes: Trailer and vehicle connectors, (8) trailer clips and (4) wire connectors.
- Color-coded 4-way wires.
- Length 25'.



Order No.	Description	List Price	
7-59372	4-Way Trailer Wiring Kit	\$19.49	FO-4631000

5-Way Trailer Wiring Kit



- Includes: Trailer and vehicle connectors, (8) trailer clips and (2) wire connectors.
- Color-coded 5-way wires.
- Length 40'.



Order No.	Description	List Price	
7-59437	5-Way Trailer Wiring Kit	\$33.99	GO-7722000

4-Way Wishbone Style Wiring Harness



- 25' 4-way harness with 4' trunk connector.

Order No.	Mfg. No. / Description	List Price	
685529	(A25WH)	\$17.79	FO-5421000

5-Way Wishbone Style Wiring Harness



- 25' 5-way harness with 4' trunk connector.

Order No.	Mfg. No. / Description	List Price	
523295	(A-255WH3)	\$20.69	FO-8441000

Trailer Extension Harnesses



- Color-coded 4-way and 5-way extension harness.
- Includes: Male and female ends.
- Use as an extension or cut to length for wired connectors.

Order No.	Description	List Price	
7-59379	4-Way, Length 1'	\$5.19	FO-3630000
7-59380	4-Way, Length 2'	\$8.69	FO-8060000
7-59386	5-Way, Length 2'	\$9.69	FO-8760000

7-Round to 5-Flat Trailer Adapters



- One piece adapter.
- 7-way round to 5-way flat.

Order No.	Description	List Price	
7-0507	Adapter	\$10.19	FO-3170000
7-0527	Adapter - Length 16"	\$14.09	FO-6890000

7-Round to 5-Flat Trailer Adapter



- 7-way round to 5-way flat.
- Length 16".

Order No.	Mfg. No. / Description	List Price	
523159	(A57WH)	\$13.39	FO-7390000

7-Round to 5-Flat Coiled Trailer Adapter



- Coiled extension.
- 7-way round to 5-way flat.
- Length 26" to 48".

Order No.	Description	List Price	
7-59263	Adapter	\$39.99	FO-9972000

7-Round to 5-Flat Trailer Adapter



- Black plastic construction.
- 7-round to 5-flat trailer wire adapter.

Order No.	Description	List Price	
7-59396	Adapter	\$14.29	FO-0001000

LIMITED QUANTITIES

7-Round to 5-Flat Trailer Adapter



- 7-way round to 5-flat.
- Single piece.

Order No.	Mfg. No. / Description	List Price	
522915	(A75TC6)	\$14.09	FO-1520000

7-Round to 4-Flat Trailer Adapter



- One piece adapter.
- 7-way round to 4-flat.

Order No.	Description	List Price	
7-0506	Adapter	\$10.09	FO-6070000

- Electronics
- Trolling Motors
- Instruments
- Electrical
- Lighting
- Anchor & Dock
- Safety
- Steering, Controls
- Pumps
- Fuel System
- Seating & Pedestals
- Trailer
- Tops & Covers
- Perform.
- Propellers
- Engine & Care
- Cleaning & Care
- Paint & Paint Acc.
- Fun & Flotation
- Topside Acc.
- Cockpit & Deck
- Hardware, Fasteners
- Camouflage
- Misc.
- Comm.

Galvanized License Plate Bracket



- Standard license plate bracket.
- 2" hole centers.

Order No.	Description	List Price	
7-59101	License Plate Bracket	\$6.39	FO-7440000

License Plate Mounting Bracket



- Made of heavy duty aluminum treadbrite material.
- Multiple hole placement provides universal mounting options.

Order No.	Mfg. No. / Description	List Price	
578376	(86565)	\$12.39	HO-3470000

Polyethylene License Plate Bracket



- Standard license plate bracket.
- 2" hole centers.

Order No.	Description	List Price	
7-59102	License Plate Bracket	\$1.89	FO-2310000

Rust Proof License Plate Bracket



- Angled license plate bracket, made of rust proof black polymer.
- Accept stud mount license plate lights.

Order No.	Mfg. No. / Description	List Price	
685098	(LP-10S)	\$3.59	FO-1520000

License Plate Bracket



- Universal slotted mount.
- Quick and easy installation.
- Rust and corrosion proof.

Order No.	Description	List Price	
7-59098	License Plate Bracket	\$1.79	FO-5210000

Universal Tail Light Bracket



- Made from heavy duty 7 gauge steel and is hot dip galvanized for long lasting protection.

Order No.	Mfg. No. / Description	List Price	
578378	(86566)	\$6.89	HO-3140000

Tail Light Protector



- Designed to provide additional protection for the tail light.
- There is no hardware required for installation, the Protector is designed to mount between the existing tail light bracket and the light.

LIMITED QUANTITIES

Order No.	Mfg. No. / Description	List Price	
578372	(86573)	\$14.39	FO-7001000

Trailer Wire Frame Clips



- Zinc plated.
- Corrosion resistant.
- Secures and organizes trailer wire along the trailer frame.
- Sold 10 per pack.

Order No.	Description	List Price	
7-59289	Trailer Wire Frame Clips	\$2.79	FO-5910000

Medium Strength Frame Clips



- Frame clips can be used to hide or keep wires and wire harness in place and away from potential damage.
- Sold 10 pieces per pack.

Order No.	Mfg. No. / Description	List Price	
223975	(A-12FC)	\$2.29	HO-7310000

Poly Keel Rollers



- Non-marring poly blend with UV inhibitors.
- Shaft diameter 5/8".

Order No.	Description	List Price	
7-1580	Length 8"	\$21.09	FO-6741000
7-1581	Length 10"	\$22.59	FO-1851000
7-1582	Length 12"	\$27.69	FO-8391000

12" Self-Centering Poly Keel Roller



- Non-marring poly blend with UV inhibitors.
- Molded grooves center boat as it moves forward for easier loading.
- Replaces any 12" roller.
- Shaft diameter 5/8".

Order No.	Description	List Price	
7-1583	Keel Roller	\$25.79	FO-5081000

Poly Spool Rollers



- Non-marring poly blend with UV inhibitors.
- Shaft diameter 5/8".

Order No.	Description	List Price	
7-1570	Length 3-1/2"	\$6.79	FO-5740000
7-1571	Length 4-1/2"	\$7.99	FO-9550000

Poly Wobble Roller



- Non-marring poly blend with UV inhibitors.
- Shaft diameter 3/4".
- Diameter 4". Width 3".

Order No.	Description	List Price	
7-1575	Wobble Roller	\$11.19	FO-3870000

Poly Bow Stop Rollers



- Non-marring poly blend with UV inhibitors.
- Shaft diameter 1/2".

Order No.	Description	List Price	
7-1566	Width 3"	\$6.99	FO-9840000
7-1567	Width 4"	\$8.49	FO-4950000

Poly Bell Stop Assemblies



- Non-marring poly blend with UV inhibitors.
- Stainless steel hardware.

Order No.	Description	List Price	
7-1560	Width 3"	\$22.89	GO-4351000
7-1561	Width 4"	\$30.39	GO-6302000

Poly V-Bow Stop

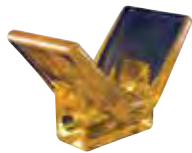

- Non-marring poly blend with UV inhibitors.
- Shaft diameter 1/2".
- Length 3".

Order No.	Description	List Price	FO-4250000
7-1565	V-Bow Stop	\$7.49	

Wobble Roller



- Black rubber.
- Thread with sleeve.
- Width 3".
- Shaft diameter 1/2".

Order No.	Description	List Price	FO-0150000
7-1882	Wobble Roller	\$7.29	

Bow Stop Rollers



- Black rubber.
- Shaft diameter 1/2".
- Typically used in trailer winch stand application as bow stop.

Order No.	Length	Diameter	List Price	FO-4830000
7-1877	3"	3"	\$5.49	
7-59507	4"	3-3/8"	\$8.79	FO-5160000

Keel Rollers



- Black rubber with nylon bushing.
- Supports the guidance of a boat when launching and retrieving.
- Shaft diameter 5/8".
- Maximum roller OD 3-1/2".

Order No.	Description	List Price	FO-2401000
7-1870	Length 8"	\$14.89	
7-1871	Length 10"	\$18.89	FO-2231000
7-1872	Length 12"	\$23.49	FO-4461000

Spool Rollers



- Black rubber with nylon bushing.
- Designed especially to support the keel of lighter boats.
- Diameter 3".

Order No.	Length	Shaft Diameter	List Price	FO-4540000
7-59508	4"	1/2"	\$6.49	
7-1874	4"	5/8"	\$6.29	FO-0440000
7-1873	5"	1/2"	\$7.59	FO-1350000
7-1875	5"	5/8"	\$7.59	FO-1350000

V-Bow Stop



- Black rubber.
- Shaft diameter 1/2".
- Typically used in trailer winch stand application as bow stop.

Order No.	Description	List Price	FO-4830000
7-1878	Base Dia. 2" x 2-1/8" Top Dia. 2" x 2-3/8"	\$5.49	
7-1880	Base Dia. 3" x 3" Top Dia. 3" x 4-7/8"	\$8.49	FO-4950000
7-1879	Base Dia. 3-7/8" x 4" Top Dia. 4" x 6-7/8"	\$11.39	FO-7970000

Shaft Spool/Bow Stop Roller End Caps



- Durable black rubber end cap.

Order No.	Description	Shaft Diameter	List Price	FO-0610000
7-59523	Diameter 2"	1/2"	\$2.29	
7-59524	Diameter 2-1/2"	5/8"	\$2.59	FO-1810000
7-59528	Diameter 3"	1/2"	\$2.59	FO-1810000
7-59522	Diameter 3-1/2"	5/8"	\$3.19	FO-3220000

Side Guide Rollers



- Black rubber.
- Helps center boat in non-drive-on applications.
- Prevents boat from damaging trailer fenders and light brackets.

Order No.	Length	Diameter	Shaft Diameter	List Price	FO-5280000
7-59514	9"	2"	1/2"	\$11.79	
7-1883	12"	2-1/2"	5/8"	\$13.39	FO-7390000

Black PVC Keel Rollers



- Made of a high quality, poly-vinyl material that is cut and fade resistant.
- Shaft diameter 5/8".

Order No.	Mfg. No. / Description	List Price	HO-1391000
3566409	(86409) Length 8"	\$32.19	
3566410	(86410) Length 10"	\$37.89	HO-3722000

Black PVC Wobble Roller - Smooth



- Made of a high quality, poly-vinyl material that is cut and fade resistant.
- Shaft diameter 3/4".

Order No.	Mfg. No. / Description	List Price	HO-1241000
M804-86492	(86492) Length 4"	\$23.69	

LIMITED QUANTITIES

Amber PVC Bow Roller Assemblies



- Made of a high quality, poly-vinyl material that is cut and fade resistant.
- With end bells.
- Shaft diameter 1/2".

Order No.	Mfg. No. / Description	List Price	LO-5571000
3566143	(86143) Length 3"	\$35.09	
3566142	(86142) Length 4"	\$37.79	LO-0981000

Amber PVC Keel Pad



- Made of a high quality, poly-vinyl material that is cut and fade resistant.
- Diameter 3-1/2" x 15".

Order No.	Mfg. No. / Description	List Price	LO-0580000
3568650	(86291)	\$16.99	

- Electronics
- Trolling Motors
- Instruments
- Electrical
- Lighting
- Anchor & Dock
- Safety
- Steering, Controls
- Pumps
- Fuel System
- Seating & Pedestals
- Trailering
- Tops & Covers
- Perform.
- Propellers
- Engine & Care
- Cleaning & Care
- Paint & Paint Acc.
- Fun & Flotation
- Topside Acc.
- Cockpit & Deck
- Hardware, Fasteners
- Camouflage
- Misc.
- Comm.

Wobble Roller Kits



- 5" wobble roller kit.
- 7/8" and 1-1/8" shafts.

Order No.	Mfg. No. / Description	List Price	
5765080	(86144) Amber Rollers	\$73.09	F0-6115000
5765082	(86419) Black Rollers	\$69.59	F0-1784000

Wobble Roller Front Assembly



- The front assembly is designed to mount only one wobble roller wing set.
- The design features 2" of height adjust-ability and can fit onto either 3x3 or 3x4 cross-members.
- The assembly comes with wobble rollers and hardware.

Order No.	Mfg. No. / Description	List Price	
5765079	(86574)	\$120.79	F0-5548000

Wobble Roller Assembly - Single



- Includes (4) wobble rollers per pair.
- Mounts to cross members up to 3" x 5".
- 2-1/2" sq. tube is 14 gauge.
- The distance from top of trailer frame to top of the rollers is 7-5/8" on the lower adjustment and 8-3/4" at the top adjustment.
- Roller assemblies (2 ea. wobble rollers on shaft) have an outside to outside width of 14".
- Packaged one pair per carton with all mounting hardware.

Order No.	Mfg. No. / Description	List Price	
3750982	(T-982)	\$129.99	F0-9909000

Wobble Roller Assembly - Pair

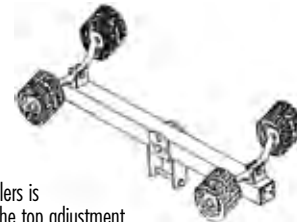

- Includes (8) wobble rollers per pair.
- Mounts to cross members up to 3" x 5".
- 2" sq. x 14 gauge tube is 28" long.
- The distance from top of trailer frame to top of rollers is 7-5/8" on the lower adjustment and 8-3/4" at the top adjustment.
- Roller assemblies (2 ea. wobble rollers on shaft) have an outside to outside width of 14".
- Packaged one pair per carton with all mounting hardware.

Order No.	Mfg. No. / Description	List Price	
3750980	(T-980)	\$280.09	F0-6069100

Heavy-Duty Wobble Roller Assembly - Pair

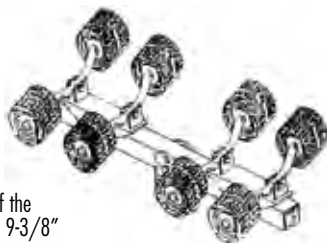

- Includes (16) wobble rollers per pair.
- Mounts to cross members up to 3" x 5".
- 2" sq. x 11 gauge tube is 28" long.
- The distance from top of trailer frame to top of the rollers is 8-1/4" on the lower adjustment and 9-3/8" at the top adjustment.
- Roller assemblies (2 ea. wobble rollers on shaft) have an outside to outside width of 14".
- Packaged one pair per carton with all mounting hardware.

Order No.	Mfg. No. / Description	List Price	
3750988	(T-988)	\$445.09	F0-6511300

Bow V-Roller Assembly



- 2" x 3" x 12" x 1/4" aluminum angle pre-drilled mounting brackets to be used with 3-1/8" u-bolts.
- 1-1/4" schedule 40 aluminum tube v-bracket with 1-1/2" schedule 40 PVC.
- 12" pvc keel roller with 13-1/2" galvanized roller shaft.
- Fully assembled.

Order No.	Description	List Price	
7-1564	Bow V-Roller Assembly	\$183.09	G0-7622100

Galvanized Roller Shafts



- Galvanized for corrosion resistance.
- No pal nuts required.
- Includes: (2) zinc plated washers and stainless steel cotter pin.

Order No.	Description	List Price	
7-1835	1/2" OD Length 5-1/4" Fits 4" Roller	\$3.09	F0-6120000
7-1836	1/2" OD Length 6-1/4" Fits 5" Roller	\$3.79	F0-5620000
7-1837	5/8" OD Length 5-1/4" Fits 4" Roller	\$4.39	F0-7030000
7-1838	5/8" OD Length 6-1/4" Fits 5" Roller	\$4.49	F0-4130000
7-1839	5/8" OD Length 9-1/4" Fits 8" Roller	\$5.59	F0-1930000
7-1840	5/8" OD Length 11-1/4" Fits 10" Roller	\$6.09	F0-6240000
7-1841	5/8" OD Length 13-1/4" Fits 12" Roller	\$7.19	F0-3050000

Roller Shafts



- Zinc plated.
- Includes roller shaft and 2 pal/cap nuts.

Order No.	Mfg. No. / Description	List Price	
576857	(86025) Length 5-1/4" Diameter 1/2"	\$7.89	F0-2550000
576869	(86026) Length 6-1/4" Diameter 1/2"	\$7.39	F0-7150000
576871	(86027) Length 5-1/4" Diameter 5/8"	\$8.39	F0-7850000
576883	(86028) Length 6-1/4" Diameter 5/8"	\$8.99	F0-9260000
576895	(86029) Length 9-1/4" Diameter 5/8"	\$9.99	F0-9960000
576908	(86030) Length 11-1/4" Diameter 5/8"	\$10.89	F0-2670000
5765128	(86032) Length 15-1/4" Diameter 5/8"	\$10.19	F0-3170000
5765129	(86033) Length 19-1/4" Diameter 5/8"	\$12.19	F0-3580000

Pal/Cap Nuts



- Press on to secure shaft to roller bracket.
- Sold 4 per pack.

Order No.	Mfg. No. / Description	List Price	
576958	(86305) 1/2" OD	\$5.19	F0-3630000
576960	(86310) 5/8" OD	\$5.49	F0-4830000

Electronics

Trolling Motors

Instruments

Electrical

Lighting

Anchor & Dock

Safety

Steering, Controls

Pumps

Fuel System

Seating & Pedestals

Trailering

Tops & Covers

Perform.

Propellers

Engine & Care

Cleaning & Care

Paint & Paint Acc.

Fun & Flotation

Topside Acc.

Cockpit & Deck

Hardware, Fasteners

Camouflage

Misc.

Comm.

Galvanized Panel Brackets



- Heavy 11 gauge hot dipped galvanized steel.
- One piece and designed to support keel rollers.
- Slots accept 7/16" or 1/2" diameter bolts and provide vertical roller adjustment.



Order No.	Description	List Price	Mfg. No. / Description
7-1829	Fits 4" Roller	\$10.89	F0-2670000
7-1830	Fits 5" Roller	\$11.49	F0-4080000
7-1831	Fits 8" Roller	\$13.59	F0-1590000
7-1832	Fits 10" Roller	\$13.59	F0-1590000
7-1833	Fits 12" Roller	\$16.69	F0-8611000

Panel Brackets



- Specifically designed for use with keel rollers.
- Brackets are made of 11 gauge steel, hot dip galvanized for lasting protection.
- Slots accept 7/16" or 1/2" diameter bolts and provide vertical roller adjustment while roller shaft diameters can be 1/2" or 5/8".



Order No.	Mfg. No. / Description	Bracket Width:	List Price	Mfg. No. / Description
576782	(86152) For 8" Roller	8-3/8"	\$19.09	F0-6331000
576794	(86155) For 10" Roller	10-3/8"	\$20.59	F0-1441000
576807	(86153) For 12" Roller	12-3/8"	\$23.49	F0-4461000

Split Panel Bracket



- Hot dip galvanized.
- Slots allow vertical adjustment for stabilizing the boat on trailer.
- Slots accept 7/16" or 1/2" diameter bolts.
- Roller shaft diameter can be 1/2" or 5/8" roller shaft.
- Sold in pairs (left and right).



Order No.	Mfg. No. / Description	List Price	Mfg. No. / Description
487581	(81235)	\$20.79	F0-5541000

Bolster Brackets



- Hot dip galvanized.
- Designed to support bunk boards.
- Slotted for vertical adjustment and feature non-slip dimples to avoid movement and increase load capacity.
- Slot: 1-1/16".
- Sold in pairs.



Order No.	Mfg. No. / Description	List Price	Mfg. No. / Description
5765095	(81195) Length 8"	\$14.49	F0-4101000

Galvanized Bolster Brackets



- Heavy 11 gauge hot dipped galvanized steel.
- Slotted for vertical adjustment and feature nonslip dimples to avoid movement and increase load capacity.
- Sold 2 per package with swivel brackets.



Order No.	Description	Slot Length	List Price	Mfg. No. / Description
7-1820	Length 8"	2-3/4"	\$17.59	F0-1321000
7-1821	Length 10"	3-3/4"	\$19.89	F0-2931000
7-1822	Length 12"	4-3/4"	\$22.49	F0-4751000
7-1825	Swivel Brackets - Sold 2 Per Package		\$4.19	F0-3920000

Bolster Swivel Brackets



- Hot dip galvanized.
- Designed to support bunk boards.
- Slotted for vertical adjustment and feature non-slip dimples to avoid movement and increase load capacity.
- Slot length: 1-1/16".
- Packaged in pairs including swivel brackets, bolts and nyloc nuts.



Order No.	Mfg. No. / Description	List Price	Mfg. No. / Description
5765099	(81210) Length 8"	\$16.99	F0-9811000
5765100	(81215) Length 10"	\$21.09	F0-6741000
5765101	(81220) Length 12"	\$24.49	F0-4171000

Swivel Brackets



- Hot dip galvanized.
- Designed to allow for a slight degree of swiveling or shifting, accommodating the movement of the bunk boards.
- The 2 pack includes: 1/2" x 1" bolt and (2) nyloc nuts.



Order No.	Mfg. No. / Description	List Price	Mfg. No. / Description
3566160	(86160)	\$9.99	H0-9950000

Galvanized Bunk Brackets



- Heavy 11 gauge hot dipped galvanized steel bracket mounts 2" bunks on edge.
- Slotted for vertical adjustment to standard or deep-V hulls.
- Sold per pair.

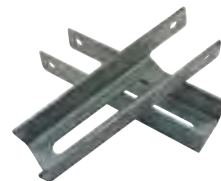

Order No.	Description	List Price	Mfg. No. / Description
7-1815	Length 9-1/2"	\$12.49	F0-4780000
7-1816	Length 12-5/8"	\$22.39	F0-7651000

Bunk Brackets



- Hot dip galvanized.
- Heavy 11 gauge steel brackets mount 2" bunks on edge.
- Slotted for vertical adjustment to standard or deep-V hulls.



SOLD EACH			
Order No.	Mfg. No. / Description	List Price	Mfg. No. / Description
577102	(86149)	\$6.49	F0-4540000

SOLD 2 PER PACK			
Order No.	Mfg. No. / Description	List Price	Mfg. No. / Description
5765102	(81225)	\$23.79	F0-5661000

Hex Head Bolts



- Zinc plated Grade 5 steel.
- Used for mounting brackets, couplers and winch stands.
- Package contains: (4) Bolts, (4) washers and (4) nyloc nuts.
- 1/2" x 3-1/2".



Order No.	Mfg. No. / Description	List Price	Mfg. No. / Description
580577	(86257)	\$12.69	F0-8880000

Flat Washers

- 5/8" x 1-1/2" OD.
- Thickness .078.
- Sold in packs of 50.



Order No.	Mfg. No. / Description	List Price	Mfg. No. / Description
730878	(1404)	\$10.39	G0-6960000

- Electronics
- Trolling Motors
- Instruments
- Electrical
- Lighting
- Anchor & Dock
- Safety
- Steering, Controls
- Pumps
- Fuel System
- Seating & Pedestals
- Trailering
- Tops & Covers
- Perform.
- Propellers
- Engine & Care
- Cleaning & Care
- Paint & Paint Acc.
- Fun & Flotation
- Topside Acc.
- Cockpit & Deck
- Hardware, Fasteners
- Camouflage
- Misc.
- Comm.

Galvanized U-Bolts



- Fully galvanized to protect against the elements.
- Includes: Galvanized nuts and washers.
- Sold per pair.

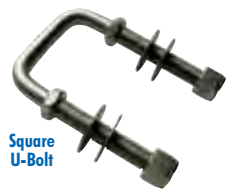

Square U-Bolt

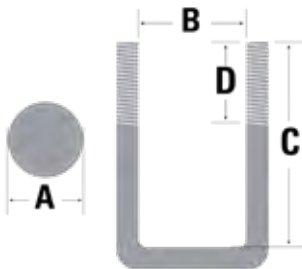

SQUARE U-BOLTS

Order No.	Thread Size (A)	Inside Width (B)	Length (C)	Thread Length (D)	List Price	
7-1776	3/8"	3-1/16"	2-3/8"	2"	\$9.49	FO-4660000
7-1772	3/8"	3-1/16"	4-1/2"	2"	\$9.19	FO-3460000
7-1764	1/2"	2-1/16"	4-3/16"	2"	\$10.49	FO-4370000
7-1792	1/2"	2-1/16"	4-13/16"	2"	\$10.19	FO-3170000
7-1768	1/2"	2-1/16"	5-3/16"	2"	\$10.19	FO-3170000
7-1788	1/2"	2-1/16"	5-1/2"	3"	\$10.49	FO-4370000
7-1802	1/2"	2-1/8"	4"	2"	\$10.29	FO-0270000
7-1759	1/2"	3-1/16"	4-5/16"	2"	\$10.49	FO-4370000
7-1774	1/2"	3-1/16"	5-3/16"	2"	\$10.49	FO-4370000
7-1789	1/2"	3-1/16"	6-3/16"	2"	\$10.49	FO-4370000
7-1804	1/2"	3-1/8"	3"	2"	\$10.29	FO-0270000
7-1806	1/2"	3-1/8"	4"	2"	\$10.29	FO-0270000
7-1808	1/2"	4-1/8"	3"	2"	\$10.89	FO-2670000

ROUND U-BOLTS

Order No.	Thread Size (A)	Inside Width (B)	Length (C)	Thread Length (D)	List Price	
7-1762	7/16"	2-1/2"	5-1/4"	2"	\$10.49	FO-4370000

U-Bolt Kits



- Used for mounting brackets to trailer frame.

ZINC PLATED. INCLUDES FLAT WASHERS AND NYLOC NUTS.

Order No.	Mfg. No.	A	B	C	D	Shape	Sold	List Price	
5765156	(86212)	7/16"-14	1-9/16"	3-9/16"	2"	Square	Each	\$6.69	FO-8640000
5765172	(86228)	7/16"-14	2-1/16"	2-5/16"	1"	Square	Each	\$6.49	FO-4540000
5765173	(86229)	7/16"-14	2-1/16"	4-5/16"	2"	Square	Each	\$7.59	FO-1350000
5765174	(86230)	7/16"-14	3-1/16"	3-5/16"	1-3/4"	Square	Each	\$8.09	FO-6650000
5765175	(86231)	7/16"-14	3-1/16"	4-5/16"	2"	Square	Each	\$8.39	FO-7850000
5765176	(86234)	7/16"-14	4-1/16"	2-13/16"	1-3/4"	Square	Each	\$7.79	FO-5450000
5765160	(86216)	3/8"-16	1-3/4"	4-13/16"	1-3/4"	Round	Each	\$5.79	FO-5040000
5765163	(86219)	3/8"-16	1-5/8"	3-9/16"	1-3/4"	Square	Each	\$6.39	FO-7440000
5765152	(86208)	3/8"-16	2-1/8"	4"	1-3/4"	Square	Pair	\$12.99	FO-9090000
5765153	(86209)	3/8"-16	3-1/8"	3"	1-3/4"	Square	Pair	\$11.69	FO-8180000
5765154	(86210)	3/8"-16	3-1/8"	4"	1-3/4"	Square	Pair	\$12.09	FO-6480000
5765155	(86211)	3/8"-16	4-1/8"	3"	1-3/4"	Square	Pair	\$12.29	FO-0680000
5765159	(86215)	1/2"-13	2-1/16"	4-13/16"	2"	Square	Each	\$8.39	FO-7850000
5765148	(86204)	1/2"-13	2-1/8"	4"	2"	Square	Pair	\$11.79	FO-5280000
5765158	(86214)	1/2"-13	3-1/16"	3-13/16"	1-1/2"	Square	Each	\$7.79	FO-5450000
5765149	(86205)	1/2"-13	3-1/8"	3"	1-1/2"	Square	Pair	\$12.09	FO-6480000
5765150	(86206)	1/2"-13	3-1/8"	4"	2"	Square	Pair	\$12.49	FO-4780000
5765151	(86207)	1/2"-13	4-1/8"	3"	2"	Square	Pair	\$12.79	FO-5980000

HOT DIP GALVANIZED COATING. INCLUDES FLAT WASHERS, LOCK WASHERS AND NUTS.

Order No.	Mfg. No.	A	B	C	D	Shape	Sold	List Price	
5765168	(86224)	3/8"-16	1-3/4"	4-13/16"	1-3/4"	Round	Each	\$6.89	FO-2840000
5765167	(86223)	1/2"-13	2-1/16"	4-13/16"	2"	Square	Each	\$9.59	FO-1760000
5765166	(86222)	1/2"-13	3-1/16"	3-13/16"	1-1/2"	Square	Each	\$8.99	FO-9260000

How to measure for U-Bolts:

- A = Rod Width - Threads Per Inch
- B = Between Leg Length (Inside Thread)
- C = Leg Length
- D = Thread Length



- Electronics
- Trolling Motors
- Instruments
- Electrical
- Lighting
- Anchor & Dock
- Safety
- Steering, Controls
- Pumps
- Fuel System
- Seating & Pedestals
- Trailering
- Tops & Covers
- Perform.
- Propellers
- Engine & Care
- Cleaning & Care
- Paint & Paint Acc.
- Fun & Flotation
- Topside Acc.
- Cockpit & Deck
- Hardware, Fasteners
- Camouflage
- Misc.
- Comm.

Guide Post Kit



- Includes: Guide poles and galvanized mounting hardware.
- Hardware kit includes: (2) PVC Caps, (2) "L" Tubes - 17" L x 19-3/4" H x 1-1/2" D, (2) "L" Tube Brackets - 1-1/2", (2) Hex Bolts - 5/16" x 3", (2) Hex Nuts - 5/16", (4) U-bolts - 3/8" x 5-3/4", (8) Lock Nuts - 3/8", and (8) Flat Washers - 3/8".
- Height 48".

Order No.	Description	List Price	
7-1623	Guide Post Kit	\$102.09	Z0-9020100

Round Aluminum Guide Ons



- 2 each of 1-1/4" schedule 40 aluminum tube and covered with 1-1/2" schedule 160 PVC pipe.
- Overall height 60" with top end caps that are not glued on. This allows customer to remove end cap and shorten guides if desired.
- 7-1627 Mounting Kit is sold separately.
- Light Mounting Kit (7-1628) is available.
- Sold per pair.

LIMITED QUANTITIES

Order No.	Description	List Price	
7-1625	Guide Ons	\$148.19	G0-9299000

Square Aluminum Guide Ons



- 2 each of 1-1/2" square tub with 1/8" wall thickness and covered with 2" schedule 160 PVC pipe.
- Overall height is 60" with top end caps that are not glued on. This allows customer to remove end cap and shorten guides if desired.
- 7-1627 Mounting Kit is sold separately.
- Light Mounting Kit (7-1628) is also available.
- Sold per pair.

Order No.	Description	List Price	
7-1626	Guide Ons	\$145.79	G0-8679000

PVC Post "Heavy Duty" Guide On's



- Feature bright orange end caps providing visual markers to help launch and load your boat safely.
- Post length 48".
- The 13° slant guide posts give a wider target when loading your boat.
- Braced inside with metal tubing 15" into the pipe.
- Bolts and nuts are zinc plated and mounting brackets are galvanized for lasting protection against corrosion.
- All mounting hardware included.
- Sold in pairs.

Order No.	Mfg. No. / Description	List Price	
578192	(86103)	\$115.19	F0-3608000

Adjustable PVC Guide On's



- Adapts to most tube and channel trailer frames.
- Galvanized for lasting protection and include heavy duty steel component parts.
- Bright orange end caps on these PVC guides provide a visible target when loading your boat.
- Boat guide on's are 48" high with up to 16" of side adjustment.
- All mounting hardware included.
- Sold in pairs.

Order No.	Mfg. No. / Description	List Price	
578290	(86105)	\$115.19	F0-3608000

Floating Guide Post



- Features the ability to adjust the overall height from 48" to 60".
- The user can choose to notch the post at a specific height or set on floatable mode and allow the waterline to naturally and automatically adjust the overall height as it enters/exists the water.
- It features a 30° slant through the bottom 18" to allow for varying hull shapes.
- The PVC pipe is non-marring, black in color and designed to hide the floating slot and holes for a clean look.
- Sold in pairs.

Order No.	Mfg. No. / Description	List Price	
578190	(86568)	\$241.39	H0-3844100

Fixed Angle Roller Guide On's



- Mount these 13" rubber rollers on top or beneath the frame for precise placement.
- The galvanized guide mount adjusts for widths up to 13" on each side and fit frames 2" to 4".
- All mounting hardware included.
- Sold in pairs.

Order No.	Mfg. No. / Description	List Price	
5765131	(86102)	\$169.19	F0-3481100

Adjustable Roller Side Guide On's



- Roller angle provides up to 16" of adjustment (8" each side) to fit the specific angle of your hull.
- Hot dip galvanized steel components with one piece adjustable clamp with U-bolt.
- Fits all channel and tube frames up to 5".
- Sold in pairs.

Order No.	Mfg. No. / Description	List Price	
578154	(86106)	\$174.29	F0-0022100

Boat Guide Kit



- Non marking marine grade PVC.
- Visually guides boat onto trailer.
- Tall 44" height.
- Adjustable up to 16" to fit any hull.
- Clamps on installation.
- For trailer frames up to 3" x 5".
- Sold in pairs.

Order No.	Mfg. No. / Description	List Price	
1840044	(GB44 0101)	\$165.09	G1-1370100

- Electronics
- Trolling Motors
- Instruments
- Electrical
- Lighting
- Anchor & Dock
- Safety
- Steering, Controls
- Pumps
- Fuel System
- Seating & Pedestals
- Trailer**
- Tops & Covers
- Perform.
- Propellers
- Engine & Care
- Cleaning & Care
- Paint & Paint Acc.
- Fun & Flotation
- Topside Acc.
- Cockpit & Deck
- Hardware, Fasteners
- Camouflage
- Misc.
- Comm.



SPECIAL HANDLING MAY APPLY



Low Rider Guide On's



- Ideal for Jon boats, bass boats and personal watercraft.
- The guide posts are made of 1-1/2" square, 16-gauge steel tubing and galvanized for long lasting protection.
- Guide covers are made from high impact non-marking molded PVC.
- Mounts to trailer cross members 2" wide and 2" - 4" high.
- All mounting hardware included.
- Sold in pairs.

Order No.	Mfg. No. / Description	List Price	
578310	(86466)	\$113.89	F0-2797000

Bunk Board Guide On's



- The 2x4 black carpeted bunk boards are offered in 24" or 60" lengths.
- Posts can be mounted 5" - 11" on the side of the frame.
- If mounted above the frame, bunk placement is 19" high.
- U-bolt & nuts are zinc plated and mounting hardware is galvanized for corrosion protection.
- Kit fits frames 2" and 3" wide up to 4" high.
- All mounting hardware included.
- Sold in pairs.

Order No.	Mfg. No. / Description	List Price	
578200	(86123) Length 24"	\$168.09	F0-6671100
578206	(86124) Length 60"	\$246.79	F0-5727100

Bunk Board Guide On Post Hardware Kit



- Designed to mount longer bunk board guides, such as tandem and triple-axle trailers.
- Kit includes 4 mounting posts and hardware only.
- Carpeted bunks not included.

Order No.	Mfg. No. / Description	List Price	
3560101	(86340)	\$180.09	G1-6071100

Pontoon Guide On's



- Bright orange end caps on these PVC guide guides give you a bright, visible target when loading your pontoon boat.
- Designed to be mounted between the pontoons.
- Made of 1-1/2" square, 16-gauge steel tubing and covered with 2" x 20" non-marking white PVC pipe.
- Mounts to trailer cross members 2" wide and 2" - 4" high.
- All mounting hardware included.
- Sold in pairs.

Order No.	Mfg. No. / Description	List Price	
578300	(86465)	\$113.19	F0-3297000

Pontoon "Floating" Guide On's



- Designed for submerged trailers, the PVC guide automatically rises upward adding an additional 12" in visibility, for a total adjustable viewing height of 24" - 36".
- Made of 1-1/2" square, 16-gauge steel tubing galvanized and covered by 2" x 20" PVC pipe.
- Mounts to trailer cross members 2" wide by 2", 3" or 4" high.
- All mounting hardware included.
- Sold in pairs.

Order No.	Mfg. No. / Description	List Price	
578325	(86468)	\$145.59	F0-1910100

High Impact Pontoon Guide On's



- Guide your pontoon boat safely onto the trailer in high winds and strong currents with these high impact guide on's.
- The hot dip galvanized steel 2-1/2" square tube posts are covered with non-marking molded PVC material and designed to be mounted between the pontoons.
- Mounts to trailer cross members 2" wide by 2" - 3" high.
- All mounting hardware included.
- Sold in pairs.

Order No.	Mfg. No. / Description	List Price	
578320	(86467)	\$156.89	F0-2890100

I-beam Mounting Kit - Guide Posts



- The I-beam mounting kit allows you 1-1/2" square guide tube to securely mount onto any steel or aluminum I-beam trailer frame.
- The kit includes: (4) Brackets, (2) smaller 3/8" bolts and (2) 3/8" bolts depending of frame rail width.
- Brackets are galvanized, hardware in zinc plated.

Order No.	Mfg. No. / Description	List Price	
578374	(86569)	\$29.99	F0-9902000

Guide On Mounting Kit



- Designed to mount either round or square guides under trailer frame.
- Includes: (4) stainless steel U-bolts 8" long, (8) stainless steel 3/8" lock nuts, (2) aluminum plates with holes spaced for various width trailer frames, (4) 1" x 2" x aluminum channel to fit round guides and (1) instruction sheet.

Order No.	Description	List Price	
7-1627	Mounting Kit	\$104.29	G0-7896000

Trailer Light Mounting Kit



Order No.	Description	List Price	
7-1628	Mounting Kit	\$21.99	G0-3741000

SPECIAL HANDLING MAY APPLY



- Electronics
- Trolling Motors
- Instruments
- Electrical
- Lighting
- Anchor & Dock
- Safety
- Steering, Controls
- Pumps
- Fuel System
- Seating & Pedestals
- Trailering
- Tops & Covers
- Perform.
- Propellers
- Engine & Care
- Cleaning & Care
- Paint & Paint Acc.
- Fun & Flotation
- Topside Acc.
- Cockpit & Deck
- Hardware, Fasteners
- Camouflage
- Misc.
- Comm.

5' Hull Sav'r Roller Bunk

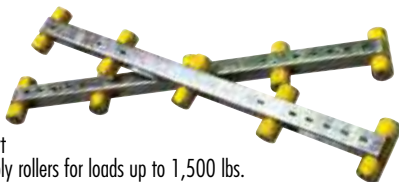

- Two heavy duty 5' galvanized steel frames provide full hull support using 5 sets of amber Hull Sav'r poly rollers for loads up to 1,500 lbs.
- Hull Sav'r rollers will not mark hull bottoms and have a limited lifetime warranty against cutting and fading.
- Length 5'.

Order No.	Mfg. No. / Description	List Price	
578208	(86145)	\$290.89	F0-2630200

Modular Glide On's

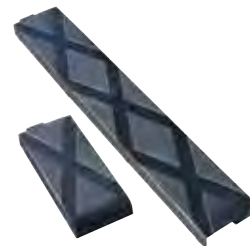

- Self-centering bunk glide on's feature interlocking modular sections make loading and unloading your boat effortless.
- Designed to accommodate 2x6 bunk boards in a variety of lengths up to 16' (or two 8' boards).
- Includes: (4) 3' sections, (4) 1' end sections and mounting hardware.
- Black.

Order No.	Mfg. No. / Description	List Price	
570654	(86295)	\$92.99	F0-9056000

Marine Bunk Slides



- Makes launching your boat or watercraft easy, slides effortlessly off bunks and into the water.
- Unique profile provides extra cushioning between the boat and trailer bunks.
- Washout channels flush sand and debris off of the slides and away from the hull.
- Allows you to unload and load your boat or watercraft in shallower water.
- Installation for both horizontal and vertical bunks.

Order No.	Mfg. No.	Size	Color	Sold in Packs of	List Price	
1331927	(23010)	3" x 15"	Black	10	\$39.99	F0-9972000
1331928	(23011)	3" x 15"	White	10	\$40.09	F0-6082000
1331930	(23030)	1-1/2" x 15"	Black	10	\$30.09	F0-6012000

Bunk Slicks

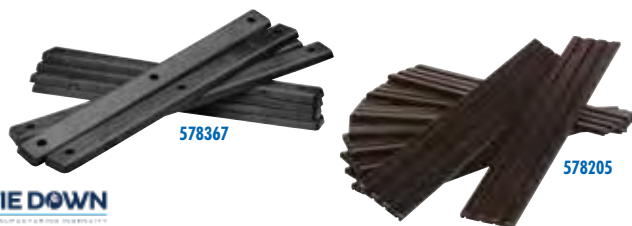

- PVC molded Bunk Slicks bolts directly onto carpeted bunk boards.
- Works with any standard bunk board.
- Allows the boat to smoothly slide on and off the trailer.

Order No.	Mfg. No. / Description	List Price	
578205	(86164) 3" x 16"	\$63.19	F0-3244000
578367	(86170) 1-3/4" x 17"	\$38.39	F0-7862000

Bunk Wrap Kits with End Caps



- Replace your old, dry rotted carpeted bunks and save your gel coat.
- Less strain on arms, ropes and pulleys.
- Carpet allows fine particles of sand to embed into the carpet that slowly grinds away at your gel coat.
- Wash out channels flush sand, salt and other debris away from the hull.
- Guaranteed not to crack, chip or wear out and is impervious to sun and salt.
- With Bunk Wraps there is no need to remove your old worn out carpet.
- Just mount the Bunk Wraps right over the top!
- Make sure you put a layer of wax on your hull during installation.
- Includes: (4) Endcaps and stainless steel hardware.

COOL GREY

Order No.	Mfg. No. / Description	List Price	
1331923	(23050) Dimensions: 16' x 2" x 4"	\$60.09	F0-6024000
1331925	(23052) Dimensions: 16' x 2" x 6"	\$74.99	F0-9425000

MIDNIGHT BLACK

Order No.	Mfg. No. / Description	List Price	
1331924	(23050-BK) Dimensions: 16' x 2" x 4"	\$60.09	F0-6024000
1331926	(23052-BK) Dimensions: 16' x 2" x 6"	\$74.99	F0-9425000
1331920	(23054-BK) Dimensions: 24' x 2" x 4"	\$74.99	F0-9425000

Slydz-On Spray On Bunk Lubricant



- Easily load and unload after application.
- Less strain on bow-eyes, pulleys, cranks, and users.
- Reduces chances for power-loading.
- Fast and simple application for both horizontal and vertical bunks.
- Also works on workstations, boat lifts and watercraft dollies.

Order No.	Mfg. No. / Description	List Price	
1331933	(23200) 16 fl. oz.	\$18.99	F0-9231000

Trailer Bunk Padding



- Marine grade carpet with strong acrylic backing.
- Weather resistant.
- Easy to cut and custom fit.
- Length 12'.

Order No.	Description	List Price	
7-59110	Width 8"	\$19.89	G0-3331000
7-59111	Width 12"	\$25.59	G0-5171000

Bunk Carpet



- Replace worn, frayed bunks with this all-weather marine grade carpet that will resist rot or mildew.
- Will wrap completely around 2x4 boards and around three sides of 2x6 bunk boards.
- Black.

Order No.	Mfg. No. / Description	List Price	
578366	(86137) Dimensions: 11" W x 12' L	\$26.49	F0-4581000



SPECIAL HANDLING MAY APPLY



- Electronics
- Trolling Motors
- Instruments
- Electrical
- Lighting
- Anchor & Dock
- Safety
- Steering, Controls
- Pumps
- Fuel System
- Seating & Pedestals
- Trailering**
- Tops & Covers
- Perform.
- Propellers
- Engine & Care
- Cleaning & Care
- Paint & Paint Acc.
- Fun & Flotation
- Topside Acc.
- Cockpit & Deck
- Hardware, Fasteners
- Camouflage
- Misc.
- Comm.

Superlube Hub Kits



- Superlube Trailer Hub Kit with everything you need to replace a stud hub on a straight spindle.
- Grease fitting on the rear of the hub to ease changing grease without removing the hub.
- Hub is E-coat coated for corrosion resistance and is factory pre-greased, filled with Lucas Red n Tacky Grease.
- Triple lip seal to keep water out. Kit contains bearings, seal, dust cap, cotter key and lug nuts.

4 STUD HUB

Order No.	Mfg. No.	Capacity	Bearings	List Price	
657683	(K08-523-C4)	1,250#	2 Each of 1"	\$95.99	F0-9176000

5 STUD HUB

Order No.	Mfg. No.	Capacity	Bearings	List Price	
657722	(K-08-448-CE)	1,250#	2 Each of 1"	\$103.69	F0-8527000
657734	(K-08-448-CA)	1,350#	2 Each of 1-1/16"	\$101.99	F0-9317000
657746	(K08-436-C2)	1,750#	1 Each of 1-1/16" & 1-3/8"	\$116.29	F0-0418000

GalvX Coated Wheel Hub Kits



- Trailer Hub Kit with everything you need to replace a 5 stud hub on a straight spindle.
- Hub is GalvX coated for corrosion resistance and is factory pre-greased, filled with Lucas Red n Tacky Grease.
- Triple lip seal to keep water out.
- Kit contains bearings, seal, dust cap, cotter key and lug nuts.

5 STUD HUB

Order No.	Mfg. No.	Capacity	Bearings	List Price	
657646	(K08-448-C0)	1,250#	2 Each of 1"	\$91.99	F0-9346000
657657	(K08-448-CC)	1,350#	2 Each of 1-1/16"	\$91.19	F0-3836000
657669	(K08-436-CA)	1,750#	1 Each of 1-1/16" & 1-3/8"	\$115.09	F0-6508000

Vortex Hub Kit



- Vortex Trailer Hub Kit with everything you need to replace a 5 stud hub on a tapered spindle that uses 1-3/8" and 1-1/16" bearings.
- Grease fitting on the rear of the hub to ease changing grease without removing the hub.
- Hub is E-coat coated for corrosion resistance and is factory pre-greased, filled with Lucas Marine Grease and has a reusable screw on cap.
- Triple lip seal to keep water out.
- Kit contains bearings, seal, dust cap, cotter key and lug nuts.

5 STUD HUB

Order No.	Mfg. No. / Description	Bearings	List Price	
657642	(K08-447-C2)	1 Each 1-1/16" & 1-3/8"	\$152.59	F0-1860100
570630	(81143) Vortex Repl. Cap Assembly - 2 Per Pack		\$39.29	F0-0572000

Wheel Bearing Kits



- Precision tapered roller bearings.
- Kit includes: 2ea cones, 2ea cups, 1ea seal and 1 ea cotter pin.
- Dust cap sold separately.

Order No.	Spindle	Outer Hub	Race OD	List Price	
7-0952	3/4"	1.781		\$17.49	F0-4221000
7-0953	1"	1.980		\$17.09	F0-6911000
7-0954	1-1/16"	1.980		\$16.29	F0-0411000
7-0956	1-1/4"	2.328		\$22.09	F0-6451000
7-0959	1-1/16" x 3/4"	1.781		\$17.89	F0-2521000
7-0957	1-1/4" x 3/4"	1.781		\$19.19	F0-3431000
7-0958	1-3/8" x 1-1/16"	1.980	2.361	\$16.69	F0-8611000
7-0955	1-3/8" x 1-1/16" w/Special Cup	1.980	2.328	\$18.59	F0-1031000

Trailer Wheel Bearing Kits



- Kits include: (2) Bearings, (2) races, seal and cotter pin.

BEARING KIT FOR 3/4" SPINDLE

- Spindle OD: 3/4", Outer Hub ID:1.781", Bearing Cone: LM11949, Bearing Cup: LM11910, Seal: 203020.

Order No.	Mfg. No. / Description	List Price	
5765069	(81105)	\$28.39	F0-7891000

BEARING KIT FOR 1-1/4" x 3/4" SPINDLE

- Spindle OD: 1-1/4" x 3/4", Outer Hub ID:1.781", Bearing Cone: LM67048, LM11949, Bearing Cup: LM67010, LM11910.

Order No.	Mfg. No. / Description	List Price	
5765076	(81130)	\$28.89	F0-2202000
1671131	(81131) With Dust Cap	\$38.99	H0-9332000

BEARING KIT FOR 1-3/8" x 1-1/16" SPINDLE

- Spindle OD: 1-3/8" x 1-1/16", Outer Hub ID:1.980", Bearing Cone: L44649, L68149, Bearing Cup: L44610, L68111.

Order No.	Mfg. No. / Description	List Price	
1671142	(81142) With Dust Cap	\$38.09	L0-5091000

BEARING KIT FOR 1" SPINDLE

- Spindle OD: 1", Outer Hub ID:1.980", Bearing Cone: L44643, Bearing Cup: L44610, Seal: 203029

Order No.	Mfg. No. / Description	List Price	
1671110	(81110)	\$37.09	L0-5581000

BEARING KIT FOR 1-3/8" SPINDLE

- Kits include: (2) Bearings, (2) races, seal and cotter pin.

Order No.	Mfg. No. / Description	List Price	
5765077	(81135)	\$27.59	F0-1391000

BEARING KIT FOR 1-3/4" x 1-1/4" SPINDLE

- Spindle OD: 1-3/4" x 1-1/4", Bearing Cone: 25580, 15123, Bearing Cup: 25520, 15245. Includes standard seal 225255UC and UFP seal 212338UC.

Order No.	Mfg. No. / Description	List Price	
1671128	(81128) With Dust Cap	\$62.99	G1-4904000

- Electronics
- Trolling Motors
- Instruments
- Electrical
- Lighting
- Anchor & Dock
- Safety
- Steering, Controls
- Pumps
- Fuel System
- Seating & Pedestals
- Trailer
- Tops & Covers
- Perform.
- Propellers
- Engine & Care
- Cleaning & Care
- Paint & Paint Acc.
- Fun & Flotation
- Topside Acc.
- Cockpit & Deck
- Hardware, Fasteners
- Camouflage
- Misc.
- Comm.

Replacement Bearings



- Bearing cone.
- Sold per pair.

Order No.	Mfg. No. / Description	List Price	
5765107	(81302) 1" Bearing	\$17.99	F0-9521000
5765108	(81304) 1-1/16" Bearing	\$18.29	F0-0821000
5765110	(81306) 1-1/4" Bearing	\$19.99	F0-9931000
5765112	(81308) 1-3/8" Bearing	\$17.99	F0-9521000

Replacement Seals



- Sold per pair.

Order No.	Description	List Price	
7-1861	1" Lip Seal for 3/4" Bearings	\$9.99	F0-9960000
7-1860	1-1/4" Lip Seal for 1" and 1-1/16" Bearings	\$6.29	F0-0440000
7-1862	1-1/2" Lip Seal for 1-1/4" Bearings	\$9.99	F0-9960000
7-1863	1-3/4" Lip Seal for 1-3/8" Bearings	\$6.29	F0-0440000

LIMITED QUANTITIES

Replacement Seals



- Triple lip.
- Rubber coated for corrosion resistance.
- Sold per pair.

Order No.	Mfg. No. / Description	List Price	
5765114	(81310) 1-1/4" Seal for 1" & 1-1/16" Bearings	\$6.49	F0-4540000
5765115	(81312) 1-1/2" Seal for 1-1/4" Bearings	\$10.69	F0-8470000
5765116	(81313) 1-3/4" Seal for 1-3/8" Bearings	\$7.19	F0-3050000
1672424	(81323) 1.68" Seal for 1-3/8" Bearings (Triple Lip)	\$11.99	G1-9770000

Replacement Grease Seals



- Typical application: Ranger.
- Shaft diameter: 1.68".
- Seal type: Double lip.
- Sold each.

Order No.	Mfg. No. / Description	List Price	
5765011	(11087) Bore Diameter: 2.33" Case width: .310"	\$4.59	F0-1230000
5765012	(11097) Bore Diameter: 2.55" Case width: .500"	\$4.79	F0-5330000

Replacement Bearing Cup/Race



- Sold per pair.

Order No.	Mfg. No.	Bearing Size	List Price	
5765106	(81301)	3/4"	\$9.99	F0-9960000
5765109	(81305)	1-1/16"	\$10.29	F0-0270000
5765113	(81309)	1-3/8"	\$9.79	F0-5860000

Turbo Lube Replacement Cap



- OEM replacement cap for Turbo Lube oil bath hubs with capacities of 1,750# and less.
- Cap is threaded and fitted with an O-ring and rubber plug to seal the front end of Turbo Lube hubs.
- Sold each.

Order No.	Mfg. No. / Description	List Price	
5765026	(48399GA)	\$17.09	F0-6911000

Bearing Dust Caps



- Protect against damage from water and dirt intrusion of wheel bearings.
- Automatically maintains the correct internal pressure.
- Diameter 1.98".
- Includes rubber grommet.
- Sold per pair.

Order No.	Description	List Price	
7-59061	Bearing Dust Caps	\$11.09	F0-6770000

SuperLube Dust Caps



- Zinc plated.
- Dust caps with center rubber plugs for EZ Lube and SuperLube caps.
- Diameter 1.98".
- Sold per pair.

Order No.	Mfg. No. / Description	List Price	
578369	(81168) Dust Caps	\$15.19	F0-3601000
578370	(81174) Rubber Plugs	\$5.59	F0-1930000

Non-Lube Dust Caps



- Zinc plated.
- Standard metal replacement dust caps fit most hubs and integral hub brake assemblies.
- Diameter 1.98".
- Sold per pair.

Order No.	Mfg. No. / Description	List Price	
661333	(81167)	\$6.09	F0-6240000

Dust Cap Grommets



- Rubber grommet for use with bearing dust caps.
- Universal.
- Fits all standard dust caps.
- Sold per pair.

Order No.	Description	List Price	
7-59062	Rubber Grommet	\$5.89	F0-2140000

Spring-Loaded Bearing Protectors



- Steel spring keeps hub grease under pressure, guarding against water seepage and failure.
- Grease fitting in cap.
- Sold per pair.

Order No.	Description	List Price	
7-59038	1.980"	\$33.89	H0-3302000

Bearing Protector Caps



- Helps to protect bearings from water and dirt intrusion of bearings.
- Fits 1.980".
- Sold per pair.

Order No.	Description	List Price	
7-59030	Bearing Protector Caps	\$4.99	G0-4330000

- Electronics
- Trolling Motors
- Instruments
- Electrical
- Lighting
- Anchor & Dock
- Safety
- Steering, Controls
- Pumps
- Fuel System
- Seating & Pedestals
- Trailer
- Tops & Covers
- Perform.
- Propellers
- Engine & Care
- Cleaning & Care
- Paint & Paint Acc.
- Fun & Flotation
- Topside Acc.
- Cockpit & Deck
- Hardware, Fasteners
- Camouflage
- Misc.
- Comm.

Bearing Buddy® - Stainless Steel



- Prevents wheel bearing failure by keeping water and dirt out of hubs.

Order No.	Mfg. No. / Description	List Price
231605	(41204) 1781SS For Use with 1.781" Hub Bore	\$30.69 FO-8412000
231617	(42304) 1938SS For Use with 1.938" Hub Bore	\$35.59 FO-1942000
231629	(42604) 1968SS For Use with 1.968" Hub Bore	\$35.59 FO-1942000
231631	(42104) 1980SS For Use with 1.980" Hub Bore	\$35.49 FO-4842000
2842404	(42404) 2047SS For Use with 2.047" Hub Bore	\$35.99 E0-9962000
2842804	(42804) 2080SS For Use with 2.080" Hub Bore	\$35.99 E0-9962000
231634	(43104) 2328SS For Use with 2.328" Hub Bore	\$39.09 FO-6372000

WITH VISUAL LUBRICANT LEVEL INDICATOR

- Has a blue ring which acts as a visual lubricant level indicator inside the hub.
- For use with 1.980" hub bore.

Order No.	Mfg. No. / Description	List Price
231643	(42204) 1980A-SS	\$35.99 FO-9152000
2842208	(42208) 1980A-SS With Bearing Buddy Bra	\$37.69 E0-7282000

Bearing Buddy® with Bra - Chrome Plated



- Trailer wheel bearing protectors.
- For use with 1.980" hub bore.
- Prevents wheel bearing failure by keeping water and dirt out of hubs.
- Includes the bearing buddy bra.

Order No.	Mfg. No. / Description	List Price
2842101	(42101)	\$27.39 E0-4502000

Bearing Buddy® - Chrome Plated



- Prevents wheel bearing failure by keeping water and dirt out of hubs.
- For use with 1.980" hub bore.

Order No.	Mfg. No. / Description	List Price
231630	(42102) 1980	\$25.99 FO-9181000

Bearing Buddy® Bras



- A vinyl cover that fits over the Bearing Buddy to contain excess grease and keep it off tires and wheels.
- The Bearing Buddy's automatic pressure relief feature will allow the excess grease to escape if the hub is overfilled.
- While trailering, this grease can be thrown onto wheels.
- Can be easily removed for checking hub lubricant level.

Order No.	Mfg. No. / Description	List Price
231528	(70017) Fits 1781, 1810	\$5.49 FO-4830000
231530	(70019) Fits 1938, 1968, 1980, 2047, 2080	\$5.49 FO-4830000
231531	(70023) Fits 2240, 2328, 2441, 2562, 2717	\$5.49 FO-4830000

Pro Performance Grease



- Specifically formulated for marine applications.
- Premium lithium formulation for optimum corrosion protection in freshwater and saltwater applications.
- Ideal for marine trailer wheel bearing, universal joints and outdrive pivot joints.
- Operating temperature: -40° F - 350° F.

Order No.	Mfg. No. / Description	List Price
451524	(18-9200-4) 3 oz. Cartridge	\$22.34 Z0-4651000
1892000	(18-9200-0) 8 oz. Tube	\$7.99 Z0-1550000



Wheel Bearing Grease



- Superior rust and corrosion protection from salt water, salt air and atmospheric chemicals.
- Special water-insoluble formula is highly resistant to wash-out.
- NLGI #2.
- Recommended for corrosive marine applications - trailer wheel bearings, water pumps, hinges, pins, winches and anchor chain reels.

Order No.	Mfg. No. / Description	List Price
451725	(26003) 2 Pack of 3 oz. Cartridge	\$13.49 FO-4490000
451726	(026014) 14 oz. Cartridge	\$12.89 FO-2090000
451738	(26016) 1 lb. Tub (16 oz.)	\$15.09 FO-6501000



Grease



- A high performance, multi-purpose, extreme pressure rated NLGI #2 grade premium grease.
- Engineered for maximum shear stability, film strength and heavy shock-load performance, CorrosionX Grease offers unsurpassed wear and extreme pressure protection.
- Over-based calcium sulfonate complex thickener maximizes pumpability, water resistance and high drop point.
- Superior anti-wear additives lubricate and prevent wear.

Order No.	Mfg. No. / Description	List Price
302965	(96801) 15 oz. Tube	\$16.99 FO-9811000



Lucas Marine Grease



- A premium, heavy duty lithium complex NLGI GC-LB Certified grease formulated with a unique additive system designed to provide maximum lubrication under the most severe marine operating conditions.
- A true marine grease with applications in trailer wheel bearing, trailer chassis lubrication, automotive wheel bearings and outboards.

Order No.	Mfg. No. / Description	List Price
570633	(11008) 14 oz. Tube (Case of 10)	\$15.09 FO-6501000



Lucas Red "N" Tacky Grease



- Smooth and tacky complex grease enhanced with rust and oxidation inhibitors.
- It exhibits strong resistance to spray off and water washout.
- This grease demonstrates excellent mechanical stability and has a prolonged storage life.
- It can endure heavy loads over extended periods.
- It also delivers extreme protection for plain bearings, sliding parts, and open gears.

Order No.	Mfg. No. / Description	List Price
1671009	(11008RCS) 14 oz. Tube (Case of 10)	\$14.99 G1-4790000



SPECIAL HANDLING MAY APPLY



- Electronics
- Trolling Motors
- Instruments
- Electrical
- Lighting
- Anchor & Dock
- Safety
- Steering, Controls
- Pumps
- Fuel System
- Seating & Pedestals
- Trailer
- Tops & Covers
- Perform.
- Propellers
- Engine & Care
- Cleaning & Care
- Paint & Paint Acc.
- Fun & Flotation
- Topside Acc.
- Cockpit & Deck
- Hardware, Fasteners
- Camouflage
- Misc.
- Comm.

Wheel Bearing and Chassis Grease



- A NLGI #2 grade of grease. Manufactures to be the finest custom made grease you can buy today, fortified with additives to protect against rust, corrosion, oxidation and wear.
- Aqua Lube is a non-melting, custom built grease that protects even against salt water.

LIMITED QUANTITIES

Order No.	Mfg. No. / Description	List Price	
299012	(AL3336) 3 Pack of 3 oz. Cart.	\$9.09	F0-6360000
299010	(AL 1450) 14.5 oz. Cartridge	\$7.89	F0-2550000

Sta-Plex™ Premium Red Grease



- Premium red grease with heavy duty lubricant that withstands high temperature and high pressure.
- Red color allows for easy visual inspection of film coverage.

LIMITED QUANTITIES

Order No.	Mfg. No. / Description	List Price	
289144	(SL3192) 11 oz.	\$12.29	G0-3280000

Sta-Lube® Marine Grease



- A blue tacky, calcium sulfonate grease using a highly refined base oil.
- It has been formulated with a polymer to provide adhesive, non-blend and water wash-out characteristics.
- Will resist water under the most severe water conditions.

Order No.	Mfg. No. / Description	List Price	
1493121	(SL3121) 14 oz.	\$16.69	F0-8611000

Lever Action Grease Gun



- Corrosion resistant bright metal finish.
- Lever action grease gun for use with all 14 and 14.5 oz. grease cartridges.
- Flexible nozzle 451600 (028800) available for hard to reach fittings.
- Heavy gauge steel barrel helps prevent dents, promoting longer life.

Order No.	Mfg. No. / Description	List Price	
451598	(28714)	\$34.49	F0-4142000

Standard Duty Pistol Grease Gun



- Corrosion resistant finish.
- Can be used one-handed.
- Accepts 14 oz. refill cartridges.
- Fits standard zerk fittings.

Order No.	Mfg. No. / Description	List Price	
451599	(028724)	\$32.29	F0-0622000

Standard Duty Lever Grease Gun



- Corrosion resistant finish.
- Lever action for maximum pressure per stroke.
- Ideal for all marine, auto and home lubrication tasks.
- Accepts 14 oz. refill cartridges.
- Fits standard zerk fittings.

Order No.	Mfg. No. / Description	List Price	
451501	(028704)	\$28.79	F0-5102000

Extension Hose for 14 oz. Grease Gun



- Adds 10-1/2" working length to 14 oz. lever action grease gun.
- Excellent for use on hard to reach fittings.
- Screw male end of extension hose into grease gun output fitting.
- Attach female end of extension hose to grease fitting.

Order No.	Mfg. No. / Description	List Price	
451600	(28800)	\$12.09	F0-6480000

Pistol Grease Gun with 3 oz. Cartridge



- Contains lube gun and 3 oz. cartridge of marine wheel bearing grease.
- Nozzle can be removed and flexible nozzle 451600 (028800) installed.
- Convenient, one hand application heavy duty design for years of trouble-free use.

Order No.	Mfg. No. / Description	List Price	
451500	(28703)	\$39.29	F0-0572000

Disc Brake Assembly "G5"



- Stainless steel disc brakes, integral stainless steel rotor mated to a GalvX coated hub assembled with seal, bearings and grease.
- Aluminum caliper uses a stainless steel/aluminum piston and ceramic pads with stainless steel backing plates.
- Kit has the mounting bracket and all mounting hardware.
- For one wheel.
- Two kits required per axle.

Order No.	Mfg. No. / Description	List Price	
657322	(82091) 10" 5 Lugs Fits Most 14" Wheels	\$410.09	F0-6078200
657325	(82092) 12" 6 Lugs Fits Most 15" Wheels	\$553.89	F0-2778300

Disc Brake Kit "G5"



- Eliminator SS rotor 10" integral style disc brakes with actuator. Stainless steel rotor mated with a GalvX coated hub.
- Disc brake actuator features the Drop n Go coupler, oversize master cylinder and back up solenoid installed.
- Kit includes a 6,600 lb capacity disc brake actuator, two 5 lug integral hub/rotors preassembled with seal, bearings and grease, and a brake line kit with attachment hardware.
- Fits most 14" and larger wheels.

Order No.	Mfg. No. / Description	List Price	
570636	(82404)	\$1,353.99	F0-9774900

- Electronics
- Trolling Motors
- Instruments
- Electrical
- Lighting
- Anchor & Dock
- Safety
- Steering, Controls
- Pumps
- Fuel System
- Seating & Pedestals
- Trailerling**
- Tops & Covers
- Perform.
- Propellers
- Engine & Care
- Cleaning & Care
- Paint & Paint Acc.
- Fun & Flotation
- Topside Acc.
- Cockpit & Deck
- Hardware, Fasteners
- Camouflage
- Misc.
- Comm.

Vented Rotor Integral Hub Disc Brake Kits



- Integral vented GalvX coated one piece hub rotor assembled with seal, bearings and grease.
- Aluminum calipers have stainless steel/aluminum pistons and use ceramic pads with stainless steel backing plates.
- Caliper mounting bracket and stainless steel slider pins included.
- Brake for one wheel.
- Two kits required per axle.



10" VENTED ROTOR INTEGRAL HUB DISC BRAKE KIT

- 9.6" one piece 5 lug hub rotor. Fits most 13" and larger wheels.

Order No.	Mfg. No. / Description	List Price	
657104	(82113)	\$312.79	F0-5981200

12" VENTED ROTOR INTEGRAL HUB DISC BRAKE KIT

- 12" one piece 6 lug hub rotor. Fits most 15" and larger wheels.

Order No.	Mfg. No. / Description	List Price	
570651	(82100)	\$360.89	F0-2625200

12" Vented Disc Brake Kit



- Eliminator integral rotor style disc brakes with actuator.
- Disc brake actuator features the Drop n Go coupler, oversize master cylinder and back up solenoid installed.
- Kit includes a disc brake actuator, two integral rotors preassembled with seal, bearings and grease, and a brake line kit with attachment hardware.
- 12" one piece 6 lug hub rotor.
- Fits most 15" and larger wheels.

Order No.	Mfg. No. / Description	List Price	
570642	(82406)	\$1,372.39	F0-7606900

Brake Actuators



- Brake actuator loaded with features.
- Drop n Go coupler with auto latch, coiled cable safety cable, cast steel ball clamp, grease fittings on the roller pins, aluminum master cylinder, uses 2 inch ball (not included)

MODEL 660 BRAKE ACTUATORS - 6,600 LB. CAPACITY

Order No.	Mfg. No. / Description	List Price	
657300	(82400) Disc Brake Actuator with Back Up Solenoid	\$418.49	F0-4929200
657301	(82401) Drum Brake Actuator	\$374.19	F0-3916200

MODEL 800 BRAKE ACTUATORS - 8,500 LB. CAPACITY

Order No.	Mfg. No. / Description	List Price	
570645	(82403) Drum Brake Actuator	\$547.39	F0-7138300
570648	(82402) Disc Brake Actuator with Back Up Solenoid	\$594.69	F0-8261400

Hydraulic Brake Hose Kits



SINGLE AXLE HYDRAULIC BRAKE HOSE KIT

- Single axle brake hose kit. Contains 240", 24", 76" brake hoses and hardware to install.

Order No.	Mfg. No. / Description	List Price	
657106	(80326)	\$145.39	F0-7710100

TANDEM AXLE HYDRAULIC BRAKE HOSE KIT

- Tandem axle brake line kit includes 240", 38", 24", 76" brake hoses, two T-blocks and installation hardware. All you need to hook up to a brake actuator and two axles of brakes, drum or disc.

Order No.	Mfg. No. / Description	List Price	
657108	(80328)	\$230.69	F0-8416100

Hydraulic Brake Hose Kit for Additional Axle



- Add on kit must be used with the single axle kit.
- Allows the addition of brakes to a second axle.
- Includes: (1) 76" brake line with male end connectors, (1) 38" brake line with male end connectors, (2) 24" brake lines with male end connectors, (2) three hole female T's, (1) T plug, (2) T clamps, (2) cable clamps, (6) #10 self tapping screws and (4) 15" cable ties.

Order No.	Mfg. No. / Description	List Price	
5765038	(80327)	\$104.89	F0-2437000

24" Flexible Hydraulic Brake Line Kit



- Brake line kit with two 24" male/male black rubber brake hoses.
- Two 3/16" inverted flare unions for connecting to other hoses included.

Order No.	Mfg. No. / Description	List Price	
657227	(81099)	\$72.19	F0-3505000

Reverse Lock Out Solenoid



- Lock out solenoid for use on disc brake actuators.
- This is a stop flow unit used on older model actuators.
- Requires an electrical hook up to the reverse lights.

Order No.	Mfg. No. / Description	List Price	
657203	(81103)	\$82.19	F0-3575000

- Electronics
- Trolling Motors
- Instruments
- Electrical
- Lighting
- Anchor & Dock
- Safety
- Steering, Controls
- Pumps
- Fuel System
- Seating & Pedestals
- Trailer
- Tops & Covers
- Perform.
- Propellers
- Engine & Care
- Cleaning & Care
- Paint & Paint Acc.
- Fun & Flotation
- Topside Acc.
- Cockpit & Deck
- Hardware, Fasteners
- Camouflage
- Misc.
- Comm.

- Electronics
- Trolling Motors
- Instruments
- Electrical
- Lighting
- Anchor & Dock
- Safety
- Steering, Controls
- Pumps
- Fuel System
- Seating & Pedestals
- Trailer
- Tops & Covers
- Perform.
- Propellers
- Engine & Care
- Cleaning & Care
- Paint & Paint Acc.
- Fun & Flotation
- Topside Acc.
- Cockpit & Deck
- Hardware, Fasteners
- Camouflage
- Misc.
- Comm.

10" Hydraulic Drum Brake Assembly



- Hydraulic 10" drum brake backing plates for 5 lug wheels.
- Aluminum wheel cylinder.
- Stainless steel springs.
- Brake pads are bonded and riveted.
- Assembled backing plates only, does not include drum hubs.

Order No.	Mfg. No. / Description	List Price
657320	(K08-G01-01) GalvX	\$347.19
1670128	(82095) E-Coat	\$283.09

10" Brake Drum Hub



- 10" drum hub designed to work with electric or hydraulic drum brakes.
- Cups and studs installed.

Order No.	Mfg. No. / Description	List Price
657310	(81004)	\$145.19

Hydraulic Drum Brake Flush Kit



- Stop saltwater corrosion of drum brake components.
- This kit adapts to all hydraulic drum brake trailers and is easy to install and easy to use.
- One flush kit is required per axle.
- Includes: Tubing, drum brake assembly connectors and mounting clips.

Order No.	Mfg. No. / Description	List Price
5765070	(81107)	\$102.19

Eliminator Vented Rotor Pads



- Organic material brake pads for 10" and 12" disc brakes, caliper #46304.
- Kit is for one axle.

Order No.	Mfg. No. / Description	List Price
5765117	(82084)	\$75.89

Drum Wheel Cylinder Kit



- Aluminum wheel cylinders for 10" or 12" hydraulic drum brakes.
- 2 per pack

Order No.	Mfg. No. / Description	List Price
5765040	(80994)	\$109.09

Freebacking Shoe Lining Kit



- Hydraulic 10" brake shoes, GalvX coated Left and Right brake pads only, no hardware included.

Order No.	Mfg. No. / Description	List Price
5765071	(81108)	\$92.89

Non-Chlorinated Brake Cleaner



- Low V.O.C. formula.
- Quickly and effectively dissolves and removes grease, oil, brake fluid and other contaminants from brakes, C.V. joints and clutch components.
- Helps stop brake squealing and can improve braking performance.
- 14 oz.

LIMITED QUANTITIES

Order No.	Mfg. No. / Description	List Price
604320	(4620)	\$7.19

Brakleen® Brake Parts Cleaner



- Formulated to quickly and effectively remove grease, brake dust, brake fluids, oils and other contaminants from brake parts, lining, pads.
- For: ABS, disc, drum, brake cylinders, brake drums, brake linings, brake shoes, calipers, clutch discs, disc brake pads, discs.
- Safe for use on all brake systems including: Springs & Wedge brakes.
- 19 oz.

Order No.	Mfg. No. / Description	List Price
2899068	(05089)	\$8.69

Brakleen® Brake Parts Cleaner - Non-Chlorinated



- Formulated to quickly remove brake fluid, grease, oil and other contaminants from brake linings & pads.
- For: ABS, discs, drum, brake cylinders, brake drums, brake linings, brake shoes, calipers, clutch discs, disc brake pads.
- Safe for use on all brake systems including: Springs & Wedge brakes.
- 14 oz.

Order No.	Mfg. No. / Description	List Price
2899066	(05084)	\$5.99

Trailer Slipper Spring - Radius End



- Replacement trailer springs: Heavy duty spring steel.
- Includes: 9/16" ID nylon bushings.
- 24-5/8" end to end. Arch depth 4". Arch length 23-1/2".
- Bulk.

Order No.	Mfg. No. / Description	List Price
5765089	(81187) 500# Capacity (Per Spring)	\$45.99

Trailer Double-Eye Spring



- Replacement trailer springs: Heavy duty spring steel.
- Includes: 9/16" ID nylon bushings.
- Eye to eye slipper length: 25-1/4". Leaf spring height: 3". Leaf spring width: 1-3/4".
- Front divisional length: 12-5/8".
- Leaf spring leaf count: 4.
- Bulk.

Order No.	Mfg. No. / Description	List Price
1671199	(81199) 2,600# Capacity (Per Spring)	\$183.99

SLIPPER SPRING - FLAT END

DMI #	MFG #	Leaf Springs	Length	Capacity	List Price	
667898	(UNA-267)	3	24-1/2"	850 lbs.	\$51.89	F0-2363000
667886	(UNA-043)	4	24-1/2"	1,000 lbs.	\$63.89	F0-2744000
667901	(UNA-013)	2	25-1/8"	470 lbs.	\$39.99	F0-9972000
667913	(UNA-014)	3	25-1/8"	705 lbs.	\$53.99	F0-9773000
667925	(UNA-015)	4	25-1/8"	940 lbs.	\$65.29	F0-0754000
667937	(UNA-016)	5	25-1/8"	1,184 lbs.	\$80.69	F0-8465000
667949	(UNA-017)	6	25-1/8"	1,415 lbs.	\$93.39	F0-7356000
668028	(UNA-038)	2	30"	880 lbs.	\$71.59	F0-1105000
668030	(UNA-039)	3	30"	1,430 lbs.	\$86.29	F0-0406000
668054	(UNA-040)	4	30"	1,837 lbs.	\$112.29	F0-0687000

SLIPPER SPRING - RADIUS END

DMI #	MFG #	Leaf Springs	Length	Capacity	List Price	
667874	(UNA-034)	3	32"	800 lbs.*	\$75.59	F0-1925000
668131	(UNA-024)	4	32"	1,100 lbs.*	\$85.59	F0-1995000
668155	(UNA-029)	5	32"	1,400 lbs.*	\$105.09	F0-6537000

DOUBLE EYE SPRING

DMI #	MFG #	Leaf Springs	Length	Capacity	List Price	
668206	(UNA-219)	3	25-1/4"	1,250 lbs.*	\$53.59	F0-1573000
668220	(UNA-212)	4	25-1/4"	1,830 lbs.*	\$68.79	F0-5184000
668207	(UNA-220)	3	25-1/4"	2,000 lbs.*	\$64.59	F0-1254000
668205	(UNA-218)	4	25-1/4"	2,500 lbs.*	\$79.49	F0-4655000

Trailer Springs



Slipper Spring - Flat End



Slipper Spring - Radius End



Double Eye Spring

*The capacities given are for reference, only. The actual capacity is dependent on the spring mounting (center clamp) and service requirements.

Rear Spring Hanger



- Solid steel hangers can be used on rear slipper springs 1-3/4" to 2" wide.
- 5,200 lb. to 8,000 lb. capacity, medium duty axles.
- 1/4" stock.

Order No.	Mfg. No. / Description	List Price	
578181	(86275)	\$5.89	F0-2140000

Front Spring Hanger



- Solid steel stock hangers for use on slipper and double eye springs that are mounted on 1,000 lb. - 3,500 lb. capacity, medium duty axles.
- Predrilled for 9/16" bolt.

Order No.	Mfg. No. / Description	List Price	
578166	(86274)	\$5.89	F0-2140000

Shackle Link



- Zinc plated shackle link.
- Holes are 2-1/8" OC.

Order No.	Mfg. No. / Description	List Price	
578194	(86276)	\$6.09	F0-6240000

Nylon Spring Bushings

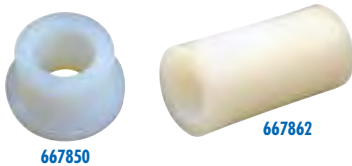

667850

667862

- 7/8" OD. 1/2" ID.

Order No.	Mfg. No.	Length	List Price	
667850	(PE-182) End	11/16"	\$2.19	F0-3510000
667862	(PE-224) Center	1-3/4"	\$1.19	F0-3800000

Fluted Shackle Bolt with Nut



- Zinc plated Grade 5 steel.
- For use with spring hanger brackets.
- Fluting prevents the bolt from turning, which can wear hanger brackets.
- 9/16" x 3" bolts with nuts.
- Sold 2 per pack.

Order No.	Mfg. No. / Description	List Price	
578368	(86250)	\$8.99	F0-9260000

Universal Axle Tie Plates - Galvanized



- Plate designed to fit 1.90", 2" and 2-3/8" wide square and round axle bolt patterns.
- Sold per pair.

Order No.	Mfg. No. / Description	List Price	
576554	(81186)	\$14.39	F0-7001000

Trailer Axle Spindles



580111

580173

- Features stainless steel wear sleeve.
- Includes: Nut, washer and cotter pin.

Order No.	Mfg. No. / Description	Bearing Surface	List Price	
580111	(80055) 1-1/4" x 7"	1"	\$33.19	F0-3232000
580123	(80060) 1-1/4" x 7"	1-1/16"	\$33.19	F0-3232000
580147	(80235) 1-3/4" x 8-1/4"	1-1/16" x 1-3/8"	\$43.59	F0-1503000
580159	(80325) 2" x 8-1/4"	1-1/16" x 1-3/8"	\$47.89	F0-2533000
580173	(81169) Nut, Washer and Cotter Pin Kit for 1" Spindle		\$7.19	F0-3050000

Axle Tie Plate Kits

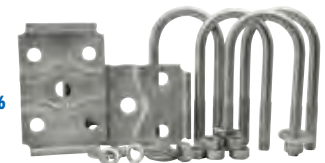

576516

- Galvanized plate finish.
- Kits include: (4) U-bolts, (8) lock washers, (8) flat washers, (8) hex nuts and (2) five hole tie plates.

Order No.	Mfg. No. / Description	List Price	
576504	(81175) Fits 1.90" Round Axles	\$38.49	F0-4962000
576516	(81180) Fits 2-3/8" Round Axles	\$47.79	F0-5433000
576530	(81185) Fits 2" Square Axles	\$58.19	F0-3704000



SPECIAL HANDLING MAY APPLY



- Electronics
- Trolling Motors
- Instruments
- Electrical
- Lighting
- Anchor & Dock
- Safety
- Steering, Controls
- Pumps
- Fuel System
- Seating & Pedestals
- Trailer
- Tops & Covers
- Perform.
- Propellers
- Engine & Care
- Cleaning & Care
- Paint & Paint Acc.
- Fun & Flotation
- Topside Acc.
- Cockpit & Deck
- Hardware, Fasteners
- Camouflage
- Misc.
- Comm.

O'Neill Manufacturing/Rod Saver Personalized Tie Downs

Secure your future with Rod Saver and Donovan Marine.

- O'Neill Manufacturing, Inc. and Donovan Marine offers two of O'Neill's most popular tie downs with your dealership name embroidered on the buckle wrap.
- Choose from the Paddle Buckle or Quick Release over-the-center style buckles.



Information Needed:

Monogram Name (20 letters or less):

Letter Style #:

Thread Color:

Choose from: Red Dark Blue Light Blue White Yellow Green Chartreuse Green Tan

Letter Style Choices:

Style #	Description	Example
1	Block	ABDCEFGHIJKLMNOPQRSTUVWXYZabcdefghijklmnopqrstuvw
2	Sea Breeze	<i>ABDCEFGHIJKLMNOPQRSTUVWXYZabcdefghijklmnopqrstuvw</i>
3	Old Style	ABDCEFGHIJKLMNOPQRSTUVWXYZabcdefghijklmnopqrstuvw
4	Script	<i>ABDCEFGHIJKLMNOPQRSTUVWXYZabcdefghijklmnopqrstuvw</i>
5	Flares	ABDCEFGHIJKLMNOPQRSTUVWXYZabcdefghijklmnopq
6	Chancery	<i>ABDCEFGHIJKLMNOPQRSTUVWXYZabcdefghijklmnopq</i>
7	Hobo	ABDCEFGHIJKLMNOPQRSTUVWXYZabcdefghijklmnopq
8	Old English	ABDCEFGHIJKLMNOPQRSTUVWXYZabcdefghijklmnopq
9	Serif3	ABDCEFGHIJKLMNOPQRSTUVWXYZabcdefghijklmnopq



Paddle Buckle



Quick Release

Order No.	Mfg. No. / Description	Size	Per Pair	Price
	(2PB2) Paddle Buckle	2" W x 2' L	Per Pair	Price on Request
	(2PB4) Paddle Buckle	2" W x 4' L	Per Pair	Price on Request
	(QRTD2) Quick Release	2" W x 2' L	Per Pair	Price on Request
	(QRTD4) Quick Release	2" W x 4' L	Per Pair	Price on Request

Star Brite Custom Embroidered Transom Tie Downs



Special Order Only Minimum Order 25 Pair

- Thread color choices: Red, blue, white, yellow, gold, teal, and neon green.
- No additional charge for standard or script type lettering.
- No more than 13 characters per line, imprint area 2" x 3", three imprint line available.
- Custom digitized logos available.

Order No.	Mfg. No. / Description	Price
S/O	(60070) 2" x 2' Transom Tie Down, Bulk	Price on Request
S/O	(60062) 2" x 3' Transom Tie Down, Bulk	Price on Request
S/O	(60072) 2" x 4' Transom Tie Down, Bulk	Price on Request
S/O	(60079) 2" x 5' Transom Tie Down, Bulk	Price on Request

Ratchet Tie Down Strap with S-Hooks



- Heavy duty 1" wide webbing.
- Easy-adjust ratchet.
- Breaking strength: 1,700 lbs.
- Loads up to 566 lbs.
- Coated S-hooks.
- Sold each.

Order No.	Description	List Price	Mfg. No.
7-2136	Length 14'	\$7.89	FO-2550000

Deluxe Gunwale Tie Downs

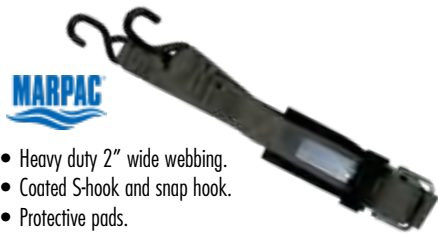

- Heavy duty 2" wide webbing.
- Coated S-hook and snap hook.
- Protective pads.
- Breaking strength: 1,500 lbs. Loads up to 500 lbs.
- Made in USA.
- Sold each.

Order No.	Description	List Price	Mfg. No.
7-2121	Length 10'	\$20.09	FO-6041000
7-2122	Length 12'	\$21.69	FO-8151000
7-2123	Length 14'	\$21.99	FO-9351000
7-2124	Length 16'	\$22.59	FO-1851000

Ratchet Tie Down Strap with S-Hooks



- Heavy duty 2" wide polyester webbing.
- Quick release buckle.
- Fully adjustable.
- Breaking strength: 1,800 lbs. Loads up to 600 lbs.
- Coated S-hooks.
- Sold each.

Order No.	Description	List Price	Mfg. No.
7-59802	Length 14'	\$12.79	FO-5980000

- Electronics
- Trolling Motors
- Instruments
- Electrical
- Lighting
- Anchor & Dock
- Safety
- Steering, Controls
- Pumps
- Fuel System
- Seating & Pedestals
- Trailer
- Tops & Covers
- Perform.
- Propellers
- Engine & Care
- Cleaning & Care
- Paint & Paint Acc.
- Fun & Flotation
- Topside Acc.
- Cockpit & Deck
- Hardware, Fasteners
- Camouflage
- Misc.
- Comm.

Adjustable Transom Tie Down with S-Hooks



- Heavy duty 1" wide webbing.
- Easy-adjust ratchet.
- Protective pad.
- Breaking strength: 1,700 lbs. Loads up to 566 lbs.
- Coated S-hooks.
- Sold in pairs.

Order No.	Description	List Price	
7-2133	Length 3.5'	\$13.29	FO-0390000

Adjustable Transom Tie Down with S-Hooks



- High impact 2" wide webbing.
- Quick release buckle.
- Fully adjustable.
- Breaking strength: 750 lbs. (per pair). Loads up to 250 lbs. (per pair).
- Coated S-hooks.
- Sold in pairs.

Order No.	Description	List Price	
7-59784	Length 2'	\$15.89	FO-2111000
7-59810	Length 4'	\$16.69	FO-8611000

Heavy Duty Retractable Transom Tie Down Includes Ratchet



- Unique ratcheting action has two-step release to prevent accidental release.
- Heavy duty 2" wide webbing.
- Quick release buckle.
- Breaking strength: 3,300 lbs.
- Loads up to 1,100 lbs.
- Mounting hardware included.
- Made in USA.
- Sold in pairs.

Order No.	Description	List Price	
7-2140	Length 40"	\$88.29	FO-0816000

Deluxe Trailer Tie Down



- 2" wide webbing.
- Over-center locking buckle with wrap around buckle protection that is proven to stay clamped under the worst road conditions.
- Heavy vinyl coated top hook and zinc plated bottom hook.
- Rated capacity: 1,700 lbs.
- Sold in pairs.

Order No.	Mfg. No. / Description	List Price	
2003840	(TTD2) Length 2'	\$40.89	FO-2682000
2003845	(TTD4) Length 4'	\$42.89	FO-2003000

Paddle Buckle Tie Down



- Made with a paddle buckle, polypropylene belt and protective pad with hook and loop closure for boat protection.
- Heavy vinyl coated top hook and zinc plated bottom hook.
- Rated capacity for 2": 1,000 lbs.
- Rated capacity for 1": 750 lbs.
- Sold in pairs.

Order No.	Mfg. No. / Description	List Price	
2003760	(1PB4) 1" W x 4' L	\$29.99	FO-9902000
2003765	(2PB2) 2" W x 2' L	\$33.09	FO-6132000
2003775	(2PB4) 2" W x 4' L	\$34.19	FO-3932000
2003785	(2PB6) 2" W x 6' L	\$35.19	FO-3642000

Retractable Transom Tie Down



- 2" wide webbing.
- Swivels to ensure that webbing is pulled in a straight line to the boat transom eye.
- It also features an easy squeeze release mechanism, which enables you to quickly and conveniently secure the boat.
- Rated capacity: 1,800 lbs.
- Sold in pairs.

Order No.	Mfg. No. / Description	List Price	
2003820	(RT40) Length 4'	\$112.69	FO-8887000

Transom Tie Down with Quick Release Buckle



- 2" wide webbing.
- Polypropylene webbing with coated S-hooks and velcro closure.
- Rated capacity: 1,200 lbs.
- Safe working load: 400 lbs.

Order No.	Mfg. No. / Description	List Price	
3259639	(60065) Length 4'	\$34.29	FO-0042000

Ratchet Transom/Utility Tie Down



- 1" wide webbing.
- Vinyl coated S-hooks.
- Protective web pads.
- Breaking strength: 1,200 lbs. SWL: 400 lbs.
- Sold in pairs.

Order No.	Mfg. No. / Description	List Price	
202503	(F14209) Length 3.5'	\$22.19	FO-3551000

Kwik-Lok Transom Tie Down



- 2" wide polypropylene webbing.
- Vinyl coated top-hooks.
- Zinc coated trailer hooks.
- Protective web pads.
- Breaking strength: 1,200 lbs. SWL: 400 lbs.
- Sold in pairs.

Order No.	Mfg. No. / Description	List Price	
2093111	(F13111) Length 4'	\$24.99	Z0-0000000

Pro Series Ratchet Transom Tie Down



- 1" wide nylon webbing.
- Molded SUR-Grip handle for greater ease in ratcheting.
- Vinyl coated top-hooks. Zinc coated trailer hooks.
- Protective web pads.
- Breaking strength: 1,200 lbs. SWL: 400 lbs.
- Sold in pairs.

Order No.	Mfg. No. / Description	List Price	
2098740	(F18740) Length 3.5'	\$32.09	Z0-0000000



- Electronics
- Trolling Motors
- Instruments
- Electrical
- Lighting
- Anchor & Dock
- Safety
- Steering, Controls
- Pumps
- Fuel System
- Seating & Pedestals
- Trailering
- Tops & Covers
- Perform.
- Propellers
- Engine & Care
- Cleaning & Care
- Paint & Paint Acc.
- Fun & Flotation
- Topside Acc.
- Cockpit & Deck
- Hardware, Fasteners
- Camouflage
- Misc.
- Comm.

Pro Series Kwik-Lok Transom Tie Down



BoatBuckle

- 2" wide webbing.
- SUR-Grip Kwik-Lok buckle for maximum comfort.
- Vinyl coated top-hooks. Zinc coated trailer hooks.
- Hi-Vis protective PVC pads.
- Night Eyes reflective closure patch.
- Breaking strength: 1,200 lbs. SWL: 400 lbs.
- Sold in pairs.

Order No.	Mfg. No. / Description	List Price	
2097631	(F17631) Length 2'	\$36.69	Z0-0000000
2097632	(F17632) Length 4'	\$38.39	Z0-0000000

Mini Retractable Transom Tie Down



BoatBuckle

- 1" high quality, polyester web.
- Permanent one-bolt installation.
- Self-retracting web.
- Anti-corrosive construction.
- Dual safety lock security.
- Breaking strength: 1,400 lbs. SWL: 466 lbs.
- Sold in pairs.

Order No.	Mfg. No. / Description	List Price	
202604	(F106877) Length 6'	\$80.59	F0-1465000

Retractable Transom Tie Down



BoatBuckle

- 2" high quality, polyester web.
- Permanent one-bolt installation.
- Self-retracting web.
- Anti-corrosive construction.
- Adapts to most mounting angles.
- Breaking strength: 2,500 lbs. SWL: 833 lbs.
- Sold in pairs.

Order No.	Mfg. No. / Description	List Price	
2000939	(F08893) Length 43"	\$104.89	F0-2437000

Retractable Transom Tie Down



BoatBuckle

- 2" high quality, polyester web.
- Stainless steel.
- Permanent one-bolt installation.
- Self-retracting web.
- Anti-corrosive construction.
- Adapts to most mounting angles.
- Breaking strength: 1,500 lbs. SWL: 500 lbs.
- Sold in pairs.

Order No.	Mfg. No. / Description	List Price	
202666	(F14256) Length 43"	\$154.99	F0-9480100

PWC Tri-Down with Soft Hook

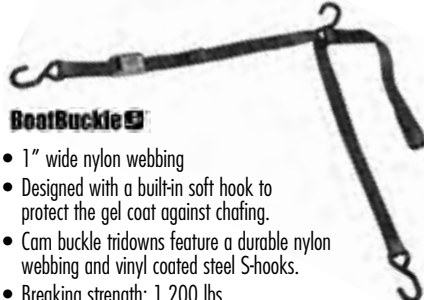

BoatBuckle

- 1" wide nylon webbing
- Designed with a built-in soft hook to protect the gel coat against chafing.
- Cam buckle tri-downs feature a durable nylon webbing and vinyl coated steel S-hooks.
- Breaking strength: 1,200 lbs.
- SWL: 400 lbs.
- Sold each.

Order No.	Mfg. No. / Description	List Price	
2090972	(F10972BK) Length 6'	\$18.79	Z0-0000000

Universal Mounting Bracket



BoatBuckle

- For flexible mounting options.
- For use with BoatBuckle Retractable Ratchet Tie Downs in 1" or 2" transom or bow models.
- Breaking strength: 5,000 lbs.

Order No.	Mfg. No. / Description	List Price	
2000942	(F14254)	\$12.69	F0-8880000

Trailer Safety Chains



- Zinc plated.
- Length 31".
- S-hooks with latch on both ends.
- Sold in pairs.

Order No.	SAE Class (GTW Rating)	Diameter	Links	List Price	
7-1850	Class II (3,200 lbs.)	3/16"	28 Links	\$8.79	F0-5160000
7-1851	Class III (5,200 lbs.)	1/4"	26 Links	\$11.89	F0-2380000



- Zinc plated.
- Contains S-hooks.
- Class IV. 5/16" x 26 links.
- Overall length 40-3/4".
- Sold in pairs.

Order No.	Mfg. No. / Description	List Price	
333574	(81204)	\$41.89	F0-2392000



Python™ Adjustable Locking Cable



Master Lock

- Patented adjustable locking mechanism holds cable tight at any position for perfect fit.
- Braided steel for strength and flexibility.
- Cable end threads through places other cables cannot.
- Integrated pin tumbler keyed locking mechanism for superior pick resistance.
- Rust resistant lock and vinyl coated cable for superior weather and scratch resistance.
- Strap holds excess cable for compact storage.

Order No.	Mfg. No. / Description	List Price	
2001304	(8418D)	\$26.29	G0-1671000

LIMITED QUANTITIES

Galvanized Hitch Cable



- Replace your noisy chains with self-coiling hitch cables.
- Galvanized aircraft cable construction.
- Exceeds SAE J684 standards for trailer coupling and automotive type hitches.
- Length 36".
- Class III.
- Capacity: 5,000 lbs.
- Includes wire safety latches.
- Sold in pairs.

Order No.	Mfg. No. / Description	List Price	
5765027	(59539)	\$32.09	F0-6422000

- Electronics
- Trolling Motors
- Instruments
- Electrical
- Lighting
- Anchor & Dock
- Safety
- Steering, Controls
- Pumps
- Fuel System
- Seating & Pedestals
- Trailer
- Tops & Covers
- Perform.
- Propellers
- Engine & Care
- Cleaning & Care
- Paint & Paint Acc.
- Fun & Flotation
- Topside Acc.
- Cockpit & Deck
- Hardware, Fasteners
- Camouflage
- Misc.
- Comm.

Galvanized Hitch Cables (Black Vinyl Jacketed)



- Replace your noisy chains with self-coiling hitch cables.
- Galvanized aircraft cable construction.
- Exceeds SAE J684 standards for trailer coupling and automotive type hitches.
- Length 36".
- Sold in pairs.

WIRE SAFETY LATCH

Order No.	Mfg. No. / Description	Capacity	List Price	Part No.
579613	(59537) Class II	Capacity 3,500 lbs.	\$30.19	F0-3112000
579620	(59541) Class III	Capacity 5,000 lbs.	\$32.79	F0-5922000

SAFETY LATCH HOOK

Order No.	Mfg. No. / Description	Capacity	List Price	Part No.
5765030	(59548) Class IV	Capacity 7,000 lbs.	\$45.49	F0-4813000

"S" Hook Chain Keepers



- Patented safety chain keepers attach easily to the "S" hooks to keep your chains secured to the vehicle.
- Required in some states.
- Packed 2 per package.

Order No.	Mfg. No. / Description	List Price	Part No.
579630	(81255)	\$6.69	F0-8640000

Bow Safety Chain with S-Hook



- Zinc plated.
- Diameter 3/16", length 12".
- Breaking strength: 3,200 lbs.
- Includes: 12 links and S-hook with latch on one end.

Order No.	Description	List Price	Part No.
7-1852	Bow Safety Chain	\$9.29	F0-0560000

Couplers



- Zinc plated Tuffplate finish.
- Exclusive Quick-Lock ball clamp assembly can be easily adjusted without tools.

NEW MODEL

Order No.	Mfg. No. / Description	Capacity	Ball Size	List Price	Part No.
685650	(13628) SAE Class 1 Tongue: 2-1/2"	2,000 lbs.	1-7/8"	\$25.89	F0-2181000
685566	(13728) SAE Class 1 Tongue: 3"	2,000 lbs.	1-7/8"	\$26.49	F0-4581000
388377	(13885) SAE Class 2 Tongue: 3"	3,500 lbs.	2"	\$41.99	F0-9392000
685569	(13897) SAE Class 3 Tongue: 3"	5,000 lbs.	2"	\$33.39	F0-7332000

Couplers



- Zinc plated.

NEW PRODUCT

Order No.	Class Rating	Gross Trailer Weight	Ball Size	Channel Width	List Price	Part No.
7-1890	SAE Class I	2,000 lbs.	1-7/8"	2"	\$16.99	F1-9811000
7-1891	SAE Class I	2,000 lbs.	1-7/8"	3"	\$19.99	F1-9931000
7-1893	SAE Class II	3,500 lbs.	2"	2-1/2"	\$19.99	F1-9931000
7-1894	SAE Class II	3,500 lbs.	2"	3"	\$19.99	F1-9931000
7-1895	SAE Class III	5,000 lbs.	2"	3"	\$21.99	F1-9351000

Coupler Repair Kit



- Repair kit for Class 2 and 3 couplers.
- Zinc plated Tuffplate finish.
- Includes the entire ball clamp assembly (locking lever with pin and chain, light spring, ball clamp, heavy spring, channel lock, and nut) for quick changeout.

NEW PRODUCT

Order No.	Mfg. No. / Description	List Price	Part No.
388416	(13970)	\$23.99	F0-9761000

Coupler Repair Kit



- Zinc plated.
- Fits 1-7/8" and 2" ball couplers.

NEW PRODUCT

Order No.	Description	List Price	Part No.
7-1898	Coupler Repair Kit	\$11.49	F1-4080000

Trailer Coupler Latch Lock



- 3-1/2" long shackle fits UFP couplers.
- Hardened steel for improved cut and shear resistance.
- K1 key blank.

Order No.	Mfg. No. / Description	List Price	Part No.
2001274	(1471DAT)	\$26.59	G0-2871000

Trailer Coupler Lock



- Fits 1-7/8", 2" and most 2-5/16" trailer couplers.
- Advance locking mechanism resists picking and prying.
- Easy to install and remove.
- Resists rust and corrosion.

Order No.	Mfg. No. / Description	List Price	Part No.
2001294	(377DAT)	\$61.69	G0-3314000

Trailer Coupler Lock



- Helps prevent trailer theft.
- Will not rust, corrode or clog.
- Fits all standard couplers.

Order No.	Description	List Price	Part No.
7-0899	Trailer Coupler Lock	\$9.39	F0-7560000

- Electronics
- Trolling Motors
- Instruments
- Electrical
- Lighting
- Anchor & Dock
- Safety
- Steering, Controls
- Pumps
- Fuel System
- Seating & Pedestals
- Trailering
- Tops & Covers
- Perform.
- Propellers
- Engine & Care
- Cleaning & Care
- Paint & Paint Acc.
- Fun & Flotation
- Topside Acc.
- Cockpit & Deck
- Hardware, Fasteners
- Camouflage
- Misc.
- Comm.

Bump Me Coupler Cushion



- Fits most brands of Class 1, 2, 3, and 4 couplers.
- Molded with U.V. inhibitor.
- Protects your vehicle bumper, tailgate, license plate, and shins by absorbing blow between coupler and towing vehicle when hook-up is misjudged.
- Slips onto the coupler flange, no tools required.

NEW PRODUCT

Order No.	Mfg. No. / Description	List Price	
388430	(13352)	\$23.99	FO-9761000

Coupler Locking Pin



- Zinc plated steel.
- Quick connect and disconnect.
- Used to insure coupler does not disengage.
- Fits 2" and 3" couplers.
- Length 3", diameter 1/4".

Order No.	Description	List Price	
7-0895	Coupler Locking Pin	\$2.89	FO-2020000

Coupler Locking Pin



- Solid zinc-plated steel.
- Quick connect and disconnect, to keep coupler from accidentally disengaging.
- Fits 2" and 3" couplers.
- Pin fits through coupler release handle to provide security and safety.
- Dimensions: 2-1/4" W x 1-5/8" L.

NEW PRODUCT

Order No.	Mfg. No. / Description	List Price	
1141029	(11029-6)	\$4.29	FO-0030000

Coupler Safety Pin



- Zinc plated.
- Rounded.
- Quick connect and disconnect.
- Used to insure coupler does not disengage.

Order No.	Description	List Price	
7-59401	Coupler Safety Pin	\$2.19	FO-3510000

Trailer Hitch Balls



- Chrome plated steel. Includes lock washer and nut.
- V-5 compliant.
- Independently tested to SAE J684 specs.

Order No.	Ball Diameter	Shaft	Rated for:	List Price	
7-0145	1-7/8"	3/4" x 2-3/8"	2,000 lbs.	\$11.89	FO-2380000
7-0147	1-7/8"	1" x 2-1/8"	2,000 lbs.	\$12.89	FO-2090000
7-0146	2"	3/4" x 2-3/8"	3,500 lbs.	\$12.09	FO-6480000
7-0148	2"	1" x 2-1/8"	6,000 lbs.	\$13.19	FO-3290000
7-0152	2-5/16"	1" x 2-1/8"	6,000 lbs.	\$17.09	FO-6911000

Complete Towing Kit



- Towing kit includes: Ball mount, trailer ball and hitch pin.
- 2" powder coated drop ball mount.
 - Handles trailers up to 6,000 lbs.
 - Maximum tongue weight up to 600 lbs.
 - Use with 2" x 2" receiver.
- 2" trailer ball rated at 6,000 lbs., 1" shaft diameter.
- 5/8" hitch pin.
- Convenient storage case included.

Order No.	Description	List Price	
7-1869	Complete Towing Kit	\$39.99	FO-9972000

Ball Mounts



- Powder coated.
- Note: Trailer ball and hitch pin sold separately.

CLASS II

- Fits 1-1/4" receivers. Length 7".
- Use with any trailer ball with 3/4" shank diameter.
- Drop 2-1/2", rise 2-1/8".
- Tongue weight: 300 lbs. Gross trailer weight: 3,500 lbs.

Order No.	Description	List Price	
7-1660	Ball Mount	\$21.79	GO-0641000

CLASS IV

- Fits 2" receivers. Length 8".
- Use with any trailer ball with 1" shank diameter.
- Tongue weight: 600 lbs. Gross trailer weight: 6,000 lbs.

Order No.	Description	List Price	
7-1662	Drop 2", Rise 3/4"	\$22.49	GO-7051000
7-1664	Drop 4", Rise 2-3/4"	\$28.09	GO-2881000

Tri-Ball Hitch



- Solid powder coated shank for heavy duty towing.
- Fits 2" receivers.
- Length 7".
- 5/8" hitch pin hole (hitch pin sold separately).
- Versatile mount includes: 1-7/8", 2" and 2-5/16" chrome trailer balls.
- Rated for: 2,000 lb. (1-7/8"), 6,000 lb. (2") and 10,000 lb. (2-5/16") GTW.

Order No.	Description	List Price	
7-1666	Tri-Ball Hitch	\$82.49	GO-7255000

Trailer Drop Hitch - Adjustable



- Made from 6061 aluminum.
- Fits 2" receivers.
- Includes: 2" and 2-5/16" trailer balls.
- Adjustable drop: 6".
- Shank hole: 5/8".
- Tongue weight: 1,000 lbs. Gross trailer weight: 10,000 lbs.

Order No.	Description	List Price	
7-1669	Trailer Drop Hitch	\$150.29	FO-0250100

Electronics

Trolling Motors

Instruments

Electrical

Lighting

Anchor & Dock

Safety

Steering, Controls

Pumps

Fuel System

Seating & Pedestals

Trailer

Tops & Covers

Perform.

Propellers

Engine & Care

Cleaning & Care

Paint & Paint Acc.

Fun & Flotation

Topside Acc.

Cockpit & Deck

Hardware, Fasteners

Camouflage

Misc.

Comm.

Hitch Pin with R-Clip Cotter Pin



- Zinc plated.
- Corrosion resistance.
- Pin diameter 5/8".
- Usable length 3".
- Fits Class III and Class IV hitches (2" x 2").

Order No.	Description	List Price	
7-1868	Hitch Pin	\$5.09	F0-6530000

Receiver Pin and Clip



- Chrome plated.
- Hardened steel for improved cut and shear resistance.
- Fits both 1/2" and 5/8" receivers.
- Usable length of receiver pin is 3".
- 1/2" pin is rated for Class I/II and 5/8" pin is rated for Class III/IV.
- Tapered ends for easy insertion.

Order No.	Mfg. No. / Description	List Price	
2001271	(1414DAT)	\$9.19	GO-6160000

Barrel Head Hitch Pin



- Stainless steel for corrosion resistance.
- Stainless steel hitch pin fits 5/8" receivers.
- Usable length of receiver pin is 3".
- Class III/IV rating.
- Tapered ends for easy insertion.

Order No.	Mfg. No. / Description	List Price	
2001272	(1465DAT)	\$16.19	GO-5801000

Barrel Head Hitch Pin



- Chrome plated.
- Fits 5/8" receivers.
- Class III/IV rating.
- Usable length of receiver pin is 3".
- Tapered ends for easy insertion.
- Hardened steel for improved cut and shear resistance.

Order No.	Mfg. No. / Description	List Price	
2001277	(1495DAT)	\$8.09	GO-2450000

Hitch Lock



- Chrome plated for corrosion resistance.
- Fits Class III and Class IV hitches (2" x 2").
- Key slot cover protects lock mechanism.
- Pin diameter: 5/8".

Order No.	Description	List Price	
7-1867	Locking Receiver Pin	\$12.69	F0-8880000

Hitch Receiver Locking Pin



- Chrome plated for corrosion resistance.
- Safety and security, helps prevent thefts.
- Fits Class III and Class IV hitches (2" x 2").
- Key slot cover protects lock mechanism.
- Pin diameter: 5/8".

Order No.	Description	List Price	
7-1866	Hitch Lock	\$13.79	F0-5690000

Stainless Steel Receiver Lock



- Stainless steel keyed alike receiver lock and coupler latch lock.
- 5/8" receiver lock has Push to Lock locking mechanism.
- Usable length of receiver pin is 2-3/4".
- Weather tough seal and water tight cap protects lock from moisture and dirt.
- Adjustable coupler latch lock; locks from 9/16" to 2-3/4".
- K1 Key Blank.

Order No.	Mfg. No. / Description	List Price	
2001276	(1481DAT)	\$50.49	GO-3833000

Galvanized Plain Wheel



506344

505457



BIAS PLY TRAILER TIRE

Order No.	Mfg. No. / Description	List Price	
505202	(30010) 480 8" B Ply 4 Lugs	\$55.99	F0-9193000
505214	(30030) 480 8" B Ply 5 Lugs	\$55.99	F0-9193000
505457	(3H440) 205/65 10" D Ply 5 Lugs	\$169.89	F0-2981100

BIAS PLY TRAILER TIRE - WIDE PROFILE

Order No.	Mfg. No. / Description	List Price	
506344	(3H490) 205/65 10" E Ply 5 Lugs	\$164.09	F0-6841100

Galvanized Mod Wheel



BIAS PLY TRAILER TIRE

Order No.	Mfg. No. / Description	List Price	
505303	(3S160) ST175/80D 13" C Ply 5 Lugs	\$143.19	F0-3200100
505308	(31242) ST175/80D 13" D Ply 5 Lugs	\$156.09	F0-6290100
505350	(3S430) ST205/75D 14" C Ply 5 Lugs	\$182.49	F0-4772100
505355	(3S570) ST215/75D 14" C Ply 5 Lugs	\$205.29	F0-0734100

RADIAL PLY TRAILER TIRE

Order No.	Mfg. No. / Description	List Price	
505315	(31952) ST175/80R 13" C Ply 5 Lugs	\$167.29	F0-0171100
505193	(32188) ST215/75R 14" C Ply 5 Lugs	\$237.19	F0-3066100



SPECIAL HANDLING MAY APPLY



- Electronics
- Trolling Motors
- Instruments
- Electrical
- Lighting
- Anchor & Dock
- Safety
- Steering, Controls
- Pumps
- Fuel System
- Seating & Pedestals
- Trailering
- Tops & Covers
- Perform.
- Propellers
- Engine & Care
- Cleaning & Care
- Paint & Paint Acc.
- Fun & Flotation
- Topside Acc.
- Cockpit & Deck
- Hardware, Fasteners
- Camouflage
- Misc.
- Comm.

Galvanized Spoke Wheel



BIAS PLY TRAILER TIRE

Order No.	Mfg. No. / Description	List Price	
505240	(30550) 480 12" B Ply 4 Lugs	\$90.79	F0-5536000
505252	(30590) 480 12" B Ply 5 Lugs	\$90.79	F0-5536000
505264	(30710) 530 12" 4 Ply 4 Lugs	\$104.09	F0-6827000
505276	(30750) 530 12" 4 Ply 5 Lugs	\$104.09	F0-6827000
505288	(3S040) ST175/80D 13" B Ply 4 Lugs	\$136.09	F0-6259000
1072924	(3S143) ST175/80D 13" C Ply 5 Lugs	\$154.99	HO-9929000
505309	(3S334) ST185/80D 13" D Ply 5 Lugs	\$167.79	F0-5471100
505335	(3S450) ST205/75D 14" C Ply 5 Lugs	\$182.39	F0-7672100
505341	(3S650) ST205/75D 15" C Ply 5 Lugs	\$178.09	F0-6642100
505357	(3S560) ST215/75D 14" C Ply 5 Lugs	\$205.19	F0-3634100
505358	(3S865) ST225/75D 15" D Ply 5 Lugs	\$226.69	F0-8685100
505400	(3S880) ST225/75D 15" D Ply 6 Lugs	\$228.29	F0-0895100
505428	(3S005) ST235/80R 16" D Ply 6 Lugs	\$396.39	F0-7477200
505359	(34806) ST235/80R 16" E Ply 6 Lugs	\$410.29	F0-0278200
505430	(34906) ST235/80R 16" E Ply 8 Lugs	\$387.69	F0-8317200

RADIAL PLY TRAILER TIRE

Order No.	Mfg. No. / Description	List Price	
505327	(32008) ST185/80R 13" D Ply 5 Lugs	\$167.79	F0-5471100
505192	(32156) ST205/75R 14" C Ply 5 Lugs	\$224.29	F0-0075100
505187	(32182) ST205/75R 14" C Ply 5 Lugs	\$236.99	F0-9856100
505418	(32666) ST225/75R 15" D Ply 6 Lugs	\$261.99	F0-9338100
505442	(3S096HD) ST235/85R 16" E Ply 8 Lugs	\$387.69	F0-8317200

Steel Directional Wheel



Choose between Silver Rim or Chrome Rim.

BIAS PLY TRAILER TIRE WITH SILVER RIM

Order No.	Mfg. No. / Description	List Price	
506350	(3S967) ST175/80D 13" C Ply 5 Lugs	\$146.99	F0-9820100

BIAS PLY TRAILER TIRE WITH CHROME RIM

Order No.	Mfg. No. / Description	List Price	
506379	(3S465) ST205/75D 14" C Ply 5 Lugs	\$223.09	F0-6165100

RADIAL PLY TRAILER TIRE WITH CHROME RIM

Order No.	Mfg. No. / Description	List Price	
1072928	(32115) ST205/75D 14" C Ply 5 Lugs	\$257.09	HO-5245100

RADIAL PLY TRAILER TIRE WITH SILVER RIM

Order No.	Mfg. No. / Description	List Price	
505168	(31986) ST185/80R 13" C Ply 5 Lugs	\$166.59	F0-1661100
505170	(32194) ST205/75R 14" C Ply 5 Lugs	\$228.59	F0-1006100

Tracker Tire and Wheel Assembly



BIAS PLY TRAILER TIRE

Order No.	Mfg. No. / Description	List Price	
5050270	(3H453) 205/65 10" 6 Ply 5 Lugs	\$129.99	F0-9909000

Painted White Plain Wheel



BIAS PLY TRAILER TIRE

Order No.	Mfg. No. / Description	List Price	
505012	(30000) 480 8" 4 Ply 4 Lugs	\$47.59	F0-1333000
505024	(30020) 480 8" 4 Ply 5 Lugs	\$47.59	F0-1333000
505036	(30080) 570 8" B Ply 4 Lugs	\$67.49	F0-4274000
505048	(30100) 570 8" B Ply 5 Lugs	\$67.49	F0-4274000
506351	(3H390) 205/65 10" C Ply 5 Lugs	\$125.49	F0-4878000
505166	(3H430) 205/65 10" D Ply 5 Lugs	\$149.29	F0-0540100

BIAS PLY TRAILER TIRE - WIDE PROFILE

Order No.	Mfg. No. / Description	List Price	
506353	(3H480) 205/65 10" E Ply 5 Lugs	\$153.89	F0-2770100

Painted White Spoke Wheel with Stripe



BIAS PLY TRAILER TIRE

Order No.	Mfg. No. / Description	List Price	
505062	(30540) 480 12" B Ply 4 Lugs	\$89.49	F0-4626000
505074	(30580) 480 12" B Ply 5 Lugs	\$89.49	F0-4626000
505086	(30700) 530 12" 4 Ply 4 Lugs	\$99.59	F0-1796000
505098	(30740) 530 12" 4 Ply 5 Lugs	\$99.59	F0-1796000
505102	(30820) 530 12" C Ply 5 Lugs	\$107.39	F0-7157000
505125	(3S030) ST175/80D 13" B Ply 4 Lugs	\$134.79	F0-5349000
505137	(3S050) ST175/80D 13" B Ply 5 Lugs	\$134.79	F0-5349000
505149	(3S140) ST175/80D 13" C Ply 5 Lugs	\$137.99	F0-9569000
506354	(3S440) ST205/75D 14" C Ply 5 Lugs	\$170.39	F0-7291100
5050265	(3S640) ST205/75D 15" C Ply 5 Lugs	\$169.29	F0-0581100

RADIAL PLY TRAILER TIRE

Order No.	Mfg. No.	Size	Lugs	List Price	
1072929	(32395)	ST205/75R-15 15"	C Ply 5	\$258.99	F0-0581100

SPECIAL HANDLING MAY APPLY



- Electronics
- Trolling Motors
- Instruments
- Electrical
- Lighting
- Anchor & Dock
- Safety
- Steering, Controls
- Pumps
- Fuel System
- Seating & Pedestals
- Trailer Tires
- Tops & Covers
- Perform.
- Propellers
- Engine & Care
- Cleaning & Care
- Paint & Paint Acc.
- Fun & Flotation
- Topside Acc.
- Cockpit & Deck
- Hardware, Fasteners
- Camouflage
- Misc.
- Comm.

Painted White Mod Wheel with Stripe

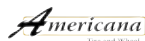

BIAS PLY TRAILER TIRE

Order No.	Mfg. No. / Description	Size	Ply	Lugs	List Price	
5050130	(30582) 480	12"	4 Ply	5 Lugs	\$89.49	FO-4626000
505100	(30831) 530	12"	C Ply	5 Lugs	\$110.39	FO-7277000
506340	(3S052) ST175/80D	13"	B Ply	5 Lugs	\$134.79	FO-5349000
506338	(3S470) ST205/75D	14"	C Ply	5 Lugs	\$170.39	FO-7291100

Steel Rims - ONLY



White Solid Center Rim



White with Stripes Spoke Rim



Galvanized Spoke Rim



GALVANIZED SPOKE RIMS

Order No.	Mfg. No.	Rim Size	Lugs	Capacity	List Price	
506230	(20124) 12 x 4JA		4	1,250 lbs.	\$41.09	FO-6782000
506254	(20224) 13 x 4.5JJ		4	1,660 lbs.	\$52.29	FO-0663000
506266	(20234) 13 x 4.5JJ		5	1,375 lbs.	\$52.29	FO-0663000
506305	(20354) 14 x 6		5	1,870 lbs.	\$65.59	FO-1954000
506329	(20524) 15 x 6JJ		5	2,200 lbs.	\$80.29	FO-0265000

WHITE WITH STRIPES SPOKE RIMS

Order No.	Mfg. No.	Rim Size	Lugs	Capacity	List Price	
506141	(20232) 13 x 4.5JJ		5	1,375 lbs.	\$44.59	FO-1213000

WHITE SOLID CENTER RIMS

Order No.	Mfg. No.	Rim Size	Lugs	Capacity	List Price	
5050080	(20046) 10 x 6		5	1,650 lbs.	\$37.39	FO-7162000

Lug Nuts and Lug Bolts



Sold 5 per card.



7-1855

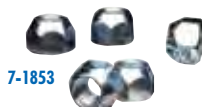

7-1853

LIMITED QUANTITIES

Order No.	Description	List Price	
7-1855	Lug Bolts 1/2"	\$9.99	FO-9960000
7-1853	Lug Nuts 1/2"	\$6.49	FO-4540000

Trailer Tires - ONLY



KENDA LOADSTAR BIAS K371 TIRE

Order No.	Mfg. No.	Size	Ply	Capacity	List Price	
505606	(10002) 4.80/4.00-8		B	590 lbs.	\$34.79	FO-5342000

KENDA LOADSTAR BIAS K353 TIRE

Order No.	Mfg. No.	Size	Ply	Capacity	List Price	
506333	(10010) 570-8		B	715 lbs.	\$55.69	FO-8983000
5050195	(10012) 570-8		C	913 lbs.	\$61.39	FO-7924000
505620	(10060) 480-12		B	781 lbs.	\$55.39	FO-7783000
505632	(10066) 530-12		C	1,045 lbs.	\$70.19	FO-3194000

KENDA LOADSTAR BIAS WIDE K399 TIRE

Order No.	Mfg. No.	Size	Ply	Capacity	List Price	
506349	(1HP52) 205/65-10		C	1,100 lbs.	\$92.59	FO-1846000

KENDA LOADSTAR BIAS K550 TIRE

Order No.	Mfg. No.	Size	Ply	Capacity	List Price	
505656	(1ST76) ST175/80D13		C	1,360 lbs.	\$95.69	FO-8966000
505668	(1ST79) ST185/80D13		D	1,710 lbs.	\$119.49	FO-4638000
506347	(1ST86) ST205/75D14		C	1,760 lbs.	\$122.99	FO-9068000
506595	(1ST90) ST215/75D14		C	1,870 lbs.	\$122.99	FO-9068000
506557	(1ST92) ST205/75D15		C	1,820 lbs.	\$122.99	FO-9068000
505670	(1ST96) ST225/75D15		D	2,540 lbs.	\$158.79	FO-5111100

KENDA KARRIER RADIAL KR03 TIRE

Order No.	Mfg. No.	Size	Ply	Capacity	List Price	
5050040	(10234) ST205/75R14		C	1,925 lbs.	\$169.49	FO-4681100
506608	(10229) ST215/75R14		C	1,870 lbs.	\$181.89	FO-2372100
506634	(10256) ST225/75R15		D	2,540 lbs.	\$181.89	FO-2372100

KENDA KARRIER RADIAL H/D KR17 TIRE

Order No.	Mfg. No.	Size	Ply	Capacity	List Price	
506709	(10316) ST215/65R17		C	1,874 lbs.	\$205.29	FO-0734100

Lug Nuts and Lug Bolts



- Zinc plated.
- 1/2"-20.
- 5 per package.



5765085



5765084

Order No.	Mfg. No. / Description	List Price	
5765084	(81170) Lug Bolts	\$10.39	FO-7270000
5765085	(81172) Lug Nuts	\$7.79	FO-5450000

Hot Shine High Gloss Tire Spray



- Highly water-resistant polymers keep tires looking shiny.
- Gives your tires that black, wet look.
- Fast, easy to use adjustable sprayer.



Order No.	Mfg. No. / Description	List Price	
2522526	(G12024) 24 oz.	\$11.59	FO-1180000

Hot Shine™ Gloss Tire Coating

- Hot Shine's high gloss formula gives your tires a "wet-look" with a dark shine.
- By combining highly water-resistant polymers with antiozonant technology, Hot Shine keeps your tires looking blacker longer while preventing cracking, browning and premature aging.



Order No.	Mfg. No. / Description	List Price	
6270011	(G13815) 15 oz.	\$11.09	FO-6770000



SPECIAL HANDLING MAY APPLY



- Electronics
- Trolling Motors
- Instruments
- Electrical
- Lighting
- Anchor & Dock
- Safety
- Steering, Controls
- Pumps
- Fuel System
- Seating & Pedestals
- Trailer
- Tops & Covers
- Perform.
- Propellers
- Engine & Care
- Cleaning & Care
- Paint & Paint Acc.
- Fun & Flotation
- Topside Acc.
- Cockpit & Deck
- Hardware, Fasteners
- Camouflage
- Misc.
- Comm.

Tire Cover



- UV and mildew resistant 8 oz. haze grey Performance Poly-Guard 100% marine grade polyester.
- Durable shock cord and 1/4" string installed in hem.
- Water repellent and breathable.
- For 13" tires.

Order No. Mfg. No. / Description List Price
7000304 (TC13F-10) **\$40.09** F0-6082000

Trailer Aid Tandem Tire Changing Ramp



- Made of strong polymer plastic.
- Provides 4-1/2" lift.
- Can withstand up to 15,000 pound weight capacity.
- Dimensions: 24.94" L x 6.13" W x 7.13" H.

Order No. Mfg. No. / Description List Price
1830021 (21) **\$63.19** F0-3244000

Wheel Chock with Rope



- Designed to keep your trailer in place and allows you to re-hitch with confidence.
- It fits tires up to 26".
- Constructed of durable, hard plastic with UV inhibitors.
- The included rope makes removing the chock from the wheel safe and easy

Order No. Mfg. No. / Description List Price
357079 (44472) **\$6.29** F0-0440000

Wheel Chock



- Designed to keep your trailer in place and allows you to re-hitch with confidence.
- It fits tires up to 26".
- Constructed of durable, hard plastic with UV inhibitors.

Order No. Mfg. No. / Description List Price
1834412 (44412) **\$5.89** F0-2140000

Black Plastic Fender - "SUV" Single Tire



- Corrosion proof and impact resistant.
- Tie Down's injection molding process assures consistent quality of shape and finish.
- The modular design accommodates 14" and 15" tires and wheels.
- Each kit contains necessary mounting hardware.
- Black.

Order No. Mfg. No. / Description List Price
5765182 (86553) **\$120.19** H0-1127000

White Plastic Fender



- Upgrade your trailer with these high impact polyethylene fenders.
- Plastic fenders are UV protected.
- Designed for normal and low profile tires.
- "No load" capacity and fit 8" to 12" wheels.
- Dimensions: 7-3/4" x 21" x 5".
- White.

Order No. Mfg. No. / Description List Price
657110 (17026) **\$17.59** F0-1321000

Plastic Trailer Fender



- High density polyethylene (HDPE) fenders.
- Injection molded.
- Impact resistant, 300 lbs. capacity.
- Molded-in color is "scratch proof".
- Built-in fender skirt.
- Optional integral step pad.
- Mounting slots.
- Length 43.4".
- Silver.

Order No. Mfg. No. / Description List Price
1840209 (8594) **\$49.99** G1-9423000

Galvanized Metal Fenders



- Heavy duty stamped fenders are made from 16 gauge galvanized steel.
- Fenders can be drilled to fit a variety of mounting options.
- Mounting brackets not included.

Order No.	Mfg. No.	Wheel Size	Dimensions	List Price	
5765178	(86264)	8"	7" x 20" x 6"	\$22.69	F0-8851000
5765179	(86265)	12"	7" x 23.5" x 6.5"	\$24.99	F0-9471000
5765180	(86266)	13"	8" x 27.5" x 11"	\$33.69	F0-8532000
5765181	(86267)	14-15"	9" x 31.5" x 13"	\$40.49	F0-4382000

Step Bracket for Large Plastic Fenders

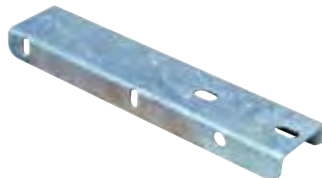

- Galvanized.
- Step bracket for large plastic fenders.
- Dimensions: 13.219" x 4.812" x 1.188".
- Sold each (1 per package).

Order No. Mfg. No. / Description List Price
657115 (44141) **\$14.19** F0-3990000

Easy Lift Jack



- All aluminum construction, polished and sand-shot.
- Lifts and holds boat and camper trailers and other single axle vehicles with wheels from 8"-16".
- 2 tons.
- Dimensions: 9-3/4" W x 4-1/2" H.

Order No. Description List Price
7-1611 Easy Lift Jack **\$28.99** G0-2491000

SPECIAL HANDLING MAY APPLY

- Electronics
- Trolling Motors
- Instruments
- Electrical
- Lighting
- Anchor & Dock
- Safety
- Steering, Controls
- Pumps
- Fuel System
- Seating & Pedestals
- Trailer
- Tops & Covers
- Perform.
- Propellers
- Engine & Care
- Cleaning & Care
- Paint & Paint Acc.
- Fun & Flotation
- Topside Acc.
- Cockpit & Deck
- Hardware, Fasteners
- Camouflage
- Misc.
- Comm.



Spare Tire Carrier



- Heavy duty steel construction, hot dipped galvanized for long lasting protection.
- Fits most 4 and 5 lug tires.
- Attaches to any trailer frame 3" wide x 4" high.
- Easy to install.
- Zinc plated mounting hardware included.

Order No.	Description	List Price	
7-1755	Spare Tire Carrier	\$26.29	F0-0481000

Spare Hub and Tire Carrier



- Heavy duty zinc plated steel carrier mounts both spare hub and spare tire.
- Includes 5 stud pre-greased hub with bearings.
- Designed for 1,750# hub with 1-1/16" and 1-3/8" bearings.
- Fits all trailer frames up to 3" wide and 4" high.

Order No.	Mfg. No. / Description	List Price	
578281	(86079)	\$157.79	F0-5401100

Spare Tire Carrier



- Hot dip galvanized heavy duty welded steel construction.
- Adjustable to fit 4, 5 and 6 lug wheels.
- Fits all trailer frames up to 8" high.
- Carriage bolts and lug nuts to mount tire to carrier are included.

Order No.	Mfg. No. / Description	List Price	
578283	(86069)	\$88.69	F0-8026000

High Mount Spare Tire Carrier



- Hot dip galvanized heavy duty steel tubing.
- Accommodates 4, 5 and 6 lug wheels.
- Fits all trailer frames up to 3" wide by 4" high.
- Carriage bolts and lug nuts to mount tire to carrier are included.

Order No.	Mfg. No. / Description	List Price	
578293	(86101)	\$66.79	F0-5764000

Side Mount Spare Tire Carrier



- Hot dip galvanized extra heavy duty welded steel construction.
- Adjustable bolt circle fits both 4 lug and 5 lug wheels.
- Fits all trailer tongues up to 3" wide by 4" high.
- Carriage bolts and lug nuts to mount tire to carrier are included.

Order No.	Mfg. No. / Description	List Price	
578306	(86098)	\$44.39	F0-7013000

Spare Tire Bracket - Extra Offset



- Heavy duty steel construction.
- Zinc plated Tuffplate finish.
- Fits wheel sizes from 13" to 15", 5 or 6-hole rims, and trailer tongues 2" to 3" wide and 3" to 5" tall.
- Extends spare tire at an angle to avoid damage or marring of boat finish.
- Features locking hole to lock wheel and bracket to the trailer.
- Includes mounting hardware.

Order No.	Mfg. No. / Description	List Price	
388492	(22145)	\$61.99	F0-9334000

NEW PRODUCT

Heavy Duty Spare Tire Carrier



- Heavy duty tire carrier holds top mounting lug hole of tire 10-1/2" out and 4" up from top of the trailer frame or tongue with an additional 25° angle offset.
- Perfect for bow clearance on wide deep V boats.
- Holds spare tire firmly with stud-bolts and nuts.
- Fits 3", 4" and 5" frames and 4 or 5 hole rims.
- Has lock-tab and bar for optional padlock. (Padlock not included)
- Holds 14" to 16" tires at an angle.

Order No.	Mfg. No. / Description	List Price	
3750097	(SM-97)	\$95.09	F0-6566000

Heavy Duty Locking Spare Tire Carrier



- Zinc plated finish.
- Heavy duty tire carrier holds top mounting lug hole of tire 7" out and 6-1/2" up from top of the trailer frame or tongue at a 90° angle to the ground.
- Fits 4 or 5 hole (6 hole with 4-1/2" diameter bolt hole pattern) rims with center hub holes that are 3-1/4" diameter or bigger and (6 hole with 5-1/2" diameter bolt hole pattern) rims with center hub holes that are 4" diameter or bigger.
- Fits 3", 4" and 5" high frames up to 3" wide.
- Has lock-tab and bar for optional padlock. (Padlock not included)
- The rigid tire mount is constructed with extra support brace which fits tires up to 16".

Order No.	Mfg. No. / Description	List Price	
3750098	(SM-98)	\$95.09	F0-6566000

U-Bolt Style Spare Tire Carriers



- Galvanized.
- Fits 4 and 5 hole rims. For 8" through 14" and most 15" wheels.
- Heavy 7/16" u-bolt secures tire on tongue or frame up to 3" wide.
- Adjustable threaded brackets holds padlock for extra security.

Order No.	Description	List Price	
7-59100	With PadLock	\$30.49	F0-4312000
7-59103	With Brackets for PadLock	\$13.59	F0-1590000
7-59104	With (2) Mounting Nuts, No Lock	\$8.49	F0-4950000

U-Bolt Style Tire Carrier



- Zinc plated steel.
- Square bend U-bolt with bracket.
- Mounts tire on tongue or trailer frame.
- Fits 4 or 5 lug hole rims.
- The frame must be between 2" x 2" square to 3-1/2" x 4" rectangular in size.
- Extra long 8-1/2" shaft fits 8" to 15" tires.
- **Note:** Does not include padlock.

Order No.	Mfg. No. / Description	List Price	
333613	(11090-3)	\$10.89	F0-2670000

- Electronics
- Trolling Motors
- Instruments
- Electrical
- Lighting
- Anchor & Dock
- Safety
- Steering, Controls
- Pumps
- Fuel System
- Seating & Pedestals
- Trailering
- Tops & Covers
- Perform.
- Propellers
- Engine & Care
- Cleaning & Care
- Paint & Paint Acc.
- Fun & Flotation
- Topside Acc.
- Cockpit & Deck
- Hardware, Fasteners
- Camouflage
- Misc.
- Comm.

U-Bolt Style Trailer Spare Tire Bracket



- Zinc plated Tuffplate finish.
- Extra length allows for handling of wide tires or spans the wider tongues of custom built trailers.
- Fits 8", 9" or 12" wheels and 4 or 5-hole rims.
- Includes mounting nuts and lock bracket.

Order No. **333625** Mfg. No. / Description (22140) List Price **\$31.89** FO-2322000

U-Bolt Style Trailer Spare Tire Bracket



- Zinc plated Tuffplate finish.
- Extra length allows for handling of wide tires or spans the wider tongues of custom built trailers.
- Fits 8", 9" or 12" wheels and 4 or 5-hole rims.
- Includes mounting nuts.

Order No. **7000392** Mfg. No. / Description (22128) List Price **\$19.09** FO-6331000

Trailering Clips



Order No. **189096** Mfg. No. / Description (18-9096) Fits: Volvo SX-A, DPS-A (2007-Up) List Price **\$39.49** ZO-9632000
 Order No. **189098** Mfg. No. / Description (18-9098) Fits: All SX Models thru 2006 List Price **\$32.49** ZO-5491000
 Order No. **189099** Mfg. No. / Description (18-9099) Fits: All ALPHA 1, ALPHA GEN II, BRAVO List Price **\$42.09** ZO-5252000

Stabilizer Clips



Order No. **841070** Mfg. No. / Description (HYCL-001-1) List Price **\$18.09** FO-6621000

- 4" long stabilizer clips for Dometic steering cylinders.
- Sold 2 per pack.

Outboard Locking Systems



- Marine grade stainless steel with high impact nylon endcaps.
- The Motomate Locking System prevents costly damage to your steering system and excess torque on your transom.
- Releases pressure off your hydraulic system.
- **Please Note:** Please measure the lower unit of your motor before purchase.

NEW MODELS

FOR JOHNSON/EVINRUDE OUTBOARDS

Order No.	Mfg. No.	Application	Yoke	Transom	Color	List Price	
209214	(10-101-SSB)	85-250 HP (2-Stroke) 1991-10; 90-150 HP E-Tech; 90-250 HP HO	4-1/2"	6-1/4"	Black	\$147.29	FO-0130100
209216	(10-101-SSR)	85-250 HP (2-Stroke) 1991-10	4-1/2"	6-1/4"	Red	\$147.29	FO-0130100
209218	(10-102-SSB)	E-Tec G2 Models: 225-300 HP; 200-250 HP HO	N/A	N/A	Black	\$181.19	FO-3862100

FOR MERCURY OUTBOARDS

Order No.	Mfg. No.	Application	Yoke	Transom	Color	List Price	
209200	(10-201-SSB)	75-115 HP (2-Stroke)	3-7/16"	7-7/16"	Black	\$147.29	FO-0130100
209202	(10-201-SSR)	75-115 HP (2-Stroke)	3-7/16"	7-7/16"	Red	\$147.29	FO-0130100
209204	(10-202-SSB)	ProXS 125-175 HP (2-Stroke); 150-200 HP EFI; 200 HP Carbureted	3-1/8"	7-7/16"	Black	\$147.29	FO-0130100
209206	(10-202-SSR)	ProXS 125-175 HP (2-Stroke); 150-200 HP EFI; 200 HP Carbureted	3-1/8"	7-7/16"	Red	\$147.29	FO-0130100
209208	(10-203-SSB)	225-300 HP (2-Stroke); 225-250 HP EFI; 200-250 HP ProXS	4-9/16"	7-7/16"	Black	\$147.29	FO-0130100
209210	(10-203-SSV)	225-300 HP (2-Stroke); 225-250 HP EFI; 200-250 HP ProXS	4-9/16"	7-7/16"	Yellow	\$147.29	FO-0130100
209212	(10-203-SSR)	225-300 HP (2-Stroke); 225-250 HP EFI; 200-250 HP ProXS	4-9/16"	7-7/16"	Red	\$147.29	FO-0130100
209194	(10-225-SSB)	75-115 & 175-300 HP (4-Stroke) Sea Pro & ProXS	N/A	7-7/16"	Black	\$181.29	FO-0962100
209196	(10-225-SSR)	75-115 & 175-300 HP (4-Stroke) Sea Pro & ProXS	N/A	7-7/16"	Red	\$181.29	FO-0962100
209198	(10-225-SSN)	75-115 & 175-300 HP (4-Stroke) Sea Pro & ProXS	N/A	7-7/16"	Natural	\$181.29	FO-0962100

FOR YAMAHA OUTBOARDS

Order No.	Mfg. No.	Application	Yoke	Transom	Color	List Price	
209220	(10-300-SSB)	115-175 HP (4-Stroke) Through 2014	4-3/4"	8-1/4"	Black	\$191.29	FO-0933100
212162	(10-301-SSB)	115-175 HP (2-Stroke)	3-3/4"	8-1/4"	Black	\$181.29	FO-0962100
209222	(10-302-SSB)	200-250 HP (2-Stroke) Excluding 2000-04	6"	8-1/4"	Black	\$191.29	FO-0933100
209224	(10-303-SSB)	200-250 HP (4-Stroke) SHO Models	5-7/8"	7-3/4"	Black	\$181.29	FO-0962100
209226	(10-303-SSV)	200-250 HP (4-Stroke) SHO Models	5-7/8"	7-3/4"	Yellow	\$181.29	FO-0962100
209228	(10-303-SSR)	200-250 HP (4-Stroke) SHO Models	5-7/8"	7-3/4"	Red	\$181.29	FO-0962100
212124	(10-303B-SSB)	115 HP (4-Stroke) SHO Models	4-3/4"	7-3/4"	Black	\$191.39	FO-7933100
209230	(10-303A-SSB)	150 HP (4-Stroke) SHO Models	4-3/4"	7-3/4"	Black	\$181.29	FO-0962100

FOR HONDA OUTBOARDS

Order No.	Mfg. No.	Application	Yoke	Transom	Color	List Price	
212251	(10-401-SSB)	90-150 HP (4-Stroke)	3-1/4"	7-3/16"	Black	\$147.09	FO-6920100

- Electronics
- Trolling Motors
- Instruments
- Electrical
- Lighting
- Anchor & Dock
- Safety
- Steering, Controls
- Pumps
- Fuel System
- Seating & Pedestals
- Trailering
- Tops & Covers
- Perform.
- Propellers
- Engine & Care
- Cleaning & Care
- Paint & Paint Acc.
- Fun & Flotation
- Topside Acc.
- Cockpit & Deck
- Hardware, Fasteners
- Camouflage
- Misc.
- Comm.

Outboard Motor Lock



- Locks most outboard motors up to 40 HP.
- Hardened steel locking bar.
- EVA foam lined to eliminate rattle.
- Includes marine grade brass pad lock that fits inside bar.

Order No. Description List Price
7-52612 Outboard Motor Lock **\$27.99** FO-9591000

Outboard Lock



- Made of heavy duty carbon steel tubing and fits turnbuckle-mounted engines.
- The vinyl-clad steel tube slides easily over the motor lock downs and is secured with a hardened brass padlock.
- Noise dampeners reduce the rattle.
- The padlock is recessed to deter cutting.
- Comes with two keys.

Order No. Mfg. No. / Description List Price
1948000 (758000) **\$35.99** HO-9512000

4" Steer Stop Outboard Hydraulic Steering Lock



- Locks hydraulic steering when trailering.
- Fits most steering cylinder rods on outboard engines.
- Snaps over outboards hydraulic steering cylinder rods.
- Helps keep engine centered during transport.
- Protects steering system, outboard, and motor supports.
- Includes cord to connect units for storage and to aid in removal.

Order No. Mfg. No. / Description List Price
640945 (SS-3-DP) **\$22.89** EO-7171000

Engine/Trim Ram Mounted Transom Saver



- Quickly installs over the outboard trim ram.
- Minimizes the strain on the trim/tilt system.
- Relieves stress on the boats transom.
- Compatible with: Yamaha, Mercury, Evinrude/Johnson, Suzuki and Honda outboards.
- Prevents the outboard from slipping back into a vertical position.
- Sold each.

Order No. Description List Price
7-59127 Engine/Trim Ram Mounted Transom Saver **\$26.89** FO-2881000

Lock N' Stow™



- Locks the outboard motor in the forward position while trailering, greatly reducing the damaging effects of road shock.
- Does not "tie" engine's lower-unit to trailer, eliminating excessive pressure on hydraulic seals and scuff marks.
- Small compact mount can be easily stored in just about any boat compartment.
- Constructed of black powder-coated steel with stainless steel pins.

FITS: MERCURY ENGINES

- Fits: 200 OptiMax, 255 OptiMax, 225 HP EFI, 250 HP EFI.

Order No. Mfg. No. / Description List Price
587562 (10107) **\$140.19** FO-3189000

- Fits: 135 OptiMax, 150 OptiMax, 175 OptiMax, 75 HP - 200 HP EFI.

Order No. Mfg. No. / Description List Price
587564 (10108) **\$131.49** FO-4029000

FITS: OMC ENGINES

- Fits: OMC, Bombardier 1989 to present, 100 HP and up.

Order No. Mfg. No. / Description List Price
5870013 (10309) **\$130.09** FO-6019000

LIMITED QUANTITIES

Extend-A-Reach Motor Support



- Heavy duty steel with corrosion resistant E-coat finish.
- Secures the motor to trailer crossbar.
- Removes easily for quick loading and unloading.
- Includes 15" black EPDM rubber holding strap.
- Adjusts from 26" to 56".

Order No. Mfg. No. / Description List Price
552302 (1780250) **\$109.49** FO-4667000

Motor Stik™ Outboard Motor Support



- Fits over Trim Rams.
- Supports your outboard while trailering.
- Helps prevent hydraulic steering system damage.
- Most outboards 150 HP and up.
- Strong aluminum tubing with molded ends.
- Safe for salt or fresh water.

Order No. Mfg. No. / Description List Price
640664 (MSS-1-DP) **\$52.59** EO-4493000

Motor Support Bracket



Over-the-Roller Mount

7-0387

- Lightweight powder coated corrosion resistant head and mounts are lightweight, durable and corrosion resistant.
- Bolt-on or over-the-roller universal mount. Indestructible polypropylene pads.
- Easy-to-handle lightweight aluminum tubing will not rust.
- EPDM rubber strap with stainless steel hooks.
- Stainless steel hardware and fasteners eliminate corrosion.
- Coupler safety pin included for easy adjustment.

Order No. Description List Price
7-0386 Adjustable from 21" - 31" **\$60.69** GO-6604000
7-7386 Adjustable from 24" - 36" **\$61.59** GO-7214000
7-7388 Adjustable from 36" - 48" **\$64.99** GO-4534000
7-0387 Spare Bracket Kit **\$17.39** FO-7121000

- Electronics
- Trolling Motors
- Instruments
- Electrical
- Lighting
- Anchor & Dock
- Safety
- Steering, Controls
- Pumps
- Fuel System
- Seating & Pedestals
- Trailering
- Tops & Covers
- Perform.
- Propellers
- Engine & Care
- Cleaning & Care
- Paint & Paint Acc.
- Fun & Flotation
- Topside Acc.
- Cockpit & Deck
- Hardware, Fasteners
- Camouflage
- Misc.
- Comm.

Heavy Duty Transom Savers - Adjustable

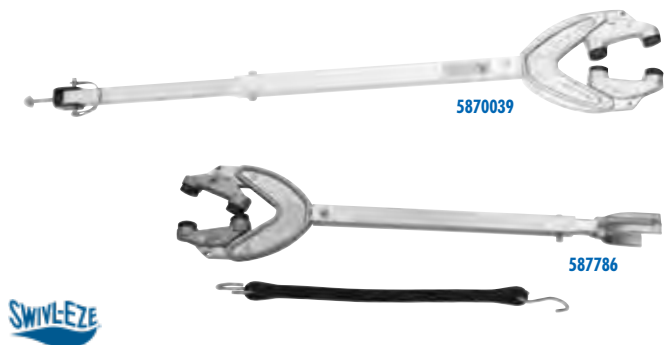

- Support the cantilevered weight of the motor.
- Stabilize engine and steering mechanism when trailering.
- Our shock absorbing spring-loaded transom saver, is designed to reduce damaging effects of road shock.
- Works great for motors with hydraulic trim/tilt.
- Head type: Heavy duty.

Order No.	Mfg. No.	Mounting Bracket	Adjusts from	List Price	
587786	(4000-ADJ)	Roller	24" - 36"	\$69.19	F0-3484000
5870039	(4000-ADJ-B)	Trailer Mount	24" - 36"	\$69.79	F0-5884000
587787	(SP-4000-ADJ-RB)	Roller/Trailer Mount	24" - 36"	\$81.39	F0-7965000
587709	(424-ADJ)	Roller	32" - 44"	\$79.99	F0-9955000
587760	(436-ADJ)	Roller	44" - 56"	\$86.69	F0-8606000
1024024	(SP-436-ADJ-RB)	Roller/Trailer Mount	44" - 56"	\$93.49	F0-4456000

REPLACEMENT PARTS

Order No.	Mfg. No. / Description	List Price	
5870076	(SP-402) Bolt On Bracket	\$28.39	F0-7891000
5870077	(SP-410) Rubber Shocks for Heavy Duty Head	\$12.39	F0-7680000
587710	(SP-416) Toggle for Heavy Duty Head	\$14.59	F0-1201000

Tourney Motor Support



- Constructed with high-strength anodized aluminum.
- Adjustable from 25" to 35".
- Includes bolt-on and over-the-roller brackets.

Order No.	Mfg. No. / Description	List Price	
2187218	(FXK)	\$92.99	H0-9755000

LIMITED QUANTITIES

Adjustable Transom Saver



- Corrosion resistant black finish.
- Unique angle adjustments (patent pending) from 0° to 36° in 12° increments.
- Heavy duty rubber pads prevent scratching on the lower unit.
- Head type: Heavy duty.
- Mounting bracket: Trailer mount.
- Adjusts from 36" to 60".

Order No.	Mfg. No. / Description	List Price	
512030	(460-ADJ)	\$175.59	F0-1922100

Adjustable Transom Savers



- Support the cantilevered weight of the motor.
- Stabilize engine and steering mechanism when trailering.
- Head type: Composite.
- Adjusts from 23" - 35".

Order No.	Mfg. No.	Mounting Bracket	List Price	
587708	(SP-400-RB)	Roller/Trailer Mount	\$61.49	F0-4034000
1144070	(400-B)	Trailer Mount	\$59.39	F0-7514000
1144071	(400-R)	Roller	\$62.09	F0-6434000

Tourney Pro Motor Support



- Constructed with high-strength anodized aluminum.
- Adjustable from 24" to 36".
- Includes bolt-on and over-the-roller brackets.

Order No.	Mfg. No. / Description	List Price	
2187217	(FXJ)	\$88.09	H0-5825000

LIMITED QUANTITIES

Adjustable Transom Saver



- This Transom Saver adjusts from 28" to 59" to reach hard-to-access trailer crossbars that extend under the boat.
- Comes with an easy-to-install bracket attachment.
- Fits most popular brands of trailers and is easily removed for loading and unloading.

Order No.	Mfg. No. / Description	List Price	
1941900	(551900)	\$70.09	F0-6094000
1945580	(9955805) Replaceable Rubber V-Block	\$12.09	F0-6480000