

Continental 
The Future in Motion



Power Transmission Products

2015 Full Line Catalog

www.contitech.us

ContiTech

The 3 E's of Efficiency

At Continental ContiTech, we are committed to helping you improve your bottom line. That is why we provide a team of drive system specialists, a wide range of products and maintenance tools to help ensure your mechanical belt drive systems run as efficiently as possible. Three simple steps can help you save energy, increase productivity and keep your systems operating at their best:



Evaluate

Competence for facility-wide improvement.

As an industry-leading manufacturer of Continental ContiTech's branded synchronous and V-configured power transmission belts, we will help you enhance productivity and operational savings, reduce noise and lower energy costs.



Empower

Recommendations that deliver value.

With a large selection of industry-leading drive components, we will help you reduce energy consumption and maximize efficiencies.



Educate

Hands-on training to ensure longevity.

Our Continental ContiTech Technical Managers offer a full training curriculum, providing you access to the latest in installation and maintenance best practices.

See how the 3 E's have enhanced efficiencies for operations like yours at realtpresults.com.

Table of Contents

Overview

Power Transmission Products	3-4
MaximizerPro™	5
Drive Change™ Tools	6-7

Synchronous Belt Products

Introduction to Synchronous Belts	8
SilentSync®	8M, 14M 9-12
SilentSync® Sprockets	8M, 14M 13-19
Falcon Pd®	8M, 14M 20-21
Falcon Pd® Sprockets	8M, 14M 22-24
Hawk Pd®	3M, 5M, 8M, 14M, 20M 25-26
Hawk Pd® Sprockets	3M, 5M, 8M, 14M, 20M 27-30
Hawk Pd® Taper-Lock Sprockets	8M, 14M 31-32
Blackhawk Pd®	8M, 14M 33-34
Blackhawk Pd® Sprockets	3M, 5M, 8M, 14M, 20M 35-36
Positive Drive Pd®	MXL, XL, L, H, XH, XXH 37-39
Positive Drive Pd® Sprockets	XL, L, H, XH, XXH; L & H Taper-Lock 40-45
Super Torque Pd®	S3M, S4.5M, S5M, S8M, S14M 46-48
Dual Hi-Performance Pd®	8M, 14M 49-50
Dual Positive Drive	XL, L, H 51
Open End Pd®	Positive Drive Pd®, Falcon Pd®, Hawk Pd®, Super Torque Pd®, Metric T Pd® 52-54
Polyurethane Belts	T, AT, ATL, HTD®, RTD, STD, TK, ATK, XL, L, H, XH, Flat belting 55-58
Acculinear®	59-61
Acculinear® Sprockets	59-63
Acculinear® Clamping Plates	64

Banded Belt Products*

Introduction to Banded Belts	65
Torque Team® (Laminated)	5VL 66
HY-T® Wedge Torque Team®	3VX, 3V, 5VX, 5V, 8V 67-69
Torque Team Plus®	5VF, 8VF 70-73
Poly-V®	H, J, K, L, M 74-76

V-Belt Products

Introduction to V-Belts	77-78
Wedge TLP™ Narrow	3VT, 5VT, 8VT 79-80
HY-T® Wedge	3VX, 3V, 5VX, 5V, 8VX, 8V 81-83
HY-T® Plus (Classical)	A, B, C, D, E 84-87
Torque-Flex®	AX, BX, CX 88-91
Metric	XPZ, XPA/SPA, XPB/SPB, XPC/SPL 92-95
Hex	AA, BB, CC, CCP 96-98
Insta-Power® (Aramid Classical)	83, 84, 85, 87 99-101
FHP	2L, 3L, 4L, 5L 102-104
Open End V-Belting	A, B, C, D 105
Metal Sheaves and Pulleys	106-122

Bushing/Flat Idlers Hardware

Bushings	123-135
Flat Idlers	136-137

Specialty Belt Products

Neothane®	3M, 5M, 7M, 11M 138-140
Variable Speed	141-143
Flat Belting (Truly Endless)	144-146
Bowling Machines	147
Axial Fan Pd® Belts	14M 148
Axial Fan Pd® Sprockets	14M 149
Cotton Cleaners	61CCB, 63CCB, 64CCB, 65CCB 149

Continental Elite Automotive & Truck Belt Products

Poly-V® Belts	150
V-Belts	150
Timing Belts	151
Truck Refrigeration Belts	151

General Information

Belt Size Information	152
Technical Information	153-163
Mandrel Quantity Requirements	164-166
Belt Storage	166-168
Matchmaker® System	169
Oil & Chemical Resistance of Power Transmission Belts	170
Static Conductive Belts	171
Product Accessories & Sales Aids	172-174
Terms & Conditions	175
Warnings	176

Notice on Static Conductivity

Drive conditions and service variables in combination with time in operation can result in loss of static conductivity. It is recommended that a conductivity check be added to drive preventative maintenance programs where belt static conductivity is a requirement. For more information on static conductivity, see page 171 in back of catalog.

We Provide Much More than Quality Products

Working with us, you will receive the high level of service and support that is critical to stay ahead in today's business environment. Our branded power transmission products are available through qualified distributors that are carefully selected and trained to provide much more than quality Continental ContiTech products. A complete selection of value-added services are available including cost reduction programs, sales and technical support and inventory control programs.



SilentSync®

Innovative Products

Continental ContiTech is an industry leader with an enviable history of product innovation and power transmission industry firsts, including:

- › **Falcon Pd®** synchronous belts are setting the new standard in synchronous belt drive systems.
- › **SilentSync®** enhanced premium synchronous belts, with a patented Helical Offset Tooth (H.O.T.) design for reduced noise, reduced vibration and increased efficiency have increased horsepower and temperature ratings designed to perform.
- › **MaximizerPro™** Drive Selection Analysis software program for easy, accurate selection of the best money-saving components for your application.
- › **Wedge TLP™** provides an advanced homogeneous construction, allowing unprecedented performance that requires virtually no maintenance.
- › **Torque Team Plus®** belts with the strength and power transmission capacity to replace large chain drives.
- › **Poly-V®** belts with nylon fabric rib facing, fiber-loaded rib compounds and fully machined rib surfaces.



Falcon Pd®

Equally important, the research and development that produced these dramatic improvements is a continuing process. We continue to have a multitude of new innovations that are being developed at our Research and Development Center in Lincoln, Nebraska.

That means our branded Power Transmission Products will continue to meet the increasing demands for improved drive efficiency, long belt life and competitive costs.



Distribution you can count on

Our distributors are committed to providing you the absolute best in products and service. They are thoroughly trained on Continental ContiTech belting and stand ready to meet all your power transmission needs.

These distributors are backed by a staff of sales representatives specially trained and qualified to conduct in-depth studies of your current operations. In addition, sales representatives and our distributors have access to powerful computer programs needed to optimize your current drive/belt applications.

Take comfort in the high level of service, delivery and technical expertise that only comes from a local source backed by a manufacturer with advanced worldwide research and production capabilities.

Cost reduction programs

We can provide you with the tools and services to reduce your operating costs associated with power transmission products. Through training and drive analysis software, we can show you how to eliminate problem drives that are bringing down your productivity.

Customized training

Whenever you need it, wherever you want it, customized training is available for your associates. From maintenance and installation clinics to in-depth training on analyzing failed power transmission products, our distributors and sales representatives can give you the guidance needed to choose, install and maintain your power transmission products.

Installation, maintenance and troubleshooting tools

From initial installation to routine maintenance checks, we offer the tools that make your job easier. Simple to use, reliable and more important, keeping your operations productive and efficient.

Technical assistance

We are proud to offer you the very finest "problem solvers" in the industry. All our distributors are factory-trained in the applications of the products we manufacture. Our professional design engineers are also available for consultation by calling your sales representative. Their combined knowledge and experience are there for you around the clock.

Customer satisfaction

Customer satisfaction is foremost in our guiding principles. It shows in our services. It shows in our products. Most importantly, it shows in the unparalleled customer quality rating our branded power transmission products have received from several key OEMs.

We have determined that the surest route to customer satisfaction is through a constant effort to improve. This commitment guarantees the quality of Continental ContiTech products, our services, deliveries and more – both now and in the years to come.

ISO 9001 certified global sourcing

With state-of-the-art manufacturing facilities around the world, we have the capability of meeting market demands by strategically sourcing product to fill the product supply pipeline. You can also count on the same quality product no matter where in the world our products originate.

ISO 9001 is one of the most widely accepted international standards for quality. Our belt manufacturing plants are all ISO 9001 certified.

Quality service

Our pledge is a simple one: Quality service that you can always depend on. It is a commitment from us and our distributors to you.

DRIVE CHANGESM

MAXIMIZING YOUR EFFICIENCY

With Continental ContiTech, you are much more than a customer. You are an integral piece to success. We pledge to support you with quality products, inventory, service, technical help and more.

Continental ContiTech has a tradition of product excellence. Along with our extensive distributor network, Continental ContiTech forms a team second to none in total product and service offerings. Our goal is to supply you with the best products.

We are constantly looking for ways to help you save money on your existing processes, combining your expertise with our knowledge of power transmission products to make every operation as efficient as possible.

Drive ChangeSM is a program we promote to maximize efficiencies, reduce maintenance costs and increase your productivity. We know that it only takes minor improvements in drive efficiency to improve your facility's efficiency with each energy dollar spent. To pinpoint the improvements, we have developed easy-to-use software programs such as MaximizerProTM. With MaximizerProTM, mechanical drive costs can be analyzed, thus identifying the best drive belts for your needs.

In many instances, Drive ChangeSM involves upgrading your drives to the latest innovative belt technology that allows for increased efficiency and reduced cost of operation. For example, upgrading from a standard Classical V-belt to a Narrow V-belt can reduce hardware and maintenance costs while increasing horsepower and load-carrying capabilities. To take it a step further, V-belts could be replaced altogether with a premium synchronous belt like SilentSync[®] or Falcon Pd[®], permitting less maintenance and more efficiency.

MaximizerPro™

Allowing the user to have Continental ContiTech belt specifications and information right at their fingertips

This exciting program is now available in three ways: desktop and web-enabled or a convenient mobile app for popular devices. It makes drive recommendations a snap. With MaximizerPro™ drive requirements specified by the user are matched with available belts, sprockets, pulleys and bushings. Working like an equation for improved performance, MaximizerPro™ takes specific physical data and calculates how the system can be upgraded with multiple options for belt drive designs. These options address the end-user's goals related to energy efficiency, quieter operation, increased output and extended life, to name a few.



The data collection form

Allows you to gather all of the drive specifications required to run the selection program. Specifications include:

- > Drive operation time
- > Horsepower load
- > DriveR and DriveN rpms
- > Center distance
- > Service factor
- > Energy cost



The maximization screen

Provides an easy way to view, sort and print the resulting selections. From the maximization screen, drive selections can be sorted by:

- > Face width
- > Noise level
- > Energy cost
- > Service factor
- > Belt speed
- > Drive cost index
- > Energy payback feature
- > "Where to Buy" - Distributor locator

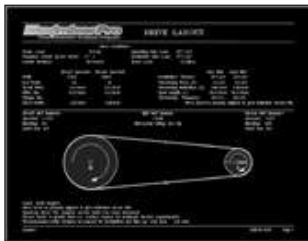

The drive design printouts

Provides printable pertinent information for the selected drive. Information available from the detail screen includes:

- > Belt, sprocket and bushing part numbers
- > Engineered drawings on all drive part numbers (where applicable)
- > Drive layout
- > Installation and maintenance tensioning



MaximizerPro™ is available by visiting our website at www.contitech.us/maxpro.

Download mobile App

Power Up the Value

Drive ChangeSM Program

Get the perfect mix of technology, tools and training designed to increase value with each purchase of power transmission products.

With Continental ContiTech and our distributors, we offer an exclusive, all-encompassing Drive ChangeSM program that optimizes the life and performance of your belt drives. Drive ChangeSM is our way of ensuring you are up-to-date on required installation and maintenance tools and procedures necessary to maximize plant operations and optimize output where belt drives are used to transfer power. Schedule an in-plant seminar with your sales representative and dedicated distributor. The next step is yours.



Laser Alignment Tool

Fast, convenient and attaches in a few seconds, delivering a highly visible sight line.

When the laser line lies within the target openings, the pulleys/sprockets are correctly positioned. The result is a fast and precise alignment. Power transmission belts including synchronous, V-belts, flatbelts and more can be aligned equally well. The smart design of the magnetic attachment surface also allows for alignment of both small and large sheaves. For nonmagnetic pulleys, double-sided tape can be used to affix the tool for an added range of applications.



Key features & benefits

- › Mobile version for popular mobile phones and tablets
- › Detects both radial and axial misalignment
- › Easier to use than conventional methods of misalignment detection
- › Affixes to most pulley and sprocket types
- › Also suitable for nonmagnetic pulleys and sprockets
- › Single operator friendly

TensionRite[®] Belt Frequency Meter

Provides a simple, repeatable and reliable method for tensioning belts using optical technology.

TensionRite[®] Belt Frequency Meter displays the natural vibration frequency of a belt so you can closely monitor belt tension. The device calculates the corresponding belt tension in either English or SI units.

Key features & benefits

- › Light optics-based tensioning
- › Quartz crystal-based solid-state circuitry
- › Direct vs. indirect measurement of vibration frequency
- › Meter range matches "real-life" belt installation parameters
- › Can be used with all belt types



Power Up the Value

MaximizerPro™ Drive Selection Analysis Program

Maximize your energy savings.

MaximizerPro™ is the newest and most powerful version of our exclusive drive system analysis software. Still as simple and intuitive to use as ever, MaximizerPro™ has all the features you have come to know, plus some new, powerful upgrades. Data entered into the software is cross-checked against MaximizerPro™'s robust database of available belts, sprockets, pulleys and bushings. The resulting customized report outlines specific products that can help you reach maximum efficiency and energy savings. MaximizerPro™ can enhance your drive systems the first time and every time.



Key features & benefits

- › Mobile version for popular mobile phones and tablets
- › New online version is always up-to-date
- › "Preferred solutions" option for most efficient drive designs
- › Improved screen layouts for quicker navigation
- › Energy consumption displays for specific drives
- › More comprehensive tensioning parameters

Large Tension Tester

When used with a straight edge or tight string, can be an aid in setting the proper belt tension for a drive system.

The relationship between deflection and belt span has been incorporated in the index scale printed on the face of the gauge. This eliminates one calculation associated with the tensioning operation.

Key features & benefits

- › Quickly helps determine belt tension
- › Compares force measured with recommended values for your application
- › If values are not equal, simply adjust the belt tension and repeat force measurement until measured force matches target value

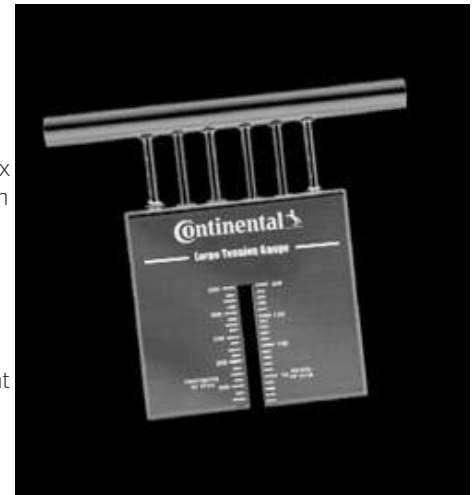

Synchronous Belts

Continental ContiTech synchronous drive products

Synchronous or Positive Drive (Pd®) belts are a relatively new concept in power transmission belting evolution. These belts combine the advantages of chain and gear with the advantages of V-belts, but without the limitations usually associated with these conventional types of drives. There is minimal elongation, no metal-to-metal contact and no constant lubrication. Synchronous belts are amazingly versatile with possible applications on drives up to 600 horsepower and from speeds under 100 feet per minute to over 6,000 feet per minute.

Pd® is the term applied to our synchronous belts and their method of power transmission. As the name indicates, Pd® belts make possible power transmission that is efficient and accurate to a precise degree.

Pd® belts also make possible important savings in weight, space and construction without the sacrifice of efficiency. They are adaptable to almost any type of power transmission drive from printers to heavy industrial milling machines and grinders.

Engineered and manufactured with extreme care with pitch, tooth depth, width and other measurements accurate to a precise degree, Pd® belts are highly engineered products. The materials used in these remarkable belts consist of high-strength tension members, specially compounded rubber and proven synthetic fabrics. The belts are designed to eliminate excessive heat build-up and operate efficiently.

The evolution of the Pd® belt line

Continental ContiTech manufactures several different designs available as open end constructions and in dual-sided constructions.

Positive Drive Pd® is our trademark line of trapezoidal tooth profile synchronous belts. These belts were the first profile types developed in the continual evolution of synchronous drive belts. This Positive Drive product line includes a stock selection of MXL, XL, L, H, XH, XXH and Metric T pitches. Trapezoidal belts make an excellent means for transmitting power; however, time and technological advances have led to the more advanced product lines mentioned below.

Super Torque Pd® represents the next evolution in synchronous drive belt development in the Continental ContiTech line. The Super Torque Pd® belt has a unique modified round tooth design that minimizes tooth shear and operates quieter than traditional trapezoidal tooth profiles. Super Torque Pd® tooth pitches include S3M, S4.5M, S5M, S8M and S14M and are available as special manufactured parts with minimal runs.

SilentSync® belts and sprockets are a unique technological breakthrough. A patented Helical Offset Tooth (H.O.T.) design provides for continuous rolling tooth engagement, allowing the SilentSync® System to run quieter with less vibration than any other synchronous belt available today. With specialized materials, SilentSync® offers a much higher horsepower and temperature rating than its predecessor. The use of a flange-less sprocket also ensures more compact, lighter drives with precision performance.

SilentSync® belts and sprockets come in a wide variety of stock sizes with custom manufactured sizes being available for specialty drive requirements.

Falcon Pd® is a synchronous belt designed to handle increased horsepower, low torque applications. Falcon Pd® belts feature a high-grade rubber compound. This blended compound handles temperatures much higher than common polyurethane belts used in similar applications. Also, it is formulated to resist tooth deformity and increase tooth rigidity, extending belt life and saving you money. Falcon Pd® belts also feature a patented cord treatment which provides excellent dimensional stability and high-impact strength. Falcon Pd® belts can also be used in applications requiring backside idlers, allowing for greater flexibility in various applications. For ease of ordering, the Falcon Pd® part number interchanges with the Gates counterpart belt, making replacement easy.

Hawk Pd® with its strength and unique construction using our advanced compounding technology, is a line of curvilinear, synchronous belts that offers universal performance that stands alone. Designed to fit the majority of high-capacity synchronous application, Hawk Pd® belts fulfill existing drive requirements, matching industrial standards of belt width and length. With the Universal Profile Design (UPD), Hawk Pd® performs in the GT® and HTD® profiles, replacing Gates PowerGrip® HTD® and PowerGrip® GT® 2 belts.* In addition, Hawk Pd® replaces Carlisle RPP and RPP Plus belts,* running in RPP sprockets, as well as TB Wood's synchronous QD® profile.* The UPD is a simple solution in satisfying the multitude of belt and sprocket combinations in the market. Take universal performance to a higher level with Hawk Pd®.

Blackhawk Pd® is a high-performance, curvilinear belt that offers maximum performance in your 8mm and 14mm synchronous applications. Blackhawk Pd® is precisely designed and can replace existing Carlisle Panther®, Browning® Panther and TB Wood's QT Power Chain® belts, matching competitive offerings of belt width and length. Dynamic testing of Blackhawk Pd® has shown this durable belt actually lasts three to four times longer than Carlisle RPP Panther®. Maximize the performance of your timing belt application with Blackhawk Pd®, designed to deliver longer life and less maintenance. Choose the belt that takes performance to greater heights - Blackhawk Pd®.

*Trademarks of the Gates Corporation, Carlisle and TB Wood's Incorporated respectively.

SilentSync® Belts

The evolution continues with the next generation in synchronous belt technology

SilentSync® is the next generation in synchronous belt technology. This unique, state-of-the-art alternative to straight-tooth belts and drive chains has been enhanced to improve the overall performance of your drive design – and help you save energy.

SilentSync®

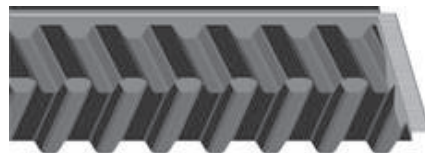

Part Number: B-1750

B	Blue = 14mm pitch, 35mm width
1750	1750mm pitch length

SilentSync® is the same Helical Offset Tooth (H.O.T.) design offering continuous rolling tooth engagement, ensuring a much quieter, synchronous drive with reduced vibration. A flangeless sprocket offering used with SilentSync® also provides a reduced weight, more compact drive providing efficiencies up to 98%.

SilentSync®'s high-strength aramid tensile member provides optimal resistance to flex fatigue, elongation and shock loads while operating at high torque conditions. The facing of SilentSync® belts also reduce tooth engagement friction while standing up to oil and chemical permeation.

DRIVE CHANGESM
MAXIMIZING YOUR EFFICIENCY

Higher horsepower rating

With the emergence of higher horsepower requirements and the need to reduce the size of drives, SilentSync®'s increased horsepower capacity, up to 25% improvement, has the ability to handle an even wider variety of applications. Newly-engineered materials and specialty compounds are formulated to give this next-generation SilentSync® belt more value in the most demanding applications.

Increased efficiency DriveChange™ opportunity

The unique tooth configuration of SilentSync® provides continuous tooth engagement and eliminates slippage. With a power efficiency rating of 98%, SilentSync® can offer you an impressive 5% edge over typical V-belt drives.

Improved operating temperature range

Knowing that elevated temperatures can significantly reduce belt life, we have made improvements in SilentSync®'s ability to perform at 200°F (93.3°C) continuous operation.

Simply stated, with SilentSync® you get what you pay for with each energy dollar. This is especially true when the SilentSync® is applied to high-energy consuming drives that are used 24 hours a day, as well as high horsepower drives that inflate energy consumption during peak periods.

With SilentSync®, you can experience a whole new level of performance and value in reinforced rubber synchronous belts.

A quieter, reduced vibration drive

The H.O.T. design of SilentSync® belts and sprockets reduces vibration and decreases operating noise by as much as 19 decibels versus other synchronous systems. This can lead to a quieter working environment with improved worker efficiency. Costs associated with monitoring, training and testing to meet OSHA regulations can be virtually eliminated with SilentSync® drives.

Belt materials compounded to last longer

Durability starts with the SilentSync® belt's rubber compound, a cross-linked elastomer formulated to resist tooth deformity and increase tooth rigidity. SilentSync® is also chemically stable to resist the effects of oils, coolants, heat and ozone.

Lower maintenance costs

Unlike chain drives, SilentSync® belts and sprockets do not require lubrication. After initial run in and rechecking tension after 8 hours of operation SilentSync® belts do not need additional retensioning like V-belts and chain.

Matching belt to sprocket has never been easier

The SilentSync® Color Spectrum System makes it the easiest power transmission drive to sell, purchase and install.

The part numbering system for SilentSync® centers around a color-coded sizing system for the belts and sprockets. Each belt and sprocket part number includes a letter corresponding to a color and is also branded in that color. The letters Y, W, P, B, G, O and R indicate the colors Yellow, White, Purple, Blue, Green, Orange and Red. All Yellow belts are designed to function with all Yellow sprockets, as is the case for the White, Purple, Blue, Green, Orange and Red sizes. An example of the part numbering system nomenclature for belts, sprockets and bushings follows and also appears on subsequent pages.

Belt part number nomenclature

G - 2800

G Green Color
2800 2800mm pitch length

Y - 896

Y Yellow Color
896 896mm pitch length

Applications

SilentSync® belts and sprockets are ideal on a wide variety of applications in all industries.

- > Agricultural equipment
- > Packaging conveyors
- > Aggregate crushers
- > Poultry/meat grinders
- > Wood debarkers and saws
- > Mining equipment
- > Aluminum/steel conveyors
- > Paper presses
- > Hog dehairers
- > Chain drives
- > Baking mixers
- > Textile machines
- > Horizontal drives
- > Printing machines

Key features & benefits

- > Reduced noise
- > Increased horsepower
- > Higher efficiency
- > Greater precision
- > Higher temperature operation
- > Less vibration
- > Less maintenance
- > Self-tracking
- > Bidirectional
- > Static conductive*

To learn more, visit www.contitech.us.

*Drive conditions and service variables in combination with time in operation can result in a loss of static conductivity. It is recommended that a conductivity check be added to drive preventive maintenance programs where belt static conductivity is a requirement.

SilentSync® Belts

Available Sizes

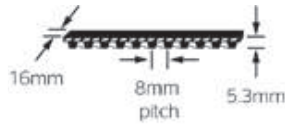

SilentSync® Yellow
8mm pitch - 16mm width

Part #*	# of Teeth	Length (in.)	Part #*	# of Teeth	Length (in.)
Y-640	80	25.20	Y-1280	160	50.39
Y-720	90	28.35	Y-1440	180	56.69
Y-800	100	31.50	Y-1600	200	62.99
Y-896	112	35.28	Y-1792	224	70.55
Y-1000	125	39.37	Y-2000	250	78.74
Y-1120	140	44.09	Y-2240	280	88.19
Y-1200	150	47.24	Y-2400	300	94.49

*The belt length in millimeters is given in the part number.

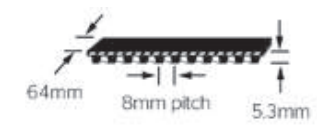

SilentSync® Purple
8mm pitch - 64mm width

Part #*	# of Teeth	Length (in.)	Part #*	# of Teeth	Length (in.)
P-720	90	28.35	P-1200	150	47.24
P-800	100	31.50	P-1280	160	50.39
P-896	112	35.28	P-1440	180	56.69
P-1000	125	39.37	P-1600	200	62.99
P-1120	140	44.09			

*The belt length in millimeters is given in the part number.

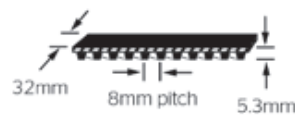

SilentSync® White
8mm pitch - 32mm width

Part #*	# of Teeth	Length (in.)	Part #*	# of Teeth	Length (in.)
W-640	80	25.20	W-1280	160	50.39
W-720	90	28.35	W-1440	180	56.69
W-800	100	31.50	W-1600	200	62.99
W-896	112	35.28	W-1792	224	70.55
W-1000	125	39.37	W-2000	250	78.74
W-1120	140	44.09	W-2240	280	88.19
W-1200	150	47.24	W-2400	300	94.49

*The belt length in millimeters is given in the part number.

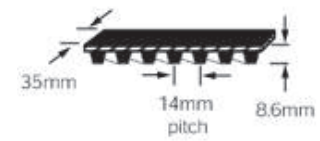

SilentSync® Blue
14mm pitch - 35mm width

Part #*	# of Teeth	Length (in.)	Part #*	# of Teeth	Length (in.)
B-994	71	39.13	B-2240	160	88.19
B-1120	80	44.09	B-2380	170	93.70
B-1190	85	46.85	B-2520	180	99.21
B-1260	90	49.61	B-2660	190	104.72
B-1400	100	55.12	B-2800	200	110.24
B-1568	112	61.73	B-3136	224	123.46
B-1750	125	68.90	B-3304	236	130.08
B-1960	140	77.17	B-3500	250	137.80
B-2100	150	82.68	B-3920	280	154.33

*The belt length in millimeters is given in the part number.

SilentSync® Green
14mm pitch - 52.5mm width

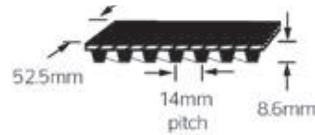

Part #*	# of Teeth	Length (in.)	Part #*	# of Teeth	Length (in.)
G-994	71	39.13	G-2240	160	88.19
G-1120	80	44.09	G-2380	170	93.70
G-1190	85	46.85	G-2520	180	99.21
G-1260	90	49.61	G-2660	190	104.72
G-1400	100	55.12	G-2800	200	110.24
G-1568	112	61.73	G-3136	224	123.46
G-1750	125	68.90	G-3304	236	130.08
G-1960	140	77.17	G-3500	250	137.80
G-2100	150	82.68	G-3920	280	154.33

*The belt length in millimeters is given in the part number.

SilentSync® Orange
14mm pitch - 70mm width

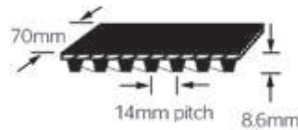

Part #*	# of Teeth	Length (in.)	Part #*	# of Teeth	Length (in.)
O-1120	80	44.09	O-2380	170	93.70
O-1190	85	46.85	O-2520	180	99.21
O-1260	90	49.61	O-2660	190	104.72
O-1400	100	55.12	O-2800	200	110.24
O-1568	112	61.73	O-3136	224	123.46
O-1750	125	68.90	O-3304	236	130.08
O-1960	140	77.17	O-3500	250	137.80
O-2100	150	82.68	O-3920	280	154.33
O-2240	160	88.19			

*The belt length in millimeters is given in the part number.

SilentSync® Red
14mm pitch - 105mm width

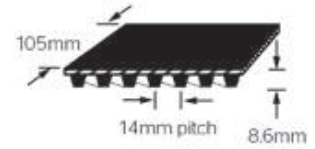

Part #*	# of Teeth	Length (in.)	Part #*	# of Teeth	Length (in.)
R-1260	90	49.61	R-2520	180	99.21
R-1400	100	55.12	R-2660	190	104.72
R-1568	112	61.73	R-2800	200	110.24
R-1750	125	68.90	R-3136	224	123.46
R-1960	140	77.17	R-3304	236	130.08
R-2100	150	82.68	R-3500	250	137.80
R-2240	160	88.19	R-3920	280	154.33
R-2380	170	93.70			

*The belt length in millimeters is given in the part number.

SilentSync® Sprockets

Sprocket combinations to fit your drive system's needs



SilentSync® sprockets have been designed to ensure maximum service life and performance. Over 1,500 sprocket combinations are available, making it easier to match the desired design speed. More speed ratio options also means more design flexibility and more compact drives.

Part Number: Y-28S-H

Y	Yellow=8mm pitch, 16mm width
28	28 teeth
S	Sprocket
H	Hub/bushing type

SilentSync® sprockets do not require flanges and are stocked in ductile iron constructions. Other materials such as aluminum, steel and stainless steel are available upon request as made-to-order items.



Matching belt to sprocket has never been easier

The part numbering system for SilentSync® centers around a color-coded sizing system for the belts and sprockets. Each belt and sprocket part number includes a letter corresponding to a color and is also branded in that color. The letters Y, W, P, B, G, O and R indicate the colors Yellow, White, Purple, Blue, Green, Orange and Red. All Yellow belts are designed to function with all Yellow sprockets, as is the case for the White, Purple, Blue, Green, Orange and Red sizes. An example of the part numbering system nomenclature for sprockets and bushings is given below.

Sprocket part number nomenclature

Minimum Plain Bore (MPB) **O-40S-MPB**

This is an Orange size sprocket with 40 teeth and a Minimum Plain Bore (MPB) style hub. The MPB style sprockets are supplied with a minimum bore, typically 1/2 inch or 1 inch with H7 tolerances and will require machining of a keyway and setscrew holes and possibly boring to a desired bore size.

Quick Disconnect (QD®) **R-168S-N**

This is a Red size sprocket with 168 teeth and hub machined to fit an "N" size QD® bushing. A bushing is required to install this sprocket on a shaft. Please note that smaller diameter sprockets are not available in the QD® style due to space limitations.

Finished Stock Bore (FSB)

G-34S - 1 1/8

This is a Green size sprocket with 34 teeth and a Finished Stock Bore (FSB) style hub featuring a bore of 1 1/8 inches. FSB sprockets are supplied ready to install with a standard keyway and setscrew holes machined.

Bored To Suit (BTS)

B-28S-BTS - 1 13/16

This is a Blue size sprocket with 28 teeth and a hub that has been bored (BTS) to 1 13/16 inches, per customer specification and machined for setscrew holes and a keyway. BTS sprockets can be made to almost any bore including metric sizes.

Note: All MPB-, QD®- and FSB-style sprockets are stock items. BTS sprockets are made to order and may require lead times.

Bushing part number nomenclature

E 2 1/2	E	Bushing size
	2 1/2	Bushing bore

Bushings are supplied with bolts, lock washers and set screws. Keys are supplied only if a special shallow key is required. The E 2 1/2 inch bushing can be used to install any sprocket with an "E" hub on a 2 1/2 inch shaft. The QD® bushing system is an industry standard, however, to ensure the best match between sprocket and bushing, we recommend using bushings supplied by Continental ContiTech for SilentSync® sprockets.

Applications

SilentSync® belts and sprockets are ideal for use on a wide variety of applications in all industries.

Key features & benefits

- › More design flexibility with more compact drives
- › No flanges
- › Self-tracking design
- › Available in ductile iron, aluminum, steel or stainless steel

Available Sizes

SilentSync® Yellow
8mm pitch - 17mm width



SAP #	Part #	# of Teeth	SAP #	Part #	# of Teeth
20038734	Y-18S-MPB	18	20038774	Y-40S-MPB	40
20038735	Y-18S-BTS-7/8*	18	20038775	Y-44S-MPB	44
20038737	Y-20S-MPB	20	20038776	Y-45S-SDS	45
20038738	Y-20S-BTS-7/8*	20	20038777	Y-45S-MPB	45
20038739	Y-20S-BTS-1-1/8*	20	20038778	Y-48S-SDS	48
20038741	Y-22S-MPB	22	20038779	Y-48S-MPB	48
20038742	Y-22S-BTS-7/8*	22	20038780	Y-50S-SDS	50
20038743	Y-22S-BTS-1-1/8*	22	20038781	Y-50S-MPB	50
20038745	Y-24S-MPB	24	20038782	Y-52S-MPB	52
20038746	Y-24S-BTS-7/8*	24	20038783	Y-56S-SDS	56
20038747	Y-24S-BTS-1-1/8*	24	20038784	Y-56S-MPB	56
20038748	Y-24S-BTS-1-3/8*	24	20038785	Y-60S-SDS	60
20038750	Y-25S-MPB	25	20038786	Y-60S-MPB	60
20038751	Y-25S-BTS-7/8*	25	20038787	Y-63S-SDS	63
20038752	Y-25S-BTS-1-1/8*	25	20038788	Y-63S-MPB	63
20038753	Y-25S-BTS-1-3/8*	25	20038789	Y-64S-MPB	64
20038755	Y-26S-MPB	26	20038790	Y-68S-MPB	68
20038756	Y-26S-BTS-7/8*	26	20038791	Y-72S-MPB	72
20038757	Y-26S-BTS-1-1/8*	26	20038792	Y-75S-SDS	75
20038758	Y-26S-BTS-1-3/8*	26	20038793	Y-75S-MPB	75
20038759	Y-26S-BTS-1-5/8*	26	20038794	Y-76S-MPB	76
20038761	Y-28S-H*	28	20038795	Y-80S-SDS	80
20038762	Y-28S-MPB	28	20038796	Y-80S-MPB	80
20038763	Y-30S-H*	30	20038797	Y-90S-SK	90
20038764	Y-30S-MPB	30	20038798	Y-90S-MPB	90
20038765	Y-32S-H*	32	20038799	Y-112S-SK	112
20038766	Y-32S-MPB	32	20038800	Y-112S-MPB	112
20038767	Y-34S-H*	34	20038801	Y-140S-SK	140
20038768	Y-34S-MPB	34	20038802	Y-140S-MPB	140
20038769	Y-36S-SH	36	20038803	Y-180S-SF	180
20038770	Y-36S-MPB	36	20038804	Y-180S-MPB	180
20038771	Y-38S-SH	38	20038805	Y-224S-E	224
20038772	Y-38S-MPB	38	20038806	Y-224S-MPB	224
20038773	Y-40S-SH	40			

"H" is a split taper bushing. "QT" is a QD bushing and is interchangeable with an "H" bushing.
Sprockets with Minimum Plain Bore (MPB) are specified when the sprocket does not allow room for a bushing that will handle the maximum load.

SilentSync® Sprockets

Available Sizes

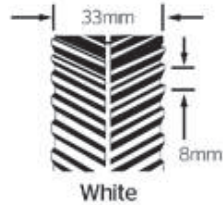

SilentSync® White
8mm pitch - 33mm width

SAP #	Part #	# of Teeth	SAP #	Part #	# of Teeth
20038821	W-18S-MPB	18	20038862	W-40S-MPB	40
20038822	W-18S-BTS-7/8"	18	20038863	W-44S-MPB	44
20038824	W-20S-MPB	20	20038864	W-45S-SDS	45
20038825	W-20S-BTS-7/8"	20	20038865	W-45S-MPB	45
20038826	W-20S-BTS-1-1/8"	20	20038866	W-48S-SDS	48
20038828	W-22S-MPB	22	20038892	W-48S-MPB	48
20038829	W-22S-BTS-7/8"	22	20038867	W-50S-SDS	50
20038830	W-22S-BTS-1-1/8"	22	20038868	W-50S-MPB	50
20038832	W-24S-MPB	24	20038870	W-52S-MPB	52
20038833	W-24S-BTS-7/8"	24	20038869	W-56S-SK	56
20038834	W-24S-BTS-1-1/8"	24	20038871	W-56S-MPB	56
20038835	W-24S-BTS-1-3/8"	24	20038872	W-60S-SK	60
20038837	W-25S-MPB	25	20038874	W-60S-MPB	60
20038838	W-25S-BTS-7/8"	25	20038875	W-63S-SK	63
20038839	W-25S-BTS-1-1/8"	25	20038893	W-63S-MPB	63
20038840	W-25S-BTS-1-3/8"	25	20038894	W-64S-MPB	64
20038842	W-26S-MPB	26	20038895	W-68S-MPB	68
20038843	W-26S-BTS-7/8"	26	20038877	W-72S-MPB	72
20038844	W-26S-BTS-1-1/8"	26	20038876	W-75S-SF	75
20038845	W-26S-BTS-1-3/8"	26	20038878	W-75S-MPB	75
20038846	W-26S-BTS-1-5/8"	26	20038879	W-76S-MPB	76
20038848	W-28S-H*	28	20038880	W-80S-SF	80
20038849	W-28S-MPB	28	20038881	W-80S-MPB	80
20038850	W-30S-H*	30	20038882	W-90S-SF	90
20038851	W-30S-MPB	30	20038883	W-90S-MPB	90
20038852	W-32S-H*	32	20038884	W-112S-SF	112
20038853	W-32S-MPB	32	20038885	W-112S-MPB	112
20038854	W-34S-SH	34	20038886	W-140S-E	140
20038855	W-34S-MPB	34	20038887	W-140S-MPB	140
20038856	W-36S-SH	36	20038888	W-180S-E	180
20038858	W-36S-MPB	36	20038889	W-180S-MPB	180
20038859	W-38S-SH	38	20038890	W-224S-F	224
20038860	W-38S-MPB	38	20038891	W-224S-MPB	224
20038861	W-40S-SH	40			

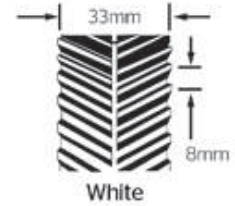

SilentSync® White Slab Sprockets

SAP #	Part #	# of Teeth	SAP #	Part #	# of Teeth
20133160	W-18S-SLB	18	20133178	W-40S-SLB	40
20133161	W-19S-SLB	19	20133179	W-42S-SLB	42
20110357	W-20S-SLB	20	20133180	W-44S-SLB	44
20133162	W-21S-SLB	21	20110355	W-45S-SLB	45
20133163	W-22S-SLB	22	20133181	W-46S-SLB	46
20133164	W-23S-SLB	23	20110354	W-48S-SLB	48
20133165	W-24S-SLB	24	20133182	W-50S-SLB	50
20133166	W-25S-SLB	25	20133183	W-52S-SLB	52
20110356	W-26S-SLB	26	20133184	W-54S-SLB	54
20133167	W-27S-SLB	27	20110353	W-56S-SLB	56
20133168	W-28S-SLB	28	20133185	W-58S-SLB	58
20133169	W-29S-SLB	29	20133186	W-60S-SLB	60
20133170	W-30S-SLB	30	20133187	W-63S-SLB	63
20133171	W-31S-SLB	31	20133188	W-64S-SLB	64
20110352	W-32S-SLB	32	20133189	W-68S-SLB	68
20133172	W-33S-SLB	33	20133190	W-70S-SLB	70
20133173	W-34S-SLB	34	20133191	W-72S-SLB	72
20133174	W-35S-SLB	35	20133192	W-75S-SLB	75
20133175	W-36S-SLB	36	20133193	W-76S-SLB	76
20133176	W-37S-SLB	37	20133194	W-80S-SLB	80
20133177	W-38S-SLB	38	20133195	W-90S-SLB	90
20132688	W-39S-SLB	39			

*"H" is a split taper bushing. "QT" is a QD® bushing and is interchangeable with an "H" bushing.

Sprockets with Minimum Plain Bore (MPB) are specified when the sprocket does not allow room for a bushing that will handle the maximum load.

SilentSync® Purple
8mm pitch - 65mm width

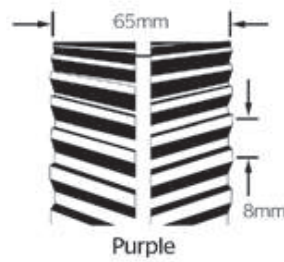

SAP #	Part #	# of Teeth	SAP #	Part #	# of Teeth
20160357	P-20S-MPB	20	20160370	P-45S-MPB	45
20160358	P-22S-MPB	22	20160371	P-48S-MPB	48
20160359	P-24S-MPB	24	20160372	P-50S-MPB	50
20160360	P-25S-MPB	25	20160373	P-52S-MPB	52
20160361	P-26S-MPB	26	20160374	P-56S-MPB	56
20160362	P-28S-MPB	28	20160375	P-60S-MPB	60
20160363	P-30S-MPB	30	20160376	P-63S-MPB	63
20160364	P-32S-MPB	32	20160377	P-64S-MPB	64
20160365	P-34S-MPB	34	20160378	P-68S-MPB	68
20160366	P-36S-MPB	36	20160379	P-72S-MPB	72
20160367	P-38S-MPB	38	20160384	P-112S-MPB	112
20160368	P-40S-MPB	40	20160385	P-120S-MPB	140
20160369	P-44S-MPB	44			

Sprockets with Minimum Plain Bore (MPB) are specified when the sprocket does not allow room for a bushing that will handle the maximum load.

SilentSync® Purple Slab Sprockets

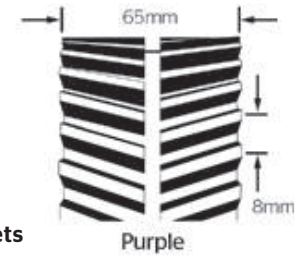

SAP #	Part #	# of Teeth	SAP #	Part #	# of Teeth
20136320	P-25S-SLB	25	20136338	P-45S-SLB	45
20136321	P-26S-SLB	26	20136339	P-46S-SLB	46
20136322	P-27S-SLB	27	20136340	P-48S-SLB	48
20136323	P-28S-SLB	28	20136341	P-50S-SLB	50
20136324	P-29S-SLB	29	20136342	P-52S-SLB	52
20136325	P-30S-SLB	30	20136343	P-54S-SLB	54
20136326	P-31S-SLB	31	20136344	P-56S-SLB	56
20136327	P-32S-SLB	32	20136345	P-58S-SLB	58
20136328	P-33S-SLB	33	20136346	P-60S-SLB	60
20136329	P-34S-SLB	34	20136347	P-63S-SLB	63
20136330	P-35S-SLB	35	20136348	P-64S-SLB	64
20136331	P-36S-SLB	36	20136349	P-68S-SLB	68
20136332	P-37S-SLB	37	20136350	P-70S-SLB	70
20136333	P-38S-SLB	38	20136351	P-72S-SLB	72
20136334	P-39S-SLB	39	20136352	P-75S-SLB	75
20136335	P-40S-SLB	40	20136353	P-76S-SLB	76
20136336	P-42S-SLB	42	20136354	P-80S-SLB	80
20136337	P-44S-SLB	44	20136355	P-90S-SLB	90

SilentSync® Sprockets

Available Sizes

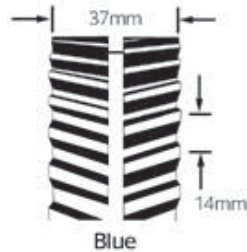

SilentSync® Blue

14mm pitch - 37mm width

SAP #	Part #	# of Teeth	SAP #	Part #	# of Teeth
20038910	B-28S-SK	28	20038933	B-56S-MPB	56
20038911	B-28S-MPB	28	20038934	B-60S-E	60
20038912	B-30S-SK	30	20038935	B-60S-MPB	60
20038913	B-30S-MPB	30	20038936	B-63S-F	63
20038914	B-32S-SK	32	20038937	B-63S-MPB	63
20038915	B-32S-MPB	32	20038938	B-71S-F	71
20038916	B-34S-SK	34	20038939	B-71S-MPB	71
20038917	B-34S-MPB	34	20038940	B-75S-F	75
20038918	B-36S-SF	36	20038941	B-75S-MPB	75
20038919	B-36S-MPB	36	20038942	B-80S-F	80
20038920	B-38S-SF	38	20038943	B-80S-MPB	80
20038921	B-38S-MPB	38	20038944	B-90S-F	90
20038922	B-40S-SF	40	20038945	B-90S-MPB	90
20038923	B-40S-MPB	40	20038946	B-112S-F	112
20038924	B-43S-SF	43	20038947	B-112S-MPB	112
20038925	B-43S-MPB	43	20038948	B-140S-J	140
20038926	B-45S-SF	45	20038949	B-140S-MPB	140
20038927	B-45S-MPB	45	20038950	B-168S-J	168
20038928	B-48S-SF	48	20038951	B-168S-MPB	168
20038929	B-48S-MPB	48	20355601	B-180S-E*	180
20038930	B-50S-E	50	20355602	B-200S-E*	200
20038931	B-50S-MPB	50	20493415	B-224S-E*	224
20038932	B-56S-E	56			

Sprockets with Minimum Plain Bore (MPB) are specified when the sprocket does not allow room for a bushing that will handle the maximum load.

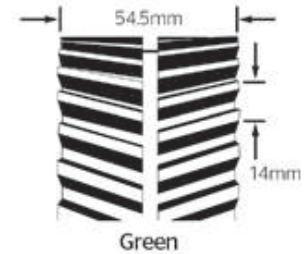

SilentSync® Green

14mm pitch - 54.5mm width

SAP #	Part #	# of Teeth	SAP #	Part #	# of Teeth
20038966	G-28S-MPB	28	20038998	G-48S-MPB	48
20038968	G-28S-BTS-1-7/8"	28	20038999	G-50S-E	50
20038969	G-28S-BTS-2-1/8"	28	20039000	G-50S-MPB	50
20038970	G-28S-BTS-2-3/8"	28	20039001	G-56S-E	56
20038972	G-30S-MPB	30	20039002	G-56S-MPB	56
20038973	G-30S-BTS-1-7/8"	30	20039003	G-60S-E	60
20038974	G-30S-BTS-2-1/8"	30	20039004	G-60S-MPB	60
20038975	G-30S-BTS-2-3/8"	30	20039005	G-63S-F	63
20038977	G-32S-MPB	32	20039006	G-63S-MPB	63
20038978	G-32S-BTS-1-7/8"	32	20039007	G-71S-J	71
20038979	G-32S-BTS-2-1/8"	32	20039008	G-71S-MPB	71
20038980	G-32S-BTS-2-3/8"	32	20039009	G-75S-J	75
20038982	G-34S-MPB	34	20039010	G-75S-MPB	75
20038983	G-34S-BTS-1-7/8"	34	20039011	G-80S-J	80
20038984	G-34S-BTS-2-1/8"	34	20039012	G-80S-MPB	80
20038985	G-34S-BTS-2-3/8"	34	20039013	G-90S-J	90
20038987	G-36S-SF	36	20039014	G-90S-MPB	90
20038988	G-36S-MPB	36	20039015	G-112S-J	112
20038989	G-38S-SF	38	20039020	G-112S-MPB	112
20038990	G-38S-MPB	38	20039016	G-140S-M	140
20038991	G-40S-SF	40	20039017	G-140S-MPB	140
20038992	G-40S-MPB	40	20039018	G-168S-M	168
20038993	G-43S-E	43	20039019	G-168S-MPB	168
20038994	G-43S-MPB	43	20308898	G-180S-F*	180
20038995	G-45S-E	45	20308899	G-200S-F*	200
20038996	G-45S-MPB	45	20526478	G-224S-F*	224
20038997	G-48S-E	48			

*Special lightweight design. Contact Continental ContiTech to ensure suitability for your application.

Sprockets with Minimum Plain Bore (MPB) are specified when the sprocket does not allow room for a bushing that will handle the maximum load.

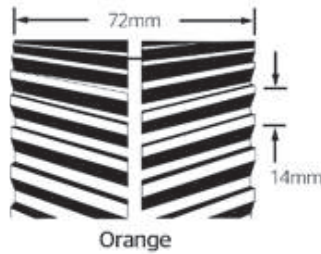

SilentSync® Orange
14mm pitch - 72mm width

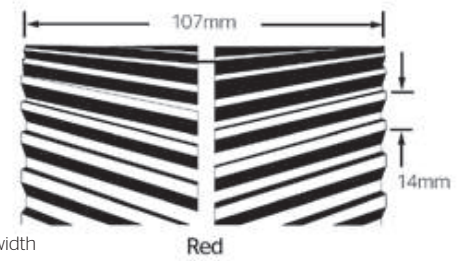

SilentSync® Red
14mm pitch - 107mm width

SAP #	Part #	# of Teeth	SAP #	Part #	# of Teeth
20039034	O-28S-MPB	28	20039070	O-40S-BTS-2-3/8"	40
20039035	O-28S-BTS-1-7/8"	28	20039071	O-40S-BTS-2-7/8"	40
20039036	O-28S-BTS-2-1/8"	28	20039073	O-43S-E	43
20039037	O-28S-BTS-2-3/8"	28	20039074	O-43S-MPB	43
20039039	O-30S-MPB	30	20039075	O-45S-E	45
20039040	O-30S-BTS-1-7/8"	30	20039076	O-45S-MPB	45
20039041	O-30S-BTS-2-1/8"	30	20039077	O-48S-E	48
20039042	O-30S-BTS-2-3/8"	30	20039078	O-48S-MPB	48
20039044	O-32S-MPB	32	20039079	O-50S-F	50
20039045	O-32S-BTS-1-7/8"	32	20039080	O-50S-MPB	50
20039046	O-32S-BTS-2-1/8"	32	20039081	O-56S-F	56
20039047	O-32S-BTS-2-3/8"	32	20039082	O-56S-MPB	56
20039048	O-32S-BTS-2-7/8"	32	20039083	O-60S-J	60
20039050	O-34S-MPB	34	20039084	O-60S-MPB	60
20039051	O-34S-BTS-1-7/8"	34	20039085	O-63S-J	63
20039052	O-34S-BTS-2-1/8"	34	20039086	O-63S-MPB	63
20039053	O-34S-BTS-2-3/8"	34	20039087	O-71S-J	71
20039054	O-34S-BTS-2-7/8"	34	20039103	O-71S-MPB	71
20039056	O-36S-MPB	36	20039088	O-75S-J	75
20039057	O-36S-BTS-1-7/8"	36	20039089	O-75S-MPB	75
20039058	O-36S-BTS-2-1/8"	36	20039090	O-80S-J	80
20083781	O-36S-BTS-2-3/8"	36	20039091	O-80S-MPB	80
20039059	O-36S-BTS-2-7/8"	36	20039092	O-90S-J	90
20039061	O-38S-MPB	38	20039093	O-90S-MPB	90
20039062	O-38S-BTS-1-7/8"	38	20039094	O-112S-M	112
20039063	O-38S-BTS-2-1/8"	38	20039095	O-112S-MPB	112
20039064	O-38S-BTS-2-3/8"	38	20039096	O-140S-M	140
20039065	O-38S-BTS-2-7/8"	38	20039097	O-140S-MPB	140
20039067	O-40S-MPB	40	20039098	O-168S-M	168
20039068	O-40S-BTS-1-7/8"	40	20039099	O-168S-MPB	168
20039069	O-40S-BTS-2-1/8"	40			

SAP #	Part #	# of Teeth	SAP #	Part #	# of Teeth
20039115	R-28S-MPB	28	20039154	R-40S-BTS-2-3/8"	40
20039116	R-28S-BTS-1-7/8"	28	20039155	R-40S-BTS-2-7/8"	40
20039117	R-28S-BTS-2-1/8"	28	20039157	R-43S-MPB	43
20039118	R-28S-BTS-2-3/8"	28	20039158	R-43S-BTS-1-7/8"	43
20039119	R-28S-BTS-2-7/8"	28	20039159	R-43S-BTS-2-1/8"	43
20039121	R-30S-MPB	30	20039160	R-43S-BTS-2-3/8"	43
20039122	R-30S-BTS-1-7/8"	30	20039161	R-43S-BTS-2-7/8"	43
20039123	R-30S-BTS-2-1/8"	30	20039163	R-45S-F	45
20039124	R-30S-BTS-2-3/8"	30	20039164	R-45S-MPB	45
20039125	R-30S-BTS-2-7/8"	30	20039165	R-48S-F	48
20039127	R-32S-MPB	32	20039166	R-48S-MPB	48
20039128	R-32S-BTS-1-7/8"	32	20039167	R-50S-J	50
20039129	R-32S-BTS-2-1/8"	32	20039168	R-50S-MPB	50
20039130	R-32S-BTS-2-3/8"	32	20039169	R-56S-J	56
20039131	R-32S-BTS-2-7/8"	32	20039170	R-56S-MPB	56
20039133	R-34S-MPB	34	20039171	R-60S-J	60
20039134	R-34S-BTS-1-7/8"	34	20039172	R-60S-MPB	60
20039135	R-34S-BTS-2-1/8"	34	20039173	R-63S-J	63
20039136	R-34S-BTS-2-3/8"	34	20039174	R-63S-MPB	63
20039137	R-34S-BTS-2-7/8"	34	20039175	R-71S-M	71
20039139	R-36S-MPB	36	20039190	R-71S-MPB	71
20039140	R-36S-BTS-1-7/8"	36	20039176	R-75S-M	75
20039141	R-36S-BTS-2-1/8"	36	20039177	R-75S-MPB	75
20039142	R-36S-BTS-2-3/8"	36	20039178	R-80S-M	80
20039143	R-36S-BTS-2-7/8"	36	20039179	R-80S-MPB	80
20039145	R-38S-MPB	38	20039180	R-90S-M	90
20039146	R-38S-BTS-1-7/8"	38	20039181	R-90S-MPB	90
20039147	R-38S-BTS-2-1/8"	38	20039182	R-112S-M	112
20039148	R-38S-BTS-2-3/8"	38	20039183	R-112S-MPB	112
20039149	R-38S-BTS-2-7/8"	38	20039184	R-140S-N	140
20039151	R-40S-MPB	40	20039185	R-140S-MPB	140
20039152	R-40S-BTS-1-7/8"	40	20039186	R-168S-N	168
20039153	R-40S-BTS-2-1/8"	40	20039187	R-168S-MPB	168

*Contact customer service for price and availability.
Sprockets with Minimum Plain Bore (MPB) are specified when the sprocket does not allow room for a bushing that will handle the maximum load.

Sprockets with Minimum Plain Bore (MPB) are specified when the sprocket does not allow room for a bushing that will handle the maximum load.

SilentSync® Sprockets

Available Sizes

SilentSync® Red Slab Sprockets

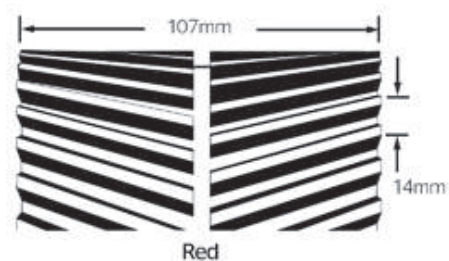

SAP #	Part #	# of Teeth	SAP #	Part #	# of Teeth
20133004	R-28S-SLB	28	20131755	R-45S-SLB	45
20133046	R-29S-SLB	29	20133081	R-46S-SLB	46
20133047	R-30S-SLB	30	20133082	R-48S-SLB	48
20133048	R-31S-SLB	31	20133083	R-50S-SLB	50
20133049	R-32S-SLB	32	20133084	R-52S-SLB	52
20133070	R-33S-SLB	33	20133085	R-54S-SLB	54
20133071	R-34S-SLB	34	20133086	R-56S-SLB	56
20133072	R-35S-SLB	35	20133087	R-58S-SLB	58
20133073	R-36S-SLB	36	20133088	R-60S-SLB	60
20133074	R-37S-SLB	37	20131351	R-63S-SLB	63
20133075	R-38S-SLB	38	20133089	R-70S-SLB	70
20133076	R-39S-SLB	39	20133005	R-71S-SLB	71
20133077	R-40S-SLB	40	20133090	R-75S-SLB	75
20133078	R-42S-SLB	42	20133091	R-80S-SLB	80
20133079	R-43S-SLB	43	20133092	R-90S-SLB	90
20133080	R-44S-SLB	44			

Falcon Pd® Belts

The star of our reinforced rubber power transmission belt portfolio



Falcon Pd® is quickly setting the new standard in synchronous drive system belting. When compared to conventional polyurethane synchronous belts, the benefits of Falcon Pd® become evident.

Part Number: 8GTR-640-12

8	8mm pitch length
GTR	Falcon Pd® belt
640	640mm pitch
12	12mm width

Specialty compounded materials give this belt superior advantages

The ability to operate continuously in temperatures up to 210°F (98.9°C) and withstand peak temperatures as high as 300°F (148.9°C), along with being static conductive, help Falcon Pd® perform in special applications, providing longer life and higher output to meet your needs.

- > Size for size convenience (example: 8GTR-640-21=Gates 8MGT®-640-21*)
- > Static conductive**
- > Reduced operating noise levels to comparable belt drives
- > Exceptional tensile strength for premium performance
- > Rubber construction provides better resistance to flex fatigue
- > Versatility in a wide range of operating temperatures

Lower maintenance costs reduce the pain

Falcon Pd® synchronous belts do not require lubrication often found in chain drive applications. High-modulus cord members minimize the need for retensioning normally required in standard V-belts, reducing your overall maintenance cost.

Quiet operation

Falcon Pd® runs quieter, up to 6dB in operation for a better environment while offering advanced flex-fatigue resistance to help extend belt life.

Applications

Any application where a chain drive could be used.

Can also be used with a backside idler when needed, allowing for additional applications.

Suitable for high horsepower, low torque drives.

Key features & benefits

- > Increased horsepower rating up to 36%
- > Increased continuous operating temperature up to 210°F (98.9°C)

Power Rating Comparison

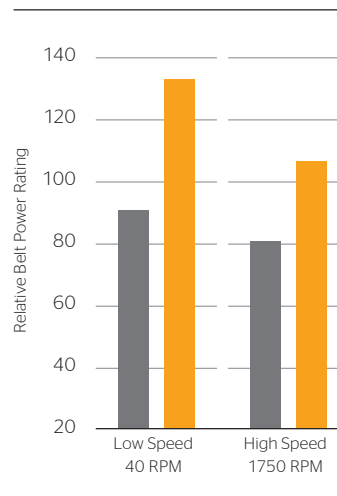

Conditions: 14mm pitch belt, 20mm width belt, 32 tooth sprockets

- █ Falcon HTC®
- █ Falcon Pd®

*Contact customer service for availability. Gates, Poly Chain and GT are trademarks of the Gates Corporation.

**Drive conditions and service variables in combination with time in operation can result in a loss of static conductivity. It is recommended that a conductivity check be added to drive preventive maintenance programs where belt static conductivity is a requirement.

Falcon Pd[®] Belts

Available Sizes

8m
8mm pitch

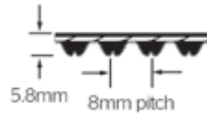

14m
14mm pitch

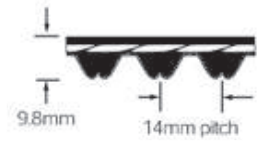

Pitch Length (mm)	Pitch Length (mm)	Pitch Length (mm)
640	1224	2520
720	1280	2840
800	1440	3200
896	1600	3600
960	1760	4000
1000	1792	4480
1040	2000	
1120	2240	
1200	2400	

Stock widths: 12mm, 21mm, 36mm, 62mm

Pitch Length (mm)	Pitch Length (mm)	Pitch Length (mm)
994	1960	3500
1120	2100	3850
1190	2240	3920
1260	2380	4326
1400	2520	4410
1568	2660	5166
1610	2800	6496
1750	3136	6636
1890	3304	

Stock widths: 20mm, 37mm, 68mm, 90mm, 125mm

Falcon Pd® Sprockets

Compact drives with high performance

Falcon Pd® sprockets are designed to be a part of a complete high performance drive system. Working with our premium synchronous Falcon Pd® belts allows for a lot of performance in a small space, giving you flexibility in design and application.

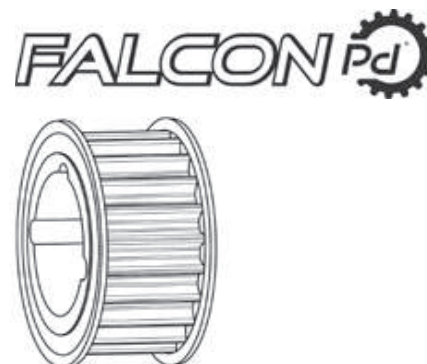

Part Number: GTR-22G-8M-12

GTR	Falcon Pd® sprocket
22G	22 grooves/teeth
8M	8mm pitch length
12	12mm width

Falcon Pd® belts and sprockets are ideal for use on a wide variety of applications and industries.

Matching belt to sprocket is simple

The part numbering system for Falcon Pd® sprockets is simple and easy. Just match the belt's width and pitch length to that of the sprocket and select the preferred number of grooves/teeth to provide the desired performance characteristics. Refer to the part number example above for a part number breakdown.



Get what you pay for Drive ChangeSM

With Falcon Pd® belts and sprockets, you get more of what you pay for with each energy dollar. This is especially true when Falcon Pd® is applied to high-energy consuming drives that are used 24 hours a day, as well as high horsepower drives that inflate energy consumption during peak periods.

Quieter, more flexible drive system

Falcon Pd® belt and sprocket systems also offer a decrease in operating noise. Tests show up to 6dB quieter operation than comparable Poly Chain GT® 2* and Poly Chain GT® Carbon* belt systems.

Proprietary rubber construction provides better resistance to flex fatigue and versatility in a wide range of operating temperatures.

A system that works with less maintenance

Since Falcon Pd® belts are made of our proprietary high-grade rubber compound, you get a solution that can handle very demanding synchronous drive systems. Falcon Pd® does not require lubrication. There is also no need for retensioning after the initial run in period like V-belts drives. Install a Falcon Pd® drive system and watch your maintenance costs drop.

Applications

Any applications where a chain drive could be used or there is a need for a high-efficiency drive system.

For use where Falcon Pd® belts are specified or desired.

System is backside idler compatible allowing for additional applications.

Key features & benefits

- › Continental ContiTech GTR-22G-8m-12 replaces 8MX-22S-12
- › Convenient replacement for existing Poly Chain® GT® 2* and Poly Chain GT® Carbon** drives
- › Cast iron or steel construction
- › Stock on most popular application sizes. Other sizes available as special order

*Gates, Poly Chain and GT are trademarks of the Gates Corporation.

Falcon Pd® Sprockets

Available Sizes

8m*

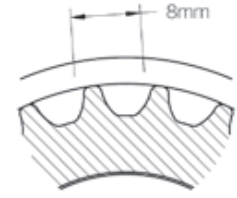

Part #	# of Teeth	Replaces Sprocket	Part #	# of Teeth	Replaces Sprocket
GTR-22G-8M-12-1008TL	22	8MX-22S-12	GTR-80G-8M-21-3020TL	80	8MX-80S-21
GTR-25G-8M-12-1108TL	25	8MX-25S-12	GTR-90G-8M-21-3020TL	90	8MX-90S-21
GTR-26G-8M-12-1108TL	26	8MX-26S-12	GTR-112G-8M-21-3020TL	112	8MX-112S-21
GTR-28G-8M-12-1108TL	28	8MX-28S-12	GTR-140G-8M-21-3020TL	140	8MX-140S-21
GTR-29G-8M-12-1108TL	29	8MX-29S-12	GTR-25G-8M-36-MPB	25	8MX-25S-36
GTR-30G-8M-12-1108TL	30	8MX-30S-12	GTR-28G-8M-36-MPB	28	8MX-28S-36
GTR-32G-8M-12-1210TL	32	8MX-32S-12	GTR-30G-8M-36-1615TL	30	8MX-30S-36
GTR-34G-8M-12-1610TL	34	8MX-34S-12	GTR-32G-8M-36-1615TL	32	8MX-32S-36
GTR-36G-8M-12-1610TL	36	8MX-36S-12	GTR-34G-8M-36-1615TL	34	8MX-34S-36
GTR-38G-8M-12-1610TL	38	8MX-38S-12	GTR-36G-8M-36-1615TL	36	8MX-36S-36
GTR-40G-8M-12-1610TL	40	8MX-40S-12	GTR-38G-8M-36-1615TL	38	8MX-38S-36
GTR-45G-8M-12-2012TL	45	8MX-45S-12	GTR-40G-8M-36-2012TL	40	8MX-40S-36
GTR-48G-8M-12-2012TL	48	8MX-48S-12	GTR-45G-8M-36-2012TL	45	8MX-45S-36
GTR-50G-8M-12-2012TL	50	8MX-50S-12	GTR-48G-8M-36-2012TL	48	8MX-48S-36
GTR-56G-8M-12-2012TL	56	8MX-56S-12	GTR-50G-8M-36-2012TL	50	8MX-50S-36
GTR-60G-8M-12-2012TL	60	8MX-60S-12	GTR-56G-8M-36-2517TL	56	8MX-56S-36
GTR-64G-8M-12-2012TL	64	8MX-64S-12	GTR-60G-8M-36-2517TL	60	8MX-60S-36
GTR-71G-8M-12-2012TL	71	8MX-71S-12	GTR-64G-8M-36-2517TL	64	8MX-64S-36
GTR-75G-8M-12-2012TL	75	8MX-75S-12	GTR-75G-8M-36-3020TL	75	8MX-75S-36
GTR-80G-8M-12-2012TL	80	8MX-80S-12	GTR-80G-8M-36-3020TL	80	8MX-80S-36
GTR-90G-8M-12-2012TL	90	8MX-90S-12	GTR-90G-8M-36-3020TL	90	8MX-90S-36
GTR-22G-8M-21-1008TL	22	8MX-22S-21	GTR-112G-8M-36-3020TL	112	8MX-112S-36
GTR-25G-8M-21-1108TL	25	8MX-25S-21	GTR-140G-8M-36-3020TL	140	8MX-140S-36
GTR-26G-8M-21-1108TL	26	8MX-26S-21	GTR-168G-8M-36-3020TL	168	8MX-168S-36
GTR-27G-8M-21-1108TL*	27	8MX-27S-21	GTR-30G-8M-62-1615TL	30	8MX-30S-62
GTR-28G-8M-21-1108TL	28	8MX-28S-21	GTR-32G-8M-62-1615TL	32	8MX-32S-62
GTR-30G-8M-21-1610TL	30	8MX-30S-21	GTR-34G-8M-62-1615TL	34	8MX-34S-62
GTR-32G-8M-21-1610TL	32	8MX-32S-21	GTR-36G-8M-62-1615TL	36	8MX-36S-62
GTR-33G-8M-21-1610TL*	33	8MX-33S-21	GTR-38G-8M-62-1615TL	38	8MX-38S-62
GTR-34G-8M-21-1610TL	34	8MX-34S-21	GTR-40G-8M-62-2012TL	40	8MX-40S-62
GTR-36G-8M-21-1610TL	36	8MX-36S-21	GTR-45G-8M-62-2012TL	45	8MX-45S-62
GTR-38G-8M-21-1610TL	38	8MX-38S-21	GTR-48G-8M-62-2517TL	48	8MX-48S-62
GTR-40G-8M-21-1610TL	40	8MX-40S-21	GTR-50G-8M-62-2517TL	50	8MX-50S-62
GTR-42G-8M-21-1610TL*	42	8MX-42S-21	GTR-56G-8M-62-2517TL	56	8MX-56S-62
GTR-45G-8M-21-2012TL	45	8MX-45S-21	GTR-60G-8M-62-2517TL	60	8MX-60S-62
GTR-48G-8M-21-2012TL	48	8MX-48S-21	GTR-64G-8M-62-2517TL	64	8MX-64S-62
GTR-50G-8M-21-2012TL	50	8MX-50S-21	GTR-75G-8M-62-3020TL	75	8MX-75S-62
GTR-53G-8M-21-2012TL*	53	8MX-53S-21	GTR-80G-8M-62-3020TL	80	8MX-80S-62
GTR-56G-8M-21-2012TL	56	8MX-56S-21	GTR-90G-8M-62-3020TL	90	8MX-90S-62
GTR-60G-8M-21-2517TL	60	8MX-60S-21	GTR-112G-8M-62-3020TL	112	8MX-112S-62
GTR-64G-8M-21-2517TL	64	8MX-64S-21	GTR-140G-8M-62-3030TL	140	8MX-140S-62
GTR-75G-8M-21-2517TL	75	8MX-75S-21			

8m sprockets are flanged through 80 grooves/teeth. 8m 80 groove/tooth sprockets can have laser cut flanges added. Contact customer service for price and delivery.

Most Falcon Pd® sprockets use taper-lock bushings.

*Inventories continue to evolve, contact customer service for the latest stocking levels.

Falcon Pd[®] Sprockets

Available Sizes

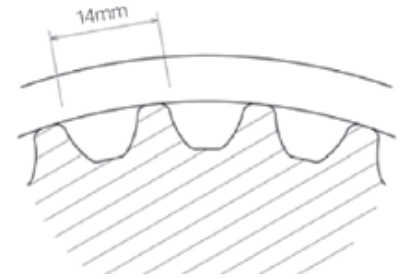

14m*

Part #	# of Teeth	Replaces Sprocket	Part #	# of Teeth	Replaces Sprocket	Part #	# of Teeth	Replaces Sprocket
GTR-28G-14M-20-2012TL	28	14MX-28S-20	GTR-36G-14M-37-SF	36	14MX-36S-37	GTR-168G-14M-68-4040TL	168	14MX-168S-68
GTR-29G-14M-20-2012TL*	29	14MX-29S-20	GTR-38G-14M-37-2517TL	38	14MX-38S-37	GTR-180G-14M-68-4040TL	180	14MX-180S-68
GTR-30G-14M-20-2012TL	30	14MX-30S-20	GTR-40G-14M-37-2517TL	40	14MX-40S-37	GTR-30G-14M-90-MPB	30	14MX-30S-90
GTR-30G-14M-20-SK	30	14MX-30S-20	GTR-44G-14M-37-3020TL	44	14MX-44S-37	GTR-32G-14M-90-MPB	32	14MX-32S-90
GTR-32G-14M-20-2012TL	32	14MX-32S-20	GTR-48G-14M-37-3020TL	48	14MX-48S-37	GTR-34G-14M-90-3020TL	34	14MX-34S-90
GTR-32G-14M-20-SK	32	14MX-32S-20	GTR-50G-14M-37-3020TL	50	14MX-50S-37	GTR-36G-14M-90-3020TL	36	14MX-36S-90
GTR-34G-14M-20-2517TL	34	14MX-34S-20	GTR-56G-14M-37-3020TL	56	14MX-56S-37	GTR-38G-14M-90-3020TL	38	14MX-38S-90
GTR-34G-14M-20-SK	34	14MX-34S-20	GTR-60G-14M-37-3020TL	60	14MX-60S-37	GTR-40G-14M-90-3020TL	40	14MX-40S-90
GTR-36G-14M-20-2517TL	36	14MX-36S-20	GTR-64G-14M-37-3020TL	64	14MX-64S-37	GTR-44G-14M-90-3030TL	44	14MX-44S-90
GTR-36G-14M-20-SF	36	14MX-36S-20	GTR-72G-14M-37-3020TL	72	14MX-72S-37	GTR-48G-14M-90-3030TL	48	14MX-48S-90
GTR-38G-14M-20-2517TL	38	14MX-38S-20	GTR-80G-14M-37-3020TL	80	14MX-80S-37	GTR-50G-14M-90-3535TL	50	14MX-50S-90
GTR-40G-14M-20-2517TL	40	14MX-40S-20	GTR-90G-14M-37-3020TL	90	14MX-90S-37	GTR-56G-14M-90-3535TL	56	14MX-56S-90
GTR-44G-14M-20-3020TL	44	14MX-44S-20	GTR-112G-14M-37-3535TL	112	14MX-112S-37	GTR-60G-14M-90-3535TL	60	14MX-60S-90
GTR-48G-14M-20-3020TL	48	14MX-48S-20	GTR-140G-14M-37-3535TL	140	14MX-140S-37	GTR-64G-14M-90-3535TL	64	14MX-64S-90
GTR-50G-14M-20-3020TL	50	14MX-50S-20	GTR-180G-14M-37-E	180	14MX-180S-37	GTR-72G-14M-90-3535TL	72	14MX-72S-90
GTR-56G-14M-20-3020TL	56	14MX-56S-20	GTR-200G-14M-37-E	200	14MX-200S-37	GTR-80G-14M-90-3535TL	80	14MX-80S-90
GTR-60G-14M-20-3020TL	60	14MX-60S-20	GTR-224G-14M-37-E	224	14MX-224S-37	GTR-90G-14M-90-3535TL	90	14MX-90S-90
GTR-64G-14M-20-3020TL	64	14MX-64S-20	GTR-28G-14M-68-2517TL	28	14MX-28S-68	GTR-112G-14M-90-4040TL	112	14MX-112S-90
GTR-72G-14M-20-3020TL	72	14MX-72S-20	GTR-29G-14M-68-2517TL	29	14MX-29S-68	GTR-140G-14M-90-4040TL	140	14MX-140S-90
GTR-80G-14M-20-3020TL	80	14MX-80S-20	GTR-30G-14M-68-2517TL	30	14MX-30S-68	GTR-168G-14M-90-5050TL	168	14MX-168S-90
GTR-90G-14M-20-3020TL	90	14MX-90S-20	GTR-32G-14M-68-2517TL	32	14MX-32S-68	GTR-38G-14M-125-3535TL	38	14MX-38S-125
GTR-112G-14M-20-3020TL	112	14MX-112S-20	GTR-34G-14M-68-3020TL	34	14MX-34S-68	GTR-40G-14M-125-3535TL	40	14MX-40S-125
GTR-140G-14M-20-3020TL	140	14MX-140S-20	GTR-36G-14M-68-3020TL	36	14MX-36S-68	GTR-44G-14M-125-3535TL	44	14MX-44S-125
GTR-168G-14M-20-3020TL	168	14MX-168S-20	GTR-38G-14M-68-3020TL	38	14MX-38S-68	GTR-48G-14M-125-3535TL	48	14MX-48S-125
GTR-180G-14M-20-E	180	14MX-180S-20	GTR-40G-14M-68-3020TL	40	14MX-40S-68	GTR-50G-14M-125-3535TL	50	14MX-50S-125
GTR-200G-14M-20-E*	200	14MX-200S-20	GTR-44G-14M-68-3030TL	44	14MX-44S-68	GTR-56G-14M-125-3535TL	56	14MX-56S-125
GTR-224G-14M-20-E*	224	14MX-224S-20	GTR-48G-14M-68-3030TL	48	14MX-48S-68	GTR-60G-14M-125-4040TL	60	14MX-60S-125
GTR-28G-14M-37-2012TL	28	14MX-28S-37	GTR-50G-14M-68-3535TL	50	14MX-50S-68	GTR-64G-14M-125-4040TL	64	14MX-64S-125
GTR-29G-14M-37-2012TL	29	14MX-29S-37	GTR-56G-14M-68-3535TL	56	14MX-56S-68	GTR-72G-14M-125-4040TL	72	14MX-72S-125
GTR-30G-14M-37-2012TL	30	14MX-30S-37	GTR-60G-14M-68-3535TL	60	14MX-60S-68	GTR-80G-14M-125-4040TL	80	14MX-80S-125
GTR-30G-14M-37-SK*	30	14MX-30S-37	GTR-64G-14M-68-3535TL	64	14MX-64S-68	GTR-90G-14M-125-4040TL	90	14MX-90S-125
GTR-32G-14M-37-2012TL*	32	14MX-32S-37	GTR-72G-14M-68-3535TL	72	14MX-72S-68	GTR-112G-14M-125-5050TL	112	14MX-112S-125
GTR-32G-14M-37-SK*	32	14MX-32S-37	GTR-80G-14M-68-3535TL	80	14MX-80S-68	GTR-140G-14M-125-5050TL	140	14MX-140S-125
GTR-34G-14M-37-2517TL*	34	14MX-34S-37	GTR-90G-14M-68-3535TL	90	14MX-90S-68	GTR-168G-14M-125-5050TL*	168	14MX-168S-125
GTR-34G-14M-37-SK*	34	14MX-34S-37	GTR-112G-14M-68-3535TL	112	14MX-112S-68	GTR-180G-14M-125-6050TL**	180	14MX-180S-125
GTR-36G-14M-37-2517TL*	36	14MX-36S-37	GTR-140G-14M-68-4040TL	140	14MX-140S-68			

14m 72 and 80 groove/tooth sprockets can have laser cut flanges added. Contact customer service for price and delivery. Most Falcon Pd[®] sprockets use taper-lock bushings.

*Inventories continue to evolve, contact customer service for the latest stocking levels.

**Available with QD[®] Bushing.

^Special lightweight design, contact Continental ContiTech to ensure suitability for your application.

Hawk Pd[®] Belts

A high-performance synchronous belt with a universal profile

With its universal tooth profile, Hawk Pd[®] is precisely designed and manufactured to fit the majority of existing high-capacity synchronous applications. Hawk Pd[®] can fulfill most existing drive requirements in its class matching competitive offerings of belt width and length.

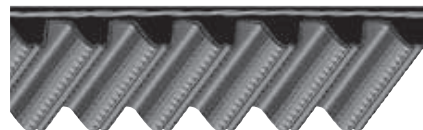

Part Number: 480-8M-20

480	480mm pitch length
8m	8mm pitch
20	20mm wide

Sprocket compatibility with Gates HTD[®],** Power Grip GT[®]** and GT[®]2,* Carlisle RPP and RPP Plus[™]** and TB Wood's Synchronous QD[®]** Industry-compatible nomenclature for easy part number interchange.

Belt materials that last longer

Hawk Pd[®] belts feature an enhanced rubber compound. This compound is formulated to resist tooth deformity and increase tooth rigidity, increasing belt life and decreasing replacement costs.

The demands of synchronous drives put additional strain on the belt and tooth surface for high-speed and low-speed applications. The Hawk Pd[®] tooth profile resists ratcheting and provides accurate positioning for synchronous drive applications. Enhanced Continental ContiTech materials and tooth profile enable the teeth to engage the sprocket smoothly.

High capacity performance

Hawk Pd[®] synchronous belts are designed for high-capacity performance, exceeding the traditional speed limitations of chain and performance limitations of belt drives. The new material technology delivers a higher horsepower rating and improved life.

Lower maintenance costs

Unlike chain drives, Hawk Pd[®] belts and matching sprockets do not require lubrication. There is also virtually no need for retensioning like there is for V-belts and chain drives. Install Hawk Pd[®] and reduce your maintenance costs.

Applications

Nearly every conceivable industrial drive application where shaft synchronization is required. Hawk Pd[®] belts can also be used as an alternative to problem V-belt and chain drives.

- › Aggregate machinery
- › Paper industry machinery
- › Printing trade machinery
- › Food processing equipment
- › Packaging machinery
- › Mining equipment
- › Woodworking machinery
- › Office equipment
- › Machine tool
- › Home appliances
- › HVAC units
- › Textile machinery
- › Farm machinery
- › Vending machines

Key features & benefits

- › Universal tooth profile drops into existing Pd[®] GT[®]** and RPP sprockets. Industry-compatible nomenclature.
- › High-grade compounding.
- › Requires little, if any, retensioning and less drive maintenance.
- › Oil, heat, ozone and abrasion resistant.
- › Designed for high-capacity performance.
- › Higher horsepower rating than traditional timing belts.

To learn more, visit www.contitech.us.

Available Sizes

In addition to our stock lineup of synchronous belts, we can manufacture additional sizes (lengths) not listed.

For full product availability and specifications, please visit www.contitech.us or contact a Sales Representative.



3m

Pitch Length (mm)	Pitch Length (mm)
159*	612*
204*	633*
252*	675*
264*	738*
312*	

*Nonstock, made to order. Minimum quantities required.

5m

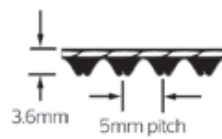

Pitch Length (mm)	Pitch Length (mm)	Pitch Length (mm)
350	635	1125
375	670	1195
400	710	1270
425	740	1420
450	800	1595
475	850	1690
500	890	1790
535	950	1895
565	1000	2000
600	1050	

Stock widths: 9mm, 15mm, 25mm

8m*

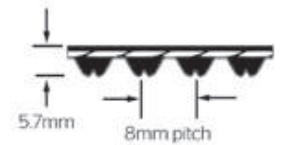

Pitch Length (mm)	Pitch Length (mm)	Pitch Length (mm)
480	1120	2400
560	1200	2600
600	1280	2800
640	1440	3048
720	1600	3280
800	1760	3600
880	1800	4400
960	2000	
1040	2200	

Stock widths: 20mm, 30mm, 50mm, 85mm

*Static conductive

14m*

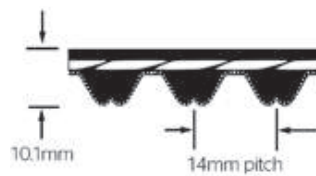

Pitch Length (mm)	Pitch Length (mm)	Pitch Length (mm)
966	2450	4578
1190	2590	4956
1400	2800	5320
1610	3150	5740
1778	3360	6160
1890	3500	6860
2100	3850	
2310	4326	

Stock widths: 40mm, 55mm, 85mm, 115mm, 170mm

*Static conductive

20m*

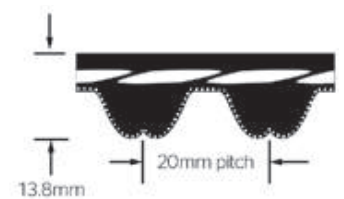

Pitch Length (mm)	Pitch Length (mm)	Pitch Length (mm)
2000	4200	5400
2500	4600	5800
3400	5000	6200
3800	5200	6600

Stock widths: 115mm, 170mm, 230mm, 290mm, 340mm

*Static conductive

*Drive conditions and service variables in combination with time in operation can result in a loss of static conductivity. It is recommended that a conductivity check be added to drive preventive maintenance programs where belt static conductivity is a requirement.

Hawk Pd® Sprockets

Available Sizes

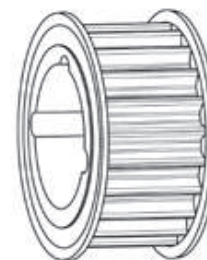

5mm Synchronous Sprockets

Part #	SAP #	Weight*	Part #	SAP #	Weight*
P32-5M-15-MPB	20182279	0.8	P56-5M-15-SH	20182400	1.5
P32-5M-25-MPB	20182280	1.1	P56-5M-25-SH	20182401	1.7
P34-5M-15-MPB	20182292	1.0	P60-5M-15-SH	20182417	1.8
P34-5M-25-MPB	20182293	1.3	P60-5M-25-SH	20182418	2.1
P36-5M-15-MPB	20182307	1.1	P64-5M-15-SH	20182429	2.0
P36-5M-25-MPB	20182308	1.5	P64-5M-25-SH	20182430	2.3
P38-5M-15-JA	20182323	0.6	P68-5M-15-SDS	20182446	2.0
P38-5M-25-JA	20182324	0.9	P68-5M-25-SDS	20182447	2.4
P40-5M-15-JA	20182339	0.7	P72-5M-15-SDS	20182458	2.3
P40-5M-25-JA	20182340	1.1	P72-5M-25-SDS	20182459	2.7
P44-5M-15-JA	20182355	1.0	P80-5M-15-SDS	20182475	3.1
P44-5M-25-JA	20182356	1.4	P80-5M-25-SDS	20182476	3.5
P48-5M-15-JA	20182371	1.0	P90-5M-15-SDS	20182492	4.1
P48-5M-25-JA	20182372	1.2	P90-5M-25-SDS	20182493	4.6
P52-5M-15-JA	20182388	1.2	P112-5M-15-SDS	20182192	5.9
P52-5M-25-JA	20182389	1.4	P112-5M-25-SDS	20182193	5.9

*Weight does not include bushing.

Sprockets with Minimum Plain Bore (MPB) are specified when the sprocket does not allow room for a bushing that will handle the maximum load.

Part Number: P34-14M-55-SK

P34	34 grooves/teeth
14	14mm pitch length
55	55mm width
SK	QD® bushing

8mm Synchronous Sprockets

Part #	SAP #	Weight*	Part #	SAP #	Weight*	Part #	SAP #	Weight*
P22-8M-20-MPB	20182242	1.2	P36-8M-85-SKL	20182313	3.0	P64-8M-30-SK	20182432	8.4
P22-8M-30-MPB	20182243	1.5	P38-8M-20-SH	20182325	2.0	P64-8M-50-SK	20182433	10.0
P24-8M-20-JA	20182244	0.7	P38-8M-30-SH	20182326	2.3	P64-8M-85-SF	20182434	12.2
P24-8M-30-JA	20182245	0.8	P38-8M-50-SH	20182327	3.1	P72-8M-20-SDS	20182460	5.8
P26-8M-20-JA	20182247	0.8	P38-8M-85-SKL	20182329	3.8	P72-8M-30-SK	20182461	8.0
P26-8M-30-JA	20182248	0.9	P40-8M-20-SH	20182341	2.2	P72-8M-50-SK	20182462	13.0
P28-8M-20-QT	20182256	1.0	P40-8M-30-SH	20182342	2.6	P72-8M-85-E	20182463	16.2
P28-8M-30-QT	20182257	1.4	P40-8M-50-SH	20182343	3.6	P80-8M-20-SDS	20182477	7.4
P28-8M-50-MPB	20182258	4.2	P40-8M-85-SKL	20182345	4.9	P80-8M-30-SK	20182478	9.8
P30-8M-20-QT	20182270	1.3	P44-8M-20-SDS	20182357	2.4	P80-8M-50-SF	20182479	13.1
P30-8M-30-QT	20182271	1.7	P44-8M-30-SDS	20182358	2.8	P80-8M-85-E	20182480	21.3
P30-8M-50-MPB	20182272	4.9	P44-8M-50-SD	20182359	4.6	P90-8M-20-SDS	20182494	7.2
P32-8M-20-QT	20182281	1.4	P44-8M-85-SFL	20182361	5.5	P90-8M-30-SK	20182495	11.5
P32-8M-30-QT	20182282	1.6	P48-8M-20-SDS	20182373	3.0	P90-8M-50-SF	20182496	16.1
P32-8M-50-MPB	20182283	5.3	P48-8M-30-SDS	20182374	3.5	P90-8M-85-E	20182497	27.7
P34-8M-20-SH	20182294	1.4	P48-8M-50-SD	20182375	5.8	P112-8M-30-SK	20182194	13.5
P34-8M-30-SH	20182295	1.6	P48-8M-85-SFL	20182377	7.5	P112-8M-50-SF	20182195	20.0
P34-8M-50-SH	20182296	2.1	P56-8M-20-SDS	20182402	4.4	P112-8M-85-F	20182196	58.0
P34-8M-85-MPB	20182298	8.4	P56-8M-30-SDS	20182403	5.0	P144-8M-50-E	20182208	31.2
P36-8M-20-SH	20182309	1.7	P56-8M-50-SK	20182404	7.4	P144-8M-85-F	20182209	52.0
P36-8M-30-SH	20182310	2.0	P56-8M-85-EL	20182405	10.1	P192-8M-50-E	20182230	51.0
P36-8M-50-SH	20182311	2.7	P64-8M-20-SDS	20182431	5.9	P192-8M-85-F	20182231	70.0

*Weight does not include bushing.

Sprockets with Minimum Plain Bore (MPB) are specified when the sprocket does not allow room for a bushing that will handle the maximum load.

Hawk Pd[®] Sprockets

Available Sizes

14mm Synchronous Sprockets

Part #	SAP #	Weight*	Part #	SAP #	Weight*	Part #	SAP #	Weight*
P28-14M-40-SK	20182252	5.2	P44-14M-85-E	20182351	21.0	P72-14M-170-J	20182449	112.2
P28-14M-55-SK	20182253	6.5	P44-14M-115-E	20182346	25.2	P80-14M-40-E	20182467	34.2
P28-14M-85-SFL	20182254	8.8	P44-14M-170-FL	20182348	39.0	P80-14M-55-F	20182468	51.5
P28-14M-115-SFL	20182250	11.3	P48-14M-40-E	20182365	19.0	P80-14M-85-F	20182469	60.6
P29-14M-40-SK	20182260	5.9	P48-14M-55-E	20182366	21.9	P80-14M-115-J	20182465	84.8
P29-14M-55-SK	20182261	7.5	P48-14M-85-E	20182367	27.6	P80-14M-170-J	20182466	103.9
P29-14M-85-SFL	20182262	10.1	P48-14M-115-E	20182362	33.2	P90-14M-40-E	20182484	34.4
P29-14M-115-SFL	20182259	13.0	P48-14M-170-FL	20182364	51.0	P90-14M-55-F	20182485	47.7
P30-14M-40-SK	20182266	5.6	P52-14M-40-E	20182380	23.1	P90-14M-85-F	20182486	58.1
P30-14M-55-SK	20182267	6.7	P52-14M-55-E	20182381	26.3	P90-14M-115-J	20182482	73.3
P30-14M-85-EL	20182268	7.8	P52-14M-85-E	20182382	32.6	P90-14M-170-J	20182483	88.2
P30-14M-115-EL	20182264	10.0	P52-14M-115-F	20182378	43.4	P112-14M-40-E	20182184	45.0
P32-14M-40-SK	20182275	7.2	P52-14M-170-F	20182379	54.2	P112-14M-55-F	20182185	61.8
P32-14M-55-SK	20182276	8.7	P56-14M-40-E	20182392	27.7	P112-14M-85-F	20182186	78.8
P32-14M-85-EL	20182277	10.7	P56-14M-55-E	20182393	31.1	P112-14M-115-J	20182182	100.5
P32-14M-115-EL	20182273	13.7	P56-14M-85-F	20182394	44.4	P112-14M-170-M	20182183	158.0
P34-14M-40-SK	20182286	8.6	P56-14M-115-F	20182390	51.3	P144-14M-40-E	20182200	72.2
P34-14M-55-SK	20182287	10.5	P56-14M-170-F	20182391	63.0	P144-14M-55-F	20182201	95.9
P34-14M-85-EL	20182288	13.6	P60-14M-40-E	20182409	32.5	P144-14M-85-F	20182202	107.9
P34-14M-115-EL	20182284	17.3	P60-14M-55-E	20182410	36.4	P144-14M-115-J	20182198	143.5
P36-14M-40-SF	20182302	7.7	P60-14M-85-F	20182411	52.4	P144-14M-170-M	20182199	233.5
P36-14M-55-SF	20182303	10.6	P60-14M-115-F	20182407	60.2	P168-14M-40-F	20182212	92.9
P36-14M-85-SF	20182304	13.9	P60-14M-170-J	20182408	76.0	P168-14M-55-F	20182213	99.8
P36-14M-115-FL	20182299	17.0	P64-14M-40-E	20182421	28.8	P168-14M-85-J	20182214	133.0
P36-14M-170-FL	20182301	23.0	P64-14M-55-F	20182422	52.2	P168-14M-115-M	20182210	215.0
P38-14M-40-SF	20182317	10.3	P64-14M-85-F	20182423	60.4	P168-14M-170-M	20182211	258.6
P38-14M-55-SF	20182318	12.2	P64-14M-115-J	20182419	73.0	P192-14M-40-F	20182222	114.0
P38-14M-85-SF	20182319	16.1	P64-14M-170-J	20182420	87.0	P192-14M-55-F	20182223	122.8
P38-14M-115-FL	20182314	21.0	P68-14M-40-E	20182438	31.1	P192-14M-85-J	20182224	162.0
P38-14M-170-FL	20182316	28.0	P68-14M-55-F	20182439	37.0	P192-14M-115-M	20182220	256.0
P40-14M-40-SF	20182333	12.1	P68-14M-85-F	20182440	53.7	P192-14M-170-M	20182221	337.0
P40-14M-55-SF	20182334	14.4	P68-14M-115-J	20182436	84.8	P216-14M-40-F	20182234	147.0
P40-14M-85-SF	20182335	19.1	P68-14M-170-J	20182437	99.3	P216-14M-55-F	20182235	158.0
P40-14M-115-FL	20182330	25.0	P72-14M-40-E	20182450	29.9	P216-14M-85-J	20182236	224.0
P40-14M-170-FL	20182332	34.0	P72-14M-55-F	20182451	47.6	P216-14M-115-M	20182233	304.0
P44-14M-40-E	20182349	14.8	P72-14M-85-F	20182452	58.2	P216-14M-170-M	20182234	405.0
P44-14M-55-E	20182350	16.9	P72-14M-115-J	20182448	96.7			

*Weight does not include bushing.

20mm Synchronous Sprockets

Part #	SAP #	Weight*	Part #	SAP #	Weight*	Part #	SAP #	Weight*
P34-20M-115-F	20182290	31.1	P60-20M-170-M	20182413	198.6	P90-20M-290-N	20182490	359.2
P34-20M-170-2½	20182291	81.4	P60-20M-230-M	20182414	217.1	P90-20M-340-P	20182491	425.4
P36-20M-115-F	20182305	39.7	P60-20M-290-N	20182415	257.2	P112-20M-115-M	20182187	238.5
P36-20M-170-2½	20182306	92.6	P60-20M-340-N	20182416	272.7	P112-20M-170-N	20182188	308.9
P38-20M-115-F	201823204	4.5	P64-20M-115-J	20182424	103.4	P112-20M-230-N	20182189	356.8
P38-20M-170-J	20182321	55.7	P64-20M-170-M	20182425	174.8	P112-20M-290-P	20182190	513.2
P38-20M-230-2½	20182322	119.9	P64-20M-230-M	20182426	198.0	P112-20M-340-P	20182191	542.9
P40-20M-115-F	20182336	50.6	P64-20M-290-N	20182427	298.9	P144-20M-115-N	20182203	340.5
P40-20M-170-J	20182337	63.8	P64-20M-340-N	20182428	315.6	P144-20M-170-N	20182204	426.2
P40-20M-230-2½	20182338	146.8	P68-20M-115-J	20182441	109.4	P144-20M-230-P	20182205	542.0
P44-20M-115-F	20182352	63.2	P68-20M-170-M	20182442	187.3	P144-20M-290-P	20182206	637.2
P44-20M-170-J	20182353	80.5	P68-20M-230-N	20182443	323.5	P144-20M-340-W	20182207	813.4
P44-20M-230-2½	20182354	179.6	P68-20M-290-N	20182444	345.5	P168-20M-115-N	20182215	417.2
P48-20M-115-J	20182368	83.6	P68-20M-340-N	20182445	375.0	P168-20M-170-P	20182216	560.0
P48-20M-170-M	20182369	113.3	P72-20M-115-J	20182453	118.7	P168-20M-230-P	20182217	635.0
P48-20M-230-M	20182370	128.9	P72-20M-170-M	20182454	195.5	P168-20M-290-W	20182218	891.2
P52-20M-115-J	20182383	79.5	P72-20M-230-N	20182455	286.9	P168-20M-340-W	20182219	947.2
P52-20M-170-M	20182384	140.6	P72-20M-290-N	20182456	310.4	P192-20M-115-N	20182225	499.9
P52-20M-230-M	20182385	158.3	P72-20M-340-N	20182457	330.2	P192-20M-170-P	20182226	680.0
P52-20M-290-N	20182386	186.2	P80-20M-115-M	20182470	181.5	P192-20M-230-W	20182227	935.1
P52-20M-340-N	20182387	201.0	P80-20M-170-M	20182471	214.1	P192-20M-290-W	20182228	1060.3
P56-20M-115-J	20182395	87.1	P80-20M-230-N	20182472	279.5	P192-20M-340-S	20182229	1367.8
P56-20M-170-M	20182396	169.7	P80-20M-290-N	20182473	313.9	P216-20M-115-N	20182237	565.7
P56-20M-230-M	20182397	188.8	P80-20M-340-P	20182474	406.3	P216-20M-170-P	20182238	812.9
P56-20M-290-N	20182398	223.2	P90-20M-115-M	20182487	211.8	P216-20M-230-W	20182239	1061.5
P56-20M-340-N	20182399	239.3	P90-20M-170-M	20182488	249.8	P216-20M-290-W	20182240	1238.9
P60-20M-115-J	20182412	93.7	P90-20M-230-N	20182489	318.4	P216-20M-340-S	20182241	1554.9

*Weight does not include bushing.

Hawk Pd[®] Taper-Lock Sprockets

Available Sizes

8mm Pitch Taper-Lock Synchronous Sprockets

Part #	SAP #	Weight*	Part #	SAP #	Weight*	Part #	SAP #	Weight*
P22-8M-20-1108	20182754	0.4	P36-8M-50-1610	20182797	2.4	P56-8M-85-2517	20182842	9.8
P22-8M-30-1108	20182755	0.5	P36-8M-85-1615	20182798	3.8	P64-8M-20-2012	20182851	7.6
P24-8M-20-1108	20182756	0.6	P38-8M-20-1610	20182803	1.8	P64-8M-30-2517	20182852	9.2
P24-8M-30-1108	20182757	0.7	P38-8M-30-1610	20182804	2.1	P64-8M-50-2517	20182853	11.2
P26-8M-20-1108	20182758	0.8	P38-8M-50-1610	20182805	2.8	P64-8M-85-2517	20182854	13.8
P26-8M-30-1108	20182759	0.9	P38-8M-85-1610	20182806	3.8	P72-8M-20-2012	20182863	10.0
P28-8M-20-1108	20182763	1.0	P40-8M-20-1610	20182811	2.1	P72-8M-30-2517	20182864	12.4
P28-8M-30-1108	20182764	1.2	P40-8M-30-2012	20182812	2.1	P72-8M-50-2517	20182865	15.1
P28-8M-50-1108	20182765	1.6	P40-8M-50-2012	20182813	2.9	P72-8M-85-3020	20182866	17.3
P30-8M-20-1210	20182773	1.0	P40-8M-85-2012	20182814	4.0	P80-8M-20-2517	20182871	13.2
P30-8M-30-1210	20182774	1.2	P44-8M-20-2012	20182819	2.6	P80-8M-30-2517	20182872	16.1
P30-8M-50-1210	20182775	1.7	P44-8M-30-2012	20182820	3.0	P80-8M-50-2517	20182873	26.0
P32-8M-20-1210	20182780	1.3	P44-8M-50-2012	20182821	3.9	P80-8M-85-3020	20182874	23.0
P32-8M-30-1210	20182781	1.5	P44-8M-85-2012	20182822	5.4	P90-8M-20-2517	20182879	12.2
P32-8M-50-1210	20182782	2.0	P48-8M-20-2012	20182827	3.5	P90-8M-30-2517	20182880	13.4
P34-8M-20-1610	20182787	1.2	P48-8M-30-2012	20182828	3.9	P90-8M-50-3020	20182881	26.0
P34-8M-30-1610	20182788	1.4	P48-8M-50-2012	20182829	5.2	P90-8M-85-3020	20182882	30.0
P34-8M-50-1610	20182789	1.9	P48-8M-85-2012	20182830	7.2	P112-8M-30-2517	20182751	28.0
P34-8M-85-1615	20182790	2.9	P56-8M-20-2012	20182839	5.4	P112-8M-50-3020	20182752	27.0
P36-8M-20-1610	20182795	1.5	P56-8M-30-2012	20182840	6.1	P112-8M-85-3020	20182753	35.0
P36-8M-30-1610	20182796	1.7	P56-8M-50-2517	20182841	7.6			

*Weight does not include bushing.

14mm Pitch Taper-Lock Synchronous Sprockets

Part #	SAP #	Weight*	Part #	SAP #	Weight*	Part #	SAP #	Weight*
P28-14M-40-2012	20182760	5.2	P38-14M-115-3020	20182799	19.2	P64-14M-40-3020	20182848	29.0
P28-14M-55-2012	20182761	6.4	P40-14M-40-2517	20182808	13.3	P64-14M-55-3020	20182849	34.0
P28-14M-85-2012	20182762	9.0	P40-14M-55-2517	20182809	15.6	P64-14M-85-3535	20182850	71.0
P29-14M-40-2012	20182766	5.9	P40-14M-85-3020	20182810	18.5	P64-14M-115-4545	20182847	80.0
P29-14M-55-2012	20182767	7.4	P40-14M-115-3020	20182807	23.0	P68-14M-40-3020	20182856	31.0
P29-14M-85-2012	20182768	10.3	P44-14M-40-2517	20182816	16.6	P68-14M-55-3020	20182857	37.0
P30-14M-40-2012	20182770	5.8	P44-14M-55-2517	20182817	18.7	P68-14M-85-3535	20182858	83.0
P30-14M-55-2517	20182771	6.5	P44-14M-85-3020	20182818	22.0	P68-14M-115-4545	20182855	94.0
P30-14M-85-2517	20182772	8.7	P44-14M-115-3535	20182815	28.0	P72-14M-40-3020	20182860	34.0
P30-14M-115-2517	20182769	11.0	P48-14M-40-2517	20182824	21.0	P72-14M-55-3020	20182861	41.0
P32-14M-40-2012	20182777	7.4	P48-14M-55-3020	20182825	23.0	P72-14M-85-3535	20182862	70.0
P32-14M-55-2517	20182778	8.5	P48-14M-85-3020	20182826	29.0	P72-14M-115-4545	20182859	109.0
P32-14M-85-2517	20182779	11.6	P48-14M-115-3535	20182823	38.0	P80-14M-40-3020	20182868	35.0
P32-14M-115-2517	20182776	14.8	P52-14M-40-2517	20182832	26.0	P80-14M-55-3020	20182869	43.0
P34-14M-40-2012	20182784	8.7	P52-14M-55-3020	20182833	28.0	P80-14M-85-3535	20182870	74.0
P34-14M-55-2517	20182785	10.3	P52-14M-85-3535	20182834	41.0	P80-14M-115-4545	20182867	143.0
P34-14M-85-2517	20182786	14.1	P52-14M-115-4040	20182831	45.0	P90-14M-40-3020	20182876	36.0
P34-14M-115-2517	20182783	17.8	P56-14M-40-2517	20182836	21.0	P90-14M-55-3020	20182877	40.0
P36-14M-40-2517	20182792	9.7	P56-14M-55-3020	20182837	34.0	P90-14M-85-3535	20182878	72.0
P36-14M-55-2517	20182793	11.2	P56-14M-85-3535	20182838	51.0	P90-14M-115-4545	20182875	127.0
P36-14M-85-3020	20182794	12.3	P56-14M-115-4040	20182835	56.0	P112-14M-40-3020	20182748	47.0
P36-14M-115-3020	20182791	15.4	P60-14M-40-3020	20182844	27.0	P112-14M-55-3020	20182749	55.0
P38-14M-40-2517	20182800	11.5	P60-14M-55-3020	20182845	40.0	P112-14M-85-3535	20182750	89.0
P38-14M-55-2517	20182801	13.4	P60-14M-85-3535	20182846	61.0	P112-14M-115-4545	20182747	136.0
P38-14M-85-3020	20182802	15.4	P60-14M-115-4040	20182843	68.0			

*Weight does not include bushing.

Blackhawk Pd® Belts

A high-performance synchronous belt with a universal profile

For a curvilinear belt that offers improved performance in your synchronous application, look no further than Blackhawk Pd®. The high-performance belt offers best-of-breed technology and higher horsepower for the money. Its proven durability and strength make it a compatible upgrade for many other timing belts.



Part Number: 480 8M BH 12

480	480mm pitch length
8M	8mm pitch
BH	Blackhawk® belt
12	12mm wide

Belt materials that last longer

Blackhawk Pd® belts feature a patented high-grade rubber compound. This cross-linked elastomer is formulated to resist tooth deformity and increase tooth rigidity, increasing belt life and decreasing replacement costs.

Blackhawk Pd®'s aramid tensile members provide excellent dimensional stability and high impact strength. Blackhawk Pd® requires virtually no retensioning and minimum maintenance.

The demands of synchronous drives put additional strain on the belt and tooth surface for high-speed and low-speed applications. The Blackhawk Pd® tooth profile resists ratcheting and provides accurate positioning for synchronous drive applications.

High-capacity performance

Blackhawk Pd® synchronous belts are designed for high-capacity performance, exceeding the traditional speed limitations of chain and performance limitations of belt drives. Blackhawk Pd® belts are able to perform in drives ranging from fractional horsepower to 400 horsepower. The new material technology delivers a higher horsepower rating.

Lower maintenance costs

Unlike chain drives, Blackhawk Pd® belts and matching sprockets do not require lubrication. There is virtually no need for retensioning like there is for V-belt and chain drives. Install Blackhawk Pd® and watch your maintenance costs drop to practically nothing.

Applications

Nearly every conceivable industrial drive application where precise shaft synchronization is required. Blackhawk Pd® belts can also be used as an alternative to problem V-belt and chain drives.

- > Aggregate machinery
- > Paper industry machinery
- > Printing trade machinery
- > Food processing equipment
- > Packaging machinery
- > Mining equipment
- > Woodworking machinery
- > Office equipment
- > Machine tool
- > Home appliances
- > HVAC units
- > Textile machinery
- > Farm machinery
- > Vending machines

Key features & benefits

- > Universal tooth profile drops into existing HTD® and RPP sprockets.
- > High-grade Hibrex® compound.
- > Aramid tensile members provide excellent dimensional stability and high-impact strength.
- > Requires little, if any, retensioning and less drive maintenance.
- > Oil, heat, ozone and abrasion resistant.
- > Designed for high-capacity performance.
- > Higher horsepower rating than traditional timing belts.
- > Static conductive.*

To learn more, visit www.contitech.us.

*Drive conditions and service variables in combination with time in operation can result in a loss of static conductivity. It is recommended that a conductivity check be added to drive preventive maintenance programs where belt static conductivity is a requirement.

Available Sizes

In addition to our stock lineup of synchronous belts, we can manufacture additional sizes (lengths) not listed.

For full product availability and specifications, please visit www.contitech.us or contact a Sales Representative.

8m
8mm pitch

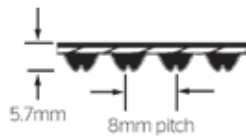

Pitch Length (mm)	Pitch Length (mm)	Pitch Length (mm)
480	1040	2000
560	1120	2400
600	1200	2600
640	1280	2800
720	1440	3048
800	1600	3280
880	1760	3600
960	1800	4400

Stock Widths: 12mm, 22mm, 35mm, 60mm

14m
14mm pitch

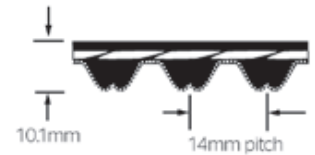

Pitch Length (mm)	Pitch Length (mm)	Pitch Length (mm)
966	2450	4578
1190	2590	4956
1400	2800	5320
1610	3150	5740
1778	3360	6160
1890	3500	6860
2100	3850	
2310	4326	

Stock Widths: 20mm, 42mm, 65mm, 90mm, 120mm

Blackhawk Pd[®] Sprockets

Available Sizes

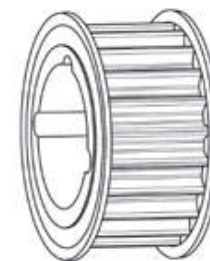

Part Number: W38-14M-20-SF

W38 38 grooves/teeth
14 14mm pitch length
20 20mm width
SF QD[®] bushing

8mm Synchronous Blackhawk Pd[®] Sprockets

Part #	SAP #	Weight*	Part #	SAP #	Weight*	Part #	SAP #	Weight*
W22-8M-12-MPB	20182589	0.9	W34-8M-60-MPB	20182641	6.6	W64-8M-35-SK	20182713	8.8
W22-8M-22-MPB	20182590	1.2	W36-8M-12-SH	20182647	1.3	W64-8M-60-SF	20182714	10.2
W22-8M-35-MPB	20182591	1.6	W36-8M-22-SH	20182648	1.6	W72-8M-12-SDS	20182725	5.1
W22-8M-60-MPB	20182592	2.3	W36-8M-35-SH	20182649	2.0	W72-8M-22-SDS	20182726	6.0
W24-8M-12-JA	20182593	0.5	W36-8M-60-SKL	20182650	2.4	W72-8M-35-SK	20182727	11.6
W24-8M-22-JA	20182594	0.7	W38-8M-12-SH	20182656	1.6	W72-8M-60-E	20182728	14.0
W24-8M-35-MPB	20182595	2.0	W38-8M-22-SH	20182657	1.9	W80-8M-12-SDS	20182734	6.7
W24-8M-60-MPB	20182596	2.7	W38-8M-35-SH	20182658	2.3	W80-8M-22-SDS	20182735	7.8
W26-8M-12-JA	20182597	0.6	W38-8M-60-SKL	20182659	3.0	W80-8M-35-SF	20182736	11.3
W26-8M-22-JA	20182598	0.7	W40-8M-12-SH	20182665	1.9	W80-8M-60-E	20182737	18.5
W26-8M-35-MPB	20182599	2.4	W40-8M-22-SH	20182666	2.3	W90-8M-12-SDS	20182743	6.3
W26-8M-60-MPB	20182600	3.3	W40-8M-35-SH	20182667	2.8	W90-8M-22-SDS	20182744	7.5
W28-8M-12-QT	20182606	0.7	W40-8M-60-SKL	20182668	3.8	W90-8M-35-SF	20182745	14.0
W28-8M-22-QT	20182607	1.1	W44-8M-12-SDS	20182674	2.1	W90-8M-60-E	20182746	24.5
W28-8M-35-QT	20182608	1.5	W44-8M-22-SDS	20182675	2.5	W112-8M-12-SK	20182557	10.6
W28-8M-60-MPB	20182609	4.0	W44-8M-35-SD	20182676	3.8	W112-8M-22-SK	20182558	12.0
W30-8M-12-QT	20182620	0.9	W44-8M-60-SFL	20182677	4.4	W112-8M-35-SF	20182559	17.2
W30-8M-22-QT	20182621	1.3	W48-8M-12-SDS	20182683	2.6	W112-8M-60-F	20182560	53.3
W30-8M-35-QT	20182622	1.8	W48-8M-22-SDS	20182684	3.2	W144-8M-12-SK	20182566	18.5
W30-8M-60-MPB	20182623	4.8	W48-8M-35-SD	20182685	4.9	W144-8M-22-SK	20182567	20.7
W32-8M-12-QT	20182629	1.1	W48-8M-60-SFL	20182686	6.1	W144-8M-35-E	20182568	27.5
W32-8M-22-QT	20182630	1.4	W56-8M-12-SDS	20182697	3.9	W144-8M-60-F	20182569	45.3
W32-8M-35-QT	20182631	1.6	W56-8M-22-SDS	20182698	4.5	W192-8M-12-SF	20182580	27.5
W32-8M-60-MPB	20182632	5.7	W56-8M-35-SK	20182699	6.2	W192-8M-22-SF	20182581	30.6
W34-8M-12-SH	20182638	1.2	W56-8M-60-EL	20182700	8.4	W192-8M-35-E	20182582	46.2
W34-8M-22-SH	20182639	1.3	W64-8M-12-SDS	20182711	5.3	W192-8M-60-F	20182583	62.0
W34-8M-35-SH	20182640	1.6	W64-8M-22-SDS	20182712	6.1			

*Weight does not include bushing.

Sprockets with Minimum Plain Bore (MPB) are specified when the sprocket does not allow room for a bushing that will handle the maximum load.

14mm Synchronous Blackhawk Pd® Sprockets

Part #	SAP #	Weight*	Part #	SAP #	Weight*	Part #	SAP #	Weight*
W28-14M-20-SK	20182602	3.2	W40-14M-120-FL	20182660	31.9	W72-14M-90-F	20182724	61.6
W28-14M-42-SK	20182603	5.1	W44-14M-20-E	20182670	12.0	W72-14M-120-J	20182720	96.0
W28-14M-65-SFL	20182604	6.7	W44-14M-42-E	20182671	14.6	W80-14M-20-E	20182730	28.0
W28-14M-90-MPB	20182605	18.9	W44-14M-65-E	20182672	17.7	W80-14M-42-E	20182731	34.0
W28-14M-120-MPB	20182601	21.0	W44-14M-90-FL	20182673	27.0	W80-14M-65-F	20182732	53.0
W29-14M-20-SK	20182611	3.6	W44-14M-120-FL	20182669	31.9	W80-14M-90-J	20182733	74.7
W29-14M-42-SK	20182612	6.2	W48-14M-20-E	20182679	14.7	W80-14M-120-J	20182729	84.0
W29-14M-65-SFL	20182613	7.2	W48-14M-42-E	20182680	18.8	W90-14M-20-E	20182739	29.4
W29-14M-90-MPB	20182614	20.2	W48-14M-65-E	20182681	23.0	W90-14M-42-F	20182740	43.6
W29-14M-120-MPB	20182610	22.0	W48-14M-90-FL	20182682	36.0	W90-14M-65-F	20182741	52.3
W30-14M-20-SK	20182616	4.0	W48-14M-120-FL	20182678	41.3	W90-14M-90-J	20182742	67.0
W30-14M-42-SK	20182617	5.5	W52-14M-20-E	20182688	17.6	W90-14M-120-M	20182738	149.0
W30-14M-65-EL	20182618	5.7	W52-14M-42-E	20182689	23.0	W112-14M-20-E	20182553	39.1
W30-14M-90-EL	20182619	7.4	W52-14M-65-E	20182690	28.0	W112-14M-42-F	20182554	76.9
W30-14M-120-EL	20182615	9.2	W52-14M-90-F	20182691	37.0	W112-14M-65-J	20182555	82.6
W32-14M-20-SK	20182625	4.9	W52-14M-120-F	20182687	43.0	W112-14M-90-J	20182556	90.6
W32-14M-42-SK	20182626	7.0	W56-14M-20-E	20182693	21.0	W112-14M-120-M	20182552	147.0
W32-14M-65-EL	20182627	7.6	W56-14M-42-E	20182694	27.4	W144-14M-20-E	20182562	63.3
W32-14M-90-EL	20182628	10.0	W56-14M-65-F	20182695	39.0	W144-14M-42-F	20182563	111.0
W32-14M-120-EL	20182624	12.8	W56-14M-90-F	20182696	44.0	W144-14M-65-M	20182564	189.0
W34-14M-20-SK	20182634	5.8	W56-14M-120-F	20182692	51.1	W144-14M-90-M	20182565	199.0
W34-14M-42-SF	20182635	7.4	W60-14M-20-E	20182702	25.2	W144-14M-120-M	20182561	214.0
W34-14M-65-EL	20182636	10.0	W60-14M-42-E	20182703	32.2	W168-14M-20-F	20182571	131.0
W34-14M-90-EL	20182637	13.2	W60-14M-65-F	20182704	46.0	W168-14M-42-F	20182572	138.0
W34-14M-120-FL	20182633	14.4	W60-14M-90-F	20182705	53.0	W168-14M-65-M	20182573	196.0
W36-14M-20-SF	20182643	6.4	W60-14M-120-F	20182701	59.8	W168-14M-90-M	20182574	235.0
W36-14M-42-SF	20182644	8.5	W64-14M-20-E	20182707	23.0	W168-14M-120-M	20182570	273.0
W36-14M-65-FL	20182645	11.4	W64-14M-42-E	20182708	28.0	W192-14M-20-J	20182576	146.0
W36-14M-90-FL	20182646	13.8	W64-14M-65-F	20182709	53.7	W192-14M-42-J	20182577	157.0
W36-14M-120-FL	20182642	17.0	W64-14M-90-F	20182710	60.1	W192-14M-65-M	20182578	264.0
W38-14M-20-SF	20182652	7.5	W64-14M-120-J	20182706	73.0	W192-14M-90-M	20182579	279.0
W38-14M-42-SF	20182653	10.2	W68-14M-20-E	20182716	25.2	W192-14M-120-N	20182575	365.0
W38-14M-65-FL	20182654	14.1	W68-14M-42-E	20182717	31.2	W216-14M-20-J	20182585	171.0
W38-14M-90-FL	20182655	17.4	W68-14M-65-F	20182718	46.8	W216-14M-42-J	20182586	186.0
W38-14M-120-FL	20182651	21.5	W68-14M-90-F	20182719	55.0	W216-14M-65-M	20182587	303.0
W40-14M-20-SF	20182661	8.6	W68-14M-120-J	20182715	84.0	W216-14M-90-M	20182588	377.0
W40-14M-42-SF	20182662	11.9	W72-14M-20-E	20182721	24.4	W216-14M-120-N	20182584	423.0
W40-14M-65-FL	20182663	17.8	W72-14M-42-E	20182722	30.2			
W40-14M-90-FL	20182664	21.6	W72-14M-65-F	20182723	51.1			

*Weight does not include bushing.
Sprockets with Minimum Plain Bore (MPB) are specified when the sprocket does not allow room for a bushing that will handle the maximum load.

Positive Drive Pd[®] Belts

Speed, accuracy and dependability for precision-engineered drives

Continental ContiTech Positive Drive belts give you the opportunity to design your drives for the speed, accuracy and dependability consistent with the best synchronous belt drives, all without the bulk, weight and added cost that is inherent in chain and gear power transmission systems.

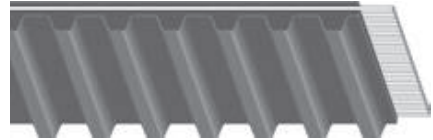

Part Number: 100 XL 025

100	10.0 in. pitch length
XL	Pitch-trapezoidal tooth profile
025	.25 in. wide

Continental ContiTech Pd[®] belts have precision-molded teeth to deliver the synchronized power you need. Because they are made of specially compounded rubber, reinforced with high-strength, stable fiberglass tensile cord members and have a long-wearing nylon facing, they are durable and provide a smooth, precise operation.

Engineered for full-power transmission, smooth operation

Our Positive Drive belts are made with world-class rubber technology which is specifically compounded to resist damaging environmental factors that can shorten belt life. Our specialized compound technology has excellent oil, heat and ozone resistance, increasing durability and preserving belt flexibility leading to extended belt life.

Available in a variety of pitches

Continental ContiTech Pd[®] belts are available in a variety of pitches depending on the application.

Applications

Nearly every conceivable industrial drive application where precise shaft synchronization is required. Positive Drive belts can also be used as an alternative to problem V-belt and chain drives.

- > Aggregate machinery
- > Chain drives
- > Packaging machinery
- > Paper industry machinery
- > Food processing equipment
- > Printing trade machinery
- > Woodworking machinery
- > Office equipment
- > Machine tools
- > Farm machinery
- > Home appliances
- > Textile machinery
- > Mining equipment

Key features & benefits

- > Universal trapezoidal tooth profiles drop into existing sprockets.
- > High-grade compounding.
- > Fiberglass tension cords for excellent resistance to shrinkage/elongation.
- > Oil, heat, ozone and abrasion resistant.
- > Low-maintenance/high-efficiency rating.

Positive Drive Pd[®] Belts

Available Sizes

13 inch wide Pd[®] sleeves are available from stock in XL, L, H, XH and XXH profiles.

For nonstock sizes, contact your Power Transmission Products (PTP) Industrial Distributor. Please consult your PTP List Prices Pages publications for the full range of sizes.

MXL (Mini Extra Light)

For small business machines, office equipment, electric equipment, etc.

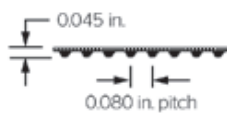

Standard Part Numbers

13/16 in. Pitch

40MXL	72MXL	112MXL
44MXL	80MXL	120MXL
48MXL	88MXL	140MXL
64MXL	96MXL	168MXL

Stock Widths:* 1/8 in.=012, 3/16 in.=019, 1/4 in.=025

XL (Extra Light)

For business machines, instruments, sound equipment, etc.

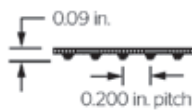

Standard Part Numbers

1/5 in. Pitch

50XL	190XL	350XL
60XL	200XL	370XL
70XL	210XL	380XL
80XL	220XL	390XL
90XL	230XL	400XL
100XL	240XL	420XL
110XL	250XL	450XL
120XL	260XL	460XL
130XL	280XL	480XL
140XL	290XL	500XL
150XL	300XL	570XL
160XL	310XL	630XL
170XL	330XL	770XL
180XL	340XL	

Stock Widths:* 1/4 in.=025, 3/8 in.=037

L (Light)

For fraction power-rated motor applications such as in-home appliances, small tools, pumps, blowers, etc.

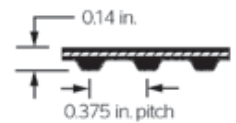

Standard Part Numbers

3/8 in. Pitch

124L	255L	450L
135L	270L	480L
150L	285L	510L
165L	300L	540L
187L	322L	600L
195L	345L	660L
210L	367L	817L
225L	390L	900L
240L	420L	

Stock Widths:* 1/2 in.=050, 3/4 in.=075, 1 in.=100

*Stock Widths: Use the three-digit size number as a suffix to the belt number when ordering.

Positive Drive Pd® Belts

Available Sizes (continued)

13 inch wide Pd® sleeves are available from stock in XL, L, H, XH and XXH profiles.

For nonstock sizes, contact your PTP Industrial Distributor. Please consult your PTP List Prices Pages publications for the full range of sizes.

H (Heavy)

For machine tools, pumps, fans, presses, motor generator sets, etc.

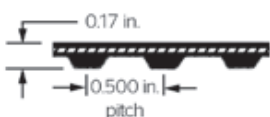

XH** (Extra Heavy)

For medium torque applications on heavy industrial equipment.



Standard Part Numbers

1/2 in. Pitch

210H	480H	780H
220H	490H	800H
230H	510H	820H
240H	540H	850H
270H	560H	900H
300H	570H	960H
320H	585H	1000H
330H	600H	1100H
360H	630H	1250H
390H	645H	1400H
400H	660H	1700H
410H	700H	
420H	730H	
450H	750H	

Stock Widths:* 3/4 in.=075, 1 in.=100, 1 1/2 in.=150, 2 in.=200, 3 in.=300

Standard Part Numbers

7/8 in. Pitch

507XH	770XH	1260XH
560XH	840XH	1400XH
630XH	980XH	1540XH
700XH	1120XH	1750XH

Stock Widths:* 2 in.=200, 3 in.=300, 4 in.=400

XXH** (Double Extra Heavy)

For high torque applications on heavy industrial equipment.

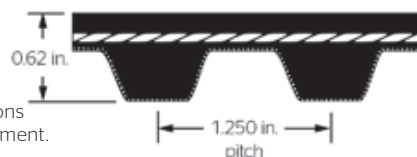

Standard Part Numbers

1 1/4 in. Pitch

700XXH	1000XXH	1600XXH
800XXH	1200XXH	
900XXH	1400XXH	

Stock Widths:* 2 in.=200, 3 in.=300, 4 in.=400, 5 in.=500

*Stock Widths: Use the three-digit size number as a suffix to the belt number when ordering.

**Drive conditions and service variables in combination with time in operation can result in a loss of static conductivity. It is recommended that a conductivity check be added to drive preventive maintenance programs where belt static conductivity is a requirement.

Positive Drive Pd[®] Sprockets

Available Sizes

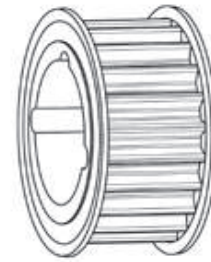

Part Number: 20L050-JA

- 20 20 teeth
- L Pitch-trapezoidal tooth profile
- 050 0.50mm or in. width
- JA Bushing

XL Synchronous (Timing) Sprockets

Part #	SAP #	Weight*	Part #	SAP #	Weight*	Part #	SAP #	Weight*
10XL037-MPB	20178894	0.03	21XL037-MPB	20181963	0.19	40XL037-MPB**	20182075	0.31
11XL037-MPB	20178895	0.03	22XL037-MPB	20181974	0.22	42XL037-MPB**	20182091	0.31
12XL037-MPB	20181888	0.06	24XL037-MPB	20181990	0.25	44XL037-MPB**	20182094	0.31
14XL037-MPB	20181896	0.06	28XL037-MPB	20182022	0.34	48XL037-MPB**	20182104	0.38
15XL037-MPB	20181901	0.09	30XL037-MPB	20182035	0.41	60XL037-MPB**	20182119	0.38
16XL037-MPB	20181909	0.09	32XL037-MPB	20395679	0.20	72XL037-MPB**	20182134	0.50
18XL037-MPB	20181927	0.13	32XL037-MPB**	20182041	0.22			
20XL037-MPB	20181950	0.19	36XL037-MPB**	20182060	0.30			

*Weight does not include bushing.

Sprockets with Minimum Plain Bore (MPB) are specified when the sprocket does not allow room for a bushing that will handle the maximum load.

**Aluminum

Positive Drive Pd[®] Sprockets

Available Sizes (continued)

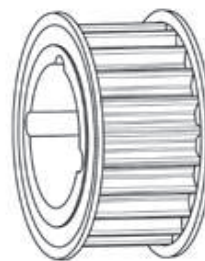

Part Number: 20L050-JA

20 20 teeth
L Pitch-trapezoidal tooth profile
050 0.50mm or in. width
JA Bushing

L Synchronous (Timing) Sprockets

Part #	SAP #	Weight*	Part #	SAP #	Weight*	Part #	SAP #	Weight*
10L050-MPB	20178893	0.2	22L050-JA	20181968	0.8	40L100-SDS	20182082	3.4
12L050-MPB	20181886	0.3	22L075-JA	20181969	0.8	44L050-SDS	20182099	3.1
12L075-MPB	20181887	0.4	22L100-JA	20181970	0.9	44L075-SDS	20182100	3.5
14L050-MPB	20181893	0.5	24L050-SH	20181984	0.5	44L100-SDS	20182101	3.9
14L075-MPB	20181894	0.6	24L075-SH	20181985	0.7	48L050-SDS	20182109	4.2
14L100-MPB	20181895	0.7	24L100-SH	20181986	0.9	48L075-SDS	20182110	4.6
16L050-MPB	20181906	0.7	26L050-MPB	20182000	2.3	48L100-SDS	20182111	5.1
16L075-MPB	20181907	0.8	26L050-SH	20182001	0.9	60L050-SD	20182124	5.6
16L100-MPB	20181908	1.0	26L075-SH	20182002	1.1	60L075-SD	20182125	6.1
17L050-MPB	20181910	0.8	26L100-SH	20182003	1.2	60L100-SD	20182126	6.7
17L075-MPB	20181911	1.0	28L050-SH	20182016	1.1	72L050-SD	20182139	6.7
17L100-MPB	20181912	1.1	28L075-SH	20182017	1.3	72L075-SD	20182140	7.6
18L050-JA	20181917	0.4	28L100-SH	20182018	1.6	72L100-SD	20182141	7.5
18L075-JA	20181918	0.5	30L050-SDS	20182029	1.2	84L050-SD	20182153	7.9
18L100-JA	20181919	0.6	30L075-SDS	20182030	1.5	84L075-SD	20182154	8.7
19L050-MPB	20181936	1.0	30L100-SDS	20182031	1.8	84L100-SD	20182155	9.6
19L075-MPB	20181937	1.2	32L050-SDS	20182047	1.5	96L050-SD	20182167	9.6
19L100-MPB	20181938	1.4	32L075-SDS	20182048	1.7	96L075-SD	20182168	10.6
20L050-JA	20181944	0.6	32L100-SDS	20182049	1.9	96L100-SD	20182169	11.6
20L075-JA	20181945	0.7	36L050-SDS	20182065	2.0	120L050-SD	20181880	12.5
20L100-JA	20181946	0.9	36L075-SDS	20182066	2.3	120L075-SD	20181881	13.7
21L050-MPB	20181960	1.3	36L100-SDS	20182067	2.6	120L100-SD	20181882	15.0
21L075-MPB	20181961	1.5	40L050-SDS	20182080	2.6			
21L100-MPB	20181962	1.8	40L075-SDS	20182081	3.0			

*Weight does not include bushing.

Sprockets with Minimum Plain Bore (MPB) are specified when the sprocket does not allow room for a bushing that will handle the maximum load.

H Synchronous (Timing) Sprockets

Part #	SAP #	Weight*	Part #	SAP #	Weight*	Part #	SAP #	Weight*
14H100-MPB	20181889	1.4	26H100-SDS	20181996	2.4	43H100-SK	20182093	10.0
14H100-JA	20181890	0.7	26H150-SD	20181997	3.6	44H100-SK	20182095	9.9
14H150-JA	20181891	1.0	26H200-SD	20181998	3.9	44H150-SK	20182096	10.8
14H200-JA	20181892	1.2	26H300-SD	20181999	4.7	44H200-SK	20182097	12.1
16H100-JA	20181902	0.8	27H100-SDS	20182011	2.7	44H300-SK	20182098	14.7
16H150-JA	20181903	0.8	28H100-SDS	20182012	3.0	45H100-SK	20182102	11.2
16H200-JA	20181904	1.3	28H150-SD	20182013	4.5	46H100-SK	20182103	11.8
16H300-MPB	20181905	4.1	28H200-SD	20182014	5.1	48H100-SK	20182105	9.1
18H100-SH	20181913	1.0	28H300-SD	20182015	6.4	48H150-SK	20182106	10.5
18H150-SH	20181914	1.4	29H100-SDS	20182023	3.3	48H200-SF	20182107	14.0
18H200-SH	20181915	1.7	30H100-SD	20182025	4.6	48H300-SF	20182108	16.9
18H300-MPB	20181916	5.4	30H150-SD	20182026	5.3	60H100-SF	20182120	11.1
19H100-MPB	20181932	3.0	30H200-SD	20182027	6.0	60H150-SF	20182121	12.8
19H150-MPB	20181933	3.7	30H300-SD	20182028	7.6	60H200-SF	20182122	15.9
19H200-MPB	20181934	4.6	31H100-SD	20182040	4.9	60H300-SF	20182123	20.0
19H300-MPB	20181935	6.2	32H100-SK	20182043	4.1	72H100-SF	20182135	16.9
20H100-MPB	20181939	3.4	32H150-SK	20182044	5.2	72H150-SF	20182136	18.9
20H100-SH	20181940	1.4	32H200-SK	20182045	5.8	72H200-SF	20182137	19.9
20H150-SH	20181941	1.8	32H300-SK	20182046	7.6	72H300-SF	20182138	24.0
20H200-SH	20181942	2.2	33H100-SK	20182053	5.0	84H100-SF	20182149	21.0
20H300-MPB	20181943	7.0	34H100-SK	20182054	5.4	84H150-SF	20182150	23.0
21H100-SH	20181956	1.5	35H100-SK	20182059	5.9	84H200-SF	20182151	27.0
21H150-MPB	20181957	4.8	36H100-SK	20182061	5.8	84H300-SF	20182152	32.0
21H200-MPB	20181958	5.6	36H150-SK	20182062	6.6	96H100-SF	20182163	25.0
21H300-MPB	20181959	7.5	36H200-SK	20182063	7.6	96H150-SF	20182164	28.0
22H100-SDS	20181964	1.5	36H300-SK	20182064	9.6	96H200-E	20182165	35.0
22H150-SD	20181965	2.2	37H100-SK	20182071	6.8	96H300-E	20182166	42.0
22H200-SD	20181966	2.7	38H100-SK	20182073	7.3	120H100-SF	20178896	31.0
22H300-SD	20181967	3.6	39H100-SK	20182074	7.8	120H150-SF	20178897	36.0
23H100-SDS	20181979	1.7	40H100-SK	20182076	8.4	120H200-E	20178898	47.0
24H100-SDS	20181980	1.9	40H150-SK	20182077	9.1	120H300-E	20178899	55.0
24H150-SD	20181981	2.8	40H200-SK	20182078	10.2	156H100-SF	20181897	45.8
24H200-SD	20181982	3.3	40H300-SK	20182079	12.3	156H150-SF	20181898	52.0
24H300-SD	20181983	4.3	41H100-SK	20182090	8.9	156H200-E	20181899	68.0
25H100-SDS	20181995	2.1	42H100-SK	20182092	9.4	156H300-E	20181900	79.0

*Weight does not include bushing.
Sprockets with Minimum Plain Bore (MPB) are specified when the sprocket does not allow room for a bushing that will handle the maximum load.

Positive Drive Pd[®] Sprockets

Available Sizes (continued)

XH Synchronous (Timing) Sprockets

Part #	SAP #	Weight*	Part #	SAP #	Weight*	Part #	SAP #	Weight*
18XH200-SK	20181920	6.8	28XH300-E	20182020	20.0	8XH400-J	20182114	65.0
18XH300-SK	20181921	9.4	28XH400-E	20182021	23.9	60XH200-F	20182127	48.0
18XH400-MPB	20181925	19.2	30XH200-E	20182032	20.8	60XH300-F	20182128	59.9
20XH200-SK	20181947	7.9	30XH300-E	20182033	25.6	0XH400-J	20182129	78.0
20XH300-SK	20181948	10.2	30XH400-E	20182034	30.0	72XH200-F	20182142	59.7
20XH400-SK	20181949	12.5	32XH200-E	20182050	24.0	72XH300-J	20182143	78.8
22XH200-SK	20181971	10.7	32XH300-E	20182051	30.0	72XH400-J	20182144	93.0
22XH300-SK	20181972	13.9	32XH400-E	20182052	35.0	84XH200-F	20182156	68.7
22XH400-SK	20181973	16.5	36XH200-E	20182068	27.0	84XH300-J	20182157	92.0
24XH200-SF	20181987	12.3	36XH300-E	20182069	33.0	84XH400-J	20182158	107.0
24XH300-SF	20181988	16.0	36XH400-E	20182070	39.0	96XH200-F	20182170	83.7
24XH400-SF	20181989	19.2	40XH200-F	20182083	40.0	96XH300-J	20182171	106.0
26XH200-SF	20182004	14.7	40XH300-F	20182084	52.7	96XH400-J	20182172	129.8
26XH300-SF	20182005	16.7	40XH400-F	20182085	57.8	120XH200-F	20181883	107.9
26XH400-SF	20182006	22.7	8XH200-F	20182112	49.0	120XH300-J	20181884	142.9
28XH200-E	20182019	16.9	48XH300-F	20182113	57.0	120XH400-J	20181885	165.5

*Weight does not include bushing.

Sprockets with Minimum Plain Bore (MPB) are specified when the sprocket does not allow room for a bushing that will handle the maximum load.

XXH Synchronous (Timing) Sprockets

Part #	SAP #	Weight*	Part #	SAP #	Weight*	Part #	SAP #	Weight*
18XXH200-SK	20181928	16.1	26XXH200-E	20182007	35.1	8XXH200-J	20182115	73.0
18XXH300-SF	20181929	19.6	6XXH300-E	20182008	43.3	48XXH300-J	20182116	90.0
18XXH400-SF	20181930	24.0	6XXH400-F	20182009	57.2	48XXH400-J	20182117	104.0
8XXH500-MPB	20181931	48.6	26XXH500-F	20182010	61.0	48XXH500-M	20182118	154.0
20XXH200-SK	20181951	19.8	30XXH200-F	20182036	48.0	60XXH200-J	20182130	93.0
20XXH300-SF	20181952	25.2	30XXH300-F	20182037	64.6	60XXH300-J	20182131	112.0
20XXH400-SF	20181953	31.1	30XXH400-F	20182038	67.0	60XXH400-M	20182132	169.0
20XXH500-MPB	20181954	61.0	30XXH500-J	20182039	93.0	60XXH500-M	20182133	195.0
2XXH200-E	20181975	23.8	34XXH200-F	20182055	57.0	72XXH200-J	20182145	111.0
22XXH300-E	20181976	30.0	34XXH300-F	20182056	68.0	72XXH300-J	20182146	142.0
22XXH400-E	20181977	36.2	34XXH400-J	20182057	86.0	72XXH400-M	20182147	224.0
22XXH500-E	20181978	42.5	34XXH500-J	20182058	97.0	72XXH500-M	20182148	231.9
24XXH200-E	20181991	29.5	40XXH200-F	20182086	60.0	90XXH200-J	20182159	140.9
24XXH300-E	20181992	36.9	40XXH300-F	20182087	75.8	90XXH300-J	20182160	192.8
24XXH400-E	20181993	44.4	40XXH400-J	20182088	96.0	90XXH400-M	20182161	259.0
24XXH500-F	20181994	56.0	40XXH500-J	20182089	110.0	90XXH500-M	20182162	314.0

*Weight does not include bushing.
Sprockets with Minimum Plain Bore (MPB) are specified when the sprocket does not allow room for a bushing that will handle the maximum load.

Positive Drive Pd[®] Sprockets

Available Sizes

L Taper-Lock Timing Sprockets

Part #	SAP #	Weight*	Part #	SAP #	Weight*	Part #	SAP #	Weight*
TL18L050 1008	20182508	0.5	TL22L100 1008	20182524	1.3	TL28L075 1610	20182544	1.2
TL18L075 1008	20182509	0.5	TL24L050 1210	20182529	1.0	TL28L100 1610	20182545	1.7
TL18L100 1008	20182510	0.7	TL24L075 1210	20182530	1.0	TL30L050 1610	20182546	1.5
TL20L050 1008	20182515	0.7	TL24L100 1210	20182531	1.3	TL30L075 1610	20182547	1.5
TL20L075 1008	20182516	0.7	TL26L050 1210	20182536	1.2	TL30L100 1610	20182548	2.2
TL20L100 1008	20182517	1.0	TL26L075 1210	20182537	1.2	TL32L050 1610	20182549	1.9
TL22L050 1008	20182522	0.9	TL26L100 1210	20182538	1.7	TL32L075 1610	20182550	1.9
TL22L075 1008	20182523	0.9	TL28L050 1210	20182543	1.2	TL32L100 1610	20182551	2.7

*Weight does not include bushing.

H Taper-Lock Timing Sprockets

Part #	SAP #	Weight*	Part #	SAP #	Weight*	Part #	SAP #	Weight*
TL14H100 1008	20182499	0.8	TL20H150 1215	20182512	2.3	TL24H300 2012	20182528	4.5
TL14H150 1008	20182500	1.0	TL20H200 1215	20182513	2.7	TL26H100 2012	20182532	2.4
TL16H100 1008	20182501	1.3	TL20H300 1215	20182514	4.0	TL26H150 2012	20182533	3.4
TL16H150 1008	20182502	1.5	TL22H100 1610	20182518	1.8	TL26H200 2012	20182534	3.8
TL16H200 1008	20182503	1.9	TL22H150 1615	20182519	2.7	TL26H300 2012	20182535	5.6
TL18H100 1210	20182504	1.2	TL22H200 1615	20182520	3.0	TL28H100 2012	20182539	3.0
TL18H150 1215	20182505	1.7	TL22H300 1615	20182521	4.2	TL28H150 2012	20182540	4.3
TL18H200 1215	20182506	1.9	TL24H100 1610	20182525	1.8	TL28H200 2012	20182541	5.3
TL18H300 1215	20182507	2.7	TL24H150 2012	20182526	2.4	TL28H300 2012	20182542	7.0
TL20H100 1210	20182511	1.7	TL24H200 2012	20182527	2.8			

*Weight does not include bushing.

Super Torque Pd[®] Belts

Built for strength and endurance

Super Torque Pd[®] belts are designed for high-capacity performance. They are also made of the highest quality materials.



Part Number: 100S4.5M175

100	480mm pitch length
S	Super Torque Positive Drive [®] belt
4.5M	4.5mm pitch - modified round tooth profile
175	175mm pitch length

The tensile members are made from high-strength, stable fiberglass. They have excellent flex life and are resistant to elongation. The backing is made of our proprietary compound technology that is highly heat-resistant and shear-resistant. And the nylon facing is fabricated to provide low friction interface between belt and sprocket.

A different positive drive tooth design

Continental ContiTech Super Torque Pd[®] belt tooth carries some significant advantages over competitive synchronous belts. You can run your finger along the bottom of the tooth and feel the flat surface. When the belt engages the uniquely designed pulley profile, forces are distributed throughout the entire belt tooth to disperse critical stresses over more area, resulting in reduced tooth shear and longer life.

The pulley for our Super Torque Pd[®] belt has an arch in the bottom of the grooves that projects up to support the belt tooth. This support from the pulley is the key dynamic feature to increased belt capabilities. Together, the pulley and tooth of the Super Torque Pd[®] belt extend the possibilities at both ends of the design spectrum.

Applications

Nearly every conceivable industrial drive application where precise shaft synchronization is required. Super Torque Pd[®] belts can also be used as an alternative to problem V-belt and chain drives.

- › Milling machines
- › Engine accessory drives
- › Internal combustion engines
- › Timers or controllers
- › Compressors
- › Wood chippers
- › Conveyors
- › Debarkers
- › Lathes
- › Shapers
- › Textile machinery
- › Mixers

Key features & benefits

- › Unique tooth profile for quiet tooth engagement.
- › Improved horsepower capacity over standard HTD[®] profiles.
- › High-grade compound.
- › Fiberglass tension cords for excellent resistance to shrinkage and elongation.
- › Oil, heat, ozone and abrasion resistant.
- › Mating sprockets required.
- › Low-maintenance and high-efficiency rating.

To learn more, visit www.contitech.us.

All Super Torque Pd[®] belts are nonstock. Standard factory lead times will apply. Minimums apply. Contact your PTP Industrial Distributor.

Super Torque Pd[®] Belts

Available Sizes

All Super Torque Pd[®] belts are nonstock. Standard factory lead times will apply. Mandrel quantity minimums apply. Other sizes available upon request.

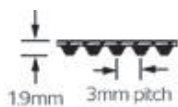

S3m

Part #	# of Teeth	Part #	# of Teeth
S3M120	40	S3M363	121
S3M150	50	S3M384	128
S3M177	59	S3M420	140
S3M201	67	S3M459	153
S3M225	75	S3M486	162
S3M252	84	S3M501	167
S3M264	88	S3M537	179
S3M276	92	S3M564	188
S3M300	100	S3M633	211
S3M339	113		

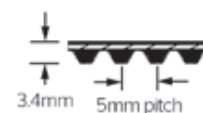

S5m

Part #	# of Teeth	Part #	# of Teeth
S5M255	51	S5M675	135
S5M295	59	S5M700	140
S5M325	65	S5M750	150
S5M350	70	S5M800	160
S5M375	75	S5M850	170
S5M400	80	S5M900	180
S5M425	85	S5M950	190
S5M435	87	S5M1000	200
S5M450	90	S5M1050	210
S5M475	95	S5M1125	225
S5M500	100	S5M1270	254
S5M525	105	S5M1350	270
S5M560	112	S5M1420	284
S5M575	115	S5M1800	360
S5M600	120	S5M2000	400
S5M625	125	S5M2770	554
S5M650	130		

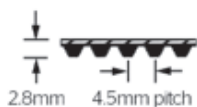

S4.5m

Part #	# of Teeth	Part #	# of Teeth
S4.5M175	39	S4.5M306	68
S4.5M180	40	S4.5M342	76
S4.5M225	50	S4.5M504	112
S4.5M247	55	S4.5M621	138
S4.5M297	66		

S8m

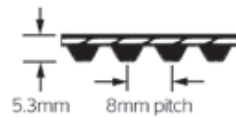

S14m*

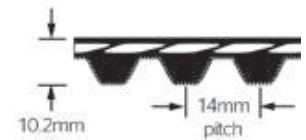

Part #	# of Teeth	Part #	# of Teeth
S8M440	55	S8M1096	137
S8M448	56	S8M1120	140
S8M480	60	S8M1136	142
S8M496	62	S8M1160	145
S8M512	64	S8M1176	147
S8M528	66	S8M1184	148
S8M560	70	S8M1200	150
S8M576	72	S8M1208	151
S8M592	74	S8M1224	153
S8M600	75	S8M1248	156
S8M632	79	S8M1256	157
S8M648	81	S8M1264	158
S8M656	82	S8M1280	160
S8M680	85	S8M1304	163
S8M688	86	S8M1312	164
S8M712	89	S8M1360	170
S8M720	90	S8M1384	173
S8M752	94	S8M1400	175
S8M760	95	S8M1432	179
S8M800	100	S8M1440	180
S8M824	103	S8M1480	185
S8M840	105	S8M1488	186
S8M848	106	S8M1544	193
S8M880	110	S8M1552	194
S8M896	112	S8M1600	200
S8M920	115	S8M1680	210
S8M928	116	S8M1696	212
S8M936	117	S8M1760	220
S8M944	118	S8M1800	225
S8M960	120	S8M2000	250
S8M976	122	S8M2032	254
S8M984	123	S8M2240	280
S8M992	124	S8M2272	284
S8M1000	125	S8M2392	299
S8M1024	128	S8M2400	300
S8M1032	129	S8M2496	312
S8M1040	130	S8M2600	325
S8M1056	132	S8M2800	350
S8M1072	134	S8M3200	400

Part #	# of Teeth	Part #	# of Teeth
S14M1120	80	S14M2310	165
S14M1190	85	S14M2450	175
S14M1400	100	S14M2590	185
S14M1540	110	S14M2800	200
S14M1610	115	S14M3150	225
S14M1778	127	S14M3500	250
S14M1890	135	S14M3850	275
S14M2002	143	S14M4004	286
S14M2100	150	S14M4508	322
S14M2240	160	S14M5012	358

*Static conductive

*Drive conditions and service variables in combination with time in operation can result in a loss of static conductivity. It is recommended that a conductivity check be added to drive preventive maintenance programs where belt static conductivity is a requirement.

Dual Hi-Performance Pd® & Dual Positive Drive Belts

Precision teeth on both sides improves efficiency with dual synchronous belts

This design allows more sophisticated, more efficient and more compact drives where a single belt is needed to provide accurate timing from either side, rotation direction changes or both.

Since a Dual Hi-Performance Pd® or Dual Positive Drive belt can replace two or more single-sided synchronous belts, less space is needed. This reduction in space means smaller sprockets can be used, bringing the weight and component cost of the drive system down considerably, contributing to a more efficient drive system.

Dual Hi-Performance Pd® belts - 8m and 14m profiles

Dual Hi-Performance Pd® belts, with their unique round tooth profile, drop into corresponding HTD® sprockets. They were designed to minimize interference between belt and sprocket during mesh, providing greater horsepower capacity without slippage or speed variation. By designing the tooth to disperse critical stresses and create a positive engagement with the sprocket, belt performance is improved along with assuring longer belt life.

Dual Positive Drive belts - XL, L and H profiles

Continental ContiTech Dual Positive Drive belts drop into existing trapezoidal profiled sprockets

High-strength tension cords

The tension-carrying member in Hi-Performance Pd® and Dual Positive Drive belts is twisted from multiple strands of fiberglass cord which are high in tensile strength, flex life and resistance to elongation.



Dual Hi-Performance Pd®

Part Number: D10408M20

D	Dual-sided
1040	1040mm pitch length
8M	8mm pitch - round tooth profile
20	20mm wide



Dual Positive Drive

Part Number: D225L050

D	Dual-sided
225	22.5 in. pitch length
L	L pitch - trapezoidal tooth profile
050	.50 in. wide

Advanced compound technology for long life

Our dual synchronous belts are made with specialized compound technology designed to resist damaging environmental factors that can shorten belt life. This compound technology has excellent oil, heat, ozone and abrasion resistance, increasing durability and preserving belt flexibility leading to extended belt life.

Applications

For precision drives where synchronized reverse rotation drive shafts are encountered and compactness is desired.

Key features & benefits

- › Dual-sided teeth versatility in 8M, 14M, XL, L and H profiles.
- › High-grade compounding.
- › Fiberglass tension cords for excellent resistance to shrinkage and elongation.
- › More compact drive designs.
- › Oil, heat, ozone and abrasion resistant.

To learn more, visit www.contitech.us.

Dual Hi-Performance Pd® Belts

Available Sizes

Other sizes available upon request.

8m

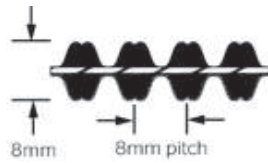

14m

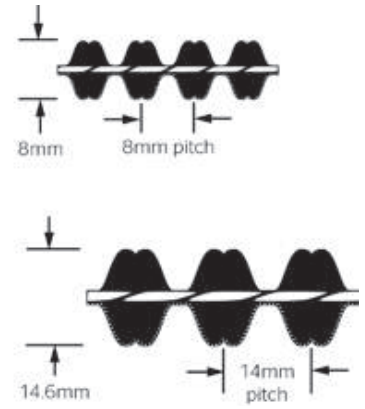

Part #	# of Teeth	Part #	# of Teeth
D720 8M	90	D1760 8M	220
D800 8M	100	D1800 8M	225
D880 8M	110	D2000 8M	250
D960 8M	120	D2400 8M	300
D1040 8M	130	D2600 8M	325
D1120 8M	140	D2800 8M	350
D1200 8M	150	D3048 8M	381
D1280 8M	160	D3280 8M	410
D1440 8M	180	D3600 8M	450
D1600 8M	200	D4400 8M	550

Available in 20, 30, 50 & 85mm widths.

Part #	# of Teeth	Part #	# of Teeth
D1400 14M	100	D3150 14M	225
D1610 14M	115	D3500 14M	250
D1778 14M	127	D3850 14M	275
D1890 14M	135	D4326 14M	309
D2100 14M	150	D4578 14M	327
D2450 14M	175	D6160 14M	440

Available in 40, 55, 85 & 115mm widths.

Dual Positive Drive Belts

Available Sizes

Other sizes available upon request. For nonstock sizes, contact your PTP Industrial Distributor.

XL (Extra Light) - 1/5 in. pitch
For business machines, instruments, sound equipment, etc.

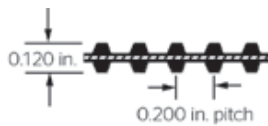

H (Heavy) - 1/2 in. pitch
For machine tools, pumps, fans, presses, motor generator sets, etc.



XL Part #	XL Part #	XL Part #
D60XL	D170XL	D290XL
D70XL	D180XL	D300XL
D80XL	D190XL	D310XL
D90XL	D200XL	D330XL
D100XL	D210XL	D362XL
D110XL	D220XL	D392XL
D120XL	D230XL	D450XL
D130XL	D240XL	D492XL
D140XL	D250XL	
D150XL	D260XL	
D160XL	D280XL	

XL Part #	XL Part #	XL Part #
D240H	D510H	D800H
D270H	D540H	D850H
D300H	D560H	D900H
D330H	D570H	D1000H
D360H	D600H	D1100H
D390H	D630H	D1250H
D420H	D660H	D1400H
D450H	D700H	D1700H
D480H	D750H	

Stock widths* 3/4 in.=075, 1 in.=100,
1 1/2 in.=150, 2 in.=200, 3 in.=300

Stock widths* 1/4 in.=025, 3/8 in.=037

L (Light) - 3/8 in. pitch
For fraction power-rated motor applications such as in-home appliances, small tools, pumps, etc.

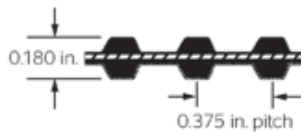

XL Part #	XL Part #	XL Part #
D124L	D270L	D420L
D150L	D285L	D450L
D187L	D300L	D480L
D210L	D322L	D510L
D225L	D345L	D540L
D240L	D367L	D600L
D255L	D390L	D660L

Stock widths* 1/2 in.=050, 3/4 in.=075, 1 in.=100

*Stock widths: Use the three-digit size number as a suffix to the belt number when ordering.

Open End Pd[®] Belts

Your choice for speed, accuracy and dependability

In power transmission or synchronization applications such as conveying, linear motion or positioning, Continental ContiTech Open End Pd[®] belts are the economical and trouble-free drive solution.



Part Number: XL 075

XL Pitch-trapezoidal tooth
075 0.75 in. wide

Economy is derived from the Open End Pd[®] belt's reduced bulk weight and lower costs compared to chain drives. Precision-molded teeth efficiently deliver the required power while running smoother and quieter than chain drives. They require less maintenance, as well as provide more design options.

Continental ContiTech Open End Pd[®] belts are available in Hawk Pd[®], Falcon Pd[®], Positive Drive Pd[®], Super Torque Pd[®] and Metric T Pd[®] constructions. Regardless of the application, the entire product line is designed to provide increased belt life, reduced overall costs and lower noise generation. In short, Open End Pd[®] synchronous belts give you the power to drive your designs better than ever.

Applications

For synchronized applications.

- › Elevation mechanisms
- › Linear motion drives
- › Open and close mechanisms
- › Reciprocating drives
- › Replaces chain applications
- › Synchronized tracking
- › Positioning drives
- › Metering drives
- › Conveying drives
- › Reversing drives
- › Fixed center drives

Key features & benefits

- › Wide load range available from various cross sections.
- › High power-to-weight ratio allows for lighter metallic or nonmetallic pulleys for greater weight savings.
- › Provides space-saving design opportunities using small pulleys, short centers and narrow belts.
- › Smooth engagement of belt and pulley eliminates chatter and vibration.
- › Low noise improves aesthetic acceptance of equipment.
- › Requires no lubrication or retensioning.

To learn more, visit www.contitech.us.

Open End Pd[®] Belts

Available Sizes

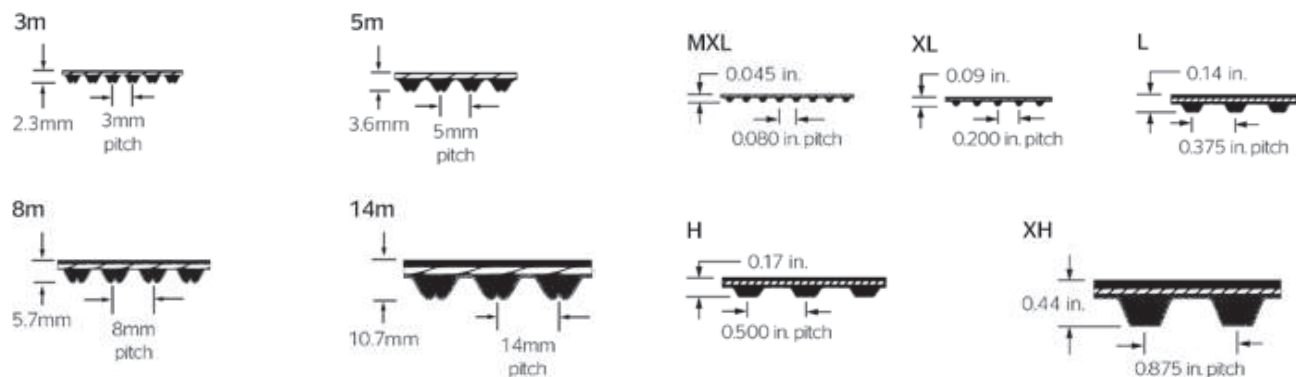

Hawk Pd[®] (Round Tooth)

Part #	Roll Length (ft.)	Roll Length (m)
3m		
3M06	285	87
3M09	190	58
5m		
5M06	935	285
5M09	620	189
5M15	367	112
5M25	217	66
8m		
8M10	633	193
8M15	420	128
8M20	312	95
8M25	246	75
8M30	203	62
8M40	151	46
8M50	92	28
8M75	56	17
14m		
14M25	308	94
14M40	184	56
14M55	128	39
14M85	75	23
14M115	49	15

Positive Drive (Trapezoidal Tooth)

Part #	Roll Length (ft.)	Roll Length (m)
MXL*		
Special Order Only	-	-
XL		
XL037	711	217
L		
L050	516	157
L075	338	103
L100	249	76
H		
H050	551	168
H075	361	110
H100	266	81
H150	170	52
H200	123	37
H300	75	23
XH*		
Special Order Only	-	-

*MXL and XH profiles available as special order only. Standard factory lead times will apply. Minimums apply. Contact your PTP Industrial Distributor.

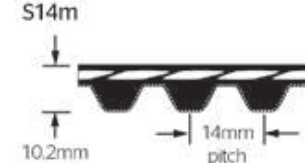
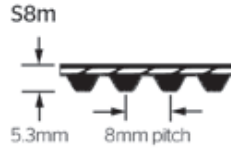
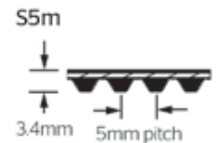
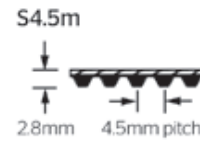
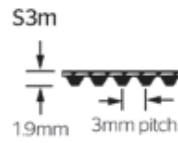
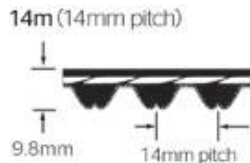
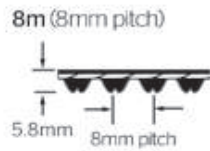

Falcon Pd®

Part #	Roll Length (ft.)	Roll Length (m)
8m (8mm pitch)		
8GTR-12	436	133
8GTR-21	243	74
8GTR-36	135	41
8GTR-62	72	22
14m (14mm pitch)		
14GTR-20	253	77
14GTR-37	128	39
14GTR-68	62	19

Metric T Pd® (Trapezoidal Tooth)

Part #	Roll Length (ft.)	Roll Length (m)
T5		
6T5	217	66
7T5	187	57
10T5	131	40
T10		
15T10	266	81
16T10	249	76
20T10	197	60
25T10	157	48
30T10	131	40
32T10	121	37
T20		
25T20	128	39

Super Torque Pd® (Round Tooth)

Part #	Roll Length (ft.)	Roll Length (m)
S3m		
50S3M	289	88
60S3M	240	73
90S3M	157	48
100S3M	144	44
S4.5m		
60S45M	236	72
100S45M	141	43
S5m		
60S5M	1050	320
100S5M	627	191
150S5M	413	126
250S5M	246	75
S8m		
100S8M	633	193
150S8M	420	128
175S8M	358	109
200S8M	312	95
250S8M	246	75
300S8M	203	62
350S8M	174	53
400S8M	151	46
S14m		
250S14M	225	69
400S14M	135	41
500S14M	104	32
600S14M	85	26

ELATECH® Polyurethane Belts

Belting for a wide variety of applications

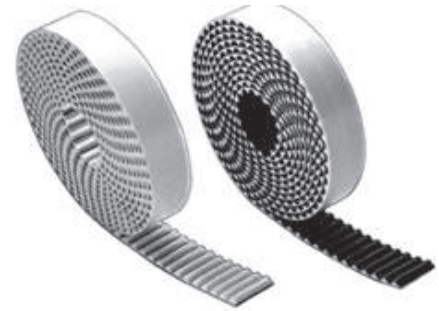

ELATECH®, distributed by Continental ContiTech, is a full line of polyurethane belting covering a full range of applications – linear motion, conveying and power transmission.

ELATECH®'s* polyurethane belts are a combination of a polyurethane body reinforced with special steel or aramid tension members to fulfill the most severe industrial requirements.

Available product styles include:

- › iSync - Truly Endless sleeves
- › ELATECH® M - Open End
- › ELATECH® V - Spliced
- › ELA-flex SD™ - Truly Endless

iSync Truly Endless sleeves can be cut and shipped in any size – usually in 24 hours. Advanced design is ideal for difficult environments where high precision is needed and cleanliness is critical, as well as heavy-duty conveying drives with special backing or cleats. ELATECH® M, ELATECH® V and ELA-flex SD™ complete the full line by providing a more customized solution with a broad range of timing belt pitches and a variety of application-specific backings.

Wide range of backings and cleat attachments

The unique chemical and mechanical characteristics of polyurethane belts along with the possibility of a variety of backings are ideal for conveying applications.

It is possible to attach a variety of cleats on all of ELATECH®'s polyurethane belts for conveying, handling and positioning.

Belt construction engineered for excellence

ELATECH® belts are manufactured with a body of thermoplastic polyurethane providing superior wear and abrasion resistance. It can be an ideal choice where cleanliness is critical. The precise manufacturing process, coupled with the polyurethane belt material, ensures a reliable and dimensionally stable product.

The tension members are high tensile steel that offer excellent dimensional stability for accurate positioning and less maintenance. Construction with special cords is available upon request.

A special polyamide fabric on the tooth facing (special order) can reduce friction, improve tooth engagement and reduce noise.

Built for extreme conditions

The chemical properties of polyurethane belting make them highly resistant to:

- › Hydrolysis
- › UVA
- › Oils, greases and fats
- › Good resistance to acids
- › Ozone
- › Aging
- › Gasoline

ELATECH®'s product line has a working temperature range of 15°F to 175°F (-9.4°C to 79.4°C) and peaks up to 230°F (110°C).

*ELATECH is a registered trademark of ELATECH S.r.l.

More information

Full product offering, technical data and drive data can be obtained in the ELATECH®* Polyurethane Belts catalog.

Applications

Polyurethane belts can be used in open end, jointed/spliced or Truly Endless configurations in a variety of applications.

Typical applications for the open end configuration are in linear motion devices and other drives where precise motion is required.

Typical applications for the spliced configuration are in light conveyors and other material process and transfer industries.

Truly Endless due to having no splice or welding; are ideal in high load conveying or power transmission applications.

Key features & benefits

- › Polyurethane material resists flaking, has higher dimensional stability and superior wear and abrasion resistance.
- › Higher flexibility.

Contact your PTP Industrial Distributor or go to www.contitech.us to locate one.

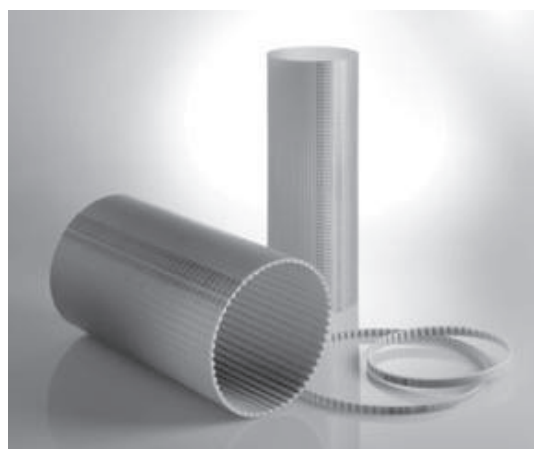

*ELATECH is a registered trademark of ELATECH S.r.l.

ELATECH®* Polyurethane Belts

Distributed by
Continental ContiTech

Available Sizes

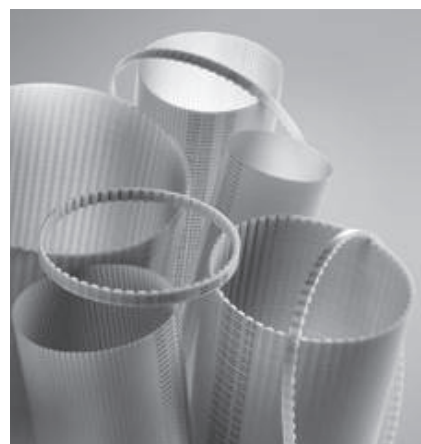

T

Width (mm)			
T2.5	T5	T10	T20
4	10	10	25
6	12	16	32
10	16	20	50
20	20	25	5
50	25	32	100
100	32	50	150
	50	75	
	75	100	
	100	150	

AT

Width (mm)		
AT5	AT10	AT20
10	10	25
12	16	32
16	25	50
20	32	75
25	50	100
32	75	150
50	100	
75	150	
100		

iSync - Truly Endless

Profile	Lengths (mm)	Maximum Widths (mm)
T2.5	120 - 950	300-400
T5	165 - 1440	
T10	260 - 2250	
AT5	330 - 1050	
AT10	560 - 1940	

ATL

Width (mm)		
ATL5	ATL10	ATL20
10	10	25
12	16	32
16	25	50
20	32	75
25	50	100
32	75	150
50	100	

HTD®

Width (mm)			
HTD®3M	HTD®5M	HTD®8M	HTD®14M
10	10	10	40
15	15	15	55
25	25	20	85
50	50	30	100
100	100	50	115
		85	
		100	

RTD

Width (mm)		
RTD5M	RTD8M	RTD14M
10	10	40
15	15	55
25	20	85
50	30	100
100	50	115
	85	
	100	

STD

Width (mm)

STD5M	STD8M
10	10
15	15
25	20
50	30
100	50
	85
	100

Flat

Width (mm)

F1	F2	F3
10	25	25
25	50	50
50	75	75
100	100	100

Inch

Width (mm)

XL	L	H	XH
6.35	12.7	12.7	25.4
9.4	19.05	19.05	38.1
12.7	25.4	25.4	50.8
19.05	38.1	38.1	76.2
25.4	20.8	20.8	101.6
38.1	101.6	76.2	
50.8		101.6	
101.6			

TK

Width (mm)

TK-K6	TK10-K13
16	25
25	32
32	50
50	75
75	100
100	

ATK

Width (mm)

ATK5-K6	ATK10-K13
16	25
25	32
32	50
50	75
75	100
100	

*ELATECH is a registered trademark of ELATECH S.r.l.

Acculinear® Belts and Sprockets

A revolutionary choice for a wide range of applications now in polyurethane material

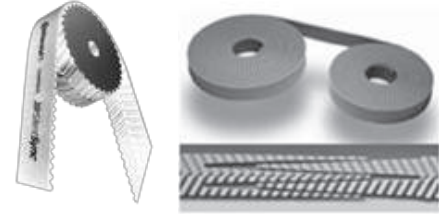

When it comes to performance, Acculinear® belts and sprockets are right on track.

Part Number: Y-8-PU-16-STD

Y	Alphabetical designation denotes belt width (Y=16mm wide belt)
8	8mm belt pitch
PU	Polyurethane
16	Belt width (16mm)
STD	Standard construction

The benefits of Acculinear® synchronous belts

Acculinear® combines the advantages of polyurethane with the unique Helical Offset Tooth (H.O.T.) geometry for a low-maintenance belt that resists wear. Polyurethane belts resist flaking, offer high resistance to oils, fats and greases and are more abrasion-resistant than rubber products.

Self-tracking sprocket

The key to success lies in the system's patented H.O.T. geometry. With this self-tracking configuration, the sprocket's left and right helixes guide the thermoplastic polyurethane belt to the center of the Acculinear® sprocket. And there it remains: no waste, no wander, just improved efficiency and wear resistance in a compact design. The H.O.T. geometry eliminates belt wander and the need for flanges. As a result, Acculinear® sprockets can be used on slider bed applications where flanges would normally protrude above the bed surface.

Low vibration

Acculinear® and the H.O.T. design minimize belt vibration on flat pulleys used on the entry and exit of slider beds. The belt moves progressively over straight edges, reducing noise and vibration.

The tooth geometry eliminates the chordal effect that occurs around the tooth sprocket and reduces drive vibration.

H.O.T. geometry delivers quieter drive

This innovative polyurethane belt and sprocket system uses our proprietary technology to deliver noise levels far below the industry standard. The unique design of Acculinear® belts and sprockets is the reason for the system's superior noise reduction. The self-tracking belt is guided to the center of the sprocket - delivery that smooths out tooth engagement unlike any other tooth geometry.

Belt constructions engineered for excellence

The tooth and backing material are made of thermoplastic polyurethane, which provides superior wear and abrasion resistance. It is an ideal choice in applications where cleanliness is critical. The precise manufacturing process, coupled with the polyurethane belt material, ensures a reliable and dimensionally stable product.

The tension members are high tensile steel and offer excellent dimensional stability for accurate positioning and less maintenance.

The tooth facing offers reduced coefficient of friction with the sprocket and also provides wear and abrasion protection.

To learn more, visit www.contitech.us.

Applications

Acculinear® belts can be used in open end or spliced configurations in a variety of applications.

Typical applications for the open end configuration are in linear motion devices and other drives where precise motion is required.

Typical application for the spliced configuration are in light conveyors and other material processing and transfer industries.

Key features & benefits

- > Polyurethane material resists flaking, has higher dimensional stability, superior wear and abrasion resistance.
- > Self-tracking and compact drives.
- > Less vibration and reduced noise.
- > High flexibility.
- > High-precision linear positioning.

Open End Pd® belt configuration

Acculinear® belts are manufactured in open end rolls with a standard roll length of 300 feet. The belt is manufactured with the tension members lying parallel to the belt edge so that the load is equally distributed across all tension members. A common application of open end belts is in linear motion drives. Clamping plates are available for open end Acculinear® belts to mechanically join the belt's ends.

Linear Motion Drive (Open End Pd® belt)

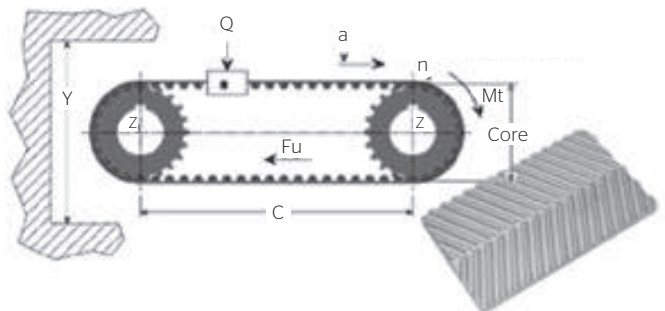

Spliced belt configuration

Lengths of open end Acculinear® can also be thermically spliced to obtain any continuous length of endless belting. These spliced Acculinear® belts are primarily used in light conveyor applications, where long endless belts are required.

Linear Conveyance Application (Spliced belt)

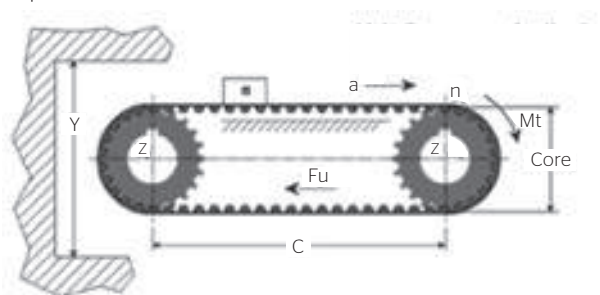

Acculinear® Belts and Sprockets

Sprockets

Acculinear® Sprockets for the polyurethane belt line are available for all eight belt widths in a wide range of diameters.

The Acculinear® product shares the same sprockets as the rubber SilentSync® product. The only exception is with the "M" (25mm width) and the "L" (50mm width) sprockets. These two widths are stocked in aluminum and are offered in a limited size range. All other sprocket widths are stocked either in ductile or cast iron. Refer to the "Acculinear® Sprocket" section for more information.

Special belt constructions

In addition to the standard belt construction (polyurethane backing material), Acculinear® is available in a variety of special constructions. Several materials can be applied to the back of the belt to enhance its performance in specific drive environments. These backing materials are typically used when special characteristics are required on the back of the belt to transfer specific materials in conveyor applications.

A number of special backings are available on request. Refer to the appropriate engineering manual or to the website for more information on these special backings.

Available in eight standard widths

(in 8mm and 14mm pitch configurations)

Sample Part Number
Y - 8 - Pu - 16 - Std
Belt Type: Open End Pd®
Belt Length: 800mm

Y = Acculinear® 16mm wide belt

8 = 8mm pitch

PU = Polyurethane

16 = Belt width, in mm

STD = Belt construction (STD = Standard construction)

Alphabet Designation

Denotes belt width.

Example: Y = 16mm wide belt

Belt Pitch

(8mm and 14mm)

PU

for Polyurethane

Belt Width

in mm

1:	Y	-	8	-	PU	-	16
2:	M	-	8	-	PU	-	25
3:	W	-	8	-	PU	-	32
4:	L	-	8	-	PU	-	50
5:	B	-	14	-	PU	-	35
6:	G	-	14	-	PU	-	52.5
7:	O	-	14	-	PU	-	70
8:	R	-	14	-	PU	-	105

State Belt Construction

State "Open End" or "Spliced"

State Belt Pitch Length

Acculinear® Sprockets

Available Sizes

Notes:

1. Al = Aluminum (uncoated).
2. Sprockets are only available in MPB.
3. The "L" (50mm width) and "M" (25mm width) belts are nonstock items which need to be quoted and may have a longer lead time.
4. Sprocket dimensions and material are subject to change.
5. Please contact your PTP Industrial Distributor for sprocket sizes and materials not listed in this manual or visit www.contitech.us to locate one.

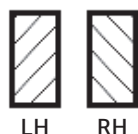

> LH is the left-hand helix.
> RH is the right-hand helix.

Note: For proper installation orientation of teeth must be in the same direction on all sprockets in the drive.

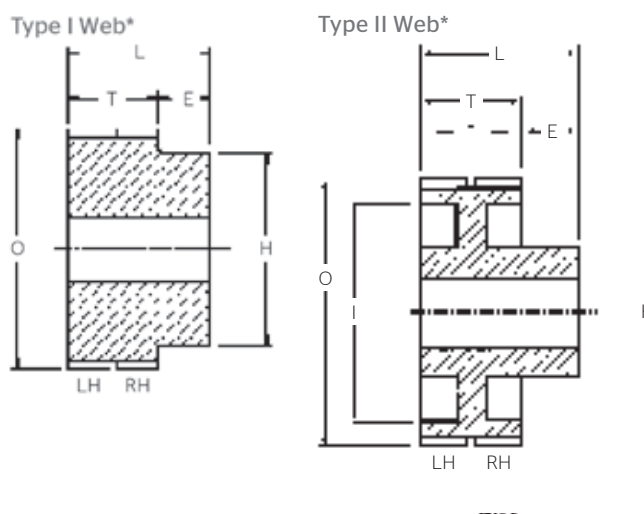

Acculinear® Sprockets for 25mm Wide Belt

Sprocket face width (F) = 26mm, pitch = 8mm

Sprocket Part #	Hub*	Bore Range (in.)		# of Teeth	Type*	Pitch Diameter (in.)	O I E H T L						Material	Wt. (lb.)	Approx. WR ² (lb.-ft. ²)
		Min.	Max.				Inch (Refer to Type I above)								
M-20S-MPB	MPB	0.5000	1.0630	20	1	2.0050	1.9508	-	0.4700	1.6000	-	1.5000	Al	0.33	0.0009
M-22S-MPB	MPB	0.5000	1.2200	22	1	2.2060	2.1513	-	0.4700	1.8100	-	1.5000	Al	0.41	0.0015
M-24S-MPB	MPB	0.5000	1.3390	24	1	2.4060	2.3518	-	0.6300	2.0100	-	1.6500	Al	0.55	0.0023
M-26S-MPB	MPB	0.5000	1.5350	26	1	2.6070	2.5523	-	0.6300	2.2800	-	1.6500	Al	0.68	0.0034
M-28S-MPB	MPB	0.5000	1.6140	28	1	2.8070	2.7528	-	0.6300	2.4400	-	1.6500	Al	0.80	0.0047
M-30S-MPB	MPB	0.5000	1.7720	30	1	3.0080	2.9533	-	0.6300	2.6400	-	1.6500	Al	0.93	0.0063
M-32S-MPB	MPB	0.5000	1.8900	32	1	3.2080	3.1538	-	0.6300	2.8300	-	1.6500	Al	1.08	0.0083
M-34S-MPB	MPB	0.5000	2.0080	34	1	3.4090	3.3543	-	0.6300	3.0300	-	1.6500	Al	1.23	0.0108
M-36S-MPB	MPB	0.5000	2.1650	36	1	3.6090	3.5549	-	0.6300	3.2300	-	1.6500	Al	1.40	0.0138
M-38S-MPB	MPB	0.5000	2.2830	38	1	3.8100	3.7554	-	0.6300	3.4300	-	1.6500	Al	1.57	0.0174
M-40S-MPB	MPB	0.5000	2.4410	40	1	4.0100	3.9559	-	0.6300	3.6200	-	1.6500	Al	1.75	0.0217
M-56S-MPB**	MPB	0.5000	3.5040	56	1	5.6140	5.5600	-	0.6300	5.2400	-	1.6500	Al	3.53	0.0903
M-90S-MPB**	MPB	1.0000	2.8740	90	2	9.0230	8.9686	8.0299	0.6300	4.7200	0.3150	1.6500	Al	5.29	0.2867

**These sprocket sizes are nonstock items.

Sprockets with Minimum Plain Bore (MPB) are specified when the sprocket does not allow room for a bushing that will handle the maximum load.

Acculinear® Sprockets

Available Sizes

Notes:

1. Al = Aluminum (uncoated).
2. Sprockets are only available in MPB.
3. The "L" (50mm width) and "M" (25mm width) belts are nonstock items which need to be quoted and may have a longer lead time.
4. Sprocket dimensions and material are subject to change.
5. Please contact your PTP Industrial Distributor for sprocket sizes and materials not listed in this manual or visit www.contitech.us to locate one.

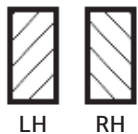

> LH is the left-hand helix.
> RH is the right-hand helix.

Note: For proper installation orientation of teeth must be in the same direction on all sprockets in the drive.

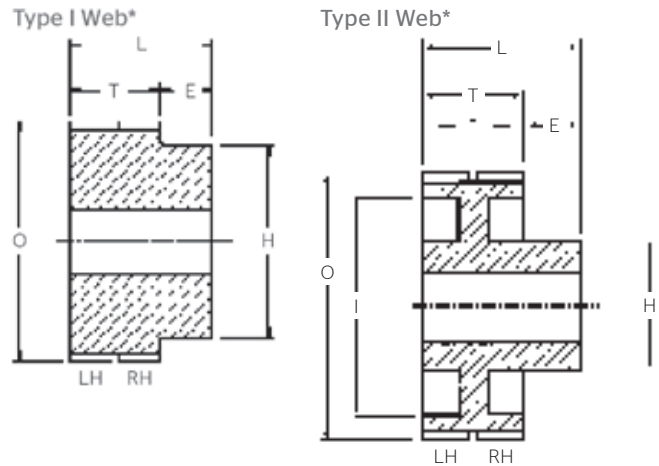

Acculinear® Sprockets for 50mm Wide Belt

Sprocket face width (F) = 51mm, pitch = 8mm

Sprocket Part #	Bore Range (in.)			# of Teeth	Type*	Pitch Diameter (in.)	O	I	E	H	T	L	Material	Wt. (lb.)	Approx. WR ² (lb.-ft. ²)
	Hub*	Min.	Max.				Inch (Refer to Type I above)								
L-20S-MPB	MPB	0.500	1.063	20	1	2.005	1.9508	-	0.4700	1.6000	-	2.4800	Al	0.55	0.0027
L-22S-MPB	MPB	0.500	1.220	22	1	2.206	2.1513	-	0.4700	1.8100	-	2.4800	Al	0.69	0.0036
L-24S-MPB	MPB	0.500	1.339	24	1	2.406	2.3518	-	0.6300	2.0100	-	2.6400	Al	0.90	0.0054
L-26S-MPB	MPB	0.500	1.535	26	1	2.607	2.5523	-	0.6300	2.2800	-	2.6400	Al	1.10	0.0072
L-28S-MPB	MPB	0.500	1.614	28	1	2.807	2.7528	-	0.6300	2.4400	-	2.6400	Al	1.29	0.0089
L-30S-MPB	MPB	0.500	1.772	30	1	3.008	2.9533	-	0.6300	2.6400	-	2.6400	Al	1.51	0.0111
L-32S-MPB	MPB	0.500	1.890	32	1	3.208	3.1538	-	0.6300	2.8300	-	2.6400	Al	1.74	0.0138
L-34S-MPB	MPB	0.500	2.008	34	1	3.409	3.3543	-	0.6300	3.0300	-	2.6400	Al	1.99	0.0179
L-36S-MPB	MPB	0.500	2.165	36	1	3.609	3.5549	-	0.6300	3.2300	-	2.6400	Al	2.25	0.0228
L-38S-MPB	MPB	0.500	2.283	38	1	3.810	3.7554	-	0.6300	3.4300	-	2.6400	Al	2.53	0.0287
L-40S-MPB	MPB	0.500	2.441	40	1	4.010	3.9559	-	0.6300	3.6200	-	2.6400	Al	2.83	0.0357
L-56S-MPB**	MPB	0.500	3.504	56	1	5.614	5.5600	-	0.6300	5.2400	-	2.6400	Al	5.65	0.1470
L-90S-MPB**	MPB	1.000	2.874	90	2	9.023	8.9686	8.0299	0.6300	4.7200	0.3937	2.6400	Al	8.16	0.4820

**These sprocket sizes are nonstock items.

Sprockets with Minimum Plain Bore (MPB) are specified when the sprocket does not allow room for a bushing that will handle the maximum load.

Acculinear® Clamping Plates

Available Sizes

Clamping Plates are available for Acculinear® Open End Pd® belts to allow them to be used in linear motion devices.

#	Belts	A (mm)	B (mm)	L (mm)	Material
Acculinear® - 8mm - Clamping Plate					
1:	Y-8-PU-16	12	75	120	Aluminum
2:	M-8-PU-25	12	75	120	Aluminum
3:	W-8-PU-32	12	75	120	Aluminum
4:	L-8-PU-50	12	75	120	Aluminum
Acculinear® - 14mm - Clamping Plate					
5:	B-14-PU-35	18	130	200	Aluminum
6:	G-14-PU-52.5	18	130	200	Aluminum
7:	O-14-PU-70	18	130	200	Aluminum
8:	R-14-PU-105	18	130	200	Aluminum

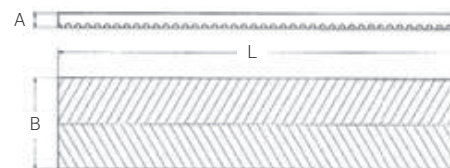
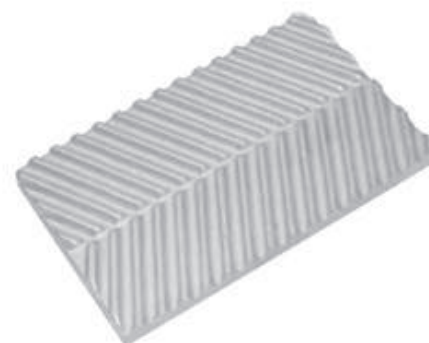

Banded Belts

Because of their banded or joined construction, these belts tend to prevent rollover and reduce vibration tendencies

Banded belts are usually better suited to unusual drive situations than are matched belt sets. They are available in the Classical cross sections (A, B, C and D), Narrow cross sections (3V, 5V and 8V) and Poly-V® cross sections (H, J, L and M).

Classical and Narrow Banded V-belts

Typical applications for Banded V-belts include vertical shaft drives, clutching drives and V-flat drives. (V-belt drives are where the inside of the belt drives a flat pulley on the slower speed shaft.)

Banded V-belts are recommended for use where belt vibration or belt whip causes unsatisfactory results when conventional multiple single V-belts are used. Such situations are not uncommon on drives with a combination of long belt spans and/or pulsating loads as created by an internal combustion engine or reciprocating pumps and compressors. In such cases, belt whip may become so severe that belts interface with each other and turn over in the grooves or even jump out of the grooves. Banded V-belts eliminate such problems.

Another advantage of Banded V-belts is the considerable degree of design flexibility they can provide since they operate just as effectively when they, in turn, are used as match sets. A two-belt unit for example, has sufficient lateral rigidity so as to not interface with the units in adjacent grooves.

Torque Team Plus® (aramid-reinforced Banded V-belts)

These belts are available for low-speed, high-power applications which were previously considered to be in the domain of chain or gears. Aramid-reinforced Torque Team Plus® 5V and 8V Banded belts are ideally suited to handle many of the applications that have been reserved for chain or gears.

Poly-V® (V-ribbed)

Poly-V® belts are flat belts with a series of longitudinal ribs on the driving face that mate with grooves in the sheave rim. Relatively thin, with a well-supported tensile member, these belts perform better than V-belts on drives with small sheave, high speeds, reverse bends and high-speed ratios. Poly-V® belts generally run smoother than V-belts and their low weight makes them suitable for high-speed drives.

Three cross sections, designated J, L and M, handle the same range of industrial applications as Narrow or Classical belts. A smaller section, H, is used for small sheave and miniature drives. Finally, the K section Poly-V® is often located in the automotive industry.

Torque Team® (Laminated) V-Belts

Solve the toughest sawmill drive problems

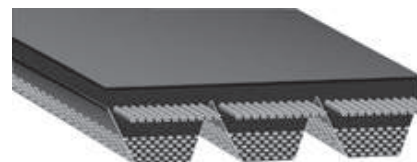

Continental ContiTech Torque Team® Laminated V-belts are particularly effective when installed on drives that experience frequent slippage caused by logs and heavy lumber that jam or impact the equipment.

Part Number: 3/5VL800

3/	3 rib joined construction
5V	0.62 in. top width - Narrow profile rib
L	Laminated construction
800	80.0 in. nominal outside length

Reduce downtime and maintenance

Continental ContiTech Torque Team® Laminated V-belts can withstand the punishment that results from jams in log and lumber processing applications.

Standard V-belts resist slipping when a jam occurs, causing excessive heat buildup that can lead to belt failure and costly downtime. But that won't happen with Torque Team® Laminated V-belts on the job.

The special sidewall of Torque Team® Laminated V-belts acts as a control switch, allowing the belts to slip as needed until the obstruction is cleared. As a result, the superior wear-resistant capabilities of Torque Team® Laminated V-belts are maintained, increasing belt life up to four times longer than standard V-belts.

High strength for long life

Continental ContiTech Torque Team® Laminated V-belts feature our powerful Vytacord® tensile members. Vytacord® provides high strength and horsepower ratings, yet serves as a more forgiving reinforcement that will give under excessive tension instead of snapping. That means increased belt life.

Sizes

5VL800	5VL1000	5VL1250
5VL850	5VL1060	5VL1320
5VL900	5VL1120	5VL1700
5VL950	5VL1180	

For longer 5V, as well as 3V and 8V laminated profiles not listed here, contact your PTP Industrial Distributor.

Available in a wide variety of sizes

Continental ContiTech Torque Team® Laminated V-belts are available in the 5VL belt cross section and in most standard lengths. The 5VL laminated V-belt is interchangeable with all standard 5V and 5VX V-belts currently found on these drives. They can also be cut to a variety of rib widths, depending on your drive requirements. This ensures a perfectly-matched set of V-belts that can further enhance drive performance.

5VL Cross Section View



Applications

Some of the most common drives recommended for consideration include:

- > Debarkers
- > Chip-n-saws
- > Cut-off saws
- > Chippers
- > Gang saws
- > Deck saws
- > Trimmers

Key features & benefits

- > Narrow profile ribs provide savings through efficiency.
- > Joined construction for problem drives.
- > High horsepower capacity.
- > High-strength Vytacord® tensile members.
- > Laminated construction engineered to slip.
- > Tough fabric backing.
- > Oil, heat, ozone and abrasion resistant.
- > Static conductive.*

*Drive conditions and service variables in combination with time in operation can result in a loss of static conductivity. It is recommended that a conductivity check be added to drive preventive maintenance programs where belt static conductivity is a requirement.

HY-T® Wedge Torque Team® Belts

Tame your problem drives

Built with multiple belts joined by a tough, rubber-impregnated fabric backing that regulates belt travel so all ribs pull together as a single, perfectly matched team.



Part Number: 3/8V1900

3/	3 rib joined construction
8V	1 in. top width - Narrow profile rib
1900	190 in. nominal outside length
	Single envelope ply on 5Vs
	2 envelope plies on 8Vs
	Envelope uncogged construction shown

Pulsation, vibration, shock loads and misalignment are problems for any team of V-belts, no matter how perfectly matched the individual units. These conditions often lead to chronic belt whip or to belt turnover, resulting in premature wear or sudden failure of one or more belts. Of course, when one belt goes, the whole team has to be replaced.

Each rib in a HY-T® Wedge Torque Team® belt is free to wedge into the sheave groove for maximum traction, maximum power and transmission efficiency.

Operating in standard sheave grooves without sheave or drive modification, they can tame any problem drives now in operation. Or they can fit right in with your new drive designs without special modifications.

Designed and built to deliver superior performance

V-belt performance begins with the tension members, so we built HY-T® Wedge Torque Team® V-belts with super strong Vytacord®. It provides the high-strength, high-horsepower rating capacity needed to effectively transmit drive power. And it is tough enough to tolerate the misalignment that quickly destroys belts. The Vytacord® material is a polyester construction with excellent strength and minimal elongation. Drive performance is consistent, reliable and predictable over the life of the belt.

We then add a tough oil- and abrasion-resistant fabric backing to provide maximum longitudinal flexibility and lateral strength to withstand the dynamic forces acting within a joined belt. The backing also has special adhesion characteristics that enable it to bond to the V-sections to maintain the integrity of

the belt. The cushion is made of fiber-reinforced, engineered compounds providing oil, heat, ozone and abrasion resistance.

Wedge or envelope constructions provide optimum performance

HY-T® Wedge Torque Team® belts are available in a raw edge construction with cogs for increased flexibility and heat dissipation or envelope construction for drives where pulsation, shock loads, high tension and long center are involved.

HY-T® Wedge Torque Team® cogged belts have high-horsepower belt construction and are identified with a 3VX or 5VX prefix and are available in lengths up to 140 inches. The cogged construction provides the high flexibility required for short center distances. The cogs also provide a larger surface area to dissipate heat and prolong belt life. Improved material properties and advanced construction technology result in an average horsepower increase of 30% over standard joined "Classical" V-belts.

HY-T® Wedge Torque Team® envelope belts are identified with a 3V, 5V or 8V prefix and are recommended for drives where pulsation, shock loads, high tension and long centers are involved. They feature a continuous V-section that is protected by a wide angle, synthetic fabric-impregnated, high-quality rubber compound. The unique envelope achieves the high strength that the HY-T® Wedge Torque Team® belts need to withstand high loading forces. It also helps provide the torsional rigidity in long center drives delivering the traction needed for accurate tracking and precision performance.

Envelope 5V, 8V Cross Section



Cut Edge 3VX, 5VX Cross Section



Cut Edge Side View



Matchmaker® performance

Our Matchmaker® technology results in belt consistency run to run. That means each HY-T® Wedge Torque Team® is equal in size and performance to every other HY-T® Wedge Torque Team® belt in that size, no matter when or where it was produced.

By eliminating mismatch problems, there is no costly and complicated belt matching to get a drive back on line; no problems with belts that are too tight or too loose.

Available in the most extensive stock line in the industry

HY-T® Wedge Torque Team® belts are available from stock in any number of belts per team, up to the number of ribs indicated. Nonstock lengths are also available in these rib counts, up to a maximum of 730 inches (180 inches for 3V cross sections).

Applications

For shock load applications. Ideal for pulsating loads, high capacity drives and for short-center, heavy-duty drives.

Key features & benefits

- › Narrow profile ribs provide savings through efficiency.
- › Joined construction for problem drives.
- › Strong Vytacord® tensile members.
- › Tough fabric backing.
- › Oil, heat, ozone and abrasion resistant.
- › Available in raw edge construction with cogs or envelope construction.
- › Matchmaker® to eliminate mismatch.
- › Static conductive.*

*Drive conditions and service variables in combination with time in operation can result in a loss of static conductivity. It is recommended that a conductivity check be added to drive preventive maintenance programs where belt static conductivity is a requirement.

HY-T® Wedge Torque Team® Belts

Cross Sections and Lengths Available

Part #	Max. # of Ribs Per Slab	Part #	Max. # of Ribs Per Slab	Part #	Max. # of Ribs Per Slab	Part #	Max. # of Ribs Per Slab
3VX							
3VX250	90	3VX400	90	3VX630	90	3VX950	90
3VX265	90	3VX425	90	3VX670	90	3VX1000	90
3VX280	90	3VX450	90	3V670	90	3VX1060	90
3VX300	90	3VX475	90	3VX710	90	3VX1120	90
3VX315	90	3VX500	90	3VX750	90	3VX1180	90
3VX335	90	3VX530	90	3VX800	90	3VX1250	90
3VX355	90	3VX560	90	3VX850	90	3VX1320	90
3VX375	90	3VX600	90	3VX900	90	3VX1400	90
5V, 5VX							
5VX500	53	5VX850	53	5V1120	42	5V2000	42
5VX530	53	5V850	42	5VX1180	53	5V2120	42
5VX560	53	5VX900	53	5V1180	42	5V2240	42
5VX600	53	5V900	42	5VX1250	53	5V2360	42
5VX630	53	5VX950	53	5VX1320	53	5V2500	42
5VX670	53	5V950	42	5VX1400	53	5V2650	42
5VX710	53	5VX1000	53	5V1500	42	5V2800	42
5VX750	53	5V1000	42	5V1600	42	5V3000	42
5V750*	53	5VX1060	53	5V1700	42	5V3150	42
5VX800	53	5V1060	42	5V1800	42	5V3350	42
5V800	42	5VX1120	53	5V1900	42	5V3550	42
8V							
8V1000	14	8V1600	24	8V2500	24	8V4000	24
8V1060	14	8V1700	24	8V2650	24	8V4250	24
8V1120	14	8V1800	24	8V2800	24	8V4500	24
8V1180	14	8V1900	24	8V3000	24	8V4750	24
8V1250	24	8V2000	24	8V3150	24	8V5000	24
8V1320	24	8V2120	24	8V3350	24	8V5600	24
8V1400	24	8V2240	24	8V3550	24	8V6000	24
8V1500	24	8V2360	24	8V3750	24		

*Cut edge, non-cogged.

Torque Team Plus® Belts

Performance plus for high horsepower drives

Torque Team Plus® belts are our highest capacity V-belts known for strength, durability and performance.

Torque Team Plus® belts' tension members are aramid cable cords. They are twisted from aramid fiber, which is five times stronger than steel, then are treated for improved adhesion, improved flex life and increased resistance to shrinkage. Torque Team Plus® belts exhibit only one-half of the initial elongation of other belts and maintain greater dimensional stability over the life of the belt. They stand up to higher horsepower, high-tension drive requirements, shock loads and abusive installations better than standard joined belts, multiple V-belt teams or chain and sprocket drives.

The cushion is made of a highly engineered compound that resists harsh operating environments and compression fatigue. The envelope is also rubber compound-impregnated to protect the carcass from abrasion, heat, ozone and oil. Together, these components offer a strong, flexible and efficient belt with extended service life.

The advantages of Torque Team Plus® belting

With Torque Team Plus®, there is less cost involved in the drive design due to the fact that each belt can handle a given load with a narrower width belt than either multiple V-belt or chain and sprocket drives. This means that there is less cost incurred for the drive medium (belts/chains), less cost for the narrower sheaves and pulleys they use and less cost for the downtime and labor involved in the retensioning required by both multiple V-belt and chain belt drives. There is no need for the lubricants and lubrication system that chain drives need. These are some very clear advantages, especially when you consider that you get these savings along with a dramatic performance advantage.

There is also less weight because the smaller sheaves used for drives using Torque Team Plus® belts are a dramatic 50% lighter than a sheave required to drive an equal horsepower multiple V-belt drive. When compared to an equal horsepower chain drive, the sheave weighs an incredible 65% less than the sprocket required for the chain drive.

Torque Team Plus® is more compact. In fact, a typical Torque Team Plus® belt is only one-third the width of an equivalent

multiple V-belt team. It needs 17% less space than an equivalent chain drive.

And since Torque Team Plus® belts give you all the advantages of the joined principal (smooth tracking, no belt turnover, no matching problems, less belt threatening vibration, even and consistent tensioning), there is less maintenance required.

Premium Torque Team Plus® belts require adequate sheaves

The high strength of Torque Team Plus® belts provides exceptional high-torque capabilities and horsepower ratings. These high belt capacities may exceed standard sheave capabilities. To assure safety and satisfactory drive operation, consult your sheave supplier for sheave recommendations.

Applications

Ultimate upgrade belt; for all heavy-duty industrial machinery and equipment. Ideal for operation in harsh elements on the toughest high horsepower drives.

- › Crushers
- › Saws
- › Sanders
- › Screens
- › Dryers
- › Lathes
- › Blow tanks
- › Chain drives
- › Washers

Key features & benefits

- › Narrow profile ribs provide savings through efficiency.
- › Joined construction for problem drives.
- › Up to 50% more horsepower capacity.
- › High-strength aramid tensile members.
- › Oil, heat, ozone and abrasion resistant.
- › Static conductive.*

To learn more, visit www.contitech.us.

*Drive conditions and service variables in combination with time in operation can result in a loss of static conductivity. It is recommended that a conductivity check be added to drive preventive maintenance programs where belt static conductivity is a requirement.



Part Number: 3/5VF2000

3/	3 rib joined construction
5V	0.62 in. top width - Narrow profile rib
F	Torque Team Plus® with aramid tensile member
2000	200 in. nominal outside length Single envelope ply on 5Vs, 2 envelope plies on 8Vs

Torque Team Plus® Belts

Cross Sections and Lengths Available

Torque Team Plus® was designed to belt a drive with one multi-ribbed belt. They are not to be used in matching sets. If multiple Torque Team Plus® belts are to be used on the same drive, they should be cut from the same production slab.

5VF and 8VF Cross Section View



Part #	Max. # of Ribs Per Slab	Part #	Max. # of Ribs Per Slab	Part #	Max. # of Ribs Per Slab	Part #	Max. # of Ribs Per Slab
5VF							
5VF900	42	5VF1320	42	5VF2000	42	5VF3000	42
5VF950	42	5VF1400	42	5VF2120	42	5VF3150	42
5VF1000	42	5VF1500	42	5VF2240	42	5VF3350	42
5VF1060	42	5VF1600	42	5VF2360	42	5VF3550	42
5VF1120	42	5VF1700	42	5VF2500	42		
5VF1180	42	5VF1800	42	5VF2650	42		
5VF1250	42	5VF1900	42	5VF2800	42		
8VF							
8VF1250	24	8VF1900	24	8VF2800	24	8VF4250	24
8VF1320	24	8VF2000	24	8VF3000	24	8VF4500	24
8VF1400	24	8VF2120	24	8VF3150	24	8VF4750	24
8VF1500	24	8VF2240	24	8VF3350	24	8VF5000	24
8VF1600	24	8VF2360	24	8VF3550	24	8VF5600	24
8VF1700	24	8VF2500	24	8VF3750	24	8VF6000	24
8VF1800	24	8VF2650	24	8VF4000	24		

HY-T® Torque Team® Classical Belts

Designed and built to deliver superior performance

HY-T® Torque Team® Classical belts are built with strong Vytacord® tension members. This provides the high-strength, high-horsepower rating capacity needed to effectively transmit drive power.

Vytacord® tension members are tough enough to tolerate the misalignment that quickly destroys belts. The Vytacord® material has a very good dimensional stability. Drive performance is consistent, reliable and predictable over the life of the belt.

We then add a tough oil- and abrasion-resistant fabric backing to provide maximum longitudinal flexibility and lateral strength to withstand the dynamic forces acting within a joined belt. The backing also has special adhesion characteristics that enable it to bond inseparably to the V-sections to maintain the unitary integrity of the belt.

The cushion in both envelope and cut-edge construction is fiber-loaded. Cut-edge constructions have a fiber-loaded, latest-technology compound that contributes heat and oil resistance and strength.

Cut-edge or envelope construction provide optimum performance

HY-T® Torque Team® Classical belts are available in a cut-edge construction with cogs for increased flexibility and heat dissipation or envelope construction for drives where pulsation, shock loads, high tension and long centers are involved.

HY-T® Torque Team® cogged belts are high horsepower belt constructions identified with a BX or CX prefix and are available in lengths up to 136 inches. The cogged construction provides the high flexibility required for short center distances. The cogs also provide a larger surface area to dissipate heat and to prolong belt life.

HY-T® Torque Team® envelope belts are identified with a B or C prefix and both cogged and non-cogged are static conductive. They are recommended for drives where pulsation, shock loads, high tension and long centers are involved.



Part Number: 3/BX112

3/	3 rib joined construction
B	0.66 in. top width - Classical profile rib
X	Premium cogged construction
112	Approximate 112 in. inside length Cut-edge, molded cog construction shown

Matchmaker® performance

Our Matchmaker® technology results in belt consistency run to run. That means each HY-T® Torque Team® Classical belt is equal in size and performance to every other HY-T® Torque Team® Classical belt in that size, no matter when or where it was produced.

By eliminating mismatch problems, there is no costly and complicated belt matching to get a drive back on line; no problems with belts that are too tight or too loose.

Applications

For shock load applications. Ideal for pulsating loads, high-capacity drives and short center heavy-duty drives.

Key features & benefits

- > Classical profile ribs.
- > Joined construction for problem drives.
- > High-strength Vytacord® tensile members.
- > Available in cut-edge or envelope construction with fiber-loaded cushion.
- > Tough fabric backing.
- > Heat, ozone and abrasion resistant.
- > Matchmaker® to eliminate mismatch.
- > Static conductive.*

To learn more, visit www.contitech.us.

*Drive conditions and service variables in combination with time in operation can result in a loss of static conductivity. It is recommended that a conductivity check be added to drive preventive maintenance programs where belt static conductivity is a requirement.

HY-T® Wedge Torque Team® Classical Belts

Cross Sections and Lengths Available

Envelope 5V, 8V Cross Section



Cut Edge 3VX, 5VX Cross Section



Cut Edge Side View



Part #	Max. # of Ribs Per Slab	Part #	Max. # of Ribs Per Slab	Part #	Max. # of Ribs Per Slab	Part #	Max. # of Ribs Per Slab
B Profile							
BX35	49	BX65	49	BX90	49	B112	38
BX38	49	BX66	49	BX93	49	B114	38
BX42	49	BX67	49	BX95	49	B115	38
BX43	49	BX68	49	BX96	49	B116	38
BX46	49	BX70	49	BX97	49	B118	38
BX48	49	BX71	49	BX99	49	B140	38
BX50	49	BX72	49	BX100	49	B144	38
BX51	49	BX73	49	BX103	49	B148	38
BX52	49	BX74	49	BX105	49	B150	38
BX53	49	BX75	49	BX108	49	B158	38
BX54	49	BX77	49	BX112	49	B162	38
BX55	49	BX78	49	BX120	49	B173	38
BX56	49	BX79	49	BX124	49	B180	38
BX57	49	BX80	49	BX128	49	B195	38
BX58	49	BX81	49	BX133	49	B210	38
BX59	49	BX82	49	BX136	49	B225	38
BX60	49	BX83	49	*B55	49	B240	38
BX61	49	BX84	49	*B56	49	B255	38
BX62	49	BX85	49	B96	38	B270	38
BX63	49	BX87	49	B103	38	B300	38
BX64	49	BX88	49	B105	38	B315	38
C Profile							
CX60	36	CX109	36	C112	26	C270	26
CX68	36	CX112	36	C144	26	C285	26
CX75	36	CX120	36	C158	26	C300	26
CX81	36	CX124	36	C162	26	C315	26
CX85	36	CX128	36	C173	26	C330	26
CX90	36	CX136	36	C180	26	C345	26
CX96	36	C85	26	C195	26	C360	26
CX99	36	C90	26	C210	26	C390	26
CX100	36	C96	26	C225	26	C420	26
CX105	36	C105	26	C240	26		
CX108	36	C109	26	C255	26		
D Profile							
D120	10	D210	18	D315	18	D480	18
D144	18	D225	18	D330	18	D540	18
D158	18	D240	18	D345	18	D600	18
D162	18	D255	18	D360	18	D660	18
D173	18	D270	18	D390	18		
D180	18	D285	18	D420	18		
D195	18	D300	18	D450	18		

*Cut edge, non-cogged.

Poly-V® Belts

One belt that can do the work of many

The Poly-V® belt is a single, endless belt with longitudinal V-shaped ribs that mate consistently with the V-grooves in the sheaves. It combines the convenience of a thin, one-piece flat belt with the strong gripping traction of multiple V-belts to make the Poly-V® belt far better than either for many applications.

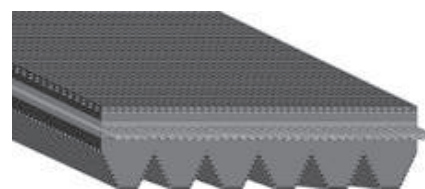

Part Number: 180J6

18.0"	Nominal outside length
J	J section Poly-V®
6	6 ribs

One continuous tension member for matchless performance

To distribute the drive load evenly across the full width of the sheave, the Poly-V® belt is built as a single unit with a completely supported, uninterrupted tension member. There is no matching problem. No separate belts to turn over, grab, slip or interfere with each other.

The thin cross-section profile allows use of smaller pulleys than standard V-belts and Poly-V® belts handle speed ratios of 40:1. With all this capacity, the Poly-V® belt tracks properly without special guides, flanges, crowns or deep grooves. And it resists seating in the grooves, so speed ratios remain more consistent and output speed remains more uniform.

More power in less space

Continuous engagement with the sheave driving surface gives you greater power capacity per inch of width. In addition, wasted space between separate V-belts is eliminated and converted into narrower, shallower grooves. These provide substantially greater contact area for stronger and more uniform traction.

Longer belt and sheave life

Complete support of the tension member, combined with full and uniform engagement with the sheave grooves, eliminates differential driving and equalizes belt stresses. That, in turn, minimizes belt elongation and leads to significantly longer flex life.

Even distribution of stress on the belt also reduces differential loading and wear on sheaves. It is not unusual for Poly-V® belt sheaves to last significantly longer than standard V-belt sheaves and to experience lower maintenance requirements during this longer life.

Improve drive design while you reduce drive cost

The combination of high-power capacity and low-profile design means the Poly-V® drive can improve the drive design while lowering drive costs.

Poly-V® belts allow narrower mounting clearances, need less center distance adjustment and require less take-up for tensioning. Additionally, they allow the use of sheaves that are narrower in width and smaller in diameter without sacrificing power capacity. Smaller, narrower sheaves mean a reduction in weight so more of the drive gets to the load for increased efficiency.

Applications

For small sheave compact designs requiring limited vibration. Ideal for high-speed ratio drives with short center distances.

- › Exercise equipment
- › Medical equipment
- › Farm equipment
- › Automobiles
- › Power equipment
- › Machine tools

Key features & benefits

- › Multiple V-ribbed profile provides friction and wedge advantages.
- › High-grade engineered rubber.
- › Strong Vytacord® tensile member.
- › L & M cross sections are milled in shorter lengths and molded in longer lengths.
- › Heat, ozone and abrasion resistant.

To learn more, visit www.contitech.us.

Poly-V® Belts

Cross Sections and Lengths Available

H and K sections are nonstock. Standard factory lead times will apply. Minimums apply. Contact your PTP Industrial Distributor.

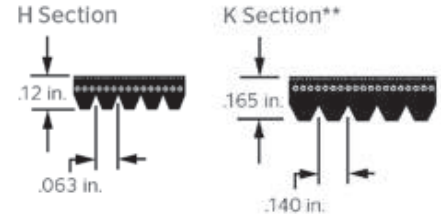

Stock construction: no minimum quantity required. Can order any number of ribs up to maximum number of ribs per belt (Max. # of Ribs Per Belt) shown below.

Part #	Max. # of Ribs Per Belt	Part #	Max. # of Ribs Per Belt	Part #	Max. # of Ribs Per Belt
J Section					
180J	68	520J	68	328J*	145
190J	68	550J	68	353J*	145
200J	68	580J	68	420J*	145
220J	68	610J	68	444J*	68
240J	68	650J	68	552J*	68
260J	68	730J	68	546J*	68
280J	68	870J	68	575J*	145
300J	68	920J	68	640J*	68
320J	68	980J	68	690J*	145
340J	68	100J*	40	770J*	145
360J	68	105J*	40	776J*	68
369J	68	110J*	40	810J*	145
380J	68	120J*	40	878J*	145
400J	68	140J*	46	890J*	68
410J	68	147J*	45	895J*	145
430J	68	204J*	68	904J*	145
460J	68	210J*	68	940J*	145
470J	68	230J*	70	994J*	145
480J	68	243J*	68	1000J*	145
490J	68	270J*	68	1200J*	145
500J	68	310J*	145		

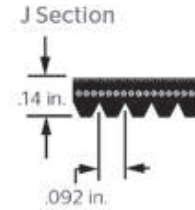

*Special note: special manufacture belts are available. Please check factory for availability.

**Drive conditions and service variables in combination with time in operation can result in a loss of static conductivity. It is recommended that a conductivity check be added to drive preventive maintenance programs where belt static conductivity is a requirement.

Stock construction: No minimum quantity required. Can order any number of ribs up to maximum number of ribs per belt (Max. # of Ribs Per Belt) shown below.

Part #	Max. # of Ribs Per Belt	Part #	Max. # of Ribs Per Belt	Part #	Max. # of Ribs Per Belt
L Section					
500L	96	840L	96	1455L	72
540L	96	865L	96	385L*	96
560L	96	915L	96	455L*	96
615L	96	975L	96	505L*	72
635L	96	990L	96	622L*	96
655L	96	1065L	96	748L*	96
675L	96	1120L	96	770L*	96
695L	96	1150L	96	845L*	96
725L	96	1180L	96	880L*	96
765L	96	1215L	96	1073L*	96
780L	96	1230L	96	1098L*	72
795L	96	1295L	96	1180L*	96
815L	96	1310L	96		
M Section					
900M	36	1470M	74	2560M	74
940M	36	1550M	74	2710M	74
990M	36	1610M	74	3010M	74
1060M	36	1650M	74	3310M	74
1115M	36	1760M	74	3610M	74
1150M	36	1830M	74	3910M	74
1185M	36	1980M	74	4210M	74
1230M	36	2130M	74	4810M	74
1310M	74	2250M	74		
1390M	74	2410M	74		

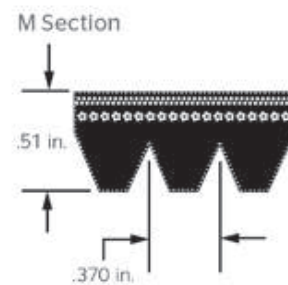
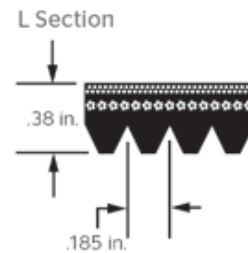

*Special note: Special manufacture belts are available. Please check factory for availability.

V-Belts

Not only traditional Classical and Narrow profiled belts, but also Double-V and FHP belts

When synchronization or timing is not required, V-belts make an excellent low-cost, quiet and efficient means of transmitting power. However, not all V-belts perform the same. Depending on your application and your objectives, some V-belts will be better at getting you closer to your end goal.

Narrow V-belts

Effectively handling drives from 1 to 1,000 horsepower, these belts rank high in horsepower-hours per dollar, the ultimate measure of drive value. The Narrow belt cross sections (3V, 5V and 8V), offer higher power capacity for any sheave size and weight.

The Narrow or "wedge" design provides more tensile member support than Classical V-belts. Narrow belts handle an equivalent load, but with narrower face width and smaller diameters than the traditional Classical V-belts. These features allow the use of smaller belts or fewer belts to transmit the load, an important advantage if your goal is to maximize power transmission efficiency by reducing drive weight and size.

Classic V-belts

The most widely used V-belts are A, B, C and D Classical belts. Used more out of habit and convenience than design, these belts can handle fractional to 500 horsepower drives, usually at the lowest cost. However, they occupy more space and the drives weigh more than Narrow belt drives. Also, Classical belts are usually less efficient than Narrow belts. But their versatility and wide range of sizes and types make them an attractive alternative to wedge belts.

Many Classical belts are used for replacement because it is considered too costly to replace sheaves when upgrading from Classical to Narrow or other belt types. Therefore, when replacing Classical sheaves, it is an opportune time to upgrade to Narrow or other belt types.

Specialty V-belts

When equipment calls for metric precision, you need a belt that not only measures up, but one that won't get lost in translation. Metric belts are engineered to universal metric profiles, but manufactured by Continental ContiTech in North America, so you do not have to go elsewhere to get them.

Strong, flexible and able to work in wide temperature ranges, metric belts replaces many common metric cross section belts such as XPZ, XPA, SPA, XPB, SPB, XPC and SPC.

Double-V or Hex belts

A variation of the Classical belt, Hex belts come in AA, BB, CC or a deep CCP cross section. These belts transfer power from either side in serpentine drives. A drive design using Hex belts is more complicated and engineering manuals should be consulted when replacing or troubleshooting these drives.

Fractional Horsepower belts (FHP)

The 3L, 4L and 5L light-duty FHP belts are part of the V-belt line also. As the name implies, these belts are used solely on drives of 1 horsepower or less.

Cogged, raw-edge construction vs. envelope construction

Continental ContiTech provide a complete offering of cogged, raw-edge belts in Narrow, Classical and FHP styles. Designated 3VX, 5VX, AX, BX, CX, 4L and 5L, cogged, raw-edge V-belts have higher capacity and efficiency and they use smaller sheaves than traditional envelope (wrapped) belts. These belts have a higher coefficient of friction and are more aggressive, which makes them a very efficient belt for power transmission.

Unlike conventional fabric-covered V-belts, raw-edge belts have no cover. Thus, the cross-sectional area normally occupied by the cover is used for more load-carrying cord. Cogs on the inner surface of the belt increase air flow to enhance cooler running. They also increase flexibility, allowing the belt to operate with smaller sheaves. With Classical V-belts, certain under-designed or problem drives can be upgraded to "satisfactory" by substituting Classical cogged belts for Classical envelope belts without replacing sheaves.

Because of their higher coefficient of friction, cogged belts tend to be more sensitive to alignment. While envelope belts can tolerate some misalignment, cogged belts are more likely to turn over under the same conditions. Cogged belts should not be used in clutching drives, drives with severe shock loads and drives that have changing center distances, such as shaker screens. In these applications, the aggressive nature and flexibility of cogged belts can cause vibration, belt turnover and belt breakage. Cogged belts should also be avoided in drives that require slippage during frequent stops and starts.

Wedge TLP™ Narrow V-Belts

Better belt performance is now within reach

Introducing the newest, longest-lasting narrow V-belt in the Continental ContiTech lineup.

WedgeTLP™



Part Number: 3VT950

3VT	0.38 in. top width - Narrow profile
950	95 in. nominal outside length
	Envelope uncogged construction shown

Constructed with a homogenous, one-piece design, the Wedge TLP™ Narrow V-belt delivers total lasting performance that is virtually maintenance free. Its high-modulus, high-denier cord can handle a significant increase in horsepower over our current HY-T® Wedge.

Little maintenance with no worries

Wedge TLP™'s unique advanced construction process includes use of a specialized reinforcement and compounds that make this Narrow V-belt virtually maintenance free. Install this belt the first time with proper installation techniques and take advantage of reduced downtime and maintenance.

Increase savings by using fewer belts

With its greater horsepower capacity, Wedge TLP™ allows you to deliver the same amount of horsepower with a lesser number of belts. Fewer belts mean fewer sheave grooves; the combination of the two means lower-cost belt drives.

Durability that goes the distance

Wedge TLP™ belts offer supreme durability and wear resistance - plus better fit even in worn sheaves. That is all because of its two envelope plies and specialty blended, fiber-rich compounding that help support increased horsepower, with less deformation under tension.

Applications

Premium, longer-life narrow-profile belts for compact, high-horsepower drives. Excellent in short-centered drives or where high shock loads are present; can be used any place you find traditional Narrow V-belts, but require a more robust composition for improved service life.

Key features & benefits

- > Homogenous design.
- > Specialty blended, fiber rich compounding.
- > Higher modulus, higher denier cord.
- > Virtually no maintenance.
- > Static conductive* with oil-resistant surface, for greater peace of mind.
- > Supreme durability and wear resistance.

*Drive conditions and service variables in combination with time in operation can result in a loss of static conductivity. It is recommended that a conductivity check be added to drive preventive maintenance programs where belt static conductivity is a requirement.

Wedge TLP™ Narrow V-Belts

Cross Sections and Lengths Available

Part #	Effective Length (in.)	Part #	Effective Length (in.)	Part #	Effective Length (in.)
3VT					
3VT500	50.0	3VT750	75.0	3VT1120	112.0
3VT530	53.0	3VT800	80.0	3VT1180	118.0
3VT560	56.0	3VT850	85.0	3VT1250	125.0
3VT600	60.0	3VT900	90.0	3VT1320	132.0
3VT630	63.0	3VT950	95.0	3VT1400	140.0
3VT670	67.0	3VT1000	100.0		
3VT710	71.0	3VT1060	106.0		
5VT					
5VT530	53.0	5VT1000	100.0	5VT1900	190.0
5VT560	56.0	5VT1060	106.0	5VT2000	200.0
5VT600	60.0	5VT1120	112.0	5VT2120	212.0
5VT630	63.0	5VT1180	118.0	5VT2240	224.0
5VT670	67.0	5VT1250	125.0	5VT2360	236.0
5VT710	71.0	5VT1320	132.0	5VT2500	250.0
5VT750	75.0	5VT1400	140.0	5VT2650	265.0
5VT800	80.0	5VT1500	150.0	5VT2800	280.0
5VT850	85.0	5VT1600	160.0	5VT3000	300.0
5VT900	90.0	5VT1700	170.0	5VT3150	315.0
5VT950	95.0	5VT1800	180.0		
8VT					
8VT1000	100.0	8VT1800	180.0	8VT3000	300.0
8VT1120	112.0	8VT1900	190.0	8VT3150	315.0
8VT1180	118.0	8VT2000	200.0	8VT3350	335.0
8VT1250	125.0	8VT2120	212.0	8VT3550	355.0
8VT1320	132.0	8VT2240	224.0	8VT3750	375.0
8VT1400	140.0	8VT2360	236.0	8VT4000	400.0
8VT1500	150.0	8VT2500	250.0	8VT4250	425.0
8VT1600	160.0	8VT2650	265.0	8VT4500	450.0
8VT1700	170.0	8VT2800	280.0		

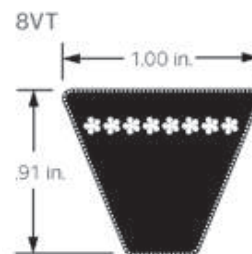
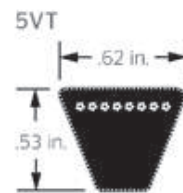
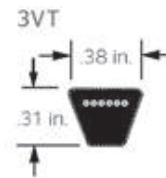

HY-T® Wedge Belts

A narrower cross section and stronger construction reduces drive costs



Part Number: 5V1400

5V	0.62 in. top width - Narrow profile
1400	140 in. nominal outside length
	Envelope uncogged construction shown

The savings start in the basic wedge or narrow design of the HY-T® Wedge belt. It has a narrower cross section than standard V-belts so it distributes stresses more uniformly to deliver more consistent, more reliable power transmission.

A wedge cross-section means the belts are narrower and weigh less. Narrower belts allow for the use of thinner and lighter sheaves, resulting in a more efficient drive.

The savings continue through the higher horsepower capacity provided by Continental ContiTech HY-T® V-belt construction. Vytacord® tension members provide strength and dimensional stability. Higher horsepower capacity is also provided through a tough engineered rubber compound cushion, adding to belt strength.

HY-T® Wedge, with its narrow cross-section, makes it possible to achieve a required horsepower with fewer HY-T® Wedge belts than with standard V-belts, reducing sheave size, sheave costs and belt costs even more.

Since less power is required to run the smaller, lighter drives, more power gets to the load. Therefore, you may be able to downsize drive motors and/or increase drive efficiency for even more savings.

Matchmaker® performance

HY-T® Wedge belts eliminate mismatch problems as each Matchmaker® belt is mirrored in size and performance to every other HY-T® Wedge belt in that size, no matter when or where it was produced.

Cut-edge or envelope constructions provide optimum performance

HY-T® Wedge belts are produced with a highly engineered EPDM compound available in a cut-edge cogged construction for increased flexibility and heat dissipation with a broader temperature range than ever before (-40F to 230F/-40C to 110C). This belt can handle extremely high temperatures and is also available in envelope construction for drives where pulsation shock loads, high tension and long centers are involved.

HY-T® Wedge Cogged belts are high-horsepower belt constructions that are identified with a 3VX and 5VX prefix and are available in lengths up to 200 inches. The cogged construction provides the high flexibility required for short center distances. The cogs also provide a larger surface area to dissipate heat and prolong belt life. Improved material properties and advanced construction technology results in an average horsepower increase of 30% over standard "Classical" V-belt and wedge belts.

HY-T® Wedge envelope belts are identified with a 3V, 5V or 8V prefix and are recommended for drives where pulsation, shock loads, high tension and long centers are involved. It features a continuous V-section that is protected by a wide angle, synthetic fabric impregnated with high-quality engineered rubber compound. This unique envelope achieves the high strength HY-T® Wedge belts need to withstand high loading forces. It also provides the torsional rigidity required in long center drives delivering the traction needed for accurate tracking and precision performance.

Applications

Narrow profile belts for compact, high horsepower drives, high shock loading on short centers and small diameters. For designing compact, heavy-duty drives where space limitation is a factor.

Key features & benefits

- › Narrow profile provides savings through efficiency.
- › Greater horsepower than the Classical belt.
- › Strong Vytacord® (polyester) tensile members.
- › High-grade engineered rubber.
- › Heat, ozone and abrasion resistant.
- › Available in raw-edge construction with cogs or envelope construction.
- › Matchmaker® to eliminate mismatch.
- › Static conductive.*
- › Operates in a wide ambient temperature range (-40°F to 230°F/-40°C to 110°C).
- › EPDM construction (cut-edge cogged only).

*Drive conditions and service variables in combination with time in operation can result in a loss of static conductivity. It is recommended that a conductivity check be added to drive preventive maintenance programs where belt static conductivity is a requirement.

Cross Sections and Lengths Available

Cogged Sizes*

Part #	Effective Length (in.)	Part #	Effective Length (in.)	Part #	Effective Length (in.)
3VX					
3VX250	25.0	3VX450	45.0	3VX850	85.0
3VX265	26.5	3VX475	47.5	3VX900	90.0
3VX280	28.0	3VX500	50.0	3VX950	95.0
3VX300	30.0	3VX530	53.0	3VX1000	100.0
3VX315	31.5	3VX560	56.0	3VX1060	106.0
3VX335	33.5	3VX600	60.0	3VX1120	112.0
3VX350	35.0	3VX630	63.0	3VX1180	118.0
3VX355	35.5	3VX650	65.0	3VX1250	125.0
3VX360	36.0	3VX670	67.0	3VX1320	132.0
3VX375	37.5	3VX710	71.0	3VX1400	140.0
3VX400	40.0	3VX750	75.0	3VX1500	150.0
3VX425	42.5	3VX800	80.0		
5VX					
5VX450	45.0	5VX690	69.0	5VX1030	103.0
5VX470	47.0	5VX710	71.0	5VX1060	106.0
5VX490	49.0	5VX730	73.0	5VX1080	108.0
5VX500	50.0	5VX740	74.0	5VX1120	112.0
5VX510	51.0	5VX750	75.0	5VX1150	115.0
5VX530	53.0	5VX780	78.0	5VX1180	118.0
5VX540	54.0	5VX800	80.0	5VX1230	123.0
5VX550	55.0	5VX810	81.0	5VX1250	125.0
5VX560	56.0	5VX830	83.0	5VX1277	122.7
5VX570	57.0	5VX840	84.0	5VX1320	132.0
5VX580	58.0	5VX850	85.0	5VX1400	140.0
5VX590	59.0	5VX860	86.0	5VX1500	150.0
5VX600	60.0	5VX880	88.0	5VX1600	160.0
5VX610	61.0	5VX900	90.0	5VX1700	170.0
5VX630	63.0	5VX930	93.0	5VX1800	180.0
5VX650	65.0	5VX950	95.0	5VX1900	190.0
5VX660	66.0	5VX960	96.0	5VX2120	212.0
5VX670	67.0	5VX1000	100.0		
5VX680	68.0	5VX1017	101.7		
8VX					
8VX1000	100.0	8VX1320	132.0	8VX1800	180.0
8VX1060	106.0	8VX1400	140.0	8VX1900	190.0
8VX1120	112.0	8VX1500	150.0	8VX2000	200.0
8VX1180	118.0	8VX1600	160.0		
8VX1250	125.0	8VX1700	170.0		

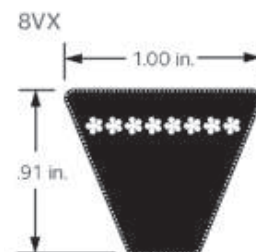
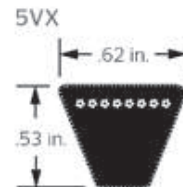
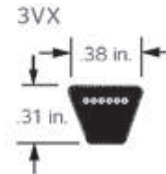

*Cut-edge cogged construction. EPDM -40°F to 230°F (-40°C to 110°C) temperature range.

HY-T® Wedge Belts

Cross Sections and Lengths Available

Noncogged Sizes

Part #	Effective Length (in.)	Part #	Effective Length (in.)	Part #	Effective Length (in.)
3V					
3V250	25.0	3V475	47.5	3V900	90.0
3V265	26.5	3V500	50.0	3V950	95.0
3V280	28.0	3V530	53.0	3V1000	100.0
3V300	30.0	3V560	56.0	3V1060	106.0
3V315	31.5	3V600	60.0	3V1120	112.0
3V335	33.5	3V630	63.0	3V1180	118.0
3V355	35.5	3V670	67.0	3V1250	125.0
3V375	37.5	3V710	71.0	3V1320	132.0
3V400	40.0	3V750	75.0	3V1400	140.0
3V425	42.5	3V800	80.0		
3V450	45.0	3VX850	85.0		
5V					
5V500	50.0	5V1060	106.0	5V2000	200.0
5V560	56.0	5V1120	112.0	5V2120	212.0
5V630	63.0	5V1180	118.0	5V2240	224.0
5V670	67.0	5V1250	125.0	5V2360	236.0
5V710	71.0	5V1320	132.0	5V2500	250.0
5V750	75.0	5V1400	140.0	5V2650	265.0
5V800	80.0	5V1500	150.0	5V2800	280.0
5V850	85.0	5V1600	160.0	5V3000	300.0
5V900	90.0	5V1700	170.0	5V3150	315.0
5V950	95.0	5V1800	180.0	5V3350	335.0
5V1000	100.0	5V1900	190.0	5V3550	355.0
8V					
8V1000	100.0	8V1800	180.0	8V3150	315.0
8V1060	106.0	8V1900	190.0	8V3350	335.0
8V1120	112.0	8V2000	200.0	8V3550	355.0
8V1180	118.0	8V2120	212.0	8V3750	375.0
8V1250	125.0	8V2240	224.0	8V4000	400.0
8V1320	132.0	8V2360	236.0	8V4250	425.0
8V1400	140.0	8V2500	250.0	8V4500	450.0
8V1500	150.0	8V2650	265.0	8V4750	475.0
8V1600	160.0	8V2800	280.0	8V5000	500.0
8V1700	170.0	8V3000	300.0	8V5600	560.0

HY-T® Plus (Classical) Belts

Less elongation is the key to performance

Whether you are talking about rubber belts or metal chains, most materials will elongate when put to use. The secret to reliable performance is not to eliminate elongation, but to control it so that it is minimal, predictable and uniform. To achieve these criteria, we developed the Vytacord® tensile member.



Part Number: B75

B	0.66 in. top width - Classical profile
75	Approximate 75 in. inside length

Vytacord® provides the high-strength, high-horsepower rating capacity needed to effectively transmit today's drive power. It is even tough enough to tolerate slight sheave misalignment that would quickly destroy ordinary belts.

The Vytacord® tensile member provides dimensional stability. As a result, each belt of a given size will maintain its length consistency, no matter when or where it was produced.

The exceptional dimensional stability properties of HY-T® Plus eliminates matching problems, improves performance and increases service life.

Improved materials are the key to the durability and versatility of HY-T® Plus

The vast improvements in all components of HY-T® Plus construction complement the quality of the Vytacord® tensile member.

Our engineered heat- and oil-resistant rubber compound is used in both the cushion and insulation sections of HY-T® Plus. Belt construction provides the flexibility on small pulleys. As a result the belt is able to serve a dual purpose for both Classical and FHP, while offering more versatility than any other Classical belt.

The HY-T® Plus envelope construction assures optimum wrap and fill thread angle, providing belt flexibility. In addition, the fabric is treated with Continental ContiTech exclusive engineered rubber compound for long wear and resistance to heat, oil and other environmental hazards. The envelope also assures that the belt dissipates static electricity, as specified in ARPM bulletin IP3-3.

The cushion is also crush-resistant and cool running to maintain its shape, fit and strength longer. And with the longer service

life achieved by HY-T® Plus belts, replacement of belts is less frequent. Overall, belt costs are reduced, downtime is minimized and equipment productivity is maintained.

Less inventory required

The HY-T® Plus can be used in FHP applications. Conversely, rarely do FHP belts perform in HY-T® Plus (Classical) applications.

The result is a reduced inventory that equates to dollars taken off the shelves and into your pockets.

Applications

Designed for operating at high speeds over small diameter pulleys and short center distances. Also for use in multiple V-belt drives where high shock load and heavy-duty loads are encountered.

Key features & benefits

- > Universal Classical profile.
- > High-strength Vytacord® tensile members.
- > Engineered rubber-impregnated envelope.
- > Engineered rubber compound cushion and insulation.
- > Dual branded (Classical and FHP part numbers).
- > Oil, heat, ozone and abrasion resistant.
- > Matchmaker® to eliminate mismatch.
- > Static conductive.*

To learn more, visit www.contitech.us.

*Drive conditions and service variables in combination with time in operation can result in a loss of static conductivity. It is recommended that a conductivity check be added to drive preventive maintenance programs where belt static conductivity is a requirement.

HY-T® Plus (Classical) Belts

Cross Sections and Lengths Available

A Section

Part #	Approx. Outside Length (in.)	Part #	Approx. Outside Length (in.)	Part #	Approx. Outside Length (in.)
A20 (4L220)	22	A51 (4L530)	53	A82 (4L840)	84
A21 (4L230)	23	A52 (4L540)	54	A83 (4L850)	85
A22 (4L240)	24	A53 (4L550)	55	A84 (4L860)	86
A23 (4L250)	25	A54 (4L560)	56	A85 (4L870)	87
A24 (4L260)	26	A55 (4L570)	57	A86 (4L880)	88
A25 (4L270)	27	A56 (4L580)	58	A87 (4L890)	89
A26 (4L280)	28	A57 (4L590)	59	A88 (4L900)	90
A27 (4L290)	29	A58 (4L600)	60	A89 (4L910)	91
A28 (4L300)	30	A59 (4L610)	61	A90 (4L920)	92
A29 (4L310)	31	A60 (4L620)	62	A91 (4L930)	93
A30 (4L320)	32	A61 (4L630)	63	A92 (4L940)	94
A31 (4L330)	33	A62 (4L640)	64	A93 (4L950)	95
A32 (4L340)	34	A63 (4L650)	65	A94 (4L960)	96
A33 (4L350)	35	A64 (4L660)	66	A95 (4L970)	97
A34 (4L360)	36	A65 (4L670)	67	A96 (4L980)	98
A35 (4L370)	37	A66 (4L680)	68	A97 (4L990)	99
A36 (4L380)	38	A67 (4L690)	69	A98 (4L1000)	100
A37 (4L390)	39	A68 (4L700)	70	A100 (4L1020)	102
A38 (4L400)	40	A69 (4L710)	71	A103	105
A39 (4L410)	41	A70 (4L720)	72	A105	107
A40 (4L420)	42	A71 (4L730)	73	A110	112
A41 (4L430)	43	A72 (4L740)	74	A112	114
A42 (4L440)	44	A73 (4L750)	75	A120	122
A43 (4L450)	45	A74 (4L760)	76	A128	130
A44 (4L460)	45	A75 (4L770)	77	A133	135
A45 (4L470)	47	A76 (4L780)	78	A136	138
A46 (4L480)	48	A77 (4L790)	79	A144	146
A47 (4L490)	49	A78 (4L800)	80	A158	160
A48 (4L500)	50	A79 (4L810)	81	A173	175
A49 (4L510)	51	A80 (4L820)	82	A180	182
A50 (4L520)	52	A81 (4L830)	83		

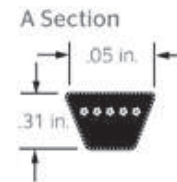

B Section

Part #	Approx. Outside Length (in.)	Part #	Approx. Outside Length (in.)	Part #	Approx. Outside Length (in.)
B22 (5L250)	25	B62 (5L650)	65	B103	106
B23 (5L260)	26	B63 (5L660)	66	B104	107
B24 (5L270)	27	B64 (5L670)	67	B105	108
B25 (5L280)	28	B65 (5L680)	68	B108	111
B26 (5L290)	29	B66 (5L690)	69	B111	114
B27 (5L300)	30	B67 (5L700)	70	B112	115
B28 (5L310)	31	B68 (5L710)	71	B115	118
B29 (5L320)	32	B69 (5L720)	72	B116	119
B30 (5L330)	33	B70 (5L730)	73	B118	121
B31 (5L340)	34	B71 (5L740)	74	B120	123
B32 (5L350)	35	B72 (5L750)	75	B124	127
B33 (5L360)	36	B73 (5L760)	76	B126	129
B34 (5L370)	37	B74 (5L770)	77	B128	131
B35 (5L380)	38	B75 (5L780)	78	B133	136
B36 (5L390)	39	B76 (5L790)	79	B136	139
B37 (5L400)	40	B77 (5L800)	80	B140	143
B38 (5L410)	41	B78 (5L810)	81	B144	147
B39 (5L420)	42	B79 (5L820)	82	B148	151
B40 (5L430)	43	B80 (5L830)	83	B150	153
B41 (5L440)	44	B81 (5L840)	84	B154	157
B42 (5L450)	45	B82 (5L850)	85	B158	161
B43 (5L460)	46	B83 (5L860)	86	B162	165
B44 (5L470)	47	B84 (5L870)	87	B173	176
B45 (5L480)	48	B85 (5L880)	88	B180	183
B46 (5L490)	49	B86 (5L890)	89	B190	193
B47 (5L500)	50	B87 (5L900)	90	B195	198
B48 (5L510)	51	B88 (5L910)	91	B205	208
B49 (5L520)	52	B89 (5L920)	92	B210	213
B50 (5L530)	53	B90 (5L930)	93	B225	227
B51 (5L540)	54	B91 (5L940)	94	B240	242
B52 (5L550)	55	B92 (5L950)	95	B255	257
B53 (5L560)	56	B93 (5L960)	96	B270	272
B54 (5L570)	57	B94 (5L970)	97	B285	287
B55 (5L580)	58	B95 (5L980)	98	B300	302
B56 (5L590)	59	B96 (5L990)	99	B315	317
B57 (5L600)	60	B97 (5L1000)	100	B330	332
B58 (5L610)	61	B98 (5L1010)	101	B360	362
B59 (5L620)	62	B99 (5L1020)	102	B394	396
B60 (5L630)	63	B100	103		
B61 (5L640)	64	B101	104		

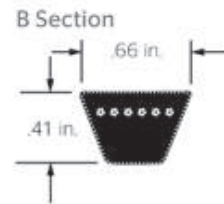

HY-T® Plus (Classical) Belts

Cross Sections and Lengths Available

C Section

Part #	Approx. Outside Length (in.)	Part #	Approx. Outside Length (in.)	Part #	Approx. Outside Length (in.)
C48	52	C103	107	C173	177
C50	54	C105	109	C180	184
C51	55	C106	110	C190	194
C55	59	C108	112	C195	199
C60	64	C109	113	C210	214
C62	66	C110	114	C225	227
C68	72	C112	116	C240	242
C71	75	C115	119	C255	257
C72	76	C120	124	C270	272
C75	79	C124	128	C285	287
C78	82	C128	132	C300	302
C80	84	C136	140	C315	317
C81	85	C144	148	C330	332
C85	89	C148	152	C345	347
C90	94	C150	154	C360	362
C93	97	C156	160	C390	392
C94	98	C158	162	C420	422
C100	104	C162	166		
C101	105	C165	169		

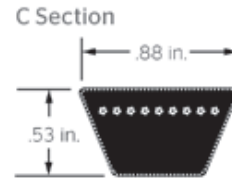

D Section

Part #	Approx. Outside Length (in.)	Part #	Approx. Outside Length (in.)	Part #	Approx. Outside Length (in.)
D112	117	D210	215	D345	348
D120	125	D225	228	D360	363
D128	133	D240	243	D390	393
D144	149	D255	258	D420	423
D158	163	D270	273	D450	453
D162	167	D285	388	D480	483
D173	178	D300	303	D540	543
D180	185	D315	318		
D195	200	D330	333		

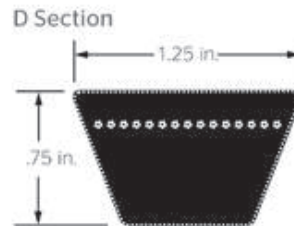

E Section

Part #	Approx. Outside Length (in.)	Part #	Approx. Outside Length (in.)	Part #	Approx. Outside Length (in.)
E180	187	E300	304	E480	484
E195	202	E330	334	E540	544
E210	217	E360	364	E600	604
E240	244	E390	394		
E270	274	E420	424		

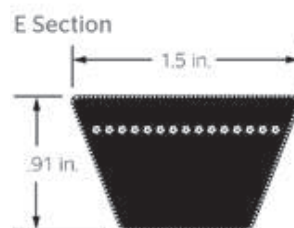

Torque-Flex® V-Belts

More horsepower per dollar

Your drives can deliver the horsepower you want at a lower component cost - and with lower energy costs - when you include Continental ContiTech Torque-Flex® V-belts in the design.



Part Number: BX75

B	0.66 in. top width - Classical profile
X	Premium cogged construction
75	Approximate 75 in. inside length Cut-edge, molded cog construction shown

Torque-Flex® V-belts are fully cogged to provide the flexibility needed to keep their high-traction rubber edges in contact with the sheave grooves. This high efficiency allows you to achieve the horsepower you need at a lower total drive cost.

Produced with a highly engineered EPDM compound, cut-edge cogged construction belts operate in a broader temperature range than ever before (-40°F to 230°F/-40°C to 110°C). Torque-Flex® V-belts can handle extremely high temperatures.

Exacting precision and uniformity

Rigid quality assurance programs imposed during Torque-Flex® V-belt manufacture result in belt angles and belt lengths which are more exact than standard belts. This results in quiet, smooth-running and long-lasting belts. Think what that can save in reduced downtime and belt maintenance.

Of course, with such exacting production requirements, our Torque-Flex® V-belts also achieve consistent uniformity from run to run. This outstanding consistency means you can be sure that two belts of the same size designation will match, no matter when they were produced. As a result:

- › You eliminate mismatching problems caused by individual belts that may be too loose or too tight.
- › You simplify ordering procedures - no lengthy specifications, detailing match-ups and sizing.
- › No complicated time-consuming matching. Your Continental ContiTech belts are automatically matched when you buy them.
- › You reduce your in-plant inventory. The Matchmaker® system covers your needs with a minimum of belts to save you space and inventory dollars.

More savings from fewer belts

The high-strength and high horsepower capacity of Torque-Flex® V-belts means you need fewer belts and fewer sheave grooves to deliver the same amount of horsepower.

Energy-saving efficiency

The same design and construction features which lead to high horsepower ratings for Torque-Flex® V-belts also lead to improvements in energy efficiency of up to 4%, depending on sheave diameter.

Applications

Designed for the tough, small sheave, high-tension drives.

Key features & benefits

- › Premium Classical profile construction.
- › 25%-30% higher power ratings than standard V-belts.
- › Strong Vytacord® (polyester) tensile members.
- › Engineered cushion compound.
- › Cut-edge cogged construction on most sizes.
- › Heat, ozone and abrasion resistant.
- › Matchmaker® to eliminate mismatch.
- › Static conductive.*
- › Operates in a wide ambient temperature range (-40°F to 230°F/-40°C to 110°C).
- › EPDM construction (cut-edge cogged only).

Cogged vs. Noncogged Belt Efficiency

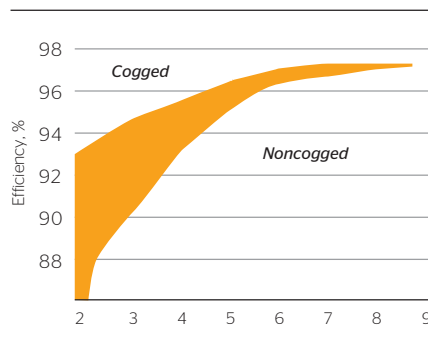

*Drive conditions and service variables in combination with time in operation can result in a loss of static conductivity. It is recommended that a conductivity check be added to drive preventive maintenance programs where belt static conductivity is a requirement.

Sheave Diameter (in.)
■ Belt Efficiency

Torque-Flex® V-Belts

Cross Sections and Lengths Available

Side View



AX*

Part #	Approx. Outside Length (in.)	Part #	Approx. Outside Length (in.)	Part #	Approx. Outside Length (in.)
AX21	23	AX49	51	AX76	78
AX22	24	AX50	52	AX77	79
AX23	25	AX51	53	AX78	80
AX24	26	AX52	54	AX79	81
AX26	28	AX53	55	AX80	82
AX27	29	AX54	56	AX81	83
AX28	30	AX55	57	AX82	84
AX29	31	AX56	58	AX83	85
AX30	32	AX57	59	AX84	86
AX31	33	AX58	60	AX85	87
AX32	34	AX59	61	AX86	88
AX33	35	AX60	62	AX87	89
AX34	36	AX61	63	AX88	90
AX35	37	AX62	64	AX89	91
AX36	38	AX63	65	AX90	92
AX37	39	AX64	66	AX91	93
AX38	40	AX65	67	AX93	95
AX39	41	AX66	68	AX94	96
AX40	42	AX67	69	AX95	97
AX41	43	AX68	70	AX96	98
AX42	44	AX69	71	AX97	99
AX43	45	AX70	72	AX98	100
AX44	46	AX71	73	AX100	102
AX45	47	AX72	74	AX103	105
AX46	48	AX73	75	AX105	107
AX47	49	AX74	76	AX110	112
AX48	50	AX75	77	AX112	114

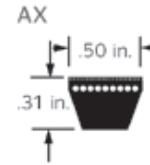

*Cut-edge cogged construction. EPDM -40°F to 230°F (-40°C to 110°C) temperature range.

Side View

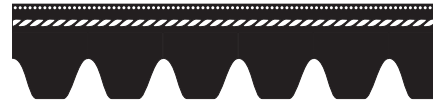

BX*

Part #	Approx. Outside Length (in.)	Part #	Approx. Outside Length (in.)	Part #	Approx. Outside Length (in.)
BX28	31	BX67	70	BX103	106
BX31	34	BX68	71	BX105	108
BX32	35	BX69	72	BX106	109
BX34	37	BX70	73	BX108	111
BX35	38	BX71	74	BX112	115
BX36	39	BX72	75	BX113	116
BX38	41	BX73	76	BX115	118
BX40	43	BX74	77	BX116	119
BX41	44	BX75	78	BX120	123
BX42	45	BX76	79	BX123	126
BX43	46	BX77	80	BX124	127
BX44	47	BX78	81	BX126	129
BX45	48	BX79	82	BX128	131
BX46	49	BX80	83	BX133	136
BX47	50	BX81	84	BX136	139
BX48	51	BX82	85	BX140	143
BX49	52	BX83	86	BX144	147
BX50	53	BX84	87	BX148	151
BX51	54	BX85	88	BX150	153
BX52	55	BX86	89	BX154	157
BX53	56	BX87	90	BX158	161
BX54	57	BX88	91	BX162	165
BX55	58	BX89	92	BX173	176
BX56	59	BX90	93	BX180	183
BX57	60	BX91	94	BX191	194
BX58	61	BX92	95	BX195	198
BX59	62	BX93	96	BX210	213
BX60	63	BX94	97	BX225	228
BX61	64	BX95	98	BX240	243
BX62	65	BX96	99	BX255	258
BX63	66	BX97	100	BX270	273
BX64	67	BX98	101	BX300	303
BX65	68	BX99	102		
BX66	69	BX100	103		

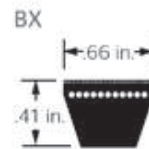

*Cut-edge cogged construction. EPDM -40°F to 230°F (-40°C to 110°C) temperature range.

Torque-Flex® V-Belts

Cross Sections and Lengths Available

CX*

Part #	Approx. Outside Length (in.)	Part #	Approx. Outside Length (in.)	Part #	Approx. Outside Length (in.)
CX51	55	CX100	104	CX150	154
CX55	59	CX101	105	CX158	162
CX60	64	CX105	109	CX162	166
CX68	72	CX109	113	CX173	177
CX72	76	CX111	115	CX180	184
CX75	79	CX112	116	CX195	199
CX78	82	CX115	119	CX210	214
CX81	85	CX120	124	CX240	244
CX85	89	CX128	132	CX270	274
CX90	94	CX136	140		
CX96	100	CX144	148		

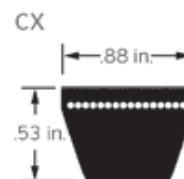

*Cut-edge cogged construction. EPDM -40°F to 230°F (-40°C to 110°C) temperature range.

Metric Belts

Versatility

Metric belts operate under one of the widest temperature ranges in the industry, from -40°F to 230°F (-40°C to 110°C)*. It is that versatility and our experience in rubber compounding that can provide superior performance under the toughest conditions.

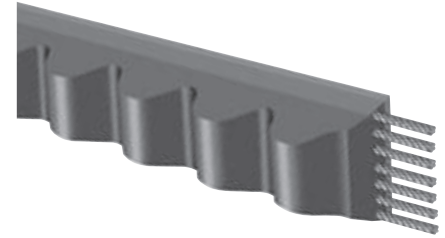

Part Number: XPA0707

X	Premium cogged construction
PA	Metric A profile
0707	707mm datum length

Universal fit

When equipment calls for metric precision, you need a belt that not only measures up, but one that will not get lost in translation. Metric belts are engineered to universal metric profiles, but manufactured by Continental ContiTech in North America, so you do not have to go elsewhere to get them.

Superior performance under tough conditions

Metric belts are strong, flexible and able to work within a wide temperature range, offering superior performance under the toughest conditions. So they do more than measure up. They stand apart.

Produced with a highly engineered EPDM compound, cut-edge cogged construction belts operate in a broader temperature range than ever before (-40°F to 230°F/-40°C to 110°C). Metric belts can handle extremely high temperatures.

More savings from fewer belts

The high-strength and high horsepower capacity of Metric V-belts means you need fewer belts and fewer sheave grooves to deliver the same amount of horsepower.

Applications

Specialty V-belt for a wide variety of heavy-duty, temperature-sensitive applications.

Key features & benefits

- › Wedge profile allows for a smaller drive package and lower operating costs.
- › Premium fiber loading adds strength and cord support.
- › Raw-edge, molded cog and envelope constructions.
- › Optimum wedging action provides maximum torque carrying performance.
- › Heat, ozone and abrasion resistant.
- › Static-conductive** for specialized applications.
- › Operates in a wide ambient temperature range (-40°F to 230°F/-40°C to 110°C).
- › EPDM construction (cut-edge cogged only).

*Temperature range is based upon test data obtained on select belt sizes manufactured from our latest rubber compounds, consistent with standard MIL-B-11040-E, section 3.8.

**Drive conditions and service variables in combination with time in operation can result in a loss of static conductivity. It is recommended that a conductivity check be added to drive preventive maintenance programs where belt static conductivity is a requirement.

Metric Belts

Cross Sections and Lengths Available

XPZ*

Part #	Datum Length (in.)	Part #	Datum Length (in.)	Part #	Datum Length (in.)
XPZ0487	19.17	XPZ1060	41.73	XPZ1650	64.96
XPZ0512	20.16	XPZ1077	42.40	XPZ1662	65.43
XPZ0562	22.13	XPZ1087	42.80	XPZ1687	66.42
XPZ0587	23.11	XPZ1112	43.78	XPZ1700	66.93
XPZ0612	24.09	XPZ1120	44.09	XPZ1737	68.39
XPZ0630	24.80	XPZ1137	44.76	XPZ1750	68.90
XPZ0637	25.08	XPZ1162	45.75	XPZ1762	69.37
XPZ0662	26.06	XPZ1171	46.10	XPZ1787	70.35
XPZ0670	26.38	XPZ1180	46.46	XPZ1800	70.87
XPZ0687	27.05	XPZ1187	46.73	XPZ1812	71.34
XPZ0710	27.95	XPZ1200	47.24	XPZ1837	72.32
XPZ0722	28.43	XPZ1202	47.32	XPZ1850	72.83
XPZ0737	29.02	XPZ1237	48.70	XPZ1862	73.31
XPZ0750	29.53	XPZ1250	49.21	XPZ1887	74.29
XPZ0762	30.00	XPZ1262	49.69	XPZ1900	74.80
XPZ0787	30.98	XPZ1270	50.00	XPZ1937	76.26
XPZ0800	31.50	XPZ1287	50.67	XPZ1950	76.77
XPZ0812	31.97	XPZ1312	51.65	XPZ1962	77.24
XPZ0825	32.48	XPZ1320	51.97	XPZ1987	78.23
XPZ0837	32.95	XPZ1337	52.64	XPZ2000	78.74
XPZ0850	33.46	XPZ1362	53.62	XPZ2030	79.92
XPZ0862	33.94	XPZ1387	54.61	XPZ2037	80.20
XPZ0875	34.45	XPZ1400	55.12	XPZ2060	81.10
XPZ0887	34.92	XPZ1412	55.59	XPZ2062	81.18
XPZ0900	35.43	XPZ1420	55.91	XPZ2075	81.69
XPZ0912	35.91	XPZ1437	56.57	XPZ2087	82.17
XPZ0922	36.30	XPZ1450	57.09	XPZ2120	83.46
XPZ0925	36.42	XPZ1462	57.56	XPZ2160	85.04
XPZ0927	36.50	XPZ1487	58.54	XPZ2187	86.10
XPZ0937	36.89	XPZ1500	59.06	XPZ2240	88.19
XPZ0950	37.40	XPZ1512	59.53	XPZ2280	89.76
XPZ0962	37.87	XPZ1520	59.84	XPZ2287	90.04
XPZ0975	38.39	XPZ1527	60.12	XPZ2360	92.91
XPZ0987	38.86	XPZ1537	60.51	XPZ2410	94.88
XPZ1000	39.37	XPZ1562	61.50	XPZ2487	97.91
XPZ1012	39.84	XPZ1587	62.48	XPZ2500	98.43
XPZ1024	40.31	XPZ1600	62.99	XPZ2540	100.00
XPZ1037	40.83	XPZ1612	63.46	XPZ2650	104.33
XPZ1047	41.22	XPZ1637	64.45	XPZ2800	110.24

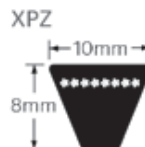

*Denotes cog construction. EPDM -40°F to 230°F (-40°C to 110°C) temperature range.

XPA*/SPA

Part #	Datum Length (in.)	Part #	Datum Length (in.)	Part #	Datum Length (in.)
XPA0707	27.83	XPA1450	57.09	XPA2082	81.97
XPA0732	28.82	XPA1457	57.36	XPA2120	83.46
XPA0757	29.80	XPA1482	58.35	XPA2132	83.94
XPA0782	30.79	XPA1500	59.06	XPA2182	85.91
XPA0850	33.46	XPA1507	59.33	XPA2207	86.89
XPA0857	33.74	XPA1525	60.04	XPA2240	88.19
XPA0872	34.33	XPA1532	60.31	XPA2282	89.84
XPA0882	34.72	XPA1550	61.02	XPA2300	90.55
XPA0900	35.43	XPA1557	61.30	XPA2360	92.91
XPA0922	36.30	XPA1582	62.28	XPA2432	95.75
XPA0982	38.66	XPA1600	62.99	XPA2482	97.72
XPA1000	39.37	XPA1607	63.27	XPA2500	98.43
XPA1007	39.65	XPA1632	64.25	XPA2532	99.69
XPA1032	40.63	XPA1657	65.24	XPA2580	101.57
XPA1057	41.61	XPA1682	66.22	XPA2582	101.65
XPA1060	41.73	XPA1700	66.93	XPA2607	102.64
XPA1082	42.60	XPA1707	67.20	XPA2632	103.62
XPA1120	44.09	XPA1732	68.19	XPA2650	104.33
XPA1157	45.55	XPA1750	68.90	XPA2682	105.59
XPA1180	46.46	XPA1757	69.17	XPA2732	107.56
XPA1207	47.52	XPA1782	70.16	XPA2782	109.53
XPA1220	48.03	XPA1800	70.87	XPA2800	110.24
XPA1232	48.50	XPA1807	71.14	XPA2832	111.50
XPA1250	49.21	XPA1832	72.13	XPA2882	113.46
XPA1257	49.49	XPA1850	72.83	XPA2900	114.17
XPA1282	50.47	XPA1857	73.11	XPA2982	117.40
XPA1300	51.18	XPA1882	74.09	XPA3000	118.11
XPA1307	51.46	XPA1900	74.80	XPA3150	124.02
XPA1320	51.97	XPA1907	75.08	XPA3182	125.28
XPA1325	52.17	XPA1932	76.06	XPA3350	131.89
XPA1332	52.44	XPA1957	77.05	XPA3382	133.15
XPA1357	53.43	XPA1982	78.03	SPA3550	139.76
XPA1382	54.41	XPA2000	78.74	SPA3650	143.70
XPA1400	55.12	XPA2032	80.00	SPA3882	152.83
XPA1407	55.39	XPA2057	80.98	SPA4000	157.48
XPA1432	56.38	XPA2060	81.10	SPA4500	177.17

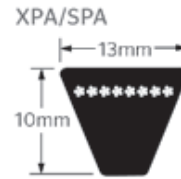

*Denotes cog construction. EPDM -40°F to 230°F (-40°C to 110°C) temperature range.

Metric Belts

Cross Sections and Lengths Available

XPB*/SPB

Part #	Datum Length (in.)	Part #	Datum Length (in.)	Part #	Datum Length (in.)
XPB1250	49.21	XPB2240	88.19	XPB3320	130.71
XPB1320	51.97	XPB2264	89.13	XPB3340	131.50
XPB1340	52.76	XPB2280	89.76	XPB3350	131.89
XPB1400	55.12	XPB2300	90.55	XPB3450	135.83
XPB1410	55.51	XPB2310	90.94	XPB3550	139.76
XPB1450	57.09	XPB2360	92.91	SPB3650	143.70
XPB1500	59.06	XPB2410	94.88	SPB3750	147.64
XPB1550	61.02	XPB2430	95.67	SPB3800	149.61
XPB1600	62.99	XPB2500	98.43	SPB3870	152.36
XPB1650	64.96	XPB2530	99.61	SPB4000	157.48
XPB1700	66.93	XPB2580	101.57	SPB4250	167.32
XPB1778	70.00	XPB2600	102.36	SPB4500	177.17
XPB1800	70.87	XPB2650	104.33	SPB4560	179.53
XPB1850	72.83	XPB2680	105.51	SPB4620	181.89
XPB1900	74.80	XPB2720	107.09	SPB4750	187.01
XPB1950	76.77	XPB2800	110.24	SPB4820	189.76
XPB2000	78.74	XPB2820	111.02	SPB5000	196.85
XPB2020	79.53	XPB2840	111.81	SPB5300	208.66
XPB2060	81.10	XPB2900	114.17	SPB5600	220.47
XPB2120	83.46	XPB3000	118.11	SPB6000	236.22
XPB2150	84.65	XPB3150	124.02	SPB8000	314.96
XPB2180	85.83	XPB3170	124.80	SPB9000	354.33

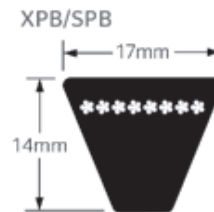

*Denotes cog construction. EPDM -40°F to 230°F (-40°C to 110°C) temperature range.

XPC*/SPC

Part #	Datum Length (in.)	Part #	Datum Length (in.)	Part #	Datum Length (in.)
XPC1047	41.22	XPC3150	124.02	SPC5000	196.85
XPC2120	83.46	XPC3350	131.89	SPC5300	208.66
XPC2240	88.19	XPC3550	139.76	SPC5600	220.47
XPC2360	92.91	SPC3750	147.64	SPC6000	236.22
XPC2500	98.43	SPC4000	157.48	SPC6700	263.78
XPC2650	104.33	SPC4250	167.32	SPC7100	279.53
XPC2800	110.24	SPC4500	177.17	SPC7500	295.28
XPC3000	118.11	SPC4750	187.01	SPC8000	314.96

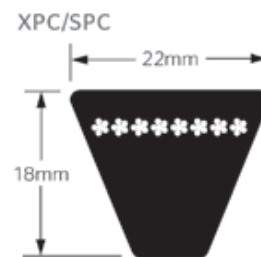

*Denotes cog construction. EPDM -40°F to 230°F (-40°C to 110°C) temperature range.

Hex Belts

Dependable power from both sides

Hex belts, also known as double V-belts, are designed for use on drives with one or more reverse bends. They usually transmit power from both sides of the belt.

To meet the multiple-bend and dual-power requirements, we build Hex belts with rugged Vytacord® tension members. They deliver maximum strength with minimum elongation. They also work with all the other quality materials that are a part of our Hex belts to deliver maximum performance over a long, trouble-free life.

Hex belts are available in AA, BB and CC cross sections. A special Dry Can Hex construction is available with a special deep CC cross section designated CCP.



Part Number: BB75

BB	B section double Classical profile 0.66 in. center width
75	Approximate 75 in. inside length

Applications

Used on drives having one or more reverse bends and usually where power must be transmitted to or from the belt in both the usual and reverse positions.

- › Lawn and garden equipment
- › Agitators
- › Conveyors
- › Mixers
- › Mule drives
- › Crushers

Key features & benefits

- › Dual-sided Classical profile.
- › High-strength Vytacord® tensile members.
- › Engineered rubber compound-impregnated envelope.
- › Engineered rubber cushion and insulation.
- › Oil, heat, ozone and abrasion resistant.
- › Static conductive.*

To learn more, visit www.contitech.us.

*Drive conditions and service variables in combination with time in operation can result in a loss of static conductivity. It is recommended that a conductivity check be added to drive preventive maintenance programs where belt static conductivity is a requirement.

Hex Belts

Cross Sections and Lengths Available

AA

Part #	Approx. Outside Length (in.)	Part #	Approx. Outside Length (in.)	Part #	Approx. Outside Length (in.)
AA51	54.4	AA70	73.4	AA96	99.4
AA55	58.4	AA75	78.4	AA105	108.4
AA60	63.4	AA80	83.4	AA112	115.4
AA64	67.4	AA85	88.4	AA120	123.4
AA66	69.4	AA90	93.4	AA128	131.4
AA68	71.4	AA92	95.4		

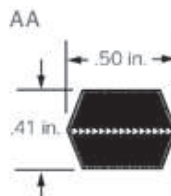

BB

Part #	Approx. Outside Length (in.)	Part #	Approx. Outside Length (in.)	Part #	Approx. Outside Length (in.)
BB35	39.6	BB96	100.6	BB162	166.6
BB38	42.6	BB97	101.6	BB168	172.6
BB42	46.6	BB103	107.6	BB169	173.6
BB43	47.6	BB105	109.6	BB173	177.6
BB45	49.6	BB107	111.6	BB180	184.6
BB46	50.6	BB108	112.6	BB182	186.6
BB53	57.6	BB111	115.6	BB190	194.6
BB55	59.6	BB112	116.6	BB195	199.6
BB60	64.6	BB116	120.6	BB210	214.6
BB64	68.6	BB117	121.6	BB225	228.1
BB68	72.6	BB118	122.6	BB226	229.1
BB71	75.6	BB120	124.6	BB228	231.1
BB72	76.6	BB122	126.6	BB230	233.1
BB73	77.6	BB123	127.6	BB240	243.1
BB74	78.6	BB124	128.6	BB255	258.1
BB75	79.6	BB128	132.6	BB267	270.1
BB81	85.6	BB129	133.6	BB270	273.1
BB83	87.6	BB130	134.6	BB273	276.1
BB85	89.6	BB136	140.6	BB277	280.1
BB90	94.6	BB140	144.6	BB278	281.1
BB92	96.6	BB144	148.6	BB285	288.1
BB93	97.6	BB155	159.6	BB300	308.1
BB94	98.6	BB158	162.6		

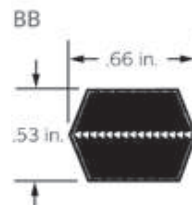

CC

Part #	Approx. Outside Length (in.)	Part #	Approx. Outside Length (in.)	Part #	Approx. Outside Length (in.)
CC75	81.4	CC136	142.4	CC225	229.4
CC81	87.4	CC144	150.4	CC240	244.4
CC85	91.4	CC148	154.4	CC255	259.4
CC90	96.4	CC158	164.4	CC270	274.4
CC96	102.4	CC162	168.4	CC300	304.4
CC105	111.4	CC173	179.4	CC330	334.4
CC112	118.4	CC180	186.4	CC360	364.4
CC120	126.4	CC195	201.4	CC390	394.4
CC128	134.4	CC210	216.4	CC420	424.4

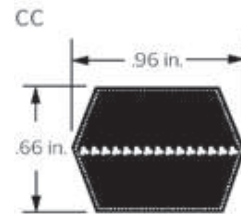

CCP

Part #	Approx. Outside Length (in.)	Part #	Approx. Outside Length (in.)	Part #	Approx. Outside Length (in.)
CCP240	244.9	CCP450	454.9	CCP670	674.9
CCP255	259.9	CCP470	474.9	CCP680	684.9
CCP270	274.9	CCP480	484.9	CCP700	704.9
CCP300	304.9	CCP540	544.9	CCP720	724.9
CCP330	334.9	CCP550	554.9	CCP750	754.9
CCP360	364.9	CCP578	582.9	CCP780	784.9
CCP390	394.9	CCP600	604.9	CCP800	804.9
CCP408	412.9	CCP640	644.9	CCP840	844.9
CCP420	424.9	CCP660	664.9	CCP900	904.9

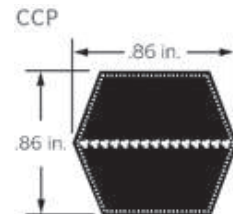

Insta-Power® (Aramid Classical) Belts

Built for strength and endurance

Every element of the Insta-Power® belt is designed to deliver premium, long-life performance in demanding outdoor power equipment service. Insta-Power® belts are engineered to take the abuse of repeated sudden shock loads, tolerate high ambient temperatures and resist the damaging effects of oil and dust.



Part Number: 84310

84	Top width designation: 84 denotes 4/8 in. top width
31	Length in in.
0	Tenths of an in. A29F - equivalent Classical size

The fabric cover on Insta-Power® belts is impregnated with our exclusive engineered rubber compound for high-wear, abrasion and oil resistance. It also resists drying and cracking, even at high temperatures. The compression section is specially compounded to provide the excellent flexibility required for a wide variety of high-stress drives. The load carrying tensile members are high-strength aramid cable cord with proven reliability in lawn and garden applications.

Applications

Delivers high performance consistently in lawn and garden drives up to 20 horsepower. Also ideal for other power equipment where reverse bend idlers, misalignment and quarter-turn drives cause ordinary belts to fail.

Key features & benefits

- › Aramid Classical profile construction.
- › High-strength aramid tensile members.
- › Engineered rubber cushion compound.
- › Premium envelope construction.
- › Triple part number branding (Insta-Power®, Classical and Fraction horsepower).
- › Oil, heat, ozone and abrasion resistant.
- › Static conductive.*

Cross Sections and Lengths Available

For sizes not listed, contact Continental ContiTech customer service for construction.

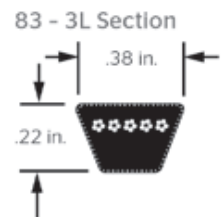

83 (3/8 in.) - 3L Section

Insta-Power® Part

83170*	83255*	83350	83450
83180*	83260	83360	83460*
83190	83270	83370**	83470*
83200	83280	83375*	83480*
83210	83290**	83380	83490*
83220**	83295*	83390	83500
83225**	83300	83400	83510*
83230**	83310	83410	83560*
83235**	83315	83415*	83570
83240	83320	83420	83610*
83245**	83330	83430	
83250	83340	83440	

*Minimum mandrels apply.

**Cut-edge construction.

*Drive conditions and service variables in combination with time in operation can result in a loss of static conductivity. It is recommended that a conductivity check be added to drive preventive maintenance programs where belt static conductivity is a requirement.

Cross Sections and Lengths Available

For sizes not listed, contact Continental ContiTech customer service for construction.

84 (4/8 in.) - A Section or 4L Section

Insta-Power® Part #	Aramid Classical	Insta-Power® Part #	Aramid Classical	Insta-Power® Part #	Aramid Classical
84170*	A15F	84385		84670	A65F
84180*	A16F	84390	A37F	84680	A66F
84190	A17F	84400	A38F	84690	A67F
84200	A18F	84405*		84700	A68F
84210	A19F	84410	A39F	84710	A69F
84220	A20F	84415*		84720	A70F
84230	A21F	84420	A40F	84730	A71F
84240	A22F	84425		84740	A72F
84250	A23F	84430	A41F	84750	A73F
84255		84440	A42F	84760	A74F
84260*	A24F	84450	A43F	84770	A75F
84270	A25F	84460	A44F	84780	A76F
84275		84470	A45F	84790	A77F
84280	A26F	84475		84800	A78F
84285*		84480	A46F	84810	A79F
84290	A27F	84485*		84820	A80F
84295		84490	A47F	84830	A81F
84300	A28F	84500	A48F	84840	A82F
84305		84510	A49F	84850	A83F
84310	A29F	84520	A50F	84860	A84F
84315		84530	A51F	84870	A85F
84320	A30F	84540	A52F	84880	A86F
84325		84550	A53F	84890	A87F
84330	A31F	84560	A54F	84900	A88F
84335		84570	A55F	84910	A89F
84340	A32F	84580	A56F	84920	A90F
84345		84590	A57F	84930	A91F
84350	A33F	84600	A58F	84940	A92F
84355		84610	A59F	84950	A93F
84360	A34F	84620	A60F	84960	A94F
84365		84630	A61F	84970	A95F
84370	A35F	84640	A62F	84980	A96F
84375		84650	A63F	84990	A97F
84380	A36F	84660	A64F	84999	A98F

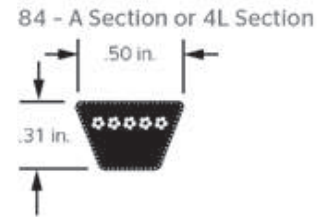

*Minimum mandrels apply.

Insta-Power® (Aramid Classical) Belts

Cross Sections and Lengths Available

For sizes not listed, contact Continental ContiTech customer service for construction.

85 - (5/8 in.)- B Section or 5L Section

Insta-Power® Part #	Aramid Classical	Insta-Power® Part #	Aramid Classical	Insta-Power® Part #	Aramid Classical
85240	B21F	85490	B46F	85750	B72F
85250	B22F	85500	B47F	85760	B73F
85260	B23F	85510	B48F	85770	B74F
85270	B24F	85520	B49F	85780	B75F
85280	B25F	85530	B50F	85790	B76F
85290	B26F	85540	B51F	85800	B77F
85300	B27F	85550	B52F	85810	B78F
85310	B28F	85560	B53F	85820	B79F
85320	B29F	85570	B54F	85830	B80F
85330	B30F	85580	B55F	85540	B81F
85335		85590	B56F	85850	B82F
85340	B31F	85600	B57F	85860	B83F
85350	B32F	85610	B58F	85870	B84F
85360	B33F	85620	B59F	85880	B85F
85370	B34F	85630	B60F	85890	B86F
85380	B35F	85640	B61F	85900	B87F
85390	B36F	85650	B62F	85910	B88F
85400	B37F	85660	B63F	85920	B89F
85410	B38F	85670	B64F	85930	B90F
85420	B39F	85680	B65F	85940	B91F
85430	B40F	85690	B66F	85950	B92F
85440	B41F	85700	B67F	85960	B93F
85450	B42F	85710	B68F	85970	B94F
85460	B43F	85720	B69F	85980*	B95F
85470	B44F	85730	B70F	85990	B96F
85480	B45F	85740	B71F	85999	B97F

85 - B Section or 5L Section

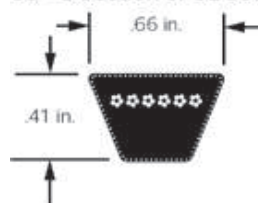

*Minimum mandrels apply.

87 (7/8 in.) - C Section

Insta-Power® Part #	Aramid Classical	Insta-Power® Part #	Aramid Classical	Insta-Power® Part #	Aramid Classical
87720	C68F	87940	C90F	871160	C112F
87790	C75F	871000	C96F	871240	C120F
87850	C81F	871040	C100F	871320	C128F
87890	C85F	871090	C105F		

87 - C Section

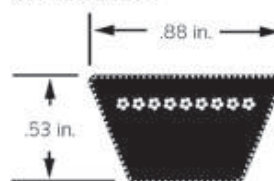

*Minimum mandrels apply.

FHP V-Belts

Quiet, smooth-running, exceptionally energy efficient

Our FHP V-belts run smoother and quieter, last longer and substantially improve energy efficiency compared to noncogged belts.

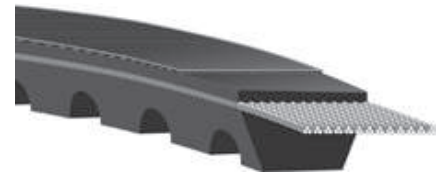

Part Number: 4L560

4L	0.50 in. top width
560	56 in. nominal outside length
	Cut-edge, molded cog construction shown

You no longer have to accept the lower energy efficiency associated with envelope belts on fractional horsepower light-duty drives. Advanced V-belt technology has resulted in the development of a cut-edge, molded cog construction which exceeds conventional envelope belts in every performance category except oil resistance confirmed in extensive testing.

In addition, the efficiency of our FHP V-belts offers you the opportunity to achieve full operating power requirements with a lower horsepower drive, reduced energy requirements or both. These considerations can provide highly desirable economic advantages whether you are a drive manufacturer or a drive user.

Cogged for cooler running

The cogged design of our FHP V-belts (standard on 4L and 5L sizes) provides a greater surface area for heat dissipation and allows increased air flow around the belt during operation. These factors help to reduce internal belt temperatures and greatly improve belt life. Of course, the cogged design also improves flexibility, an especially important consideration where minimum or substandard sheave diameters are involved.

Applications

For light-duty fractional horsepower motors. Molded cogs allow for use in applications where the belt is expected to perform around smaller sheave diameters.

- › Shop equipment
- › Light-duty machinery
- › Home appliances
- › Blowers

Low vibration for low noise

Low cross section vibration in rubber-edged, cogged belts reduces noise generation. This allows you to take advantage of the longer life and high efficiency of FHP V-belts in noise-sensitive equipment. But even in typical factory settings, our FHP V-belts contribute to a quieter operating environment.

Key features & benefits

- › Universal Classical profile.
- › Engineered rubber cushion and insulation.
- › Cut-edge, molded cogged construction.
- › Heat, ozone and abrasion resistant.

Superior efficiency for improved performance

The historic inefficiency of FHP drives can be traced directly to the inability of a relatively large envelope belt to transmit a low-power force efficiently. Transmission loss is especially significant in factories using large numbers of drives and where small diameter sheaves are involved. The aggregate loss can be significant enough to have an adverse effect on equipment performance.

Cogged vs. Noncogged FHP V-Belts (4L Section) Efficiency

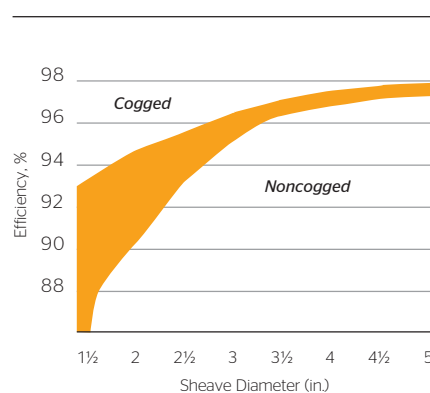

Figure 1

■ FHP V-Belts (4L Section) Efficiency

The FHP V-belt's efficiency begins at 93% when used with smaller sheaves and increases dramatically as the sheave diameter increases (Figure 1). Since more of the rated power of the drive is delivered, actual performance nearly matches design performance.

FHP V-Belts

Cross Sections and Lengths Available

2L

Part #	Approx. Outside Length (in.)	Part #	Approx. Outside Length (in.)	Part #	Approx. Outside Length (in.)
2L120	12	2L190	19	2L300	30
2L140	14	2L200	20	2L310	31
2L150	15	2L220	22	2L320	32
2L160	16	2L240	24		
2L180	18	2L260	26		

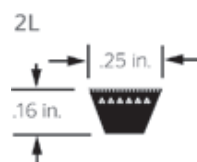

3L

Part #	Approx. Outside Length (in.)	Part #	Approx. Outside Length (in.)	Part #	Approx. Outside Length (in.)
3L120	12	3L320	32	3L530	53
3L130	13	3L330	33	3L540	54
3L140	14	3L340	34	3L550	55
3L150	15	3L350	35	3L560	56
3L160	16	3L360	36	3L570	57
3L170	17	3L370	37	3L580	58
3L180	18	3L380	38	3L590	59
3L190	19	3L390	39	3L600	60
3L200	20	3L400	40	3L610	61
3L210	21	3L420	42	3L620	62
3L220	22	3L430	43	3L630	63
3L230	23	3L440	44	3L640	64
3L240	24	3L450	45	3L650	65
3L250	25	3L460	46	3L660	66
3L260	26	3L470	47	3L670	67
3L270	27	3L480	48	3L690	69
3L280	28	3L490	49	3L730	73
3L290	29	3L500	50	3L740	74
3L300	30	3L510	51	3L760	76
3L310	31	3L520	52		

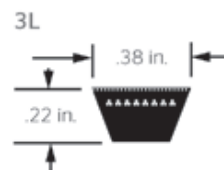

4L

Part #	Approx. Outside Length (in.)	Part #	Approx. Outside Length (in.)	Part #	Approx. Outside Length (in.)
4L150	15	4L300	30	4L460	46
4L160	16	4L320	32	4L470	47
4L170	17	4L330	33	4L480	48
4L180	18	4L340	34	4L490	49
4L190	19	4L350	35	4L500	50
4L200	20	4L360	36	4L510	51
4L210	21	4L370	37	4L520	52
4L220	22	4L380	38	4L530	53
4L230	23	4L390	39	4L540	54
4L240	24	4L400	40	4L550	55
4L250	25	4L410	41	4L560	56
4L260	26	4L420	42	4L570	57
4L270	27	4L430	43	4L580	58
4L280	28	4L440	44	4L590	59
4L290	29	4L450	45	4L600	60

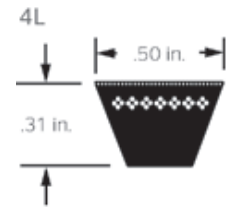

5L

Part #	Approx. Outside Length (in.)	Part #	Approx. Outside Length (in.)	Part #	Approx. Outside Length (in.)
5L230	23	5L360	36	5L490	49
5L240	24	5L370	37	5L500	50
5L250	25	5L380	38	5L510	51
5L260	26	5L390	39	5L520	52
5L270	27	5L400	40	5L530	53
5L280	28	5L410	41	5L540	54
5L290	29	5L420	42	5L550	55
5L300	30	5L430	43	5L560	56
5L310	31	5L440	44	5L570	57
5L320	32	5L450	45	5L580	58
5L330	33	5L460	46	5L590	59
5L340	34	5L470	47	5L600	60
5L350	35	5L480	48		

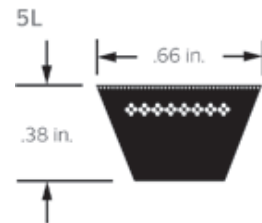

Open End V-Belting

The ideal solution for problem applications and emergency replacements



Part Number: B-Open End

B 0.66 in. top width - Classical profile
Available roll lengths (see chart below)

Continental ContiTech Open End V-belting is the perfect answer for applications where endless V-belts are difficult or impossible to install. It also serves as an ideal emergency replacement when the exact length of endless belt is not readily available

Open End V-belting will operate in any drive as long as ARPM standard sheave dimensions are observed and the recommended maximum speed of 3,500 feet per minute is not exceeded. It is not recommended as a permanent substitute for endless V-belts except on drives where standard belts cannot be installed.

Horsepower ratings

The horsepower ratings for fastened Open End V-belts are approximately 30% of published horsepower ratings for Continental ContiTech standard multiple V-belts.

Note: Because of differences in the elongation characteristics and variations in cross section dimensions, Open End V-belts and Endless V-belts should not be used together on multiple drives.

Applications

Ideal solution for temporary replacement in emergency situations or for long center drives. They can be used on all types of industrial applications.

Key features & benefits

- › Universal Classical profile.
- › Multiple-ply, square-woven fabric tension members.
- › Oil, heat, ozone and abrasion resistant.
- › Easy installation with spliced ends.
- › Static conductive.*

Regular Construction

A Section

B Section

C Section

D Section

Roll Lot: Either 250 ft. (maximum 2 pieces) or 500 ft. (maximum 3 pieces) approximate rolls. *D* section available only in 250 ft. (maximum 2 pieces) approximate rolls.

To learn more, visit www.contitech.us.

*Drive conditions and service variables in combination with time in operation can result in a loss of static conductivity. It is recommended that a conductivity check be added to drive preventive maintenance programs where belt static conductivity is a requirement.

Metal Sheaves and Pulleys

Available Parts



Part Number: 3V3.0-2-JA

- 3V** Cross section
- 3.0** 3 in. pulley diameter
- 2** 2 grooves per teeth
- JA** Bushing

3V Narrow (Ultra-V) Sheaves

Part #	SAP #	Weight*	Part #	SAP #	Weight*	Part #	SAP #	Weight*
3V2.2-1-JA	20180540	0.6	3V4.5-4-SDS	20180591	3.5	3V6.0-6-SK	20180630	9.2
3V2.2-2-JA	20180541	0.7	3V4.75-1-SH	20180593	2.6	3V6.0-8-SK	20180631	10.8
3V2.35-1-JA	20180542	0.8	3V4.75-2-SH	20180594	3.2	3V6.0-10-SK	20180624	12.4
3V2.35-2-JA	20180543	1.0	3V4.75-3-SDS	20180595	3.6	3V6.5-1-SH	20180633	4.0
3V2.5-1-JA	20180544	0.9	3V4.75-4-SDS	20180596	4.1	3V6.5-2-SDS	20180634	4.8
3V2.5-2-JA	20180545	1.1	3V4.75-5-SDS	20180597	4.7	3V6.5-3-SDS	20180635	5.8
3V2.5-3-JA	20180546	1.4	3V4.75-6-SK	20180598	5.2	3V6.5-4-SK	20180636	9.3
3V2.65-1-JA	20180547	0.6	3V4.75-8-SK	20180599	6.4	3V6.5-5-SK	20180637	10.1
3V2.65-2-JA	20180548	0.8	3V4.75-10-SK	20180592	7.6	3V6.5-6-SK	20180638	10.9
3V2.65-3-JA	20180549	1.1	3V5.0-1-SH	20180601	2.9	3V6.5-8-SK	20180639	12.6
3V2.65-4-JA	20180550	1.4	3V5.0-2-SH	20180602	3.6	3V6.5-10-SK	20180632	14.2
3V2.8-1-JA	20180551	0.7	3V5.0-3-SDS	20180603	4.1	3V6.9-1-SH	20180641	3.3
3V2.8-2-JA	20180552	1.0	3V5.0-4-SDS	20180604	4.6	3V6.9-2-SDS	20180642	5.5
3V2.8-3-JA	20180553	1.3	3V5.0-5-SDS	20180605	5.2	3V6.9-3-SDS	20180643	6.4
3V2.8-4-JA	20180554	1.6	3V5.0-6-SK	20180606	6.0	3V6.9-4-SK	20180644	10.9
3V3.0-1-JA	20180562	0.8	3V5.0-8-SK	20180607	7.3	3V6.9-5-SK	20180645	11.6
3V3.0-2-JA	20180563	1.2	3V5.0-10-SK	20180600	8.5	3V6.9-6-SK	20180646	12.5
3V3.0-3-SH	20180564	1.6	3V5.3-1-SH	20180609	3.1	3V6.9-8-SK	20180647	14.3
3V3.0-4-SH	20180565	1.9	3V5.3-2-SH	20180610	4.1	3V6.9-10-SK	20180640	16.1
3V3.15-1-JA	20180566	0.9	3V5.3-3-SDS	20180611	4.6	3V8.0-1-SDS	20180649	4.4
3V3.15-2-JA	20180567	1.4	3V5.3-4-SDS	20180612	5.1	3V8.0-2-SDS	20180650	5.4
3V3.15-3-SH	20180568	2.0	3V5.3-5-SK	20180613	6.2	3V8.0-3-SK	20180651	8.6
3V3.15-4-SH	20180569	2.3	3V5.3-6-SK	20180614	6.9	3V8.0-4-SK	20180652	10.1
3V3.35-1-JA	20180570	1.1	3V5.3-8-SK	20180615	8.3	3V8.0-5-SK	20180653	11.6
3V3.35-2-SH	20180571	1.3	3V5.3-10-SK	20180608	9.6	3V8.0-6-SK	20180655	12.7
3V3.35-3-SH	20180572	1.7	3V5.6-1-SH	20180617	3.5	3V8.0-8-SF	20180656	19.0
3V3.35-4-SH	20180573	2.2	3V5.6-2-SH	20180618	4.6	3V8.0-10-SF	20180648	21.2
3V3.65-1-SH	20180574	1.4	3V5.6-3-SDS	20180619	5.2	3V10.6-1-SDS	20180517	7.1
3V3.65-2-SH	20180575	1.7	3V5.6-4-SDS	20180620	5.7	3V10.6-2-SK	20180518	11.1
3V3.65-3-SH	20180576	2.3	3V5.6-5-SK	20180621	7.1	3V10.6-3-SK	20180519	12.7
3V3.65-4-SH	20180577	2.9	3V5.6-6-SK	20180622	7.8	3V10.6-4-SK	20180520	15.3
3V4.12-1-SH	20180584	1.9	3V5.6-8-SK	20180623	9.3	3V10.6-5-SK	20180521	16.9
3V4.12-2-SH	20180585	2.2	3V5.6-10-SK	20180616	10.7	3V10.6-6-SF	20180522	19.1
3V4.12-3-SH	20180586	2.7	3V6.0-1-SH	20180625	3.5	3V10.6-8-SF	20180523	22.2
3V4.12-4-SH	20180587	3.2	3V6.0-2-SH	20180626	4.5	3V10.6-10-E	20180516	33.2
3V4.5-1-SH	20180588	2.3	3V6.0-3-SDS	20180627	6.1	3V14.0-1-SK	20180525	12.4
3V4.5-2-SH	20180589	2.8	3V6.0-4-SK	20180628	7.8	3V14.0-2-SK	20180526	15.4
3V4.5-3-SDS	20180590	3.1	3V6.0-5-SK	20180629	8.5			

*Weight does not include bushing and is approximate.

continued on page 107

Metal Sheaves and Pulleys

Available Parts

3V Narrow (Ultra-V) Sheaves (continued)

Part #	SAP #	Weight*	Part #	SAP #	Weight*	Part #	SAP #	Weight*
3V14.0-3-SK	20180527	19.1	3V19.0-4-SF	20180536	36.3	3V25.0-6-E	20180560	77.7
3V14.0-4-SK	20180528	22.1	3V19.0-5-SF	20180537	43.1	3V25.0-8-E	20180561	92.5
3V14.0-5-SF	20180529	26.7	3V19.0-6-E	20180538	49.6	3V25.0-10-F	20180555	115.8
3V14.0-6-SF	20180530	28.9	3V19.0-8-E	20180539	61.6	3V33.5-3-SF	20180579	70.8
3V14.0-8-E	20180531	43.4	3V19.0-10-E	20180532	70.7	3V33.5-4-E	20180580	99.4
3V14.0-10-E	20180524	47.8	3V25.0-2-SF	20180556	37.7	3V33.5-5-E	20180581	105.8
3V19.0-1-SK	20180533	18.6	3V25.0-3-SF	20180557	42.0	3V33.5-6-E	20180582	122.0
3V19.0-2-SK	20180534	22.2	3V25.0-4-SF	20180558	55.3	3V33.5-8-F	20180583	144.4
3V19.0-3-SF	20180535	33.3	3V25.0-5-E	20180559	66.1	3V33.5-10-F	20180578	178.1

*Weight does not include bushing and is approximate.

5V Narrow (Ultra-V) Sheaves

Part #	SAP #	Weight*	Part #	SAP #	Weight*	Part #	SAP #	Weight*
5V4.4-2-SH	20180815	3.3	5V6.3-6-SK	20180858	13.8	5V8.5-7-E	20180893	28.8
5V4.4-3-SDS	20180816	4.2	5V6.7-2-SK	20180859	9.0	5V8.5-8-E	20180894	31.2
5V4.4-4-SD	20180817	5.2	5V6.7-3-SK	20180860	10.7	5V8.5-9-E	20180895	33.7
5V4.4-5-SD	20180818	6.2	5V6.7-4-SK	20180861	12.3	5V8.5-10-E	20180887	36.1
5V4.4-6-SD	20180819	7.1	5V6.7-5-SF	20180862	13.6	5V9.0-2-SK	20180897	13.4
5V4.65-2-SDS	20180820	3.4	5V6.7-6-SF	20180863	15.2	5V9.0-3-SF	20180898	20.3
5V4.65-3-SDS	20180821	4.8	5V7.1-2-SK	20180864	10.4	5V9.0-4-E	20180899	24.6
5V4.65-4-SD	20180822	6.0	5V7.1-3-SF	20180865	11.8	5V9.0-5-E	20180900	27.2
5V4.65-5-SD	20180823	7.0	5V7.1-4-SF	20180866	13.6	5V9.0-6-E	20180901	29.8
5V4.65-6-SD	20180824	8.0	5V7.1-5-SF	20180867	15.4	5V9.0-7-E	20180902	32.4
5V4.9-2-SDS	20180825	3.8	5V7.1-6-SF	20180868	17.3	5V9.0-8-E	20180903	35.0
5V4.9-3-SDS	20180826	4.9	5V7.1-7-SF	20180869	19.1	5V9.0-9-E	20180904	37.6
5V4.9-4-SD	20180827	6.6	5V7.1-8-SF	20180870	21.0	5V9.0-10-F	20180896	44.5
5V4.9-5-SD	20180828	7.6	5V7.5-2-SK	20180871	12.0	5V9.25-2-SK	20180906	13.7
5V4.9-6-SD	20180829	8.6	5V7.5-3-SF	20180872	13.6	5V9.25-3-SF	20180907	17.4
5V5.2-2-SDS	20180830	4.4	5V7.5-4-SF	20180873	15.7	5V9.25-4-E	20180908	25.9
5V5.2-3-SDS	20180831	5.6	5V7.5-5-SF	20180874	17.8	5V9.25-5-E	20180909	28.5
5V5.2-4-SD	20180832	7.6	5V7.5-6-SF	20180875	19.9	5V9.25-6-E	20180910	31.0
5V5.2-5-SD	20180833	8.8	5V7.5-7-SF	20180876	22.0	5V9.25-7-E	20180911	33.5
5V5.2-6-SD	20180834	9.9	5V7.5-8-SF	20180877	24.1	5V9.25-8-F	20180912	41.3
5V5.5-2-SDS	20180835	5.1	5V8.0-2-SK	20180879	13.9	5V9.25-9-F	20180913	43.8
5V5.5-3-SDS	20180836	6.4	5V8.0-3-SF	20180880	15.7	5V9.25-10-F	20180905	46.4
5V5.5-4-SD	20180837	8.7	5V8.0-4-E	20180881	18.6	5V9.75-2-SK	20180915	12.6
5V5.5-5-SD	20180838	10.0	5V8.0-5-E	20180882	20.9	5V9.75-3-SF	20180916	19.7
5V5.5-6-SD	20180839	11.3	5V8.0-6-E	20180883	23.1	5V9.75-4-E	20180917	29.2
5V5.9-2-SDS	20180840	5.8	5V8.0-7-E	20180884	25.4	5V9.75-5-E	20180918	31.9
5V5.9-3-SDS	20180841	7.3	5V8.0-8-E	20180885	27.7	5V9.75-6-E	20180919	34.6
5V5.9-4-SD	20180842	10.0	5V8.0-9-E	20180886	30.0	5V9.75-7-E	20180920	37.2
5V5.9-5-SK	20180843	10.6	5V8.0-10-E	20180878	32.2	5V9.75-8-F	20180921	46.6
5V5.9-6-SK	20180844	12.0	5V8.5-2-SK	20180888	12.2	5V9.75-9-F	20180922	49.3
5V6.3-2-SK	20180854	7.6	5V8.5-3-SF	20180889	17.9	5V9.75-10-F	20180914	52.0
5V6.3-3-SK	20180855	9.2	5V8.5-4-E	20180890	21.5	5V10.3-2-SK	20180658	13.7
5V6.3-4-SK	20180856	10.7	5V8.5-5-E	20180891	23.9	5V10.3-3-SF	20180659	20.7
5V6.3-5-SK	20180857	12.3	5V8.5-6-E	20180892	26.4	5V10.3-4-E	20180660	27.1

*Weight does not include bushing and is approximate.

continued on page 108

5V Narrow (Ultra-V) Sheaves (continued)

Part #	SAP #	Weight*	Part #	SAP #	Weight*	Part #	SAP #	Weight*
5V10.3-5-E	20180661	30.4	5V13.2-6-F	20180717	59.2	5V21.2-7-J	20180773	115.3
5V10.3-6-E	20180662	33.7	5V13.2-7-F	20180719	63.5	5V21.2-8-J	20180774	122.9
5V10.3-7-F	20180664	50.1	5V13.2-8-F	20180720	67.5	5V21.2-9-J	20180775	130.0
5V10.3-8-F	20180665	53.0	5V13.2-9-F	20180722	73.6	5V21.2-10-J	20180766	143.5
5V10.3-9-F	20180666	55.9	5V13.2-10-J	20180711	83.0	5V23.6-2-E	20180778	54.8
5V10.3-10-F	20180657	58.9	5V14.0-2-SF	20180724	22.9	5V23.6-3-E	20180779	69.1
5V10.9-2-SK	20180668	14.5	5V14.0-3-E	20180725	31.6	5V23.6-4-F	20180780	87.9
5V10.9-3-SF	20180669	19.4	5V14.0-4-E	20180726	37.9	5V23.6-5-F	20180781	101.6
5V10.9-4-E	20180670	29.1	5V14.0-5-E	20180727	42.3	5V23.6-6-J	20180782	117.5
5V10.9-5-E	20180671	32.7	5V14.0-6-F	20180728	64.2	5V23.6-7-J	20180784	125.8
5V10.9-6-E	20180672	36.2	5V14.0-7-F	20180730	68.7	5V23.6-8-J	20180785	138.7
5V10.9-7-F	20180674	56.7	5V14.0-8-F	20180731	72.9	5V23.6-9-J	20180786	149.2
5V10.9-8-F	20180675	59.8	5V14.0-9-F	20180732	79.8	5V23.6-10-M	20180776	211.1
5V10.9-9-F	20180676	62.9	5V14.0-10-J	20180723	89.4	5V28.0-2-E	20180788	71.1
5V10.9-10-F	20180667	65.9	5V15.0-2-SF	20180735	24.8	5V28.0-3-E	20180789	94.4
5V11.3-2-SK	20180679	16.3	5V15.0-3-E	20180736	35.7	5V28.0-4-F	20180790	115.2
5V11.3-3-SF	20180680	21.2	5V15.0-4-E	20180737	40.8	5V28.0-5-F	20180791	132.7
5V11.3-4-E	20180681	33.1	5V15.0-5-E	20180738	47.0	5V28.0-6-J	20180792	153.1
5V11.3-5-E	20180682	36.7	5V15.0-6-F	20180739	61.7	5V28.0-7-J	20180794	165.1
5V11.3-6-E	20180683	40.9	5V15.0-7-F	20180741	66.6	5V28.0-8-J	20180795	175.1
5V11.3-7-F	20180685	62.9	5V15.0-8-F	20180742	71.1	5V28.0-9-M	20180796	239.1
5V11.3-8-F	20180686	66.5	5V15.0-9-J	20180744	93.6	5V28.0-10-M	20180787	249.3
5V11.3-9-F	20180687	70.1	5V15.0-10-J	20180733	93.2	5V31.5-3-F	20180798	118.1
5V11.3-10-F	20180677	73.6	5V16.0-2-SF	20180747	27.1	5V31.5-4-F	20180799	131.3
5V11.8-2-SK	20180690	17.1	5V16.0-3-E	20180748	38.2	5V31.5-5-J	20180800	158.7
5V11.8-3-SF	20180691	23.7	5V16.0-4-E	20180749	44.1	5V31.5-6-J	20180801	182.1
5V11.8-4-E	20180692	34.9	5V16.0-5-E	20180750	50.5	5V31.5-7-J	20180803	196.2
5V11.8-5-E	20180693	38.5	5V16.0-6-F	20180751	66.0	5V31.5-8-M	20180804	261.1
5V11.8-6-E	20180694	43.5	5V16.0-7-F	20180753	72.2	5V31.5-9-M	20180805	277.1
5V11.8-7-F	20180696	53.9	5V16.0-8-F	20180754	77.0	5V31.5-10-M	20180797	294.5
5V11.8-8-F	20180697	57.5	5V16.0-9-J	20180755	93.1	5V37.5-3-F	20180807	151.5
5V11.8-9-F	20180699	61.1	5V16.0-10-J	20180745	98.1	5V37.5-4-F	20180808	181.9
5V11.8-10-F	20180688	64.6	5V18.7-2-SF	20180757	36.3	5V37.5-5-J	20180809	221.6
5V12.5-2-SF	20180702	18.9	5V18.7-3-E	20180758	47.5	5V37.5-6-J	20180810	237.8
5V12.5-3-E	20180703	28.3	5V18.7-4-E	20180759	57.3	5V37.5-7-M	20180812	315.0
5V12.5-4-E	20180704	33.7	5V18.7-5-F	20180760	76.5	5V37.5-8-M	20180813	331.6
5V12.5-5-E	20180705	37.5	5V18.7-6-F	20180761	83.0	5V37.5-9-M	20180814	363.9
5V12.5-6-F	20180706	54.7	5V18.7-7-F	20180763	89.3	5V37.5-10-M	20180806	386.4
5V12.5-7-F	20180708	58.7	5V18.7-8-J	20180764	106.3	5V50.0-3-F	20180846	222.5
5V12.5-8-F	20180709	62.4	5V18.7-9-J	20180765	112.7	5V50.0-4-J	20180847	240.8
5V12.5-9-F	20180710	66.4	5V18.7-10-J	20180756	120.4	5V50.0-5-J	20180848	296.8
5V12.5-10-J	20180700	77.0	5V21.2-2-SF	20180767	42.1	5V50.0-6-M	20180849	367.5
5V13.2-2-SF	20180713	20.1	5V21.2-3-E	20180768	54.2	5V50.0-7-M	20180851	422.1
5V13.2-3-E	20180714	30.2	5V21.2-4-E	20180769	66.5	5V50.0-8-M	20180852	472.7
5V13.2-4-E	20180715	35.8	5V21.2-5-F	20180770	87.0	5V50.0-9-M	20180853	494.6
5V13.2-5-E	20180716	39.9	5V21.2-6-F	20180771	96.2	5V50.0-10-M	20180845	548.3

*Weight does not include bushing and is approximate.

Metal Sheaves and Pulleys

Available Parts

8V Narrow (Ultra-V) Sheaves

Part #	SAP #	Weight*	Part #	SAP #	Weight*	Part #	SAP #	Weight*
8V12.5-4-F	20180925	75.0	8V18.0-5-J	20180962	131.5	8V30.0-6-M	20180999	319.8
8V12.5-5-F	20180926	82.8	8V18.0-6-J	20180963	143.6	8V30.0-8-N	20181000	410.9
8V12.5-6-F	20180927	90.6	8V18.0-8-M	20180964	213.4	8V30.0-10-N	20180995	505.8
8V12.5-8-J	20180928	113.0	8V18.0-10-M	20180959	248.1	8V30.0-12-P	20180996	584.5
8V12.5-10-J	20180923	132.8	8V18.0-12-M	20180960	303.2	8V35.5-4-M	20181003	294.6
8V12.5-12-M	20180924	163.1	8V19.0-4-F	20180967	116.7	8V35.5-5-M	20181004	356.9
8V13.2-4-F	20180931	68.0	8V19.0-5-J	20180968	142.2	8V35.5-6-N	20181005	415.8
8V13.2-5-F	20180932	77.7	8V19.0-6-J	20180969	155.1	8V35.5-8-N	20181006	523.9
8V13.2-6-F	20180933	86.1	8V19.0-8-M	20180970	228.7	8V35.5-10-P	20181001	618.4
8V13.2-8-J	20180934	109.1	8V19.0-10-M	20180965	266.1	8V35.5-12-P	20181002	711.2
8V13.2-10-J	20180929	132.5	8V19.0-12-N	20180966	329.2	8V40.0-4-M	20181009	373.0
8V13.2-12-M	20180930	185.2	8V20.0-4-J	20180973	112.3	8V40.0-5-M	20181010	406.3
8V14.0-4-F	20180937	74.0	8V20.0-5-J	20180974	151.5	8V40.0-6-N	20181011	498.1
8V14.0-5-F	20180938	84.7	8V20.0-6-M	20180975	208.1	8V40.0-8-N	20181012	599.7
8V14.0-6-F	20180939	93.6	8V20.0-8-M	20180976	250.6	8V40.0-10-P	20181007	730.3
8V14.0-8-J	20180940	118.1	8V20.0-10-M	20180971	283.9	8V40.0-12-P	20181008	821.9
8V14.0-10-J	20180935	144.9	8V20.0-12-N	20180972	350.4	8V44.5-4-M	20181015	400.2
8V14.0-12-M	20180936	210.9	8V21.2-4-J	20180979	126.8	8V44.5-5-N	20181016	486.2
8V15.0-4-F	20180943	82.2	8V21.2-5-J	20180980	167.8	8V44.5-6-N	20181017	521.6
8V15.0-5-F	20180944	94.3	8V21.2-6-M	20180981	228.6	8V44.5-8-P	20181018	696.2
8V15.0-6-J	20180945	111.1	8V21.2-8-M	20180982	269.8	8V44.5-10-P	20181013	766.9
8V15.0-8-J	20180946	130.4	8V21.2-10-M	20180977	306.0	8V44.5-12-P	20181014	895.4
8V15.0-10-M	20180941	224.5	8V21.2-12-N	20180978	369.3	8V53.0-4-M	20181021	509.6
8V15.0-12-M	20180942	245.5	8V22.4-4-J	20180985	138.2	8V53.0-5-N	20181022	624.8
8V16.0-4-F	20180949	88.4	8V22.4-5-M	20180986	241.6	8V53.0-6-N	20181023	705.7
8V16.0-5-F	20180950	101.7	8V22.4-6-M	20180987	246.2	8V53.0-8-P	20181024	886.0
8V16.0-6-J	20180951	121.5	8V22.4-8-M	20180988	303.7	8V53.0-10-P	20181019	1024.0
8V16.0-8-J	20180952	142.7	8V22.4-10-N	20180983	359.3	8V53.0-12-W	20181020	1305.2
8V16.0-10-M	20180947	262.0	8V22.4-12-N	20180984	406.5	8V63.0-6-P	20181027	890.4
8V16.0-12-M	20180948	285.1	8V24.8-4-M	20180991	212.8	8V63.0-8-P	20181028	1116.9
8V17.0-4-F	20180955	99.0	8V24.8-5-M	20180992	231.9	8V63.0-10-W	20181025	1412.0
8V17.0-5-J	20180956	117.3	8V24.8-6-M	20180993	250.9	8V63.0-12-W	20181026	1540.5
8V17.0-6-J	20180957	131.8	8V24.8-8-N	20180994	365.7	8V71.0-6-P	20181031	1045.8
8V17.0-8-M	20180958	202.1	8V24.8-10-N	20180989	411.3	8V71.0-8-W	20181032	1478.6
8V17.0-10-M	20180953	234.4	8V24.8-12-N	20180990	464.8	8V71.0-10-W	20181029	1617.3
8V17.0-12-M	20180954	286.6	8V30.0-4-M	20180997	252.0	8V71.0-12-W	20181030	1757.8
8V18.0-4-F	20180961	107.7	8V30.0-5-M	20180998	293.0			

*Weight does not include bushing and is approximate.

“A” Classical (Conventional) Sheaves

Part #	SAP #	Weight*	Part #	SAP #	Weight*	Part #	SAP #	Weight*
3.4-2A-SH	20179193	1.9	4.6-2A-SDS	20179273	3.0	18.0-2A-SK	20179098	19.8

“A/B” Classical (Conventional) Sheaves

Part #	SAP #	Weight*	Part #	SAP #	Weight*	Part #	SAP #	Weight*
3.4-1B-SH	20179192	1.2	4.8-3B-SD	20179281	6.4	6.0-2B-SDS*	20179367	6.6
3.4-2B-SH	20179194	2.2	4.8-4B-SD	20179282	7.7	6.0-3B-SD*	20179368	10.1
3.4-3B-SH	20179195	3.0	4.8-5B-SD	20179283	9.0	6.0-4B-SD	20179370	11.7
3.4-4B-SD	20179196	4.0	4.8-6B-SD	20179284	9.9	6.0-5B-SK	20179372	12.5
3.4-5B-SD	20179197	4.8	5.0-1B-SDS	20179306	3.1	6.0-6B-SK	20179374	14.5
3.4-6B-SD	20179198	5.6	5.0-2B-SDS	20179307	4.6	6.0-7B-SF	20179376	15.2
3.6-1B-SH	20179199	1.4	5.0-3B-SD	20179308	7.0	6.0-8B-SF	20179377	16.7
3.6-2B-SH	20179200	2.5	5.0-4B-SD	20179310	8.0	6.0-10B-SF	20179365	19.9
3.6-3B-SH	20179201	3.4	5.0-5B-SD	20179312	9.7	6.2-1B-SDS	20179379	4.3
3.6-4B-SD	20179202	4.6	5.0-6B-SD	20179313	10.7	6.2-2B-SDS	20179380	6.9
3.6-5B-SD	20179203	5.5	5.2-1B-SDS	20179314	3.3	6.2-3B-SD	20179381	10.7
3.6-6B-SD	20179204	6.4	5.2-2B-SDS	20179316	5.2	6.2-4B-SD	20179382	11.8
3.8-1B-SH	20179205	1.6	5.2-3B-SD	20179317	7.7	6.2-5B-SK	20179383	13.7
3.8-2B-SH	20179206	2.9	5.2-4B-SD	20179318	9.1	6.2-6B-SK	20179384	15.4
3.8-3B-SH	20179207	3.8	5.2-5B-SD	20179319	10.5	6.2-7B-SF	20179385	16.7
3.8-4B-SD	20179208	5.1	5.2-6B-SD	20179320	11.9	6.2-8B-SF	20179386	18.5
3.8-5B-SD	20179209	6.1	5.4-1B-SDS	20179322	3.6	6.2-10B-SF	20179378	22.0
3.8-6B-SD	20179210	7.0	5.4-2B-SDS	20179323	5.5	6.4-1B-SDS	20179388	4.6
4.0-1B-SH	20179254	2.1	5.4-3B-SD	20179324	8.2	6.4-2B-SDS	20179389	7.1
4.0-2B-SH	20179255	3.1	5.4-4B-SD	20179325	9.4	6.4-3B-SD	20179390	9.4
4.0-3B-SH	20179256	4.1	5.4-5B-SK	20179326	10.0	6.4-4B-SD	20179391	12.3
4.0-4B-SD	20179257	5.4	5.4-6B-SK	20179327	11.3	6.4-5B-SK	20179392	14.3
4.0-5B-SD	20179258	6.4	5.4-7B-SK	20179328	12.7	6.4-6B-SK	20179393	16.0
4.0-6B-SD	20179259	7.4	5.4-8B-SK	20179329	14.0	6.4-7B-SF	20179394	17.3
4.2-1B-SH	20179260	2.3	5.4-10B-SK	20179321	16.7	6.4-8B-SF	20179395	19.0
4.2-2B-SH	20179261	3.8	5.6-1B-SDS	20179331	3.8	6.4-10B-SF	20179387	22.5
4.2-3B-SH	20179262	4.5	5.6-2B-SDS*	20179332	5.8	6.6-1B-SDS	20179397	5.4
4.2-4B-SD	20179263	5.8	5.6-3B-SD*	20179334	8.9	6.6-2B-SDS	20179398	7.2
4.2-5B-SD	20179264	6.8	5.6-4B-SD	20179336	10.2	6.6-3B-SD	20179399	9.4
4.2-6B-SD	20179265	7.9	5.6-5B-SK	20179338	10.9	6.6-4B-SD	20179400	11.0
4.4-1B-SH	20179266	2.5	5.6-6B-SK	20179339	12.6	6.6-5B-SK	20179401	15.0
4.4-2B-SH	20179267	3.8	5.6-7B-SK	20179340	14.1	6.6-6B-SK	20179402	16.7
4.4-3B-SH	20179268	4.9	5.6-8B-SK	20179341	15.6	6.6-7B-SF	20179403	18.4
4.4-4B-SD	20179269	6.3	5.6-10B-SK	20179330	18.6	6.6-8B-SF	20179404	20.2
4.4-5B-SD	20179270	7.3	5.8-1B-SDS	20179343	3.9	6.6-10B-SF	20179396	23.8
4.4-6B-SD	20179271	8.4	5.8-2B-SDS	20179344	6.4	6.8-1B-SDS	20179406	5.6
4.6-1B-SDS	20179272	2.5	5.8-3B-SD	20179345	9.6	6.8-2B-SDS*	20179407	7.7
4.6-2B-SDS	20179274	3.8	5.8-4B-SD	20179346	11.0	6.8-3B-SD*	20179408	10.4
4.6-3B-SD	20179275	5.7	5.8-5B-SK	20179347	11.7	6.8-4B-SD	20179409	12.3
4.6-4B-SD	20179276	6.9	5.8-6B-SK	20179348	13.5	6.8-5B-SK	20179410	16.2
4.6-5B-SD	20179277	8.0	5.8-7B-SK	20179349	15.1	6.8-6B-SK	20179411	18.1
4.6-6B-SD	20179278	9.1	5.8-8B-SK	20179350	16.7	6.8-7B-SF	20179412	19.5
4.8-1B-SDS	20179279	2.8	5.8-10B-SK	20179342	19.8	6.8-8B-SF	20179413	21.4
4.8-2B-SDS	20179280	4.2	6.0-1B-SDS	20179366	4.2	6.8-10B-SF	20179405	25.2

*Weight does not include bushing and is approximate.

continued on page 111

Metal Sheaves and Pulleys

Available Parts

"A/B" Classical (Conventional) Sheaves (continued)

Part #	SAP #	Weight*	Part #	SAP #	Weight*	Part #	SAP #	Weight*
7.0-1B-SDS	20179415	6.1	11.0-3B-SK*	20178938	17.6	18.4-2B-SK	20179114	27.6
7.0-2B-SK*	20179417	11.3	11.0-4B-SK	20178940	24.4	18.4-3B-SK	20179115	33.6
7.0-3B-SK*	20179419	13.2	11.0-5B-SF	20178942	25.0	18.4-4B-SF	20179116	42.0
7.0-4B-SK	20179421	15.2	11.0-6B-SF	20178944	29.7	8.4-5B-SF	20179117	51.8
7.0-5B-SF	20179423	16.7	11.0-7B-E	20178946	42.0	18.4-6B-SF	20179118	57.7
7.0-6B-SF	20179425	18.7	11.0-8B-E	20178948	45.3	18.4-7B-F	20179119	77.1
7.0-7B-SF	20179427	20.7	11.0-10B-E	20178931	51.9	18.4-8B-F	20179120	86.5
7.0-8B-SF	20179429	22.7	12.4-1B-SDS	20178970	11.2	18.4-10B-F	20179112	98.1
7.0-10B-SF	20179414	26.6	12.4-2B-SK	20178971	17.0	20.0-1B-SK	20179126	28.9
7.4-1B-SDS	20179432	6.5	12.4-3B-SK	20178972	20.5	20.0-2B-SF	20179128	33.2
7.4-2B-SK	20179433	11.7	12.4-4B-SK	20178973	25.7	20.0-3B-SF	20179130	38.6
7.4-3B-SK	20179434	14.9	12.4-5B-SF	20178974	29.5	20.0-4B-SF	20179132	49.1
7.4-4B-SK	20179435	14.2	12.4-6B-SF	20178975	34.5	20.0-5B-E	20179135	62.0
7.4-5B-SF	20179436	18.5	12.4-7B-E	20178976	49.4	20.0-6B-E	20179138	71.4
7.4-6B-SF	20179437	20.6	12.4-8B-E	20178977	52.7	20.0-7B-F	20179141	92.3
7.4-7B-SF	20179438	22.7	12.4-10B-E	20178969	59.9	20.0-8B-F	20179143	98.8
7.4-8B-SF	20179439	24.8	13.6-1B-SDS	20179004	13.0	20.0-10B-F	20179121	111.9
7.4-10B-SF	20179431	28.9	13.6-2B-SK	20179005	18.2	25.0-1B-SF	20179169	40.0
8.0-1B-SDS	20179447	7.4	13.6-3B-SK	20179006	21.4	25.0-2B-SF	20179170	50.3
8.0-2B-SK*	20179449	11.5	13.6-4B-SK	20179007	27.1	25.0-3B-SF	20179171	62.8
8.0-3B-SK*	20179451	13.8	13.6-5B-SF	20179008	32.2	25.0-4B-E	20179172	76.3
8.0-4B-SK	20179453	16.2	13.6-6B-SF	20179009	37.4	25.0-5B-E	20179173	90.3
8.0-5B-SF	20179455	19.3	13.6-7B-E	20179010	48.9	25.0-6B-E	20179174	109.9
8.0-6B-SF	20179457	24.1	13.6-8B-E	20179011	52.9	25.0-7B-F	20179175	123.2
8.6-1B-SDS	20179473	8.3	13.6-10B-F	20179003	73.2	25.0-8B-F	20179176	135.5
8.6-2B-SK*	20179474	12.5	15.4-1B-SK	20179045	16.7	25.0-10B-F	20179168	115.1
8.6-3B-SK*	20179475	14.8	15.4-2B-SK*	20179046	21.6	30.0-1B-SF	20179214	52.0
8.6-4B-SK	20179476	14.6	15.4-3B-SK*	20179047	26.3	30.0-2B-SF	20179215	71.2
8.6-5B-SF	20179477	17.8	5.4-4B-SF	20179048	33.0	30.0-3B-SF	20179217	87.4
8.6-6B-SF	20179478	27.3	5.4-5B-SF	20179049	39.3	30.0-4B-E	20179219	103.2
8.6-7B-E	20179479	31.5	15.4-6B-SF	20179050	43.1	30.0-5B-E	20179221	117.3
8.6-8B-E	20179480	34.0	15.4-7B-E	20179051	60.5	30.0-6B-E	20179223	129.8
8.6-10B-E	20179472	38.9	15.4-8B-E	20179052	63.9	30.0-7B-F	20179225	151.8
9.4-1B-SDS	20179498	7.4	15.4-10B-F	20179044	85.7	30.0-8B-F	20179227	162.3
9.4-2B-SK*	20179499	12.5	16.0-1B-SK	20179065	16.4	30.0-10B-F	20179211	193.4
9.4-3B-SK*	20179500	15.1	16.0-2B-SK	20179067	21.9	38.0-2B-SF	20179247	94.9
9.4-4B-SK	20179501	21.1	16.0-3B-SK	20179069	29.1	38.0-3B-E	20179248	136.4
9.4-5B-SF	20179502	20.6	16.0-4B-SF	20179072	35.8	38.0-4B-E	20179249	151.1
9.4-6B-SF	20179503	27.1	16.0-5B-SF	20179075	44.1	38.0-5B-E	20179250	165.8
9.4-7B-E	20179504	32.7	16.0-6B-SF	20179078	48.8	38.0-6B-E	20179251	183.0
9.4-8B-E	20179505	34.2	16.0-7B-E	20179081	63.7	38.0-7B-F	20179252	233.0
9.4-10B-E	20179497	39.9	16.0-8B-E	20179083	67.0	38.0-8B-F	20179253	236.5
11.0-1B-SDS	20178934	10.7	16.0-10B-F	20179060	89.4	38.0-10B-J	20179246	290.2
11.0-2B-SK*	20178936	14.2	18.4-1B-SK	20179113	19.4			

*Weight does not include bushing and is approximate.

“A/B” Classical (Conventional) Sheaves (Large Bore)

Part #	SAP #	Weight*	Part #	SAP #	Weight*	Part #	SAP #	Weight*
5.6-2LB-SF	20332969	6.1	7.0-2LB-SF	20333005	10.8	9.4-2LB-SF	20333011	14.7
5.6-3LB-SF	20333000	7.6	7.0-3LB-SF	20333006	12.7	9.4-3LB-SF	20333012	17.7
6.0-2LB-SF	20333001	7.3	8.0-2LB-SF	20333007	14.8	11.0-2LB-SF	20333013	16.1
6.0-3LB-SF	20333002	8.7	8.0-3LB-SF	20333008	17.1	11.0-3LB-SF	20333014	19.9
6.8-2LB-SF	20333003	10.0	8.6-2LB-SF	20333009	13.0	15.4-2LB-SF	20333015	23.4
6.8-3LB-SF	20333004	11.8	8.6-3LB-SF	20333010	15.3	15.4-3LB-SF	20333016	29.1

*Weight does not include bushing and is approximate.

“C” Classical (Conventional) Sheaves

Part #	SAP #	Weight*	Part #	SAP #	Weight*	Part #	SAP #	Weight*
5.0-3C-SD	20179309	8.6	8.5-2C-SF	20179464	16.6	10.0-4C-E	20178914	38.1
5.0-4C-SD	20179311	10.2	8.5-3C-E	20179465	23.7	10.0-5C-E	20178915	42.4
5.6-2C-SD	20179333	8.8	8.5-4C-E	20179466	27.3	10.0-6C-F	20178916	54.0
5.6-3C-SD	20179335	11.1	8.5-5C-E	20179467	30.8	10.0-7C-F	20178917	58.3
5.6-4C-SD	20179337	12.8	8.5-6C-E	20179468	34.4	10.0-8C-F	20178918	62.6
6.0-3C-SF	20179369	9.4	8.5-7C-E	20179469	37.9	10.0-9C-J	20178919	69.9
6.0-4C-SF	20179371	10.9	8.5-8C-E	20179470	41.5	10.0-10C-J	20178109	74.1
6.0-5C-SF	20179373	12.5	8.5-9C-E	20179471	45.0	10.0-12C-J	20178910	82.6
6.0-6C-SF	20179375	14.0	8.5-10C-E	20179462	48.6	10.5-1C-SF	20178922	17.4
7.0-1C-SF	20179416	9.7	9.0-1C-SF	20179484	13.7	10.5-2C-SF	20178923	23.2
7.0-2C-SF	20179418	12.4	9.0-2C-SF	20179487	18.2	10.5-3C-E	20178924	31.4
7.0-3C-SF	20179420	15.2	9.0-3C-E	20179489	26.9	10.5-4C-E	20178925	35.9
7.0-4C-SF	20179422	18.0	9.0-4C-E	20179491	30.7	10.5-5C-E	20178926	40.4
7.0-5C-SF	20179424	20.8	9.0-5C-E	20179492	34.5	10.5-6C-F	20178927	60.0
7.0-6C-SF	20179426	23.6	9.0-6C-F	20179493	43.0	10.5-7C-F	20178928	64.5
7.0-7C-SF	20179428	26.4	9.0-7C-F	20179494	46.7	10.5-8C-F	20178929	69.0
7.0-8C-SF	20179430	29.2	9.0-8C-F	20179495	50.5	10.5-9C-J	20178930	77.7
7.5-1C-SF	20179440	11.4	9.0-9C-J	20179496	54.0	10.5-10C-J	20178920	82.2
7.5-2C-SF	20179441	14.4	9.0-10C-J	20179481	59.6	10.5-12C-J	20178921	91.2
7.5-3C-SF	20179442	17.5	9.0-12C-J	20179482	64.8	11.0-1C-SF	20178935	15.4
7.5-4C-SF	20179443	20.5	9.5-1C-SF	20179508	15.1	11.0-2C-SF	20178937	19.5
7.5-5C-SF	20179444	23.6	9.5-2C-SF	20179509	20.1	11.0-3C-E	20178939	33.6
7.5-6C-SF	20179445	26.6	9.5-3C-E	20179510	30.6	11.0-4C-E	20178941	38.4
8.0-1C-SF	20179448	13.0	9.5-4C-E	20179511	34.9	11.0-5C-E	20178943	43.1
8.0-2C-SF	20179450	16.3	9.5-5C-E	20179512	39.1	11.0-6C-F	20178945	66.2
8.0-3C-E	20179452	20.7	9.5-6C-F	20179513	49.1	11.0-7C-F	20178947	70.9
8.0-4C-E	20179454	24.0	9.5-7C-F	20179514	53.3	11.0-8C-F	20178949	75.6
8.0-5C-E	20179456	27.3	9.5-8C-F	20179515	57.6	11.0-9C-J	20178950	85.9
8.0-6C-E	20179458	30.6	9.5-9C-J	20179516	63.6	11.0-10C-J	20178932	90.6
8.0-7C-E	20179459	34.0	9.5-10C-J	20179506	67.8	11.0-12C-J	20178933	100.1
8.0-8C-E	20179460	37.3	9.5-12C-J	20179507	76.2	12.0-1C-SF	20178955	16.9
8.0-9C-E	20179461	40.6	10.0-1C-SF	20178911	16.1	12.0-2C-SF	20178956	21.7
8.0-10C-E	20179446	43.9	10.0-2C-SF	20178912	21.4	12.0-3C-E	20178957	38.4
8.5-1C-SF	20179463	12.6	10.0-3C-E	20178913	33.8	12.0-4C-E	20178959	43.6

*Weight does not include bushing and is approximate.

continued on page 113

Metal Sheaves and Pulleys

Available Parts

"C" Classical (Conventional) Sheaves (continued)

Part #	SAP #	Weight*	Part #	SAP #	Weight*	Part #	SAP #	Weight*
12.0-5C-E	20178961	48.8	18.0-1C-SF	20179097	27.8	27.0-9C-J	20179191	226.8
12.0-6C-F	20178963	62.5	18.0-2C-SF	20179099	42.2	30.0-2C-F	20179216	82.4
12.0-7C-F	20178965	67.7	18.0-3C-E	20179100	58.6	30.0-3C-F	20179218	115.4
12.0-8C-F	20178966	72.9	18.0-4C-E	20179102	68.6	30.0-4C-F	20179220	136.1
12.0-9C-J	20178968	103.1	18.0-5C-E	20179104	79.1	30.0-5C-F	20179222	160.8
12.0-10C-J	20178951	108.4	18.0-6C-F	20179106	98.3	30.0-6C-J	20179224	192.7
2.0-12C-J	20178953	118.8	18.0-7C-F	20179108	113.9	30.0-7C-J	20179226	220.8
13.0-1C-SF	20178982	18.5	18.0-8C-F	20179109	123.3	30.0-8C-J	20179228	240.0
13.0-2C-SF	20178983	23.9	18.0-9C-J	20179111	139.3	30.0-9C-M	20179229	316.8
13.0-3C-E	20178984	42.4	18.0-10C-J	20179093	148.7	30.0-10C-M	20179212	332.1
13.0-4C-E	20178986	49.4	18.0-12C-J	20179095	172.0	30.0-12C-M	20179213	362.7
13.0-5C-E	20178988	55.1	20.0-1C-SF	20179127	31.8	36.0-3C-F	20179239	161.7
13.0-6C-F	20178990	70.0	20.0-2C-SF	20179129	42.1	36.0-4C-F	20179240	194.2
13.0-7C-F	20178992	75.6	20.0-3C-E	20179131	62.6	36.0-5C-J	20179241	220.3
13.0-8C-F	20178993	81.3	20.0-4C-E	20179133	76.9	36.0-6C-J	20179242	254.5
13.0-9C-J	20178995	95.9	20.0-5C-F	20179136	96.5	36.0-7C-J	20179243	273.1
13.0-10C-J	20178978	101.6	20.0-6C-F	20179139	109.8	36.0-8C-M	20179244	355.3
13.0-12C-J	20178980	116.4	20.0-7C-J	20179142	139.3	36.0-9C-M	20179245	379.0
14.0-1C-SF	20179016	20.3	20.0-8C-J	20179144	146.5	36.0-10C-M	20179237	397.5
14.0-2C-SF	20179017	25.9	20.0-9C-J	20179146	159.2	36.0-12C-M	20179238	434.5
14.0-3C-E	20179018	41.7	20.0-10C-J	20179122	169.7	44.0-3C-F	20179294	242.8
14.0-4C-E	20179020	50.7	20.0-12C-M	20179124	257.4	44.0-4C-J	20179295	270.4
14.0-5C-E	20179022	57.2	24.0-1C-SF	20333017	41.2	44.0-5C-J	20179296	293.2
14.0-6C-F	20179024	73.0	24.0-2C-SF	20179156	57.6	44.0-6C-J	20179297	315.9
14.0-7C-F	20179026	81.8	24.0-3C-E	20179157	78.7	44.0-7C-M	20179298	429.2
14.0-8C-F	20179027	88.0	24.0-4C-F	20179159	100.4	44.0-8C-M	20179299	452.0
14.0-9C-J	20179029	104.5	24.0-5C-F	20179161	106.7	44.0-9C-M	20179300	474.6
14.0-10C-J	20179012	110.8	24.0-6C-F	20179163	122.1	44.0-10C-M	20179292	531.8
14.0-12C-J	20179014	127.3	24.0-7C-J	20179165	168.5	44.0-12C-M	20179293	577.3
16.0-1C-SF	20179066	23.5	24.0-8C-J	20179166	173.4	50.0-3C-F	20179353	304.1
16.0-2C-SF	20179068	32.2	24.0-9C-J	20179167	191.7	50.0-4C-J	20179354	337.4
16.0-3C-E	20179070	49.8	24.0-10C-M	20179154	263.1	50.0-5C-J	20179355	365.8
16.0-4C-E	20179073	60.2	24.0-12C-M	20179155	286.2	50.0-6C-M	20179356	484.4
16.0-5C-E	20179076	71.2	27.0-2C-F	20179179	79.4	50.0-7C-M	20179357	512.8
16.0-6C-F	20179079	87.7	27.0-3C-F	20179180	103.0	50.0-8C-M	20179358	541.1
16.0-7C-F	20179082	100.7	27.0-4C-F	20179182	116.8	50.0-9C-M	20179359	569.5
16.0-8C-F	20179084	108.6	27.0-5C-F	20179184	129.2	50.0-10C-M	20179351	662.9
16.0-9C-J	20179086	130.2	27.0-6C-J	20179186	158.8	50.0-12C-M	20179352	719.6
16.0-10C-J	20179061	141.3	27.0-7C-J	20179188	195.8			
16.0-12C-J	20179063	160.3	27.0-8C-J	20179189	226.3			

*Weight does not include bushing and is approximate.

“D” Classical (Conventional) Sheaves

Part #	SAP #	Weight*	Part #	SAP #	Weight*	Part #	SAP #	Weight*
12.0-3D-F	20178958	59.2	15.0-8D-J	20179043	149.7	22.0-6D-M	20179152	250.9
12.0-4D-F	20178960	69.0	15.0-10D-M	20179037	257.2	22.0-8D-M	20179153	318.5
12.0-5D-F	20178962	79.4	15.0-12D-M	20179038	281.2	22.0-10D-M	20179147	368.3
12.0-6D-J	20178964	105.9	15.5-3D-F	20179055	80.4	22.0-12D-M	20179148	412.2
12.0-8D-J	20178967	124.5	15.5-4D-F	20179056	92.8	24.0-3D-J	20179158	140.3
12.0-10D-M	20178952	157.5	15.5-5D-F	20179057	108.0	24.0-4D-J	20179160	176.3
12.0-12D-M	20178954	176.1	15.5-6D-J	20179058	132.9	24.0-5D-J	20179162	200.2
13.0-3D-F	20178985	63.0	15.5-8D-J	20179059	159.2	24.0-6D-M	20179164	278.4
13.0-4D-F	20178987	74.8	15.5-10D-M	20179053	275.5	27.0-3D-J	20179181	167.5
13.0-5D-F	20178989	85.1	15.5-12D-M	20179054	300.4	27.0-4D-J	20179183	199.5
13.0-6D-J	20178991	104.3	16.0-3D-F	20179071	84.3	27.0-5D-M	20179185	290.1
13.0-8D-J	20178994	124.2	16.0-4D-F	20179074	97.1	27.0-6D-M	20179187	319.6
13.0-10D-M	20178979	189.2	16.0-5D-F	20179077	113.1	27.0-8D-M	20179190	391.7
13.0-12D-M	20178981	209.7	16.0-6D-J	20179080	139.0	27.0-10D-M	20179177	450.8
13.5-3D-F	20178998	66.2	16.0-8D-J	20179085	166.3	27.0-12D-N	20179178	560.0
13.5-4D-F	20178999	78.7	16.0-10D-M	20179062	253.2	33.0-3D-J	20179232	218.9
13.5-5D-F	20179000	89.4	16.0-12D-M	20179064	278.9	33.0-4D-M	20179233	315.0
13.5-6D-J	20179001	109.8	17.0-4D-J	20179089	110.9	33.0-5D-M	20179234	352.9
13.5-8D-J	20179002	130.4	17.0-5D-J	20179090	128.1	33.0-6D-M	20179235	427.7
13.5-10D-M	20178996	205.4	17.0-6D-J	20179091	145.3	33.0-8D-M	20179236	489.3
13.5-12D-M	20178997	226.8	17.0-8D-J	20179092	176.3	33.0-10D-N	20179230	641.7
14.0-3D-F	20179019	69.4	17.0-10D-M	20179087	261.0	33.0-12D-N	20179231	729.3
14.0-4D-F	20179021	82.7	17.0-12D-M	20179088	288.6	40.0-3D-J	20179287	267.4
14.0-5D-F	20179023	93.9	18.0-3D-J	20179101	109.0	40.0-4D-M	20179288	380.1
14.0-6D-J	20179025	115.4	18.0-4D-J	20179103	129.0	40.0-5D-M	20179289	445.4
14.0-8D-J	20179028	136.7	18.0-5D-J	20179105	144.9	40.0-6D-M	20179290	498.4
14.0-10D-M	20179013	222.1	18.0-6D-J	20179107	165.0	40.0-8D-N	20179291	653.3
14.0-12D-M	20179015	244.4	18.0-8D-M	20179110	242.1	40.0-10D-N	20179285	814.0
14.5-3D-F	20179032	72.8	18.0-10D-M	20179094	276.3	40.0-12D-P	20179286	938.3
14.5-4D-F	20179033	86.8	18.0-12D-M	20179096	308.1	48.0-5D-M	20179303	586.8
14.5-5D-F	20179034	100.8	20.0-4D-J	20179134	135.4	48.0-6D-M	20179304	660.6
14.5-6D-J	20179035	121.1	20.0-5D-J	20179137	154.6	48.0-8D-N	20179305	820.8
14.5-8D-J	20179036	143.1	20.0-6D-J	20179140	173.7	48.0-10D-P	20179301	987.0
14.5-10D-M	20179030	239.4	20.0-8D-M	20179145	271.4	48.0-12D-P	20179302	1175.4
14.5-12D-M	20179031	262.5	20.0-10D-M	20179123	311.7	58.0-5D-M	20179362	698.2
15.0-3D-F	20179039	78.9	20.0-12D-M	20179125	351.8	58.0-6D-N	20179363	862.9
15.0-4D-F	20179040	91.0	22.0-3D-J	20179149	126.7	58.0-8D-N	20179364	1063.6
15.0-5D-F	20179041	105.7	22.0-4D-J	20179150	159.8	58.0-10D-P	20179360	1253.0
15.0-6D-J	20179042	126.9	22.0-5D-J	20179151	181.4	58.0-12D-P	20179361	1454.8

*Weight does not include bushing and is approximate.

Metal Sheaves and Pulleys

Available Parts

QT Sheaves - Single A Groove

Part #	SAP #	Weight*	Part #	SAP #	Weight*	Part #	SAP #	Weight*
AK30-QT	20179574	1.1	AK59-QT	20179585	2.4	AK99-QT	20179596	4.7
AK32-QT	20179575	1.2	AK61-QT	20179586	2.5	AK104-QT	20179566	4.5
AK34-QT	20179576	1.2	AK64-QT	20179587	2.7	AK109-QT	20179567	5.1
AK39-QT	20179577	1.4	AK66-QT	20179588	2.8	AK114-QT	20179568	5.5
AK41-QT	20179578	1.6	AK69-QT	20179589	3.2	AK124-QT	20179569	6.1
AK44-QT	20179579	1.9	AK71-QT	20179590	3.1	AK134-QT	20179570	7.4
AK46-QT	20179580	1.9	AK74-QT	20179591	3.3	AK144-QT	20179571	7.8
AK49-QT	20179581	2.1	AK79-QT	20179592	3.5	AK154-QT	20179572	8.8
AK51-QT	20179582	2.3	AK84-QT	20179593	3.6	AK184-QT	20179573	11.3
AK54-QT	20179583	2.0	AK89-QT	20179594	4.0			
AK56-QT	20179584	2.3	AK94-QT	20179595	4.4			

*Weight does not include bushing and is approximate.

QT Sheaves - Two A Groove

Part #	SAP #	Weight*	Part #	SAP #	Weight*	Part #	SAP #	Weight*
2AK30-QT	20179524	1.4	2AK51-QT	20179532	3.2	2AK94-QT	20179540	6.1
2AK32-QT	20179525	1.7	2AK54-QT	20179533	3.4	2AK104-QT	20179517	7.7
2AK34-QT	20179526	1.8	2AK56-QT	20179534	3.6	2AK114-QT	20179518	8.5
2AK39-QT	20179527	1.8	2AK59-QT	20179535	3.4	2AK124-QT	20179519	9.5
2AK41-QT	20179528	1.9	2AK61-QT	20179536	4.4	2AK134-QT	20179520	11.4
2AK44-QT	20179529	2.4	2AK64-QT	20179537	3.9	2AK144-QT	20179521	11.9
2AK46-QT	20179530	2.5	2AK74-QT	20179538	4.9	2AK154-QT	20179522	13.3
2AK49-QT	20179531	3.1	2AK84-QT	20179539	4.8	2AK184-QT	20179523	16.8

*Weight does not include bushing and is approximate.

QT Sheaves - Single B Groove

Part #	SAP #	Weight*	Part #	SAP #	Weight*	Part #	SAP #	Weight*
BK30-QT	20179607	1.2	BK60-QT	20179618	2.5	BK95-QT	20179629	5.0
BK32-QT	20179608	1.4	BK62-QT	20179619	2.6	BK100-QT	20179597	5.2
BK34-QT	20179609	1.6	BK65-QT	20179620	2.8	BK105-QT	20179598	5.5
BK36-QT	20179610	1.2	BK67-QT	20179621	2.9	BK110-QT	20179599	6.0
BK40-QT	20179611	1.4	BK70-QT	20179622	2.8	BK115-QT	20179600	6.4
BK45-QT	20179612	1.8	BK72-QT	20179623	3.1	BK120-QT	20179601	6.9
BK47-QT	20179613	2.2	BK75-QT	20179624	3.3	BK130-QT	20179602	6.9
BK50-QT	20179614	2.0	BK77-QT	20179625	3.6	BK140-QT	20179603	8.5
BK52-QT	20179615	2.1	BK80-QT	20179626	3.4	BK150-QT	20179604	9.5
BK55-QT	20179616	2.7	BK85-QT	20179627	3.6	BK160-QT	20179605	9.8
BK57-QT	20179617	2.7	BK90-QT	20179628	4.3	BK190-QT	20179606	12.8

*Weight does not include bushing and is approximate.

QT Sheaves – Two B Groove

Part #	SAP #	Weight*	Part #	SAP #	Weight*	Part #	SAP #	Weight*
2BK32-QT	20179548	2.0	2BK57-QT	20179557	4.3	2BK100-QT	20179541	8.4
2BK34-QT	20179549	2.4	2BK60-QT	20179558	4.4	2BK110-QT	20179542	9.3
2BK36-QT	20179550	2.0	2BK62-QT	20179559	4.5	2BK120-QT	20179543	11.0
2BK40-QT	20179551	2.4	2BK65-QT	20179560	4.5	2BK130-QT	20179544	13.1
2BK45-QT	20179552	3.0	2BK67-QT	20179561	5.0	2BK140-QT	20179545	14.8
2BK47-QT	20179553	2.8	2BK70-QT	20179562	5.1	2BK160-QT	20179546	17.5
2BK50-QT	20179554	3.3	2BK72-QT	20179563	5.4	2BK190-QT	20179547	21.5
2BK52-QT	20179555	3.6	2BK80-QT	20179564	6.4			
2BK55-QT	20179556	3.9	2BK90-QT	20179565	7.6			

*Weight does not include bushing and is approximate.

FHP Bored-to-Size Single A Groove Sheaves

Part #	SAP #	Weight*	Part #	SAP #	Weight*	Part #	SAP #	Weight*
AK15-1/2	20179929	0.3	AK25-5/8	20179969	31.3	AK35-3/4	20180002	62.3
AK15-5/8	20179930	1.3	AK25-3/4	20179968	32.3	AK35-7/8	20180004	63.3
AK16-1/2	20179935	2.3	AK25-7/8	20179970	33.3	AK35-1	20180000	64.3
AK16-5/8	20179936	3.3	AK26-1/2	20179971	34.3	AK39-1/2	20180006	65.3
AK17-1/2	20179937	4.3	AK26-5/8	20179973	35.3	AK39-5/8	20180008	66.3
AK17-5/8	20179939	5.3	AK26-3/4	20179972	36.3	AK39-3/4	20180007	67.3
AK17-3/4	20179938	6.3	AK27-1/2	20179975	37.3	AK39-7/8	20180009	68.3
AK18-5/8	20179940	7.3	AK27-5/8	20179977	38.3	AK39-15/16	20180011	69.3
AK19-1/2	20179945	8.3	AK27-3/4	20179976	39.3	AK39-1	20180005	70.3
AK19-5/8	20179947	9.3	AK27-1	20179974	40.3	AK41-1/2	20180014	71.3
AK19-3/4	20179946	10.3	AK28-1/2	20179979	41.3	AK41-5/8	20180017	72.3
AK19-7/8	20179948	11.3	AK28-5/8	20179981	42.3	AK41-3/4	20180016	73.3
AK20-1/2	20179949	12.3	AK28-3/4	20179980	43.3	AK41-7/8	20180018	74.3
AK20-5/8	20179951	13.3	AK28-7/8	20179982	44.3	AK41-15/16	20180015	75.3
AK20-3/4	20179950	14.3	AK30-1/2	20179984	45.3	AK41-1	20180012	76.3
AK21-1/2	20179952	15.3	AK30-5/8	20179986	46.3	AK41-1 1/8	20180013	77.3
AK21-5/8	20179954	16.3	AK30-3/4	20179985	47.3	AK44-1/2	20180021	78.3
AK21-3/4	20179953	17.3	AK30-7/8	20179987	48.3	AK44-5/8	20180023	79.3
AK22-1/2	20179955	18.3	AK30-1	20179983	49.3	AK44-3/4	20180022	80.3
AK22-5/8	20179957	19.3	AK32-1/2	20179989	50.3	AK44-7/8	20180024	81.3
AK22-3/4	20179956	20.3	AK32-5/8	20179991	51.3	AK44-15/16	20180025	82.3
AK22-7/8	20179958	21.3	AK32-3/4	20179990	52.3	AK44-1	20180019	83.3
AK23-1/2	20179959	22.3	AK32-7/8	20179992	53.3	AK44-1 1/8	20180020	84.3
AK23-5/8	20179961	23.3	AK32-1	20179988	54.3	AK46-1/2	20180028	85.3
AK23-3/4	20179960	24.3	AK34-1/2	20179996	55.3	AK46-5/8	20180030	86.3
AK24-1/2	20179963	25.3	AK34-5/8	20179998	56.3	AK46-3/4	20180029	87.3
AK24-5/8	20179965	26.3	AK34-3/4	20179997	57.3	AK46-7/8	20180031	88.3
AK24-3/4	20179964	27.3	AK34-7/8	20179999	58.3	AK46-15/16	20180032	89.3
AK24-7/8	20179966	28.3	AK34-1	20179994	59.3	AK46-1	20180026	90.3
AK24-1	20179962	29.3	AK35-1/2	20180001	60.3	AK46-1 1/8	20180027	91.3
AK25-1/2	20179967	30.3	AK35-5/8	20180003	61.3	AK49-1/2	20180035	92.3

*Weight does not include bushing and is approximate.

continued on page 117

Metal Sheaves and Pulleys

Available Parts

FHP Bored-to-Size Single A Groove Sheaves (continued)

Part #	SAP #	Weight*	Part #	SAP #	Weight*	Part #	SAP #	Weight*
AK49-5/8	20180038	93.3	AK64-15/16	20180085	141.3	AK94-5/8	20180135	189.3
AK49-3/4	20180037	94.3	AK64-1	20180078	142.3	AK94-3/4	20180134	190.3
AK49-7/8	20180039	95.3	AK64-1 1/8	20180079	143.3	AK94-15/16	20180136	191.3
AK49-15/16	20180036	96.3	AK64-1 3/16	20180080	144.3	AK94-1	20180129	192.3
AK49-1	20180033	97.3	AK66-5/8	20180089	145.3	AK94-1 3/16	20180131	193.3
AK49-1 1/8	20180034	98.3	AK66-3/4	20180088	146.3	AK94-1 1/4	20180130	194.3
AK51-1/2	20180042	99.3	AK66-1	20180086	147.3	AK94-1 7/16	20180132	195.3
AK51-5/8	20180044	100.3	AK66-1 1/8	20180087	148.3	AK99-3/4	20180139	196.3
AK51-3/4	20180043	101.3	AK69-3/4	20180092	149.3	AK99-1	20180137	197.3
AK51-7/8	20180045	102.3	AK69-1	20180090	150.3	AK99-1 7/16	20180138	198.3
AK51-1	20180040	103.3	AK69-1 1/8	20180091	151.3	AK104-5/8	20179903	199.3
AK51-1 1/8	20180041	104.3	AK71-1/2	20180096	152.3	AK104-3/4	20179902	200.3
AK54-1/2	20180048	105.3	AK71-5/8	20180098	153.3	AK104-1	20179897	201.3
AK54-5/8	20180051	106.3	AK71-3/4	20180097	154.3	AK104-1-3/16	20179899	202.3
AK54-3/4	20180050	107.3	AK71-1	20180093	155.3	AK104-1-1/4	20179898	203.3
AK54-7/8	20180052	108.3	AK71-1 1/8	20180094	156.3	AK104-1-3/8	20179900	204.3
AK54-15/16	20180049	109.3	AK71-1 7/16	20180095	157.3	AK104-1-7/16	20179901	205.3
AK54-1	20180046	110.3	AK74-1/2	20180104	158.3	AK109-3/4	20179906	206.3
AK54-1 1/8	20180053	111.3	AK74-5/8	20180106	159.3	AK109-1	20179904	207.3
AK54-1 3/16	20180047	112.3	AK74-3/4	20180105	160.3	AK109-1 3/8	20179907	208.3
AK56-1/2	20180057	113.3	AK74-15/16	20180107	161.3	AK109-1-7/16	20179905	209.3
AK56-5/8	20180059	114.3	AK74-1	20180099	162.3	AK114-3/4	20179911	210.3
AK56-3/4	20180058	115.3	AK74-1 1/8	20180101	163.3	AK114-1	20179908	211.3
AK56-7/8	20180060	116.3	AK74-1 3/16	20180102	164.3	AK114-1-3/16	20179909	212.3
AK56-15/16	20180061	117.3	AK74-1 1/4	20180100	165.3	AK114-1-7/16	20179910	213.3
AK56-1	20180054	118.3	AK74-1 7/16	20180103	166.3	AK124-5/8	20179917	214.3
AK56-1 1/8	20180055	119.3	AK79-3/4	20180110	167.3	AK124-3/4	20179916	215.3
AK56-1 3/16	20180056	120.3	AK79-1	20180108	168.3	AK124-1	20179912	216.3
AK59-1/2	20180064	121.3	AK79-1 1/8	20180109	169.3	AK124-1 3/16	20179913	217.3
AK59-5/8	20180067	122.3	AK79-1 7/16	20180111	170.3	AK124-1-1/4	20179914	218.3
AK59-3/4	20180066	123.3	AK81-5/8	20180115	171.3	AK124-1-7/16	20179915	219.3
AK59-7/8	20180068	124.3	AK81-3/4	20180114	172.3	AK134-3/4	20179922	220.3
AK59-15/16	20180069	125.3	AK81-1	20180112	173.3	AK134-1	20179918	221.3
AK59-1	20180062	126.3	2AK84-1 3/16	20179764	174.3	AK134-1-3/16	20179919	222.3
AK59-1-1/8	20180065	127.3	AK84-1/2	20180120	175.3	AK134-1-3/8	20179920	223.3
AK59-1 3/16	20180063	128.3	AK84-5/8	20180122	176.3	AK134-1-7/16	20179921	224.3
AK61-1/2	20180073	129.3	AK84-3/4	20180121	177.3	AK144-3/4	20179928	225.3
AK61-5/8	20180075	130.3	AK84- 15/16	20180116	178.3	AK144-1	20179925	226.3
AK61-3/4	20180074	131.3	AK84-1	20180117	179.3	AK144-1-3/16	20179926	227.3
AK61-7/8	20180076	132.3	AK84-1 3/16	20180118	180.3	AK144-1-7/16	20179927	228.3
AK61-15/16	20180077	133.3	AK84-1 7/16	20180119	181.3	AK154-3/4	20179934	229.3
AK61-1	20180070	134.3	AK89-3/4	20180126	182.3	AK154-1	20179931	230.3
AK61-1 1/8	20180071	135.3	AK89-1	20180123	183.3	AK154-1-7/16	20179933	231.3
AK61-1 3/16	20180072	136.3	AK89-1 1/8	20180124	184.3	AK184-3/4	20179944	232.3
AK64-1/2	20180081	137.3	AK89-1 7/16	20180125	185.3	AK184-1	20179941	233.3
AK64-5/8	20180083	138.3	AK91-3/4	20180128	186.3	AK184-1-3/16	20179942	234.3
AK64-3/4	20180082	139.3	AK91-1	20180127	187.3	AK184-1-7/16	20179943	235.3
AK64-7/8	20180084	140.3	AK94-1/2	20180133	188.3			

*Weight does not include bushing and is approximate.

FHP Bored-to-Size Single B Groove Sheaves

Part #	SAP #	Weight*	Part #	SAP #	Weight*	Part #	SAP #	Weight*
BK19-5/8	20180181	0.7	BK34-1	20180240	1.8	BK55-1	20180288	4.0
BK19-3/4	20180180	0.7	BK34-1 1/8	20180241	1.8	BK55-1 1/8	20180289	4.0
BK22-1/2	20180190	0.9	BK36-1/2	20180248	2.0	BK55-1 3/16	20180290	4.0
BK22-5/8	20180192	0.9	BK36-5/8	20180250	2.0	BK57/HA54 5/8	20180295	4.1
BK22-3/4	20180191	0.9	BK36-3/4	20180249	2.0	K57-3/4	20180298	4.1
BK22-7/8	20180193	0.9	BK36-7/8	20180251	2.0	BK57-7/8	20180299	4.1
BK22-1	20180189	0.9	BK36-1	20180246	2.0	BK57-15/16	20180300	4.1
BK23-5/8	20180194	0.9	BK36-1 1/8	20180247	2.0	BK57-1	20180296	4.1
BK23-1	20180195	0.9	BK40-1/2	20180254	2.2	BK57-1 1/8	20180297	4.1
BK24-1/2	20180200	0.9	BK40-5/8	20180256	2.2	BK60-1/2	20180303	3.8
BK24-5/8	20180202	0.9	BK40-3/4	20180255	2.2	BK60-5/8	20180306	3.8
BK24-3/4	20180201	0.9	BK40-7/8	20180257	2.2	BK60-3/4	20180305	3.8
BK24-7/8	20180203	0.9	BK40-1	20180252	2.2	BK60-7/8	20180307	3.8
BK24-1	20180199	0.9	BK40-1 1/8	20180253	2.2	BK60-1	20180301	3.8
BK25-1/2	20180204	1.1	BK45-1/2	20180260	2.7	BK60-1-1/8	20180304	3.8
BK25-5/8	20180206	1.1	BK45-5/8	20180262	2.7	BK60-1 3/16	20180302	3.8
BK25-3/4	20180205	1.1	BK45-3/4	20180261	2.7	BK62-1/2	20180311	3.6
BK25-7/8	20180207	1.1	BK45-7/8	20180263	2.7	BK62-5/8	20180313	3.6
BK26-1/2	20180208	1.2	BK45-1	20180258	2.7	BK62-3/4	20180312	3.6
BK26-5/8	20180210	1.2	BK45-1 1/8	20180259	2.7	BK62-7/8	20180314	3.6
BK26-3/4	20180209	1.2	BK46-7/8	20180264	2.7	BK62-15/16	20180315	3.6
BK26-7/8	20180211	1.2	BK47-1/2	20180267	2.9	BK62-1	20180308	3.6
BK27-1/2	20180213	1.1	BK47-5/8	20180269	2.9	BK62-1 1/8	20180309	3.6
BK27-5/8	20180215	1.1	BK47-3/4	20180268	2.9	BK62-1 13/16	20333018	3.6
BK27-3/4	20180214	1.1	BK47-7/8	20180270	2.9	BK64-5/8	20180318	3.7
BK27-7/8	20180216	1.1	BK47-1	20180265	2.9	BK64-3/4	20333019	3.7
BK27-1 1/8	20180212	1.1	BK47-1 1/8	20180266	2.9	BK64-7/8	20180319	3.7
BK28-1/2	20180219	1.4	BK48-5/8	20180273	3.0	BK65-5/8	20180323	3.7
BK28-5/8	20180221	1.4	BK48-3/4	20180272	3.0	BK65-3/4	20180322	3.7
BK28-3/4	20180220	1.4	BK48-7/8	20180274	3.0	BK65-1	20180320	3.7
BK28-7/8	20180222	1.4	BK48-1 1/8	20180271	3.0	BK65-1 1/8	20180321	3.7
BK28-1	20180217	1.4	BK50-1/2	20180277	3.2	BK67-5/8	20180327	3.7
BK28-1 1/8	20180218	1.4	BK50-5/8	20180279	3.2	BK67-3/4	20180326	3.7
BK30-1/2	20180225	1.5	BK50-3/4	20180278	3.2	BK67-1	20180324	3.7
BK30-5/8	20180227	1.5	BK50-7/8	20180280	3.2	BK67-1 1/8	20333020	3.7
BK30-3/4	20180226	1.5	BK50-15/16	20180281	3.2	BK70-5/8	20180335	3.7
BK30-7/8	20180228	1.5	BK50-1	20180275	3.2	BK70-3/4	20180334	3.7
BK30-1	20180223	1.5	BK50-1 1/8	20180276	3.2	BK70-15/16	20180336	3.7
BK30-1 1/8	20180224	1.5	BK52-1/2	20180284	3.4	BK70-1	20180330	3.7
BK32-1/2	20180236	1.5	BK52-5/8	20180286	3.4	BK70-1-1/8	20180332	3.7
BK32-5/8	20180238	1.5	BK52-3/4	20180285	3.4	BK70-1 13/16	20333021	3.7
BK32-3/4	20180237	1.5	BK52-7/8	20180287	3.4	BK70-1-7/16	20180333	3.7
BK32-7/8	20180239	1.5	BK52-1	20180282	3.4	BK72-3/4	20180341	3.8
BK32-1	20180235	1.5	BK52-1 1/8	20180283	3.4	BK72-1	20180337	3.8
BK34-1/2	20180242	1.8	BK55-1/2	20180291	4.0	BK72-1-1/8	20180339	3.8
BK34-5/8	20180244	1.8	BK55-5/8	20180293	4.0	BK72-1-3/8	20180340	3.8
BK34-3/4	20180243	1.8	BK55-3/4	20180292	4.0	BK72-1 7/16	20180338	3.8
BK34-7/8	20180245	1.8	BK55-7/8	20180294	4.0	BK75-3/4	20180345	4.3

*Weight does not include bushing and is approximate.

continued on page 119

Metal Sheaves and Pulleys

Available Parts

FHP Bored-to-Size Single B Groove Sheaves (continued)

Part #	SAP #	Weight*	Part #	SAP #	Weight*	Part #	SAP #	Weight*
BK75-1	20180342	4.3	BK90-1-3/16	20180368	6.0	BK115-1	20180157	8.7
BK75-1 1/8	20180343	4.3	BK90-1-3/8	20180369	6.0	BK115-1 3/8	20180158	8.7
BK75-1 7/16	20180344	4.3	BK90-1 7/16	20180372	6.0	BK115-1 7/16	20180159	8.7
BK77-3/4	20180350	4.5	BK92-3/4	20180379	6.2	BK120-3/4	20180164	9.2
BK77-1	20180346	4.5	BK92-7/8	20180380	6.2	BK120-1	20180160	9.2
BK77-1 1/8	20180347	4.5	BK92-1 1/8	20180376	6.2	BK120-1 13/16	20333024	9.2
BK77-1 3/8	20180348	4.5	BK95-3/4	20180385	6.3	BK120-1-3/8	20180163	9.2
BK77-1 7/16	20180349	4.5	BK95-1	20180381	6.3	BK120-1 7/16	20180162	9.2
BK80-5/8	20180358	5.1	BK95-1-1/8	20180383	6.3	BK130-3/4	20180168	9.6
BK80-3/4	20180357	5.1	BK95-1-3/8	20180384	6.3	BK130-1	20180165	9.6
BK80-7/8	20180359	5.1	BK95-1 7/16	20180382	6.3	BK130-1 1/8	20180170	9.6
BK80-1	20180351	5.1	BK100-3/4	20180146	7.2	BK130-1 13/16	20333025	9.6
BK80-1 1/8	20180353	5.1	BK100-7/8	20180147	7.2	BK130-1-7/16	20180167	9.6
BK85-1 3/16	20180362	5.1	BK100-1	20180140	7.2	BK140-3/4	20180174	11.2
BK80-1 1/4	20180352	5.1	BK100-1 1/8	20180141	7.2	BK140-1	20180171	11.2
BK80-1 3/8	20180355	5.1	BK100-1 3/16	20180142	7.2	BK140-1 13/16	20333026	11.2
BK80-1 7/16	20180356	5.1	BK100-1-1/4	20180144	7.2	BK140-1-7/16	20180173	11.2
BK85-3/4	20180365	5.5	BK100-1-3/8	20180145	7.2	BK160-1	20180175	12.9
BK85-1	20180360	5.5	BK100-1 7/16	20180143	7.2	BK160-1 1/8	20180177	12.9
BK85-1 1/8	20180361	5.5	BK105-1	20180148	7.7	BK160-1 13/16	20333027	12.9
BK85-1 13/16	20333022	5.5	BK105-1 3/8	20180149	7.7	BK160-1 1/4	20180176	12.9
BK85-1 3/8	20180363	5.5	BK105-1 7/16	20180150	7.7	BK160-1 7/16	20180179	12.9
BK85-1-7/16	20180364	5.5	BK110-3/4	20180156	8.2	BK190-1	20180182	14.5
BK90-3/4	20180370	6.0	BK110-1	20180151	8.2	BK190-1 13/16	20333028	14.5
BK90-7/8	20180371	6.0	BK110-1 1/8	20180152	8.2	BK190-1 1/4	20180183	14.5
BK90-15/16	20180373	6.0	BK110-1 13/16	20333023	8.2	BK190-1-7/16	20180184	14.5
BK90-1	20180366	6.0	BK110-1-3/8	20180154	8.2			
BK90-1-1/8	20180367	6.0	BK110-1-7/16	20180155	8.2			

*Weight does not include bushing and is approximate.

FHP Bored-to-Size Two A Groove Sheaves

Part #	SAP #	Weight*	Part #	SAP #	Weight*	Part #	SAP #	Weight*
2AK20-1/2	20179650	0.9	2AK25-3/4	20179667	1.5	2AK30-3/4	20179686	2.2
2AK20-5/8	20179652	0.9	2AK25-7/8	20179669	1.5	2AK30-7/8	20179688	2.2
2AK20-3/4	20179651	0.9	2AK25-1	20179666	1.5	2AK30-1	20179683	2.2
2AK21-1/2	20179654	1.1	2AK26-5/8	20179672	1.5	2AK30-1 1/8	20179684	2.2
2AK21-5/8	20179656	1.1	2AK26-3/4	20179671	1.5	2AK32-5/8	20179692	2.4
2AK21-3/4	20179655	1.1	2AK26-7/8	20179673	1.5	2AK32-3/4	20179691	2.4
2AK22-1/2	20179657	1.2	2AK27-5/8	20179676	1.8	2AK32-7/8	20179693	2.4
2AK22-5/8	20179659	1.2	2AK27-3/4	20179675	1.8	2AK32-1	20179689	2.4
2AK22-3/4	20179658	1.2	2AK27-7/8	20179677	1.8	2AK32-1 1/8	20179690	2.4
2AK22-7/8	20179660	1.2	2AK27-1	20179674	1.8	2AK34-5/8	20179697	2.7
2AK22-1	20179661	1.2	2AK28-5/8	20179681	2.0	2AK34-3/4	20179696	2.7
2AK23-5/8	20179664	1.3	2AK28-3/4	20179680	2.0	2AK34-7/8	20179698	2.7
2AK23-3/4	20179663	1.3	2AK28-7/8	20179682	2.0	2AK34-1	20179694	2.7
2AK23-7/8	20179665	1.3	2AK28-1	20179679	2.0	2AK34-1 1/8	20179695	2.7
2AK23-1	20179662	1.3	2AK30-1/2	20179685	2.2	2AK39-5/8	20179702	3.2
2AK25-5/8	20179668	1.5	2AK30-5/8	20179687	2.2	2AK39-3/4	20179701	3.2

*Weight does not include bushing and is approximate.

continued on page 120

FHP Bored-to-Size Two A Groove Sheaves (continued)

Part #	SAP #	Weight*	Part #	SAP #	Weight*	Part #	SAP #	Weight*
2AK39-7/8	20179703	3.2	2AK54-1	20179728	3.2	2AK84-1	20179759	6.9
2AK39-1	20179699	3.2	2AK54-1 1/8	20179729	3.2	2AK84-1-1/8	20179760	6.9
2AK39-1 1/8	20179700	3.2	2AK54-1 3/8	20179733	3.2	2AK84-1-3/8	20179761	6.9
2AK41-5/8	20179707	3.5	2AK56-5/8	20179738	3.3	2AK84-1-7/16	20179762	6.9
2AK41-3/4	20179706	3.5	2AK56-3/4	20179737	3.3	2AK94-3/4	20179771	7.7
2AK41-7/8	20179708	3.5	2AK56-1	20179734	3.3	2AK94-1	20179766	7.7
2AK41-1	20179704	3.5	2AK56-1 1/8	20179735	3.3	2AK94-1-1/8	20179767	7.7
2AK41-1 1/8	20179705	3.5	2AK56-1-3/8	20179736	3.3	2AK94-1-3/16	20179768	7.7
2AK44-5/8	20179712	4.1	2AK59-1	20179739	3.4	2AK94-1-3/8	20179769	7.7
2AK44-3/4	20179711	4.1	2AK59-1 1/8	20179740	3.4	2AK94-1-7/16	20179770	7.7
2AK44-7/8	20179713	4.1	2AK59-1-3/8	20179741	3.4	2AK104-3/4	20179633	9.7
2AK44-1	20179709	4.1	2AK61-3/4	20179745	3.6	2AK104-15/16	20179634	9.7
2AK44-1 1/8	20179710	4.1	2AK61-7/8	20179746	3.6	2AK104-1	20179630	9.7
2AK46-5/8	20179716	4.6	2AK61-1	20179742	3.6	2AK104-1 3/16	20179631	9.7
2AK46-7/8	20179717	4.6	2AK61-1 1/8	20179743	3.6	2AK104-1-7/16	20179632	9.7
2AK46-1	20179714	4.6	2AK61-1-3/8	20179744	3.6	2AK114-1	20179635	10.2
2AK46-1 1/8	20179715	4.6	2AK64-3/4	20179752	4.5	2AK114-1-3/16	20179636	10.2
2AK49-3/4	20179720	2.7	2AK64-1	20179747	4.5	2AK114-1-3/8	20179637	10.2
2AK49-7/8	20179721	2.7	2AK64-1 1/8	20179748	4.5	2AK114-1-7/16	20179638	10.2
2AK49-1	20179718	2.7	2AK64-1-3/16	20179749	4.5	2AK124-1	20179639	11.3
2AK49-1 1/8	20179719	2.7	2AK64-1-3/8	20179750	4.5	2AK124-1-3/16	20179640	11.3
2AK49-1 3/8	20179722	2.7	2AK64-1-7/16	20179751	4.5	2AK124-1-7/16	20179641	11.3
2AK51-3/4	20179726	2.9	2AK74-3/4	20179758	5.8	2AK134-1-3/16	20179642	12.4
2AK51-7/8	20179727	2.9	2AK74-1	20179753	5.8	2AK134-1-7/16	20179643	12.4
2AK51-1	20179723	2.9	2AK74-1-1/8	20179754	5.8	2AK144-1	20179644	13.2
2AK51-1 1/8	20179724	2.9	2AK74-1-3/16	20179755	5.8	2AK144-1 7/16	20179645	13.2
2AK51-1-3/8	20179725	2.9	2AK74-1-3/8	20179756	5.8	2AK154-1 3/16	20179646	13.7
2AK54-5/8	20179731	3.2	2AK74-1-7/16	20179757	5.8	2AK154-1 7/16	20179647	13.7
2AK54-3/4	20179730	3.2	2AK84-3/4	20179763	6.9	2AK184-1-3/16	20179648	15.8
2AK54-7/8	20179732	3.2	2AK84-15/16	20179765	6.9	2AK184-1-7/16	20179649	15.8

*Weight does not include bushing and is approximate.

FHP Bored-to-Size Two B Groove Sheaves

Part #	SAP #	Weight*	Part #	SAP #	Weight*	Part #	SAP #	Weight*
2BK23-5/8	20179794	1.3	2BK27-5/8	20179806	1.8	2BK30-1/2	20179817	1.9
2BK23-7/8	20179795	1.3	2BK27-3/4	20179805	1.8	2BK30-5/8	20179819	1.9
2BK25-1/2	20179796	1.4	2BK27-7/8	20179808	1.8	2BK30-3/4	20179818	1.9
2BK25-5/8	20179798	1.4	2BK27-1	20179807	1.8	2BK30-7/8	20179820	1.9
2BK25-3/4	20179797	1.4	2BK28-1/2	20179811	1.9	2BK30-1	20179815	1.9
2BK25-7/8	20179799	1.4	2BK28-5/8	20179813	1.9	2BK30-1 1/8	20179816	1.9
2BK26-5/8	20179802	1.6	2BK28-3/4	20179812	1.9	2BK32-5/8	20179824	2.2
2BK26-7/8	20179803	1.6	2BK28-7/8	20179814	1.9	2BK32-7/8	20179825	2.2
2BK26-1 1/8	20179801	1.6	2BK28-1	20179809	1.9	2BK32-1	20179821	2.2
2BK27-1/2	20179804	1.8	2BK28-1 1/8	20179810	1.9	2BK32-1 1/8	20179822	2.2

*Weight does not include bushing and is approximate.

continued on page 121

Bushings

Easy to Install and Remove

Sure-Grip®* “Quick Detachable” bushings are split through flange and taper to provide a true clamp on the shaft that is the equivalent of a shrink fit.

All bushing sizes, except JA and QT, have a setscrew over the key to help maintain the bushing's position on the shaft until the cap screws are securely tightened. Sure-Grip® bushings have a very gradual taper (3/4-inch taper per foot on the diameter), which is about half the inclined angle of many other bushings. The result is that the Sure-Grip® securely clamps the shaft, with twice the force of those competitive bushings, to provide extreme holding power.

Versatile Sure-Grip® bushings permit the mounting of the same mating part on shafts of different diameters and the mounting of different sheaves on the same shaft using the same bushing. Their interchangeability extends through sheaves, pulleys, timing pulleys, sprockets, flexible and rigid couplings, made-to-order items by Continental ContiTech and product lines of several other mechanical power transmission manufacturers.

Sure-Grip® bushings are manufactured with the drilled and tapped holes located at a precise distance from the keyseat; thus, a wide mating part having a bushing in each end can be mounted on a common shaft with the two keyways in line. This feature not only facilitates installation but also permits both bushings to carry an equal share of the load.

Available Sizes

Sure-Grip® Bushings		
QT*	SF	N
JA	E	P
SH	F	W
SDS	J	S
SK	M	

* "H" is a Split Taper Bushing. "QT" is a QD® Bushing and is interchangeable with an "H" bushing.

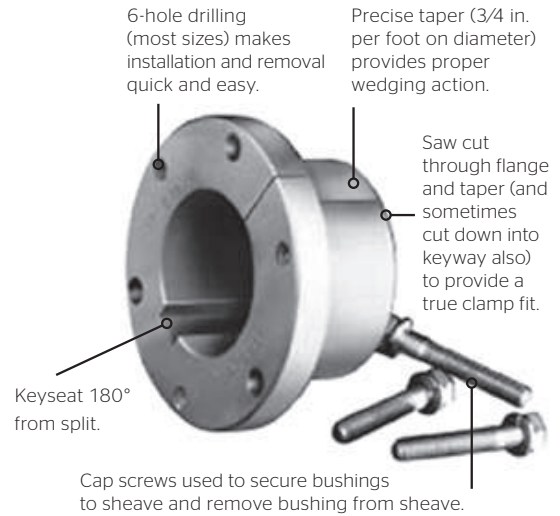

Sure-Grip® Bushings (Millimeter Bores-in. Bolt)

QT	SF	P
JA	E	SKL
SH	F	SFL
SDS	J	EL
SD	M	
SK	N	

Metric Sure-Grip® Bushings

QTMX	SDSMX	SFMX
JAMX	SDMX	EMX
SHMX	SKMX	FMX

Metric “L” Series Flangeless Bushings

SKLMX	ELMX	FLMX
SFLMX		

“L” Series Flangeless Bushings

EL	SKL	SFL
FL		

Sure-Grip® Idler Bushings & Replacement Bearings

SH-BB	SK-BB	E-BB
SD-BB	SF-BB	

Sure-Grip® Short Bushings

JS	NS	WS
MS	PS	

*Trademark of TB Wood's Incorporated.

General Product Information

Sure-Grip®* Bushings

- › Sure-Grip® bushings conform to the specifications set forth by the Mechanical Power Transmission Association (MPTA) in their CO-1 Guideline of October 1992.
- › An “MPB” or “Minimum Plain Bore” bushing is available in most bushing sizes. These bushings are unsplit and have no keyway. These bushings are intended for reboring and other alterations.
- › Sure-Grip® bushings for inch shafts conform to ANSI B17.1-1967, R1989 for key size versus shaft diameter and keyway dimensions. Square keys are used where possible. For larger bores where a square key is not possible, the required rectangular key is furnished with the bushing.
- › Sure-Grip® bushings for metric shafts conform to British Standard HS 4235: Part 1:1972 for key size versus shaft diameter and keyway dimensions. For larger bores where it is not possible to maintain the standard keyway depth, a more shallow keyway may be used. Special metric keys are not furnished with the bushing.

V-Belt Sheaves, Synchronous Belt Sprockets, Flat Belt Pulleys, etc.

Materials

- › The standard material is class 30 or higher cast iron. Products made from cast iron have a maximum speed limitation of 6,500 foot per minute at the outside diameter. Higher speed requirements dictate the use of higher strength materials.
- › For speeds up to 16,000 foot per minute or high shock application requiring greater toughness, special ductile iron products can be made.

Balance

- › The standard balance is a one-plane tolerance to a G26 quality grade based on 3,500 rpm or the maximum rated speed. A two-plane balance to a G6.3 quality grade is available at an added cost. Sure-Grip® bushed products, which are one-plane balanced, are marked so the bushing can be reinstalled at the application the same way it was installed for balancing. See MPTA SPB-95 for standard balancing practices.

Standards

- › The following products meet or exceed the noted ARPM design standards:

Classical V-Belt Sheaves	IP-20-2007
Narrow V-Belt Sheaves	IP-22-2007
Synchronous Belt Pulleys	IP-24-2010
Curvilinear Belt Sprockets	IP-27-2009
FHP Belts and Sheaves	IP-23-2009
Hex Belts and Sheaves	IP-21-2009
Variable Speed	IP-25-2010
V-Ribbed Belts	IP-26-2009

Special constructions available

We have the capability to assist in your design and quote any specially designed power transmission drive. We are able to offer consistently competitive prices and fast delivery on the following specials plus much more.

V-Belt Sheaves

- › Nonstandard diameter requirements
- › Nonstandard number of grooves
- › Unusual hub configurations
- › Deep grooves
- › Metric grooves
- › Added inertia or flywheel effect

Synchronous Sprockets

- › Nonstandard number of teeth
- › Nonstandard face widths
- › Unusual hub configurations
- › Special tooth profiles
- › Added inertia of flywheel effect

Flat Belt Pulleys

- › Nonstandard diameter requirements
- › Nonstandard face widths
- › Unusual hub configurations
- › Split through rim or arm designs
- › All types of special crowns
- › Added inertia or flywheel effect
- › Taper cone arrangements

Flywheels

- › Flywheels per customer design

*Trademark of TB Wood's Incorporated.

Bushings

Easy to Install and Remove

Sure-Grip®* “Quick Detachable” bushings are split through flange and taper to provide a true clamp on the shaft that is the equivalent of a shrink fit.

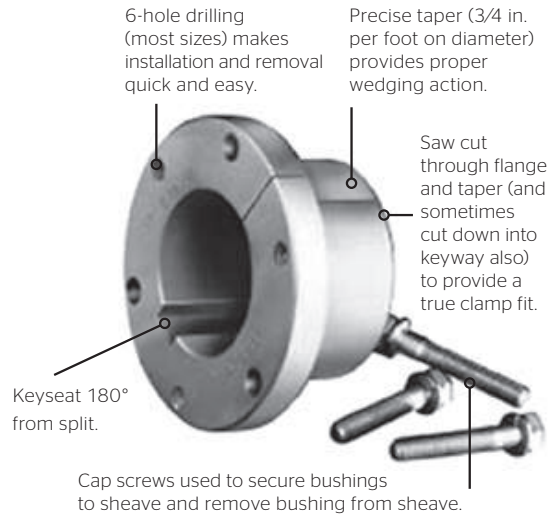

All bushing sizes, except JA and QT, have a setscrew over the key to help maintain the bushing’s position on the shaft until the cap screws are securely tightened. Sure-Grip® bushings have a very gradual taper (3/4-inch taper per foot on the diameter), which is about half the inclined angle of many other bushings. The result is that the Sure-Grip® securely clamps the shaft, with twice the force of those competitive bushings, to provide extreme holding power.

Versatile Sure-Grip® bushings permit the mounting of the same mating part on shafts of different diameters and the mounting of different sheaves on the same shaft using the same bushing. Their interchangeability extends through sheaves, pulleys, timing pulleys, sprockets, flexible and rigid couplings, made-to-order items by Continental ContiTech and product lines of several other mechanical power transmission manufacturers.

Sure-Grip® bushings are manufactured with the drilled and tapped holes located at a precise distance from the keyseat; thus, a wide mating part having a bushing in each end can be mounted on a common shaft with the two keyways in line. This feature not only facilitates installation but also permits both bushings to carry an equal share of the load.

Available Sizes

Sure-Grip® Bushings		
QT*	SF	N
JA	E	P
SH	F	W
SDS	J	S
SK	M	

*“H” is a Split Taper Bushing. “QT” is a QD® Bushing and is interchangeable with an “H” bushing.

Sure-Grip® Bushings (Millimeter Bores-in. Bolt)

QT	SF	P
JA	E	SKL
SH	F	SFL
SDS	J	EL
SD	M	
SK	N	

Metric Sure-Grip® Bushings

QTMX	SDSMX	SFMX
JAMX	SDMX	EMX
SHMX	SKMX	FMX

Metric “L” Series Flangeless Bushings

SKLMX	ELMX	FLMX
SFLMX		

“L” Series Flangeless Bushings

EL	SKL	SFL
FL		

Sure-Grip® Idler Bushings & Replacement Bearings

SH-BB	SK-BB	E-BB
SD-BB	SF-BB	

Sure-Grip® Short Bushings

JS	NS	WS
MS	PS	

*Trademark of TB Wood’s Incorporated.

General Product Information

Sure-Grip®* Bushings

- › Sure-Grip® bushings conform to the specifications set forth by the Mechanical Power Transmission Association (MPTA) in their CO-1 Guideline of October 1992.
- › An “MPB” or “Minimum Plain Bore” bushing is available in most bushing sizes. These bushings are unsplit and have no keyway. These bushings are intended for reboring and other alterations.
- › Sure-Grip® bushings for inch shafts conform to ANSI B17.1-1967, R1989 for key size versus shaft diameter and keyway dimensions. Square keys are used where possible. For larger bores where a square key is not possible, the required rectangular key is furnished with the bushing.
- › Sure-Grip® bushings for metric shafts conform to British Standard HS 4235: Part 1:1972 for key size versus shaft diameter and keyway dimensions. For larger bores where it is not possible to maintain the standard keyway depth, a more shallow keyway may be used. Special metric keys are not furnished with the bushing.

V-Belt Sheaves, Synchronous Belt Sprockets, Flat Belt Pulleys, etc.

Materials

- › The standard material is class 30 or higher cast iron. Products made from cast iron have a maximum speed limitation of 6,500 foot per minute at the outside diameter. Higher speed requirements dictate the use of higher strength materials.
- › For speeds up to 16,000 foot per minute or high shock application requiring greater toughness, special ductile iron products can be made.

Balance

- › The standard balance is a one-plane tolerance to a G26 quality grade based on 3,500 rpm or the maximum rated speed. A two-plane balance to a G6.3 quality grade is available at an added cost. Sure-Grip® bushed products, which are one-plane balanced, are marked so the bushing can be reinstalled at the application the same way it was installed for balancing. See MPTA SPB-95 for standard balancing practices.

Standards

- › The following products meet or exceed the noted ARPM design standards:

Classical V-Belt Sheaves	IP-20-2007
Narrow V-Belt Sheaves	IP-22-2007
Synchronous Belt Pulleys	IP-24-2010
Curvilinear Belt Sprockets	IP-27-2009
FHP Belts and Sheaves	IP-23-2009
Hex Belts and Sheaves	IP-21-2009
Variable Speed	IP-25-2010
V-Ribbed Belts	IP-26-2009

Special constructions available

We have the capability to assist in your design and quote any specially designed power transmission drive. We are able to offer consistently competitive prices and fast delivery on the following specials plus much more.

V-Belt Sheaves

- › Nonstandard diameter requirements
- › Nonstandard number of grooves
- › Unusual hub configurations
- › Deep grooves
- › Metric grooves
- › Added inertia or flywheel effect

Synchronous Sprockets

- › Nonstandard number of teeth
- › Nonstandard face widths
- › Unusual hub configurations
- › Special tooth profiles
- › Added inertia of flywheel effect

Flat Belt Pulleys

- › Nonstandard diameter requirements
- › Nonstandard face widths
- › Unusual hub configurations
- › Split through rim or arm designs
- › All types of special crowns
- › Added inertia or flywheel effect
- › Taper cone arrangements

Flywheels

- › Flywheels per customer design

*Trademark of TB Wood's Incorporated.

Bushing Hardware

Taper-Lock Bushings

Part #	SAP #	Weight	Part #	SAP #	Weight	Part #	SAP #	Weight
TL1008			TL1310			TL1615		
TL1008-1/2	20352765	0.3	TL1310-1/2	20352807	0.7	TL1615-1 5/16	20352860	0.8
TL1008-9/16	20352766	0.3	TL1310-9/16	20352808	0.7	TL1615-1 3/8	20352861	0.8
TL1008-5/8	20352767	0.3	TL1310-5/8	20352809	0.7	TL1615-1 7/16	20352862	0.7
TL1008-11/16	20352768	0.2	TL1310-11/16	20352810	0.7	TL1615-1 1/2	20352863	0.7
TL1008-3/4	20352769	0.2	TL1310-3/4	20352811	0.7	TL1615-1 5/8	20582854	0.4
TL1008-13/16	20352770	0.2	TL1310-13/16	20352812	0.7	TL2012		
TL1008-7/8	20352739	0.2	TL1310-7/8	20352813	0.7	TL2012-1/2	20352864	1.7
TL1108			TL1310-15/16	20352814	0.6	TL2012-9/16	20352865	1.7
TL1108-1/2	20352772	0.3	TL1310-1	20352815	0.6	TL2012-5/8	20352866	1.7
TL1108-9/16	20352773	0.3	TL1310-1 1/16	20352816	0.6	TL2012-11/16	20352867	1.7
TL1108-5/8	20352774	0.3	TL1310-1 1/8	20352817	0.6	TL2012-3/4	20352868	1.7
TL1108-11/16	20352775	0.2	TL1310-1 3/16	20352818	0.6	TL2012-13/16	20352869	1.7
TL1108-3/4	20352776	0.2	TL1310-1 1/4	20352819	0.6	TL2012-7/8	20352870	1.6
TL1108-13/16	20352777	0.2	TL1610			TL2012-15/16	20352871	1.6
TL1108-7/8	20352778	0.2	TL1610-1/2	20352820	0.9	TL2012-1	20352872	1.6
TL1108-15/16	20352779	0.2	TL1610-9/16	20352821	0.9	TL2012-1 1/16	20352873	1.6
TL1108-1	20352780	0.2	TL1610-5/8	20352822	0.9	TL2012-1 1/8	20352874	1.5
TL1108-1 1/8	20582850	0.4	TL1610-11/16	20352823	0.9	TL2012-1 3/16	20352875	1.5
TL1210			TL1610-3/4	20352824	0.9	TL2012-1 1/4	20352876	1.5
TL1210-1/2	20352781	0.6	TL1610-13/16	20352825	0.9	TL2012-1 5/16	20352877	1.4
TL1210-9/16	20352782	0.6	TL1610-7/8	20352826	0.8	TL2012-1 3/8	20352878	1.3
TL1210-5/8	20352783	0.6	TL1610-15/16	20352827	0.8	TL2012-1 7/16	20352879	1.2
TL1210-11/16	20352784	0.5	TL1610-1	20352828	0.8	TL2012-1 1/2	20352880	1.2
TL1210-3/4	20352785	0.5	TL1610-1 1/16	20352829	0.8	TL2012-1 9/16	20352881	1.2
TL1210-13/16	20352786	0.5	TL1610-1 1/8	20352830	0.7	TL2012-1 5/8	20352882	1.2
TL1210-7/8	20352787	0.5	TL1610-1 3/16	20352831	0.7	TL2012-1 11/16	20352883	1.1
TL1210-15/16	20352788	0.5	TL1610-1 1/4	20352832	0.7	TL2012-1 3/4	20352884	1
TL1210-1	20352789	0.5	TL1610-1 5/16	20352833	0.6	TL2012-1 13/16	20352885	1
TL1210-1 1/16	20352790	0.4	TL1610-1 3/8	20352834	0.6	TL2012-1 7/8	20352886	0.9
TL1210-1 1/8	20352791	0.4	TL1610-1 7/16	20352835	0.6	TL2012-1 15/16	20582855	0.4
TL1210-1 3/16	20352792	0.4	TL1610-1 1/2	20352836	0.5	TL2012-2 1/8	20582857	0.4
TL1210-1 1/4	20352793	0.4	TL1610-1 5/8	20582852	0.4	TL2012-2 3/16	20582875	0.4
TL1215			TL1615			TL2517		
TL1215-1/2	20352794	0.9	TL1615-1/2	20352837	1.3	TL2517-1/2	20352887	3.7
TL1215-9/16	20352795	0.9	TL1615-9/16	20352838	1.3	TL2517-9/16	20352888	3.6
TL1215-5/8	20352796	0.8	TL1615-5/8	20352839	1.3	TL2517-5/8	20352889	3.5
TL1215-11/16	20352797	0.8	TL1615-11/16	20352840	1.2	TL2517-11/16	20352890	3.4
TL1215-3/4	20352798	0.8	TL1615-3/4	20352841	1.2	TL2517-3/4	20352891	3.4
TL1215-13/16	20352799	0.8	TL1615-13/16	20352842	1.2	TL2517-13/16	20352892	3.3
TL1215-7/8	20352800	0.8	TL1615-7/8	20352843	1.1	TL2517-7/8	20352893	3.3
TL1215-15/16	20352801	0.8	TL1615-15/16	20352844	1.1	TL2517-15/16	20352894	3.3
TL1215-1	20352802	0.7	TL1615-1	20352845	1.1	TL2517-1	20352895	3.2
TL1215-1 1/16	20352803	0.6	TL1615-1 1/16	20352846	1	TL2517-1 1/18	20352897	3.2
TL1215-1 1/8	20352804	0.6	TL1615-1 1/8	20352847	1	TL2517-1 1/16	20352896	3.2
TL1215-1 3/16	20352805	0.5	TL1615-1 3/16	20352848	1	TL2517-1 1/4	20352899	3.2
TL1215-1 1/4	20352806	0.5	TL1615-1 1/4	20352849	0.9	TL2517-1 5/16	20352900	3.1

continued on page 126

Taper-Lock Bushings (continued)

Part #	SAP #	Weight	Part #	SAP #	Weight	Part #	SAP #	Weight
TL2517			TL3020			TL3535		
TL2517-1 3/8	20352901	3.1	TL3020-1 1/8	20352944	6.4	TL3535-2 3/4	20352989	10.4
TL2517-1 7/16	20352902	3	TL3020-1 3/16	20352945	6.4	TL3535-2 7/8	20352990	10.1
TL2517-1 1/2	20352903	2.9	TL3020-1 1/4	20352946	6.3	TL3535-2 15/16	20352991	9.8
TL2517-1 9/16	20352904	2.9	TL3020-1 5/16	20352947	6.1	TL3535-3	20352992	9.5
TL2517-1 5/8	20352905	2.8	TL3020-1 3/8	20352948	6	TL3535-3 1/8	20352993	9.3
TL2517-1 11/16	20352906	2.8	TL3020-1 7/16	20352949	6	TL3535-3 3/16	20352994	8.8
TL2517-1 3/4	20352907	2.7	TL3020-1 1/2	20352950	5.9	TL3535-3 1/4	20352995	8.7
TL2517-1 13/16	20352898	3.2	TL3020-1 9/16	20352951	5.9	TL3535-3 5/16	20352996	8.6
TL2517-1 7/8	20352909	2.5	TL3020-1 5/8	20352952	5.8	TL3535-3 3/8	20352997	8.5
TL2517-1 15/16	20352910	2.4	TL3020-1 11/16	20352953	5.7	TL3535-3 7/16	20352998	8.2
TL2517-2	20352911	2.3	TL3020-1 3/4	20352954	5.6	TL3535-3 1/2	20352999	7.9
TL2517-2 1/16	20352912	2.3	TL3020-1 13/16	20352955	5.5	TL3535-3 15/16	20582872	0.4
TL2517-2 1/8	20352913	2.2	TL3020-1 7/8	20352956	5.4	TL4040		
TL2517-2 3/16	20352914	2.1	TL3020-1 15/16	20352957	5.3	TL4040-1 7/16	20353000	22.1
TL2517-2 1/4	20352915	2	TL3020-2	20352958	5.2	TL4040-1 1/2	20353001	22
TL2517-2 5/16	20352916	1.9	TL3020-2 1/16	20352959	5	TL4040-1 5/8	20353002	21.8
TL2517-2 3/8	20352917	1.9	TL3020-2 1/8	20352960	5	TL4040-1 11/16	20353003	21.6
TL2517-2 7/16	20582870	0.4	TL3020-2 3/16	20352961	3.4	TL4040-1 3/4	20353004	21.3
TL2517-2 11/16	20582859	0.4	TL3020-2 1/4	20352962	4.8	TL4040-1 7/8	20353005	21
TL2517-2 15/16	20582876	0.4	TL3020-2 5/16	20352963	4.6	TL4040-1 15/16	20353006	20.9
TL2525			TL3020-2 3/8	20352964	4.5	TL4040-2	20353007	20.6
TL2525-3/4	20352918	4.7	TL3020-2 7/16	20352965	4.4	TL4040-2 1/8	20353008	20.5
TL2525-7/8	20352919	4.5	TL3020-2 1/2	20352966	4.3	TL4040-2 3/16	20353009	20.4
TL2525-1	20352920	4.4	TL3020-2 5/8	20352967	4	TL4040-2 1/4	20353010	20.1
TL2525-1 1/8	20352921	4.2	TL3020-2 11/16	20352968	3.9	TL4040-2 3/8	20353011	19.5
TL2525-1 3/16	20352922	4.2	TL3020-2 3/4	20352969	3.7	TL4040-2 7/16	20353012	19.3
TL2525-1 1/4	20352923	4.1	TL3020-2 13/16	20352970	3.7	TL4040-2 1/2	20353013	18.8
TL2525-1 3/8	20352924	3.9	TL3020-2 7/8	20352971	3.6	TL4040-2 5/8	20353014	18.5
TL2525-1 7/16	20352925	4	TL3020-2 15/16	20582871	0.4	TL4040-2 11/16	20353015	18.1
TL2525-1 1/2	20352926	3.8	TL3535			TL4040-2 3/4	20353016	17.7
TL2525-1 5/8	20352927	3.6	TL3535-1 3/16	20352972	14.8	TL4040-2 7/8	20353017	17.2
TL2525-1 11/16	20352928	3.5	TL3535-1 1/4	20352973	14.6	TL4040-2 15/16	20353018	17.1
TL2525-1 3/4	20352929	3.4	TL3535-1 3/8	20352974	14.2	TL4040-3	20353019	17
TL2525-1 13/16	20352930	3.2	TL3535-1 7/16	20352975	14.1	TL4040-3 1/8	20353020	16.5
TL2525-1 7/8	20352931	3.1	TL3535-1 1/2	20352976	14	TL4040-3 3/16	20353021	16.1
TL2525-1 15/16	20352932	3	TL3535-1 5/8	20352977	13.9	TL4040-3 1/4	20353022	15.4
TL2525-2	20352933	2.9	TL3535-1 11/16	20352978	13.5	TL4040-3 3/8	20353023	14.6
TL2525-2 1/18	20352934	2.6	TL3535-1 3/4	20352979	13.4	TL4040-3 7/16	20353024	14.1
TL2525-2 3/16	20352935	2.5	TL3535-1 7/8	20352980	13.2	TL4040-3 1/2	20353025	13.4
TL2525-2 1/4	20352936	2.4	TL3535-1 15/16	20352981	13	TL4040-3 5/8	20353026	13.3
TL2525-2 5/16	20352937	2.3	TL3535-2	20352982	12.8	TL4040-3 11/16	20353027	13.2
TL2525-2 3/8	20352938	2	TL3535-2 1/8	20352983	12.6	TL4040-3 3/4	20353028	12.8
TL2525-2 7/16	20352939	1.9	TL3535-2 3/16	20352984	12.4	TL4040-3 7/8	20353029	12.7
TL2525-2 1/2	20352940	1.7	TL3535-2 1/4	20352985	12.3	TL4040-3 15/16	20353030	12.6
TL3020			TL3535-2 7/16	20582873	0.4	TL4040-4	20353031	10.9
TL3020-7/8	20352941	6.5	TL3535-2 1/2	20352986	11.5			
TL3020-15/16	20352942	6.5	TL3535-2 5/8	20352987	11.1			
TL3020-1	20352943	6.5	TL3535-2 11/16	20352988	10.7			

continued on page 127

Bushing Hardware

Taper-Lock Bushings (continued)

Part #	SAP #	Weight	Part #	SAP #	Weight	Part #	SAP #	Weight
TL4545			TL4545			TL5050		
TL4545-1 15/16	20353032	30.3	TL4545-3 3/4	20353049	19	TL5050-3 7/8	20465709	29
TL4545-2	20353033	29.7	TL4545-3 7/8	20353050	18.9	TL5050-3 15/16	20465850	28.7
TL4545-2 3/16	20353034	29	TL4545-3 15/16	20353051	18.8	TL5050-4	20465851	27.8
TL4545-2 3/8	20353035	28.3	TL4545-4	20353052	18.7	TL5050-4 1/4	20465852	26
TL4545-2 7/16	20353036	28	TL4545-4 1/8	20353053	18.6	TL5050-4 3/8	20465853	25.8
TL4545-2 5/8	20353037	25.9	TL4545-4 3/16	20353054	18.5	TL5050-4 7/16	20465854	25.1
TL4545-2 3/4	20353038	25	TL4545-4 1/4	20353055	18.4	TL5050-4 1/2	20465855	23.6
TL4545-2 7/8	20353039	24.8	TL4545-4 3/8	20353056	16.8	TL5050-4 7/8	20465856	22.2
TL4545-2 15/16	20353040	24.1	TL4545-4 7/16	20353057	15.4	TL5050-5	20465858	20.2
TL4545-3	20353041	24	TL4545-4 1/2	20353058	15.1	TL5050-5 15/16	20465857	20.6
TL4545-3 1/8	20353042	23.9	TL5050			TL6050		
TL4545-3 3/16	20353043	23.8	TL5050-2 7/16	20465702	38.7	TL6050-4 7/16	20465859	57
TL4545-3 1/4	20353044	23.1	TL5050-2 11/16	20465703	37.1	TL6050-4 15/16	20465860	56
TL4545-3 3/8	20353045	22.4	TL5050-2 15/16	20465705	36.2	TL6050-5 7/16	20465861	52
TL4545-3 7/16	20353046	22.3	TL5050-3 3/8	20465706	32.7	TL6050-5 15/16	20465862	48
TL4545-3 1/2	20353047	21.1	TL5050-3 7/16	20465707	32	TL6050-6	20465863	45
TL4545-3 5/8	20353048	21	TL5050-3 5/8	20465708	31.1			

Sure-Grip® Bushings

Part #	SAP #	Weight	Part #	SAP #	Weight	Part #	SAP #	Weight
QT								
QT-7/16 MPB	20181485	0.6	QT-13/16	20181481	0.6	QT-1 3/16	20181475	0.6
QT-1/2	20181479	0.6	QT-7/8	20181486	0.6	QT-1 1/4	20181473	0.6
QT-9/16	20181487	0.6	QT-15/16	20181482	0.6	QT-1 5/16	20181477	0.6
QT-5/8	20181484	0.6	QT-1	20181470	0.6	QT-1 3/8	20181476	0.6
QT-11/16	20181480	0.6	QT-1 1/16	20181471	0.6	QT-1 7/16	20181478	0.6
QT-3/4	20181483	0.6	QT-1 1/8	20181474	0.6	QT-1 1/2	20181472	0.6
JA								
JA-1/2	20181291	0.8	JA-13/16	20181294	0.8	JA-1 1/8	20181289	0.8
JA-9/16	20181299	0.8	JA-7/8	20181298	0.8	JA-1 3/16	20181290	0.8
JA-5/8	20181297	0.8	JA-15/16	20181295	0.8	JA-1 1/4	20181288	0.8
JA-11/16	20181293	0.8	JA-1	20181286	0.8			
JA-3/4	20181296	0.8	JA-1 1/16	20181287	0.8			
SH								
SH-7/16 MPB	20181730	1.1	SH-7/8	20181731	1.0	SH-1 5/16	20181720	0.7
SH-1/2	20181724	1.1	SH-15/16	20181727	1.0	SH-1 3/8	20181719	0.7
SH-9/16	20181732	1.1	SH-1	20181712	0.9	SH-1 7/16	20181722	0.7
SH-5/8	20181729	1.1	SH-1 1/16	20181713	0.9	SH-1 1/2	20181714	0.6
SH-11/16	20181725	1.0	SH-1 1/8	20181716	0.9	SH-1 9/16	20181723	0.6
SH-3/4	20181728	1.0	SH-1 3/16	20181718	0.8	SH-1 5/8	20181721	0.5
SH-13/16	20181726	1.0	SH-1 1/4	20181715	0.8	SH-1 11/16	20181717	0.5

*Trademark of TB Wood's Incorporated.

continued on page 128

Part #	SAP #	Weight	Part #	SAP #	Weight	Part #	SAP #	Weight
SDS								
SDS-7/16 MPB	20181583	1.7	SDS-1 1/16	20181560	1.4	5V8.5-4-E	20180890	21.5
SDS-1/2	20181576	1.7	SDS-1 1/8	20181563	1.4	SDS-1 5/8	20181572	1.0
SDS-9/16	20181585	1.7	SDS-1 3/16	20181567	1.4	SDS-1 11/16	20181564	1.0
SDS-5/8	20181582	1.6	SDS-1 1/4	20181562	1.3	SDS-1 3/4	20181568	1.0
SDS-11/16	20181577	1.6	SDS-1 5/16	20181571	1.3	SDS-1 13/16	20181565	0.9
SDS-3/4	20181581	1.6	SDS-1 3/8	20181569	1.2	SDS-1 7/8	20181574	0.9
SDS-13/16	20181578	1.6	SDS-1 3/8 3/8 KS	20181570	1.2	SDS-1 15/16	20181566	0.8
SDS-7/8	20181584	1.5	SDS-1 7/16	20181573	1.2	SDS-2	20181580	0.7
SDS-15/16	20181579	1.5	SDS-1 1/2	20181561	1.1			
SDS-1	20181559	1.5	SDS-1 9/16	20181575	1.1			
SD								
SD-7/16 MPB	20181543	2.1	SD-1	20181519	1.8	SD-1 1/2	20181521	1.4
SD-1/2	20181536	2.1	SD-1 1/16	20181520	1.8	SD-1 9/16	20181535	1.3
SD-9/16	20181545	2.1	SD-1 1/8	20181523	1.7	SD-1 5/8	20181532	1.2
SD-5/8	20181542	2.1	SD-1 3/16	20181527	1.7	SD-1 11/16	20181524	1.2
SD-11/16	20181537	2.0	SD-1 1/4	20181522	1.6	SD-1 3/4	20181528	1.1
SD-3/4	20181541	2.0	SD-1 5/16	20181531	1.6	SD-1 13/16	20181525	1.1
SD-13/16	20181538	2.0	SD-1 3/8	20181529	1.5	SD-1 7/8	20181534	1.0
SD-7/8	20181544	1.9	SD-1 3/8 3/8 KS	20181530	1.5	SD-1 15/16	20181526	0.9
SD-15/16	20181539	1.9	SD-1 7/16	20181533	1.4	SD-2	20181540	0.8
SK								
SK-7/16 MPB	20181790	3.6	SK-1 5/16	20181766	3.1	SK-2	20181776	2.2
SK-1/2	20181772	3.6	SK-1 5/16 3/8 KS	20181767	3.1	SK-2 1/16	20181777	2.1
SK-9/16	20181792	3.6	SK-1 3/8	20181764	3.0	SK-2 1/8	20181781	2.0
SK-5/8	20181789	3.6	SK-1 3/8 3/8 KS	20181765	3.0	SK-2 3/16	20181782	2.0
SK-11/16	20181773	3.5	SK-1 7/16	20181769	2.9	SK-2 1/4	20181779	1.9
SK-3/4	20181788	3.5	SK-1 1/2	20181755	2.9	SK-2 1/4 5/8 KW	20181780	1.9
SK-13/16	20181774	3.5	SK-1 9/16	20181771	2.8	SK-2 5/16	20181784	1.8
SK-7/8	20181791	3.4	SK-1 5/8	20181768	2.7	SK-2 3/8	20181783	1.7
SK-15/16	20181775	3.4	SK-1 11/16	20181758	2.6	SK-2 7/16	20181786	1.6
SK-1	20181753	3.3	SK-1 3/4	20181762	2.5	SK-2 1/2	20181778	1.5
SK-1 1/16	20181754	3.3	SK-1 3/4 1/2 KS	20181763	2.5	SK-2 9/16 NO KW	20181787	1.3
SK-1 1/8	20181757	3.2	SK-1 13/16	20181759	2.4	SK-2 5/8 NO KW	20181785	1.1
SK-1 3/16	20181761	3.2	SK-1 7/8	20181770	2.4			
SK-1 1/4	20181756	3.1	SK-1 15/16	20181760	2.3			
SF								
SF-1/2 MPB	20181636	5.1	SF-1 3/8 3/8 KS	20181629	4.4	SF-2 3/16 DI	20181646	3.2
SF-1/2	20181635	5.1	SF-1 7/16	20181632	4.3	SF-2 1/4 DI	20181642	3.1
SF-5/8	20181655	5.0	SF-1 1/2	20181620	4.2	SF-2 1/4 5/8 KS D	20181641	3.1
SF-3/4	20181654	5.0	SF-1 9/16	20181634	4.2	SF-2 5/16 DI	20181649	3.1
SF-7/8	20181656	4.9	SF-1 5/8	20181631	4.1	SF-2 3/8 DI	20181648	3.0
SF-15/16	20181637	4.8	SF-1 11/16	20181623	4.0	SF-2 7/16 DI	20181651	2.9
SF-1	20181618	4.8	SF-1 3/4	20181627	3.9	SF-2 1/2 DI	20181640	2.8
SF-1 1/16	20181619	4.7	SF-1 13/16	20181624	3.8	SF-2 9/16 DI	20181653	2.6
SF-1 1/8	20181622	4.7	SF-1 7/8	20181633	3.7	SF-2 5/8 DI	20181650	2.5
SF-1 3/16	20181626	4.6	SF-1 5/16	20181630	3.6	SF-2 11/16 DI	20181644	2.4
SF-1 1/4	20181621	4.5	SF-2	20181638	3.5	SF-2 3/4 DI	20181647	2.2
SF-1 5/16	20181630	4.5	SF-2 1/16	20181639	3.4	SF-2 7/8 DI	20181652	1.8
SF-1 3/8	20181628	4.4	SF-2 1/8	20181643	3.3	SF-2 15/16 DI	20181645	1.7

*Trademark of TB Wood's Incorporated.

continued on page 129

Bushing Hardware

Sure-Grip®* Bushings (continued)

Part #	SAP #	Weight	Part #	SAP #	Weight	Part #	SAP #	Weight
E								
E-7/8PB	20181089	10.8	E-1 3/4	20181054	9.6	E-2 5/8	20181076	7.5
E-7/8	20181088	10.8	E-1 13/16	20181051	9.4	E-2 11/16 DI	20181069	7.3
E-15/16	20181062	10.8	E-1 7/8	20181060	9.3	E-2 3/4 DI	20181073	7.1
E-1	20181046	10.7	E-1 15/16	20181052	9.2	E-2 13/16 DI	20181070	7.2
E-1 1/8	20181049	10.6	E-2	20181063	9.0	E-2 7/8 DI	20181078	7.1
E-1 3/16	20181053	10.5	E-2 1/16	20181064	8.9	E-2 15/16 DI	20181071	6.9
E-1 1/4	20181048	10.4	E-2 1/8	20181068	8.8	E-3 DI	20181087	6.7
E-1 5/16	20181057	10.3	E-2 3/16	20181072	8.6	E-3 1/8 DI	20181082	6.3
E-1 3/8	20181055	10.2	E-2 1/4	20181066	8.5	E-3 3/16 DI	20181083	6.0
E-1 3/8 3/8 KS	20181056	10.2	E-2 1/4 5/8 KS	20181067	8.5	E-3 1/4 DI	20181081	5.8
E-1 7/16	20181059	10.1	E-2 5/16	20181075	8.3	E-3 5/16 DI	20181085	5.7
E-1 1/2	20181047	10.0	E-2 3/8	20181074	8.1	E-3 3/8 DI	20181084	5.5
E-1 9/16	20181061	9.9	E-2 7/16	20181077	8.0	E-3 7/16 DI	20181086	5.2
E-1 5/8	20181058	9.8	E-2 1/2	20181065	7.8	E-3 1/2 DI	20181080	4.7
E-1 11/16	20181050	9.7	E-2 9/16	20181079	7.6			
F								
F-1	20181147	17.9	F-2 1/8	20181166	15.2	F-3	20181178	11.8
F-1 1/8	20181150	17.7	F-2 3/16	20181170	15.0	F-3 1/8	20181181	11.2
F-1 3/16	20181153	17.6	F-2 1/4	20181164	14.8	F-3 3/16 DI	20181184	10.9
F-1 1/4	20181149	17.5	F-2 1/4 5/8 KS	20181165	14.8	F-3 1/4 DI	20181180	10.6
F-1 3/8	20181155	17.2	F-2 5/16	20181173	14.5	F-3 5/16 DI	20181187	11.0
F-1 7/16	20181157	17.1	F-2 3/8	20181172	14.3	F-3 3/8 DI	20181186	10.6
F-1 1/2	20181148	16.9	F-2 7/16	20181175	14.1	F-3 7/16 DI	20181189	10.3
F-1 9/16	20181159	16.8	F-2 1/2	20181163	13.9	F-3 1/2 DI	20181179	10.0
F-1 5/8	20181156	16.7	F-2 9/16	20181177	13.7	F-3 5/8 DI	20181188	9.4
F-1 11/16	20181151	16.5	F-2 5/8	20181174	13.4	F-3 11/16 DI	20181182	9.0
F-1 3/4	20181154	16.3	F-2 11/16	20181167	13.2	F-3 3/4 DI	20181185	8.7
F-1 7/8	20181158	16.0	F-2 3/4	20181171	12.9	F-3 7/8 DI	20181190	8.1
F-1 15/16	20181152	15.8	F-2 13/16	20181168	12.6	F-3 15/16 DI	20181183	7.7
F-2	20181161	15.6	F-2 7/8	20181176	12.3	F-4 NO KW DI	20181191	6.9
F-2 1/16	20181162	15.4	F-2 15/16	20181169	12.1			
TL								
J-1 7/16 MPB	20181250	28.1	J-2 7/16	20181263	24.5	J-3 1/2	20181266	18.5
J-1 7/16	20181249	28.1	J-2 1/2	20181253	24.2	J-3 5/8	20181276	17.7
J-1 1/2	20181245	28.0	J-2 5/8	20181262	23.6	J-3 11/16 DI	20181269	17.2
J-1 11/16	20181246	27.4	J-2 11/16	20181256	23.3	J-3 3/4 DI	20181273	16.8
J-1 3/4	20181248	27.2	J-2 3/4	20181259	23.0	J-3 13/16 DI	20181270	17.4
J-1 7/8	20181251	26.7	J-2 7/8	20181264	22.2	J-3 7/8 DI	20181278	17.0
J-1 15/16	20181247	26.5	J-2 15/16	20181257	21.9	J-3 15/16 DI	20181271	16.5
J-2	20181252	26.3	J-3	20181265	21.6	J-4 DI	20181285	16.1
J-2 1/8	20181255	25.8	J-3 1/8	20181268	20.9	J-4 1/8 DI	20181281	15.2
J-2 3/16	20181258	25.6	J-3 3/16	20181272	20.5	J-4 3/16 DI	20181282	14.7
J-2 1/4	20181254	25.3	J-3 1/4	20181267	20.1	J-4 1/4 DI	20181280	14.2
J-2 1/4-5/8KS	20332967	25.3	J-3 5/16	20181275	19.6	J-4 3/8 DI	20181283	13.2
J-2 5/16	20181261	25.0	J-3 3/8	20181274	19.3	J-4 7/16 DI	20181284	12.7
J-2 3/8	20181260	24.7	J-3 7/16	20181277	18.9	J-4 1/2 DI	20181279	12.2

*Trademark of TB Wood's Incorporated.

continued on page 130

Part #	SAP #	Weight	Part #	SAP #	Weight	Part #	SAP #	Weight
M								
M-1 15/16 MPB	20181336	63.7	M-3 3/16	20181356	54.6	M-4 3/8	20181370	41.9
M-1 15/16	20181335	63.7	M-3 1/4	20181351	54.1	M-4 7/16	20181372	41.2
M-2	20181337	63.3	M-3 3/8	20181358	52.8	M-4 1/2	20181363	40.4
M-2 3/16	20181342	62.3	M-3 7/16	20181360	52.2	M-4 5/8	20181371	38.5
M-2 1/4	20181339	61.9	M-3 1/2	20181350	51.6	M-4 11/16	20181366	37.5
M-2 3/8	20181344	61.0	M-3 5/8	20181359	50.4	M-4 3/4	20181369	36.7
M-2 7/16	20181347	60.6	M-3 11/16	20181353	49.7	M-4 7/8	20181373	37.8
M-2 1/2	20181338	60.1	M-3 3/4	20181357	49.1	M-4 15/16	20181367	37.0
M-2 5/8	20181346	59.3	M-3 13/16	20181354	48.4	M-5	20181374	36.1
M-2 11/16	20181340	58.8	M-3 7/8	20181361	47.6	M-5 3/16	20181377	33.5
M-2 3/4	20181343	58.3	M-3 15/16	20181355	46.9	M-5 1/4	20181376	32.6
M-2 7/8	20181348	57.2	M-4	20181362	46.2	M-5 3/8	20181378	31.0
M-2 15/16	20181341	56.7	M-4 1/8	20181365	44.8	M-5 7/16	20181379	29.9
M-3	20181349	56.2	M-4 3/16	20181368	44.1	M-5 1/2	20181375	28.9
M-3 1/8	20181352	55.2	M-4 1/4	20181364	43.4			
N								
N-2 15/16	20181393	84.1	N-4	20181402	71.5	N-4 15/16	20181405	57.0
N-3	20181394	83.5	N-4 3/16	20181406	68.9	N-5	20181412	56.0
N-3 3/8	20181398	79.3	N-4 1/4	20181404	68.1	N-5 3/16	20181415	56.1
N-3 7/16	20181400	78.6	N-4 3/8	20181408	66.3	N-5 7/16	20181416	51.7
N-3 1/2	20181395	77.9	N-4 7/16	20181410	65.4	N-5 1/2	20181413	50.6
N-3 5/8	20181399	76.4	N-4 1/2	20181403	64.5	N-5 7/8	20181417	44.3
N-3 3/4	20181397	74.9	N-4 5/8	20181409	62.0	N-5 15/16	20181414	43.9
N-3 7/8	20181401	73.1	N-4 3/4	20181407	60.0			
N-3 15/16	20181396	72.3	N-4 7/8	20181411	58.1			
P								
P-2 15/16	20181425	141.2	P-4 1/2	20181434	118.6	P-5 1/2	20181444	98.8
P-3 1/4	20181427	137.6	P-4 5/8	20181440	115.7	P-5 3/4	20181448	98.1
P-3 7/16	20181431	134.9	P-4 11/16	20181436	114.6	P-5 7/8	20181452	95.3
P-3 1/2	20181426	134.1	P-4 3/4	20181438	113.5	P-5 15/16	20181446	93.9
P-3 5/8	20181430	132.4	P-4 7/8	20181442	111.2	P-6	20181453	92.5
P-3 3/4	20181429	130.6	P-4 15/16	20181437	110.0	P-6 1/16	20181454	91.0
P-3 7/8	20181432	128.5	P-5	20181443	108.8	P-6 1/4	20181456	86.5
P-3 15/16	20181428	127.6	P-5 3/16	20181447	105.2	P-6 7/16	20181458	82.0
P-4	20181433	126.7	P-5 1/4	20181445	103.9	P-6 1/2	20181455	80.5
P-4 1/4	20181435	122.7	P-5 5/16	20181450	102.7	P-6 3/4	20181457	74.7
P-4 3/8	20181439	120.7	P-5 3/8	20181449	101.4	P-7	20181459	68.1
P-4 7/16	20181441	119.6	P-5 7/16	20181451	100.1			
W								
W-4 1/4 MPB	20181843	249.0	W-5 1/4 MPB	20181845	227.0	W-6 1/2 MPB	20181847	193.0
W-4 7/8 MPB	20181844	235.0	W-5 7/8 MPB	20181846	210.0	W-7 1/4 MPB	20181848	169.0
S								
S-6 MPB	20181516	471.0	S-8 MPB	20181517	381.0	S-9 MPB	20181518	326.0

*Trademark of TB Wood's Incorporated.

Bushing Hardware

Sure-Grip® Bushings - Millimeter Bores-in. Bolts

Part #	SAP #	Weight	Part #	SAP #	Weight	Part #	SAP #	Weight
QTX								
QTX14MM	20181502	0.6	QTX20MM	20181507	0.6	QTX30MM	20181512	0.6
QTX15MM	20181503	0.6	QTX22MM	20181508	0.6	QTX32MM	20181513	0.6
QTX16MM	20181504	0.6	QTX24MM	20181509	0.6	QTX35MM	20181514	0.6
QTX18MM	20181505	0.6	QTX25MM	20181510	0.6	QTX38MM	20181515	0.6
QTX19MM	20181506	0.6	QTX28MM	20181511	0.6			
JAX								
JAX15MM	20181310	0.8	JAX20MM	20181313	0.8	JAX28MM	20181316	0.8
JAX16MM	20181311	0.8	JAX24MM	20181314	0.8			
JAX19MM	20181312	0.8	JAX25MM	20181315	0.8			
SHX								
SHX24MM	20181747	0.9	SHX28MM	20181749	0.9	SHX32MM	20181751	0.8
SHX25MM	20181748	0.9	SHX30MM	20181750	0.8	SHX35MM	20181752	0.7
SDSX								
SDSX24MM	20181600	1.5	SDSX30MM	20181603	1.4	SDSX38MM	20181606	1.1
SDSX25MM	20181601	1.5	SDSX32MM	20181604	1.3	SDSX40MM	20181607	1.1
SDSX28MM	20181602	1.4	SDSX35MM	20181605	1.2	SDSX42MM	20181608	1.0
SDX								
SDX24MM	20181609	1.8	SDX30MM	20181612	1.7	SDX38MM	20181615	1.4
SDX25MM	20181610	1.8	SDX32MM	20181613	1.6	SDX40MM	20181616	1.3
SDX28MM	20181611	1.7	SDX35MM	20181614	1.5	SDX42MM	20181617	1.2
SKX								
SKX24MM	20181830	3.3	SKX35MM	20181835	3.0	SKX48MM	20181840	2.4
SKX25MM	20181831	3.3	SKX38MM	20181836	2.9	SKX50MM	20181841	2.3
SKX28MM	20181832	3.2	SKX40MM	20181837	3.6	SKX55MM	20181842	2.0
SKX30MM	20181833	3.2	SKX42MM	20181838	2.7			
SKX32MM	20181834	3.1	SKX45MM	20181839	2.6			
SFX								
SFX28MM	20181699	4.7	SFX40MM	20181704	4.2	SFX55MM	20181709	3.2
SFX30MM	20181700	4.6	SFX42MM	20181705	4.1	SFX60MM DI	20181710	3.0
SFX32MM	20181701	4.5	SFX45MM	20181706	3.9	SFX65MM DI	20181711	2.8
SFX35MM	20181702	4.4	SFX48MM	20181707	3.7			
SFX38MM	20181703	4.2	SFX50MM	20181708	3.6			
EX								
EX35MM	20181134	10.2	EX48MM	20181139	9.3	EX70MM	20181144	7.1
EX38MM	20181135	10.0	EX50MM	20181140	9.2	EX75MM DI	20181145	6.9
EX40MM	20181136	9.9	EX55MM	20181141	8.6	EX80MM DI	20181146	6.7
EX42MM	20181137	9.8	EX60MM	20181142	8.1			
EX45MM	20181138	9.6	EX65MM	20181143	7.6			

*Trademark of TB Wood's Incorporated.

continued on page 132

Sure-Grip® Bushings - Millimeter Bores-in. Bolts (continued)

Part #	SAP #	Weight	Part #	SAP #	Weight	Part #	SAP #	Weight
FX								
FX45MM	20181234	16.2	FX60MM	20181238	14.3	FX80MM	20181242	11.2
FX48MM	20181235	16.0	FX65MM	20181239	13.7	FX85MM	20181243	10.6
FX50MM	20181236	15.8	FX70MM	20181240	12.9	FX90MM DI	20181244	9.7
FX55MM	20181237	15.0	FX75MM	20181241	12.1			
JX								
JX50MM	20181325	26.5	JX70MM	20181329	23.0	JX90MM	20181333	18.1
JX55MM	20181326	25.6	JX75MM	20181330	21.9	JX95MM	20181334	16.8
JX60MM	20181327	24.7	JX80MM	20181331	20.9	JX100MM	20181324	16.5
JX65MM	20181328	23.9	JX85MM	20181332	19.3			
MX								
MX80MM	20181389	55.0	MX100MM	20181387	46.9	MX120MM	20181388	37.0
MX90MM	20181390	51.2						
N								
N-100MM	20181391	72.3	N-120MM	20181392	60.2			
PX								
PX150MM	20181469	95.8						

*Trademark of TB Wood's Incorporated.

“L” Series Flangeless Bushings

Part #	SAP #	Weight	Part #	SAP #	Weight	Part #	SAP #	Weight
SKL								
SKL-1/2	20181808	1.7	SKL-1 3/16	20181800	1.4	SKL-1 5/8	20181804	1.1
SKL-5/8	20181812	1.7	SKL-1 1/4	20181795	1.4	SKL-1 11/16	20181797	1.1
SKL-3/4	20181811	1.6	SKL-1 5/16	20181803	1.3	SKL-1 3/4	20181801	1.0
SKL-7/8	20181813	1.6	SKL-1 3/8	20181802	1.3	SKL-1 13/16	20181798	1.0
SKL-15/16	20181810	1.6	SKL-1 7/16	20181805	1.2	SKL-1 7/8	20181806	0.9
SKL-1	20181793	1.6	SKL-1 1/2	20181794	1.2	SKL-1 15/16	20181799	0.8
SKL-1 1/8	20181796	1.5	SKL-1 9/16	20181807	1.2			
SFL								
SFL-1/2	20181673	2.1	SFL-1 5/16	20181668	1.7	SFL-1 7/8	20181671	1.3
SFL-5/8	20181683	2.1	SFL-1 3/8	20181667	1.7	SFL-1 15/16	20181664	1.3
SFL-3/4	20181682	2.0	SFL-1 7/16	20181670	1.6	SFL-2	20181676	1.2
SFL-7/8	20181684	2.0	SFL-1 1/2	20181659	1.6	SFL-2 1/8	20181678	1.1
SFL-15/16	20181675	2.0	SFL-1 9/16	20181672	1.5	SFL-2 3/16	20181679	1.0
SFL-1	20181658	2.0	SFL-1 5/8	20181669	1.5	SFL-2 1/4	20181677	1.0
SFL-1 1/8	20181661	1.9	SFL-1 11/16	20181662	1.4	SFL-2 5/16	20181681	0.9
SFL-1 3/16	20181665	1.8	SFL-1 3/4	20181666	1.4	SFL-2 3/8	20181680	0.9
SFL-1 1/4	20181660	1.8	SFL-1 13/16	20181663	1.4			

continued on page 133

Bushing Hardware

"L" Series Flangeless Bushings (continued)

Part #	SAP #	Weight	Part #	SAP #	Weight*	Part #	SAP #	Weight
EL								
EL-78 MPB	20181121	4.1	EL-1 9/16	20181104	3.4	EL-2 5/16	20181115	2.6
EL-78	20181120	4.1	EL-1 5/8	20181101	3.4	EL-2 3/8	20181114	2.5
EL-15/16	20181105	4.0	EL-1 11/16	20181094	3.3	EL-2 7/16	20181117	2.4
EL-1	20181090	3.9	EL-1 3/4	20181098	3.2	EL-2 1/2	20181107	2.3
EL-1 1/8	20181093	3.8	EL-1 13/16	20181095	3.2	EL-2 9/16	20181119	2.3
EL-1 3/16	20181097	3.8	EL-1 7/8	20181103	3.1	EL-2 5/8	20181116	2.2
EL-1 1/4	20181092	3.7	EL-1 15/16	20181096	3.0	EL-2 11/16	20181110	2.1
EL-1 5/16	20181100	3.6	EL-2	20181106	3.0	EL-2 3/4	20181113	2.0
EL-1 3/8	20181099	3.6	EL-2 1/8	20181109	2.9	EL-2 13/16	20181111	1.9
EL-1 7/16	20181102	3.5	EL-2 3/16	20181112	2.8	EL-2 7/8	20181118	1.8
EL-1 1/2	20181091	3.5	EL-2 1/4	20181108	2.7			

FL								
FL-1	20181192	8.5	FL-1 3/4	20181199	7.3	FL-2 1/2	20181207	5.9
FL-1 1/8	20181195	8.3	FL-1 7/8	20181203	7.1	FL-2 9/16	20181220	5.7
FL-1 3/16	20181198	8.2	FL-1 15/16	20181197	7.0	FL-2 5/8	20181217	5.6
FL-1 1/4	20181194	8.1	FL-2	20181206	6.7	FL-2 11/16	20181210	5.4
FL-1 3/8	20181200	8.0	FL-2 1/8	20181209	6.6	FL-2 3/4	20181214	5.3
FL-1 7/16	20181202	7.9	FL-2 3/16	20181213	6.5	FL-2 13/16	20181211	5.1
FL-1 1/2	20181193	7.8	FL-2 1/4	20181208	6.4	FL-2 7/8	20181219	4.9
FL-1 9/16	20181204	7.6	FL-2 5/16	20181216	6.3	FL-2 15/16	20181212	4.8
FL-1 5/8	20181201	7.5	FL-2 3/8	20181215	6.2	FL-3	20181221	4.6
FL-1 11/16	20181196	7.4	FL-2 7/16	20181218	6.1	FL-3 1/8	20181222	4.5

Sure-Grip® Idler Bushings

Part #	SAP #	Weight	Use Bearing #
MISC.			
SH-BB	20221732	1.5	Use bearing G275
SD-BB	20221733	2.5	Use bearing G275
SK-BB	20221734	4.5	Use bearing G276
SF-BB	20221735	8.0	Use bearing G276
E-BB	20221736	12.0	Use bearing G277

Sure-Grip® Replacement Berrings

Part #	SAP #	Weight
MISC.		
G275	20221737	1.0
G276	20221738	1.0
G277	20221739	0.8

*Trademark of TB Wood's Incorporated.

*Trademark of TB Wood's Incorporated.

Metric Sure-Grip®* Bushings

Part #	SAP #	Weight	Part #	SAP #	Weight*	Part #	SAP #	Weight
QTMX								
QTMX10MM	20181489	0.6	QTMX16MM	20181494	0.6	QTMX28MM	20181498	0.6
QTMX10MM	20181489	0.6	QTMX19MM	20181488	0.6	QTMX30MM	20181499	0.6
QTMX11MM	20181491	0.6	QTMX20MM	20181495	0.6	QTMX32MM	20181500	0.6
QTMX14MM	20181492	0.6	QTMX24MM	20181496	0.6	QTMX38MM	20181501	0.6
QTMX15MM	20181493	0.6	QTMX25MM	20181497	0.6			
JAMX								
JAMX10MM	20181300	0.8	JAMX15MM	20181304	0.8	JAMX24MM	20181307	0.8
JAMX11MM	20181302	0.8	JAMX19MM	20181305	0.8	JAMX25MM	20181308	0.8
JAMX14MM	20181303	0.8	JAMX20MM	20181306	0.8	JAMX28MM	20181309	0.8
SHMX								
SHMX10MM	20181733	1.1	SHMX15MM	20181737	1.1	SHMX24MM	20181740	1.0
SHMX11MM	20181735	1.1	SHMX19MM	20181738	1.0	SHMX25MM	20181741	1.0
SHMX14MM	20181736	1.1	SHMX20MM	20181739	1.0	SHMX28MM	20181742	0.9
SHMX15MM	20181737	1.1	SHMX24MM	20181740	1.0	SHMX30MM	20181743	0.8
SHMX19MM	20181738	1.0	SHMX25MM	20181741	1.0	SHMX35MM	20181744	0.8
SHMX10MM	20181733	1.1	SHMX28MM	20181742	0.9	SHMX38MM	20181745	0.7
SHMX11MM	20181735	1.1	SHMX30MM	20181743	0.8	SHMX40MM	20181746	0.6
SHMX14MM	20181736	1.1	SHMX20MM	20181739	1.0			
SDSMX								
SDSMX10MM MPB	20181586	1.7	SDSMX25MM	20181591	1.5	SDSMX38MM	20181596	1.1
SDSMX15MM	20181587	1.6	SDSMX28MM	20181592	1.4	SDSMX40MM	20181597	1.0
SDSMX19MM	20181588	1.6	SDSMX30MM	20181593	1.4	SDSMX42MM	20181598	1.0
SDSMX20MM	20181589	1.6	SDSMX32MM	20181594	1.3	SDSMX48MM	20181599	0.9
SDSMX24MM	20181590	1.5	SDSMX35MM	20181595	1.2			
SDMX								
SDMX15MM	20181546	2.0	SDMX28MM	20181552	1.7	SDMX40MM	20181556	1.3
SDMX19MM	20181548	1.9	SDMX30MM	20181553	1.7	SDMX42MM	20181557	1.2
SDMX20MM	20181549	1.9	SDMX35MM	20181554	1.5	SDMX48MM	20181558	1.0
SDMX24MM	20181550	1.9	SDMX38MM	20181555	1.4			
SKMX								
SKMX15MM MPB	20181815	3.6	SKMX30MM	20181820	3.2	SKMX42MM	20181825	2.7
SKMX19MM	20181816	3.5	SKMX32MM	20181821	3.1	SKMX48MM	20181826	2.4
SKMX20MM	20181817	3.5	SKMX35MM	20181822	3.0	SKMX50MM	20181827	2.3
SKMX24MM	20181818	3.4	SKMX38MM	20181823	2.9	SKMX55MM	20181828	2.0
SKMX28MM	20181819	3.2	SKMX40MM	20181824	2.8	SKMX60MM	20181829	1.7
SFMX								
SFMX15MM MPB	20181686	5.1	SFMX35MM	20181691	4.0	SFMX50MM	20181696	3.5
SFMX20MM	20181687	5.0	SFMX38MM	20181692	4.2	SFMX55MM	20181697	3.2
SFMX24MM	20181688	4.8	SFMX40MM	20181693	4.2	SFMX60MM	20181698	3.0
SFMX28MM	20181689	4.7	SFMX42MM	20181694	4.1			
SFMX30MM	20181690	4.6	SFMX48MM	20181695	3.7			

*Trademark of TB Wood's Incorporated.

continued on page 135

Bushing Hardware

Metric Sure-Grip®** Bushings (continued)

Part #	SAP #	Weight*	Part #	SAP #	Weight*	Part #	SAP #	Weight*
EMX								
EMX20MM MPB	20181123	10.8	EMX40MM	20181127	9.9	EMX55MM	20181131	8.6
EMX28MM	20181124	10.6	EMX42MM	20181128	9.8	EMX60MM	20181132	8.1
EMX30MM	20181125	10.5	EMX48MM	20181129	9.3	EMX70MM	20181133	7.1
EMX38MM	20181126	10.0	EMX50MM	20181130	9.2			
FMX								
FMX20MM MPB	20181224	18.0	FMX42MM MPB	20181228	16.7	FMX60MM MPB	20181232	14.3
FMX30MM MPB	20181225	17.6	FMX48MM MPB	20181229	18.0	FMX70MM MPB	20181233	12.9
FMX38MM MPB	20181226	16.9	FMX50MM MPB	20181230	15.7			
FMX40MM MPB	20181227	16.8	FMX55MM MPB	20181231	15.0			

*Trademark of TB Wood's Incorporated.

Metric "L" Series Flangeless Bushings

Part #	SAP #	Weight	Part #	SAP #	Weight	Part #	SAP #	Weight
SKLMX								
SKLMX15MM MPB	20181814	1.7	SFLMX15MM MPB	20181685	2.1	ELMX20MM MPB	20181122	4.1

Sure-Grip®** Short Bushings

Part #	SAP #	Weight	Part #	SAP #	Weight	Part #	SAP #	Weight
JS								
JS-2 7/16	20181318	20.0	JS-3 7/16	20181322	15.9	JS-3 15/16	20181321	14.3
JS-2 15/16	20181317	18.1	JS-3 1/2	20181320	15.6	JS-4 7/16	20181323	11.5
MS								
MS-3 7/16	20181382	41.2	MS-4 7/16	20181385	33.3	MS-5 1/2	20332977	25.9
MS-3 1/2	20181380	40.7	MS-4 15/16	20181384	30.9			
MS-3 15/16	20181381	37.3	MS-5 7/16	20181386	25.9			
NS								
NS-3 15/16	20181419	66.3	NS-5 7/16	20181423	43.9	NS-6	20181424	38.8
NS-4 7/16	20181421	52.5	NS-5 1/2	20332968	43.1			
NS-4 15/16	20181420	46.5	NS-5 15/16	20181422	39.0			
PS								
PS-4 15/16	20181460	88.3	PS-6	20181464	77.4	PS-6 15/16	20181466	61.3
PS-5 7/16	20181463	81.3	PS-6 7/16	20181467	70.0	PS-7	20181468	60.4
PS-5 15/16	20181462	78.4	PS-6 1/2	20181465	69.0			
WS								
WS-5 7/16	20181850	172.3	WS-6 1/2	20181852	153.0	WS-7 15/16	20181857	126.9
WS-5 15/16	20181849	161.1	WS-6 15/16	20181853	140.0	WS-8	20181858	124.0
WS-6	20181851	160.0	WS-7	20181855	139.0	WS-8 7/16	20181860	107.3
WS-6 7/16	20181854	155.0	WS-7 1/2	20181856	137.0	WS-8 1/2	20181859	105.0

*Trademark of TB Wood's Incorporated.

Flat Idlers

Part #	SAP #	Weight	Part #	SAP #	Weight	Part #	SAP #	Weight
2.0-SH								
6.0X2.0-SH-62S	20466995	4.6	10.0X2.0-SH-102S	20468346	7.5	12.0X2.0-SH-122S	20468381	11.1
7.0X2.0-SH-72S	20468276	5.1	9.0X2.0-SH-92S	20468358	6.3			
8.0X2.0-SH-82S	20468295	5.7	11.0X2.0-SH-112S	20468380	9			
2.0-SDS								
14.0X2.0-SDS-142S	20468382	14	16.0X2.0-SDS-162S	20468383	16.6			
2.75-SD								
4.0X2.75-SD-4234S	20468384	5.1	7.0X2.75-SD-7234S	20468387	7.3	10.0X2.75-SD-10234	20468390	12.1
5.0X2.75-SD-5234S	20468385	7.7	8.0X2.75-SD-8234S	20468388	8.4	11.0X2.75-SD-11234	20468391	14
6.0X2.75-SD-6234S	20468386	7.9	9.0X2.75-SD-9234S	20468389	8.9	12X2.75-SD-12234S	20468392	16.5
2.75-SF								
14.0X2.75-SF-14234	20468393	22.5	18.0X2.75-SF-18234	20468395	28.2			
16X2.75-SF-16234S	20468394	25.3	20.0X2.75-SF-20234	20468396	35.5			
3.25-SD								
4.0X3.25-SD-4314S	20468397	5.4	7.0X3.25-SD-7314S	20468400	7.9	11.0X3.25-SD-11314	20468404	13.2
5.0X3.25-SD-5314S	20468398	6.5	8.0X3.25-SD-8314S	20468401	9.8	12X3.25-SD-12314S	20468405	17.4
6.0X3.25-SD-6314S	20468399	7.2	9.0X3.25-SD-9314S	20468402	10			
3.25-SF								
14.0X3.25-SF-14314	20468406	25.4	18X3.25-SF-18314S	20468408	34	24X3.25-SF-24314S	20468420	50
16.0X3.25-SF-16314	20468407	37.9	20X3.25-SF-20314S	20468409	43			
4.25-SD								
4.0X4.25-SD-4414S	20468421	6.1	7.0X4.25-SD-7414S	20468424	9.8	10.0X4.25-SD-10414	20468427	15.4
5.0X4.25-SD-5414S	20468422	8.9	8.0X4.25-SD-8414S	20468425	10.7	11.0X4.25-SD-11414	20468428	17.6
6.0X4.25-SD-6414S	20468423	8.4	9.0X4.25-SD-9414S	20468426	11.9			
4.25-SF								
12X4.25-SF-12414S	20468429	23	16.0X4.25-SF-16414	20468431	32.3	20X4.25-SF-20414S	20468433	43.4
14.0X4.25-SF-14414	20468430	28.5	18.0X4.25-SF-18414	20468432	39	24.0X4.25-SF-24414	20468434	65.2
5.25-SF								
6.0X5.25-SF-6514S	20468435	14	10X5.25-SF-10514S	20468439	19.2	16.0X5.25-SF-16514	20468443	38.3
7.0X5.25-SF-7514S	20468436	17.3	11.0X5.25-SF-11514	20468440	31.1	18X5.25-SF-18514S	20468444	42.6
8.0X5.25-SF-8514S	20468437	15.5	12X5.25-SF-12514S	20468441	27.3	20.0X5.25-SF-20514	20468445	51.5
9.0X5.25-SF-9514S	20468438	19.3	14.0X5.25-SF-14514	20468442	36.3			
5.25-E								
24.0X5.25-E-24514S	20468446	69.6						

continued on page 137

Flat Idlers

(continued)

Part #	SAP #	Weight	Part #	SAP #	Weight	Part #	SAP #	Weight
6.38-SF								
6.0X6.38-SF-6638S	20468447	15	10.0X6.38-SF-10638	20468451	21	16.0X6.38-SF-16638	20468455	41.3
7.0X6.38-SF-7638S	20468448	19.8	11.0X6.38-SF-11638	20468452	28.7	18X6.38-SF-18638S	20468456	47.2
8.0X6.38-SF-8638S	20468449	16.9	12X6.38-SF-12638S	20468453	28.4	20.0X6.38-SF-20638	20468457	57.5
9.0X6.38-SF-9638S	20468450	22.4	14.0X6.38-SF-14638	20468454	31.2			
6.38-E								
24.0X6.38-E-24638S	20468458	88.5						
8.38-E								
8.0X8.38-E - 8838S	20468459	32.4	12.0X8.38-E-12838S	20468463	39.7	20.0X8.38-E-20838S	20468467	75.6
9.0X8.38-E - 9838S	20468460	33.8	14.0X8.38-E-14838S	20468464	49.4	24.0X8.38-E-24838S	20468468	104.2
10.0X8.38-E-10838S	20468461	38.1	16.0X8.38-E-16838S	20468465	60.8			
11.0X8.38-E-11838S	20468462	40.6	18.0X8.38-E-18838S	20468466	69.3			
10.50-E								
10X10.50-E-101012	20468469	45.8	12X10.50-E-121012	20468471	52.8	16X10.50-E-161012S	20468473	80
11X10.50-E-111012	20468470	53.8	14X10.50-E-141012	20468472	65.7			
10.50-J								
18X10.50-J-181012S	20468474	110.8	20X10.50-J-201012	20468475	122.8	24X10.50-J-241012S	20468476	152.5
12.50-J								
12.0X12.50-J-12112	20468477	94.8	16X12.50-J-161212	20468479	117.4	20X12.50-J-201212	20468481	151.1
14X12.50-J-141212	20468478	107.9	18X12.50-J-181212	20468480	132	24X12.50-J-241212	20468482	175.5

Neothane® V-Belts

A different approach to V-belts

Neothane® V-belts can provide a different approach to V-belt power transmission for appliances and light-duty machinery. The features of the belt will make it possible to gain competitive advantages in many areas of application.

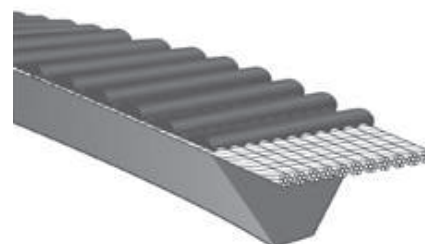

Part Number: 5M 710
5M 5mm (3/16 in.) top width
710 710mm (27.95 in.) outside length

Smooth operator

Smaller sheave diameters, higher speed ratios, shorter center distances and higher speeds in belt power transmission applications are possible. Elimination of double reduction drives, made possible by the higher speed ratios permitted, result in decreased space requirements for many applications. The precision characteristics of this belt give a smoothness of operation that reduces noise to a minimum in the appearances of a drive.

that keeps the load carrying cord in the same plane pulling together.

The low-maintenance V-belt alternative

This belt is ideal for machines with long warranty periods. The outstanding characteristics make it virtually maintenance-free and therefore reduce service costs. Greater horsepower can be utilized by the designer with reasonable belt life. Or, for a given amount of power to be transmitted, belt life can be greater than ever before.

Lengths Available

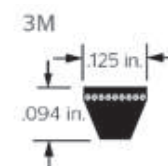

3M Nominal Top Width 1/8 in.*

Part #	Eff. Length (in.)	Part #	Eff. Length (in.)
3M180	7.09	3M265	10.43
3M185	7.28	3M272	10.71
3M190	7.48	3M280	11.02
3M195	7.68	3M290	11.42
3M200	7.87	3M300	11.81
3M206	8.11	3M307	12.09
3M212	8.35	3M315	12.40
3M218	8.58	3M325	12.80
3M224	8.82	3M335	13.19
3M230	9.06	3M345	13.58
3M236	9.29	3M355	13.98
3M243	9.57	3M365	14.37
3M250	9.84	3M375	14.76
3M258	10.16	3M387	15.24

*All parts are nonstock. Please check factory for availability. continued on page 139

Applications

Specialty belt for specific types of machines and equipment.

- > Machine tools
- > Computer industry
- > Woodworking machines
- > Appliances
- > Blowers
- > Medical industry

Key features & benefits

- > Ribbed top for transverse rigidity, flexibility and cool running conditions.
- > Narrow top width for use on narrow, small diameter sheaves and exceptional flexibility on short centers.
- > Cords are resistant to elongation or shrinkage, provide great strength and long flex life.
- > Polyurethane compounding for firmer grip, greater strength and high resistance to oil, heat, abrasion, ozone and fatigue.
- > Smooth machined sides for quiet running, vibration-free operation and uniform grip.
- > Sixty-degree angle cross section for uniform support

Contact your PTP Industrial Distributor or go to www.contitech.us to locate one.

Neothane® V-Belts

Lengths Available

3M Nominal Top Width 1/8 in.* (continued)

Part #	Eff. Length (in.)	Part #	Eff. Length (in.)	Part #	Eff. Length (in.)
3M400	15.75	3M500	19.69	3M630	24.80
3M412	16.22	3M515	20.28	3M650	25.59
3M425	16.73	3M530	20.87	3M670	26.38
3M437	17.20	3M545	21.46	3M690	27.17
3M450	17.72	3M560	22.05	3M710	27.95
3M462	18.19	3M580	22.83	3M730	28.74
3M475	18.70	3M600	23.62	3M750	29.53
3M487	19.17	3M615	24.21		

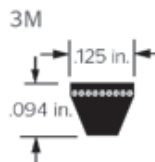

*All parts are nonstock. Please check factory for availability.

5M Nominal Top Width 3/16 in.

Part #	Eff. Length (in.)	Part #	Eff. Length (in.)	Part #	Eff. Length (in.)
5M280	11.02	5M475	18.70	5M800	31.50
5M290	11.42	5M487	19.17	5M825	32.48
5M300	11.81	5M500	19.69	5M850	33.46
5M307	12.09	5M515	20.28	5M875	34.45
5M315	12.40	5M530	20.87	5M900	35.43
5M325	12.80	5M545	21.46	5M925	36.42
5M335	13.19	5M560	22.05	5M950	37.40
5M345	13.58	5M580	22.83	5M975	38.39
5M355	13.98	5M600	23.62	5M1000	39.37
5M365	14.37	5M615	24.21	5M1030	40.55
5M375	14.76	5M630	24.80	5M1060	41.73
5M387	15.24	5M650	25.59	*5M1090	42.91
5M400	15.75	5M670	26.38	5M1120	44.09
5M412	16.22	5M690	27.17	5M1150	45.28
5M425	16.73	5M710	27.95	5M1180	46.46
5M437	17.2	5M730	28.74	5M1220	48.03
5M450	17.72	5M750	29.53	*5M1250	49.21
5M462	18.19	5M775	30.51	*5M1280	50.39
5M1320	51.97	5M1450	57.09	5M1650	64.96
5M1360	53.54	5M1500	59.06	5M1850	72.83
5M1400	55.12	5M1600	62.99		

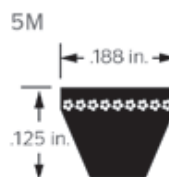

*Nonstock. Please check factory for availability.

7M Nominal Top Width 5/16 in.

Part #	Eff. Length (in.)	Part #	Eff. Length (in.)	Part #	Eff. Length (in.)
7M500	19.69	7M850	33.46	7M1400	55.12
*7M515	20.28	7M875	34.45	7M1450	57.09
7M530	20.87	7M900	35.43	7M1500	59.06
*7M545	21.46	7M925	36.42	7M1550	61.02
7M560	22.05	7M950	37.40	7M1600	62.99
7M580	22.83	7M975	38.39	7M1650	64.96
7M600	23.62	7M1000	39.37	7M1700	66.93
7M615	24.21	7M1030	40.55	7M1750	68.90
7M630	24.80	7M1060	41.73	7M1800	70.87
7M650	25.59	7M1090	42.91	7M1850	72.83
7M670	26.38	7M1120	44.09	7M1900	74.80
7M690	27.17	7M1150	45.28	7M1950	76.77
7M710	27.95	7M1180	46.46	7M2000	78.74
7M730	28.74	7M1220	48.03	*7M2060	81.10
7M750	29.53	7M1250	49.21	7M2120	83.46
7M775	30.51	7M1280	50.39	7M2180	85.83
7M800	31.50	7M1320	51.97	*7M2240	88.19
7M825	32.48	7M1360	53.54	*7M2300	90.55

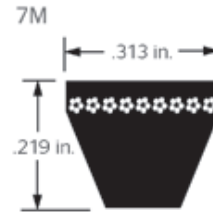

*Nonstock. Please check factory for availability.

11M Nominal Top Width 7/16 in.

Part #	Eff. Length (in.)	Part #	Eff. Length (in.)	Part #	Eff. Length (in.)
11M710	27.95	11M1060	41.73	11M1600	62.99
*11M730	28.74	*11M1090	42.91	11M1650	64.96
*11M750	29.53	11M1120	44.09	11M1700	66.93
*11M775	30.51	11M1150	45.28	*11M1750	68.90
11M800	31.50	11M1180	46.46	11M1800	70.87
11M825	32.48	11M1220	48.03	*11M1850	72.83
11M850	33.46	11M1250	49.21	11M1900	74.80
11M875	34.45	11M1280	50.39	11M1950	76.77
11M900	35.43	11M1320	51.97	11M2000	78.74
11M925	36.42	11M1360	53.54	11M2060	81.10
11M950	37.40	11M1400	55.12	11M2120	83.46
11M975	38.39	11M1450	57.09	11M2180	85.83
11M1000	39.37	11M1500	59.06	11M2240	88.19
11M1030	40.55	11M1550	61.02	11M2300	90.55

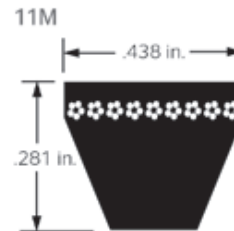

*Nonstock. Please check factory for availability.

Note: Rubber equivalents for 5M, 7M, 11M sizes are available in mandrel minimums.

Variable Speed Belts

Top performance at every speed

Continental ContiTech Variable Speed belts deliver the speed and horsepower the drives on your equipment were designed to achieve.

Continental ContiTech Variable Speed belts have excellent transverse rigidity and exceptional flexibility preventing buckling at minimum diameter settings where belt stresses are greatest. Firm gripping action in the contact area provides positive traction for precise, immediate response. Together, they assure reliable, predictable transmission of maximum power over the drive's full operating range.

And top performance also means that you get longer life from Continental ContiTech Variable Speed belts. That translates to less downtime for belt maintenance and more productivity from your equipment, which leads to greater operating economy by any measure.

Uniform cross section means less drive wear

The precision forming that goes into every one of our Variable Speed belts assures a completely uniform cross section. This allows even tracking and smooth running without any vibration problems. As a result, the life of the belt - as well as bearings, sheaves and other drive component - is significantly extended. Longer wear is a great way to save money and increase productivity.

Exceptional lengthwise flexibility allows for small pulleys

We build these belts thin with precise, uniform cogs on the underside for maximum lengthwise flexibility. They can be used on small pulley drives without any sacrifice of gripping action or cross rigidity. Cogging also minimizes bottom cracking, a major cause of premature failure.

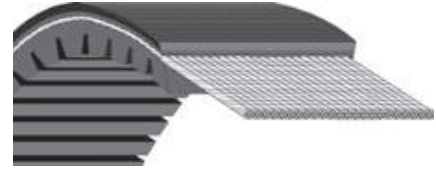

Part Number: 3226V585

32	32/16 in. top width
26	Angle of sheave groove
V	Variable speed profile - with aramid tensile member
585	58.5 in. pitch length Cut-edge, molded cog construction shown

True dimensional stability and higher horsepower capability for long belt life

Our aramid tension cords get their muscle from a special tempering for maximum strength and resilience. This gives Continental ContiTech Variable Speed belts the dimensional stability they need to carry more horsepower and experience less elongation over the life of the belt. In short, these Variable Speed belts provide you with longer life on the toughest drives.

Applications

For use on variable speed sheave drives requiring exact speed control and maximum range of speed changes. Ideal for recreational equipment, agricultural applications and machine tools.

- > Exercise equipment
- > Medical equipment
- > Farm equipment
- > Automobiles
- > Power equipment
- > Machine tools

Key features & benefits

- > Durable variable speed profile.
- > Super strong aramid tensile members.
- > Fiber-reinforced, latest compounded technology compression section.
- > High-horsepower capacity.
- > Milled edge construction for superior dimensional stability.
- > Oil, heat, ozone and abrasion resistant.

To learn more, visit www.contitech.us.

Widths and Lengths Available

Metric and asymmetric sizes available in minimum quantities.

Cut-Edge Construction

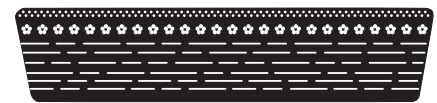

Variable Speed Belts

Stock Part #

1228V	1622V336	1922V	1922V756	2026V445	2322V681	2436V	2530V850
1228V255	1626V	1922V256	1922V806	2026V607	2322V701	2436V331	2530V890
1422V	1626V262	1922V277	1922V846	2126V	2322V721	2526V	2530V934
1422V235	1626V290	1922V282	1922V891	2126V309	2322V801	2526V314	2530V990
1422V240	1626V293	1922V298	1922V966	2126V365	2322V826	2530V	2530V1090
1422V270	1626V304	1922V302	1922V1146	2226V	2322V681	2530V300	2626V
1422V290	1626V330	1922V321	1926V	2226V307	2322V701	2436V	2626V369
1422V300	1626V339	1922V332	1926V250	2230V	2322V721	2436V331	2626V388
1422V330	1626V380	1922V338	1926V275	2230V266	2322V801	2526V	2630V
1422V340	1626V384	1922V363	1926V407	2230V273	2322V826	2526V314	2630V345
1422V360	1626V395	1922V381	1926V427	2230V275	2322V846	2530V	2630V395
1422V400	1626V411	1922V386	1930V	2230V285	2322V886	2530V300	2636V
1422V420	1626V428	1922V403	1930V366	2230V326	2322V921	2530V335	2636V332
1422V440	1626V440	1922V417	1930V400	2230V375	2322V1001	2530V490	2822V
1422V460	1626V455	1922V426	1930V425	2322V	2322V1061	2530V500	2822V778
1422V466	1626V513	1922V443	1930V431	2322V329	2322V1271	2530V530	2826V
1422V470	1626V517	1922V454	1930V450	2322V347	2326V	2530V550	2826V452
1422V480	1626V597	1922V460	1930V491	2322V364	2326V310	2530V575	2830V
1422V540	1626V604	1922V484	1930V500	2322V384	2326V359	2530V595	2830V337
1422V600	1626V658	1922V526	1930V541	2322V396	2330V	2530V600	2830V363
1422V660	1626V700	1922V544	1930V560	2322V421	2330V273	2530V610	2830V366
1422V720	1628V	1922V604	1930V591	2322V434	2330V338	2530V630	2830V367
1422V780	1628V210	1922V630	1930V600	2322V441	2426V	2530V660	2830V393
1430V	1628V315	1922V646	1930V641	2322V461	2426V343	2530V670	2830V396
1430V215	1632V	1922V666	1930V691	2322V481	2430V	2530V690	2830V422
1430V315	1632V210	1922V686	1930V750	2322V521	2430V297	2530V700	2830V428
1430V450	1822V	1922V706	1930V991	2322V541	2430V302	2530V730	2836V
1430V500	1822V328	1922V721	1930V1091	2322V601	2430V319	2530V750	2836V343
1622V	1828V	1922V726	2026V	2322V621	2430V345	2530V790	2836V350
1622V270	1828V368	1922V751	2026V422	2322V661	2430V379	2530V840	2836V380

continued on page 143

Variable Speed Belts

Widths and Lengths Available

Metric and asymmetric sizes available in minimum quantities.

Variable Speed Belts (continued)

Stock Part #							
2926V	2926V1006	3226V1083	3230HV723	3830V517	4430V660	4430V1460	4836V950
2926V366	2926V1026	3230V	3230HV821	3830V580	4430V670	4430V1610	4836V1000
2926V400	2926V1086	3230V419	3230HV856	3830V587	4430V690	4436V	4836V1060
2926V426	2926V1106	3230V481	3230HV931	3836V	4430V700	4436V525	4836V1120
2926V471	2926V1146	3230V600	3230HV960	3836V418	4430V710	4436V551	4836V1180
2926V477	2930V	3230V621	3230HV1060	3836V426	4430V718	4436V646	4836V1250
2926V486	2930V348	3230V630	3236V	3836V654	4430V730	4630V	5130V
2926V491	2930V420	3230V670	3236V369	3836V794	4430V740	4630V650	5130V732
2926V521	3226V	3230V710	3236V389	4030V	4430V750	4630V663	5130V787
2926V534	3226V392	3230V750	3236V432	4030V590	4430V760	4630V733	5228V
2926V546	3226V395	3230V771	3430V	4036V	4430V780	4636V	5228V930
2926V574	3226V400	3230V800	3430V424	4036V541	4430V790	4636V613	5230V
2926V586	3226V433	3230V850	3430V476	4036V574	4430V800	4830V	5230V662
2926V606	3226V439	3230V900	3430V493	4230V	4430V850	4830V602	5230V734
2926V616	3226V450	3230V1120	3432V	4230V556	4430V900	4830V653	5230V867
2926V636	3226V465	3230V1180	3432V450	4230V605	4430V910	4830V699	5636V
2926V646	3226V505	3230HV	3432V456	4230V653	4430V930	4830V730	5636V774
2926V666	3226V514	3230HV528	3432V480	4430V	4430V950	4830V750	5830V
2926V686	3226V545	3230HV546	3432V484	4430V510	4430V970	4830V850	5830V756
2926V706	3226V585	3230HV553	3432V528	4430V530	4430V1000	4830V970	5836V
2926V726	3226V603	3230HV570	3432V534	4430V548	4430V1030	4830V1070	5836V737
2926V776	3226V650	3230HV585	3630V	4430V555	4430V1060	4836V	6236V
2926V786	3226V663	3230HV603	3630V455	4430V560	4430V1090	4836V618	6236V607
2926V834	3226V723	3230HV613	3726V	4430V570	4430V1120	4836V655	6236V725
2926V856	3226V783	3230HV620	3726V558	4430V578	4430V1150	4836V670	6236V762
2926V891	3226V843	3230HV626	3826V	4430V600	4430V1180	4836V710	
2926V906	3226V903	3230HV644	3826V465	4430V610	4430V1250	4836V800	
2926V921	3226V963	3230HV685	3830V	4430V630	4430V1320	4836V850	
2926V966	3226V1023	3230HV702	3830V510	4430V652	4430V1410	4836V900	

Flat Belting (Truly Endless)

Truly Endless synthetic cord belts

These belts are extremely flexible and exceptionally long-lasting, even when operating over small pulleys. They are made in four different weights to meet any service requirement.

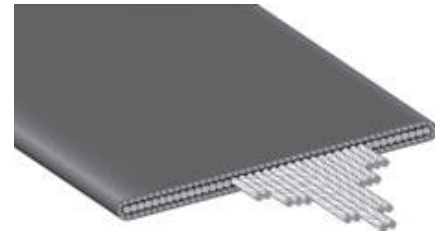

Part Number: Flat "L" belt

Continental ContiTech Flat Cord transmission belts are made with a single-layer, reinforcing section for a cross section which is thinner by 25% or more compared to plied belts of equal horsepower capacity. The high-tensile strength, multistrand synthetic cords used in Flat Cord belts provide maximum strength and minimum elongation.

Flat belts are furnished in an abrasion-resistant rubber construction. They can be made with oil-resisting synthetic rubber compounds on special order in widths from 1 to 36 inches and lengths from 25 inches to 135 feet.

Truly Endless Flat 250 and 450 Steel Cable belts

These belts are constructed with steel cable for heavy-duty drives. These belts include the features of Flat Cord belts with the added advantage that the load-carrying members are very finely stranded steel cables instead of synthetic rope cords. All Flat 250 and 450 belts are made with oil-resisting compounds throughout, which gives them greatly increased life under operating conditions where oil is present.

They generally handle much higher horsepower loads than any conventional fabric or cord construction belt, are extremely flexible and readily conform to small pulleys.

Truly Endless Multiple Ply belts

The Multiple Ply belt is another product in the Truly Endless line. The round-and-round fabric construction can be split into multiple belts from one slab, representing great cost savings.

Various carcass materials are available for multiple ply belts, depending on the application. The most highly recommended are polyester/nylon, cotton, nylon, polyester, etc. These belts can be supplied with rubber covers, friction surface or bareback. We can supply V-guides, banner edges, cleats, drive lugs and rough top surfaces.

Applications

Handles a wide range of horsepower and speeds in both industrial and agricultural drives.

- › Harvesting equipment
- › Textiles and forestry
- › Hay equipment
- › Industrial equipment
- › Direct gear Drive replacement
- › Soil handling
- › Food processing
- › Chain replacement
- › Health and fitness
- › Material handling

Key features & benefits

- › Smooth, quiet operation and long belt life.
- › Uniform belt surface with no splicing.
- › High-tensile strength.
- › High coefficient of friction.
- › Lightweight.
- › No lubrication necessary.
- › Transverse rigidity.

We manufacture a complete line of Flat belting from Truly Endless and Multiple Ply belts to Regulator Power Strap Flat belts for the health and fitness industry.

To learn more, visit www.contitech.us.

Flat Belting (Truly Endless)

Available Sizes

Press Cured belts 30 to 34 inches wide require a minimum length of 14 feet (168 inches).
Press Cured belts above 36 inches wide require a minimum length of 17 feet (204 inches).

NOTE: Belting made by continuous build endless method has a length tolerance of plus or minus 1%.

Flat Belting (Truly Endless)

Per Foot	Thickness (in.)	Cord
Flat L (Drum Cured)	8/64	Rayon
Flat L (Press Cured)	15/64	Rayon
Flat M (2 to 9 in. wide included) (1 x 2 env)	16/64	Rayon
Flat M (10 to 28 in. wide included) (2 x 3 env)	24/64	Rayon
Flat C	25/64	Polyester
Flat H	29/64	Polyester
Flat 250 (4 to 36 in.)	11/64	Steel
Flat 250 (4 to 36 in.)	15/64	Steel
Flat 250 (10 in. & over)	19/64	Steel
Flat 450 (to 10 in.)	17/64	Steel
Flat 450 Steel (10 in. & over)	21/64	Steel

Endless Belts

Belt Type	Minimum Width (in.)	Maximum Width (in.)	Minimum Length (in.)	Maximum Length (in.)
Drum Cured				
Flat L	1	10	24½	120
Flat M	2	28	24½	169%
Press Cured				
Flat M	2	36	120	135
Flat C	4	36	120	135
Flat H	4	36	120	135
Flat 250 Steel*	4	36	120	135
Flat 450 Steel	10	36	120	135

*Flat 250 Steel belts under 120 in. maximum width of 18 in., over 120 in. limitations do not apply (up to 38 in.).

Truly Endless Belts

Available Drum Sizes

Drum built belts are made only in raw-edge construction in lengths shown below. Lengths other than shown below are available with procurement of tooling.

Contact customer service for availability.

Truly Endless Belts

Drum Sizes (in.)					
10 $\frac{3}{8}$	37	50 $\frac{3}{16}$	68	89 $\frac{1}{2}$	114 $\frac{1}{4}$
12	37 $\frac{1}{8}$	51 $\frac{1}{8}$	68 $\frac{1}{2}$	90 $\frac{1}{8}$	115
13 $\frac{1}{8}$	37 $\frac{3}{4}$	51 $\frac{1}{8}$	68 $\frac{3}{4}$	91	115 $\frac{1}{4}$
15 $\frac{3}{4}$	38	52	69	92	116 $\frac{1}{2}$
24 $\frac{1}{2}$	38 $\frac{5}{8}$	52 $\frac{5}{16}$	69 $\frac{5}{8}$	92 $\frac{1}{2}$	117 $\frac{3}{4}$
25 $\frac{1}{2}$	40	52 $\frac{1}{2}$	70	92 $\frac{3}{4}$	120
26 $\frac{1}{2}$	40 $\frac{1}{2}$	53 $\frac{3}{8}$	71	93 $\frac{1}{2}$	121 $\frac{1}{2}$
27 $\frac{1}{8}$	40 $\frac{3}{4}$	54	71 $\frac{1}{2}$	94	125
27 $\frac{1}{4}$	41 $\frac{1}{4}$	54 $\frac{1}{8}$	72	94 $\frac{1}{4}$	126
28 $\frac{11}{16}$	41 $\frac{1}{8}$	55	74	95	128
29 $\frac{1}{8}$	41 $\frac{1}{4}$	56	74 $\frac{3}{4}$	96	130 $\frac{11}{16}$
30 $\frac{3}{16}$	42 $\frac{1}{8}$	56 $\frac{3}{8}$	76 $\frac{1}{2}$	96 $\frac{1}{2}$	135 $\frac{3}{4}$
30 $\frac{13}{16}$	43 $\frac{1}{2}$	58	78	98	138 $\frac{3}{8}$
31 $\frac{1}{2}$	43 $\frac{3}{4}$	58 $\frac{1}{2}$	79	99 $\frac{1}{4}$	141
32 $\frac{1}{8}$	44 $\frac{1}{8}$	58 $\frac{3}{8}$	79 $\frac{1}{2}$	101	143 $\frac{3}{4}$
32 $\frac{1}{4}$	46 $\frac{1}{4}$	59	80	101 $\frac{1}{2}$	145
32 $\frac{3}{8}$	46 $\frac{1}{2}$	60	80 $\frac{1}{4}$	102 $\frac{1}{2}$	147 $\frac{3}{4}$
33	47 $\frac{3}{16}$	61 $\frac{1}{2}$	81	103	151 $\frac{1}{4}$
33 $\frac{11}{16}$	47 $\frac{3}{8}$	62	82 $\frac{1}{4}$	103 $\frac{1}{2}$	154
34 $\frac{1}{4}$	47 $\frac{1}{8}$	63	82 $\frac{3}{4}$	104 $\frac{1}{2}$	156
34 $\frac{9}{16}$	48 $\frac{1}{4}$	63 $\frac{1}{2}$	84	105	157
35 $\frac{1}{8}$	48 $\frac{3}{8}$	64 $\frac{1}{8}$	85	108 $\frac{1}{2}$	159 $\frac{1}{2}$
35 $\frac{1}{2}$	49 $\frac{1}{4}$	65	86	109 $\frac{3}{4}$	162
35 $\frac{13}{16}$	49 $\frac{1}{8}$	66	86 $\frac{1}{2}$	111 $\frac{3}{16}$	162 $\frac{1}{2}$
36	49 $\frac{11}{16}$	66 $\frac{3}{8}$	88	112 $\frac{1}{2}$	163
36 $\frac{1}{2}$	50	67	89	113 $\frac{1}{2}$	168 $\frac{3}{8}$

Bowling Machines

Available Parts

AMF

AMF Part #	Continental ContiTech Part #
000-022-099	A112
000-025-731	8350
000-026-753	CARPET
000-027-710	2L360
000-028-864	8690
000-028-865	8695
000-029-600	8640
030-003-912	A133
030-005-197	B128
030-005-453	8520
030-008-671	A133
030-008-792	A133
070-001-424	2L360
070-002-005	B190
82-70-2013	8685
000-029-433	3L360
057-001-003	4L410
146-004-772	5M1850
146-004-775	5M925
208-111-174	3L450
070-011-064	3L450
070-011-147	3L380
070-011-148	3L400
234-001-147	8595
702-504-012	A68
702-504-013	A34

Brunswick

Brunswick Part #	Continental ContiTech Part #
10-635112	8555
10-635126	8505
10-635303	A90
10-635304	A64
10-635308	4L335
10-635309	A80
10-635314	4L350
12-150113	8620
12-300082-3	8625
12-400034-2	A75
12-400034-3	A105
12-400034-4	A120
12-400034-5	B195
12-400223	8615
12-400227	B205
12-400314	AX112
12-400329	A77
12-200947	8560
116-31-290	3L310
10-635317	AX90
53-530230-2	8420
53-520148-2	8430

Axial Fan Pd® Belts

Applications

Specific application power transmission synchronous belts used primarily in the chemical, petroleum and refining industries.

Key features & benefits

- > Special Fin Fan® construction.
- > Universal tooth profile drops into existing HTD® sprockets.
- > Quiet tooth engagement.
- > High-grade engineered rubber compound.
- > Fiberglass tension cords for excellent resistance to shrinkage and elongation.
- > Oil, heat, ozone and abrasion resistance.
- > Low-maintenance/high-efficiency rating.

To learn more, visit www.contitech.us.

Available Sizes

Specific application power transmission synchronous belts used primarily in the chemical, petroleum and refining industries.

Axial Fan Pd® Belts

14mm width

Part #	SAP #	# of Teeth
3150 14M 55\FFAN	20081711	225
3150 14M 85\FFAN	20081712	225
3360 14M 55\FFAN	20081835	240
3360 14M 85\FFAN	20081836	240
3500 14M 55\FFAN	20081963	250
3500 14M 85\FFAN	20081964	250
3850 14M 55\FFAN	20082161	275
3850 14M 85\FFAN	20082162	275

Fin Fan® is a registered trademark of the Hudson Products Company.



Part Number: 3150 14M 55\FFAN

3150	3150mm pitch length
14	14mm pitch
55	55mm wide
\FFAN	Special Fin Fan® construction

Axial Fan Pd® Sprockets

Available Sizes

Axial Fan Pd® Sprockets

14mm width

Part #	SAP #	Weight*
F168-14M-40-E	20182173	88.0
F168-14M-55-E	20182174	94.0
F168-14M-85-E	20182175	108.0
F192-14M-40-E	20182176	102.0
F192-14M-55-E	20182177	110.0
F192-14M-85-E	20182178	130.0
F216-14M-40-E	20182179	136.0
F216-14M-55-E	20182180	145.0
F216-14M-85-E	20182181	161.0

*Weight does not include bushing.

Cotton Cleaners

Available Sizes

Cotton Cleaners

Size	Pitch Length (in.)	# of Teeth
61CCB142F	61	61
63CCB165F	63	63
64CCB170F	64	64
65CCB175F	65	65



Part Number: 64 CCB

64 64 in. pitch length
CCB 1 in. pitch

Applications

Synchronous belts specially designed for driving the cylinders on Cotton Gin Incline cleaner machines.

Key features & benefits

- > Aramid tensile cords.
- > Long service life in harsh environments.

Continental Elite® Poly-V® Belts

With Quiet-Channel Technology™

Applications

For passenger cars and light- and heavy-duty trucks.

Key features & benefits

- > Specially treated tension members to maintain tension and resist elongation on both locked center drives and spring tension systems.
- > Fiber-reinforced rubber helical cogged ribs offer maximum cord support and wear resistance for unsurpassed performance in high horsepower applications.
- > The backing is tough, coated fabric material impregnated with premium rubber for heat and oil resistance to provide high coefficient of friction needed to drive flat pulleys.
- > Unique helical cog design runs quieter than standard cogged belts.



Part Number: 4061025

4	K section Poly-V
06	6 ribs
1025	102 3/16 in. length

Continental Elite® V-Belts

Applications

For passenger cars and light- and heavy-duty trucks.

Key features & benefits

- > High-strength Vytacord® tension members resist shockload failure. Low-elongation properties assure uniform performance over the long life of the belt.
- > Fiber-reinforced rubber helical cogs offer greater flexibility which reduces cracking and fatigue in the cushion member.
- > Tension fabric impregnated with engineered oil-resistant rubber reduces surface fatigue and resists cracking.
- > Rubber edges maintain positive, no-slip contact with pulley grooves for reliable energy transfer.

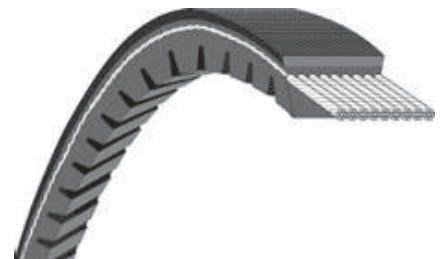

Part Number: 15456

15	15/32 in. top width
456	45 5/8 in. outside length

To learn more, visit www.contitech.us.



Continental Elite® Timing Belts

With OEMfit Technology™

Applications

Continental Elite® Timing belts are designed to deliver precise timing over a long service life in demanding automotive cam applications.

Key features & benefits

- › Precision-molded teeth made of synthetic polymers provide high strength, shear resistance and environmental resistance to assure long, dependable life.
- › Specially woven and chemically treated fabric is impregnated with our high-grade rubber polymers to reduce pulley friction and provide outstanding resistance to abrasion, oil and ozone.
- › Special fiberglass tension members are dimensionally stable and high in strength, starting out precise and dependable and staying that way.
- › Durable polymer backing protects the load-carrying cords from oil, abrasion and ozone. It also keeps the cords in place so they pull together smoothly and evenly.

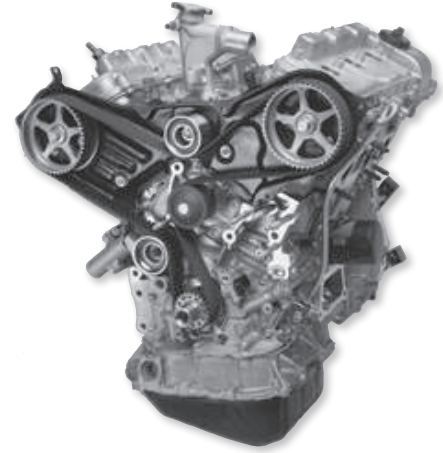

Part Number: 40138

40	Automotive Timing Belt
138	Industry Standard Description

Continental Elite® Truck Refrigeration Belts

Applications

Main drive belts for truck refrigeration units, especially designed for long life on mule drives and backside idler drives. Accessory drives are also found in the refrigeration units and are driven by Hex belts, Torque-Flex® belts and Insta-Power® belts.

Key features & benefits

- › Premium rubber-impregnated fabric resists oil, heat and wear.
- › High-strength Vytacord® tension members improve flex life, eliminate excess elongation and increase resistance to shock loads.
- › Cushion section is made of premium rubber to resist heat and wear.



Part Number: 41047

Application Guides and Available Sizes

Continental Elite Poly-V® Belts, V-Belts, Truck Refrigeration Belts, Special Truck Belts and Timing Belts

Note: For an application guide and available sizes, ask your distributor for the following catalogs:

Catalog Description	Part #	Catalog Description	Part #
Car & Light Truck Application Guide (Current to 1994)	20035740	Medium to Heavy Duty Truck Application Guide (Current to 1990)	20049138
Car & Light Truck Application Guide (1993 & Prior)	20049146	Medium to Heavy Duty Truck Application Guide (1989 & Prior)	20108695

Belt Size Information

HY-T® Classical V-Belts and Torque-Flex®

Section	Nominal Top Width (in.)	How to Obtain Effective Outside Length Up To 210 in.	How to Obtain Effective Outside Length Over 210 in.
A, AX	1/2 (.500)	Add 2.1 in. to Part Number Ex: A20 = 22.1 in.	Add 2.1 in. to Part Number Ex: A220 = 22.1 in.
B, BX	21/32 (.656)	Add 2.9 in. to Part Number Ex: B100 = 102.9 in.	Add 1.4 in. to Part Number Ex: B240 = 241.4 in.
C, CX	7/8 (.875)	Add 4.2 in. to Part Number Ex: C100 = 104.2 in.	Add 2.2 in. to Part Number Ex: C240 = 242.7 in.
D, DX	1¼ (1.250)	Add 5.2 in. to Part Number Ex: D180 = 185.2 in.	Add 2.7 in. to Part Number Ex: D240 = 242.7 in.
E	1½ (1.500)	Add 7.0 in. to Part Number Ex: E180 = 187.0 in.	Add 3.5 in. to Part Number Ex: E360 = 363.5 in.

HY-T® Wedge and Wedge TLP™

Section	Nominal Top Width (in.)	Lengths
3V, 3VX, 3VT	3/8 (.375)	Belt Number indicates nominal
5V, 5VX, 5VT	5/8 (.625)	Outside Length
8V, 8VT	1 (1.000)	Example: 3VX475 = 47.5 in.

FHP

Section	Nominal Top Width (in.)	Lengths
2L	1/4 (.250)	Belt Number indicates nominal
3L	3/8 (.375)	Outside Length
4L	1/2 (.500)	
5L	21/32 (.656)	Example: 4L400 = 40.0 in.

Positive Drive

Pitch	Distance from center of one tooth to center of next MXL = .080 in. XL = .200 in. L = .375 in. H = .500 in. XH = .875 in. XXH = 1.250 in.
Width	Last digits of belt number are the width in in. and tenths Example: 240XL025 = 1/4 in. width
Length	First digits of belt number are the pitch length in in. and tenths Example: 240XL025 = 24.0 in. pitch length

Poly-V®

Section	Width Per Rib	Nominal Top Width (in.)	Lengths
J	.092	.16	First digits are pitch length in in. and tenths
L	.185	.38	Example: 180J4 = 18.0 in.
M	.370	.66	J = Poly-V cross section 4 = Number of ribs

Variable Speed

Top Width	First two digits of belt number indicate belt top width in sixteenths of an in. Example: 3226V585 = 32/16 in. or 2 in. top width
Angle	Second two digits of belt number indicate the pulley angle Example: 3226V585 fits a 26° angle pulley
Length	Last digits of belt number are the pitch length Example: 3226V585 = 58.5 in. pitch length

Technical Information

Sprocket installation

Follow all safety policies and requirements of federal, state and local authorities, as well as the regulation of the employer, when working on power equipment. Always lock out the power source to the machinery before performing any work.

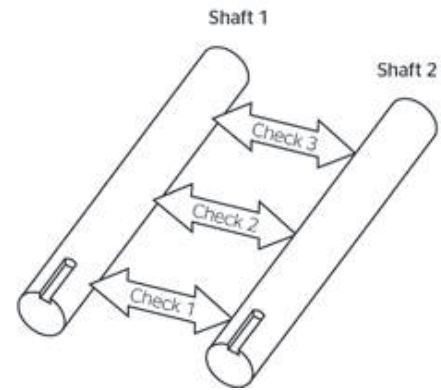

Preparation

OBJECTIVE: Verify that all necessary tools and parts are available and ready for installation.

1. SilentSync® belts and sprockets are identified with a unique Color Spectrum System. The seven colors used for identification are Yellow, White, Purple, Blue, Green, Orange and Red. Each color represents a different size so that Blue belts are made to operate with Blue sprockets. Make sure the same color belt and sprockets have been obtained. When installing Falcon Pd®, Hawk Pd® and Blackhawk Pd® it is also important that the correct sprocket width is used.

2. The following tools are recommended for proper belt and sprocket installation.

- › Straightedge
- › Socket and open end wrenches
- › Torque wrench
- › Belt tension gauge
- › Laser Alignment
- › Tape measure
- › File and sandpaper
- › Clean cloth
- › Deflection force values for tensioning the belt

3. Make sure the components are ready for installation. Clean all shafts, removing any nicks or burrs. Clean all mating surfaces of the sprocket, bushing and shaft. No lubrication or anti-seize solution should be used on any of these surfaces, including threaded holes. Use of lubrication can create higher torque, which will cause premature failure.

4. Make sure the shafts are true and parallel by accurately measuring the distance between the shafts at three points along the shaft. The distance between the shafts should be the same at all three points as shown. Also make sure the shafts are rigidly mounted. Shafts should not deflect when the belt is tensioned.

Sprocket and bushing installation

OBJECTIVE: Verify that all necessary tools and parts are available and ready for installation.

1. For conventional mounting, insert bushing into the sprocket, aligning the tapped holes in the bushing flange with the drilled holes in the sprocket hub.

2. Insert capscrews through the drilled holes and into the tapped holes.

3. Insert the key into the keyseat of the shaft.

4. With capscrews to the outside, place the sprocket and bushing assembly on the shaft, positioning the assembly with the bushing flange towards the shaft bearings. Reverse mounting the "Quick Detachable" (QD) bushing can be advantageous for some applications.

5. Repeat Steps 1 through 4 for the other sprocket.

6. Check that the teeth of both sprockets are pointing in the same direction when installing SilentSync® sprockets.

7. Snug the capscrews so that the sprocket/bushing assembly can still move on the shaft.

8. Align the sprockets using a straightedge. Check for contact in four places as shown. Do not use bearings or drive shafts as reference points for sprocket alignment. Continental ContiTech Laser Alignment Tool provides an alternative method for checking alignment.

See pages 172-174 for tools offered and how to order.

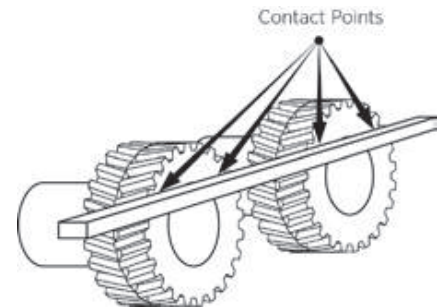

Sprocket and bushing installation

9. Using a torque wrench, tighten the capscrews to the torque values listed below. If there is not a gap of 1/8 to 1/4 inch between the bushing flange and the sprocket hub, then disassemble the parts and determine the reason for the faulty assembly.

10. The sprocket will draw onto the bushing during tightening. Always recheck alignment after tightening the capscrews. If alignment has changed, return to Step 7 (on page 153).

11. Tighten the setscrews over the keyway to the torque values listed in the table below.

12. If the sprockets are straight bore, use the above alignment procedure and then tighten the setscrews to the correct torque for the setscrew size listed in the Torque Specifications table.

QD® bushings can be installed with the capscrews on either side, excluding H, M and N sizes. Drives with opposing shafts require one of the sprockets be mounted with the capscrews on the flange side and one with the capscrews on the hub side.

Torque Specifications

Bushing	Capscrew Torque		Setscrew Torque (in.-lb.)	Setscrew Size (in.)
	in.-lb.	ft.-lb.		
H	108	9	-	-
SH	108	9	87	1/4
SDS	108	9	87	1/4
SK	180	15	87	1/4
SF	360	30	166	5/16
E	720	60	290	3/8
F	900	75	290	3/8
J	1620	135	290	3/8
M	2700	225	290	3/8
N	3600	300	620	1/2

Technical Information

Belt installation and tensioning

OBJECTIVE: Continental ContiTech Synchronous timing belts must be installed and tensioned properly to ensure optimum performance. Sprocket alignment must be preserved while tensioning the drive.

Before beginning, inspect the belt for damage and verify that the sprockets are properly mounted. Refer to sprocket and bushing manufacturer installation procedure. Belts should never be crimped or bent to a diameter less than the minimum sprocket diameter, approximately 2.5 inches for 8mm belts and 5 inches for 14mm belts.

1. Shorten the center distance or release the tensioning idler to install the belt. Do not pry the belt onto the sprocket. Refer to the following Center Distance Allowance tables for required center distance adjustment.

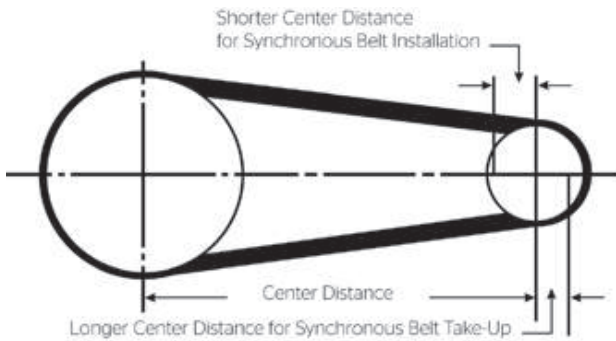

Apply the following center distance allowances for the Hawk Pd® and Falcon Pd®. A center distance adjustment or decrease in center distance, is necessary to install a belt. In addition, an increase in center distance will be necessary for proper tensioning. If you install a belt together with sprockets, allow the following decrease in center distance for installation and an increase in center distance for tensioning.

Pitch Length Range (mm)	Allowance (decrease) for Installation	Allowance (increase) for Take-Up
	8m, 14m Belts (mm/in.)	8m, 14m Belts (mm/in.)
Less than 1525	2.5/0.1	2.5/0.1
1525-3050	5.0/0.2	5.0/0.2
Greater than 3050	7.5/0.3	7.5/0.3

If you install a belt over one flanged sprocket and one unflanged sprocket with the sprockets already installed on the drive, allow the following decrease in center distance for installation and increase in center distance for tensioning.

Pitch Length Range (mm)	Allowance (decrease) for Installation		Allowance (increase) for Take-Up
	8m Belts (mm/in.)	14m Belts (mm/in.)	8m, 14m Belts (mm/in.)
Less than 1525	22.5/0.9	36.5/1.4	2.5/0.1
1525-3050	25.0/1.0	39.0/1.5	5.0/0.2
Greater than 3050	27.5/1.1	41.5/1.6	7.5/0.3

If you install the belt over two flanged sprockets that are already installed on the drive, allow the following decrease in center distance for installation and increase in center distance for tensioning.

Pitch Length Range (mm)	Allowance (decrease) for Installation		Allowance (increase) for Take-Up
	8m Belts (mm/in.)	14m Belts (mm/in.)	8m, 14m Belts (mm/in.)
Less than 1525	34.5/1.4	59.2/2.3	2.5/0.1
1525-3050	37.0/1.5	62.0/2.4	5.0/0.2
Greater than 3050	39.5/1.6	64.5/2.5	7.5/0.3

Consider the following center distance allowances when installing SilentSync® sprockets. Since flanges are not necessary on SilentSync® drives, only one table of center distance allowances is provided.

Pitch Length Range (mm)	Allowance (decrease) for Installation		Allowance (increase) for Take-Up
	8m Belts (mm/in.)	14m Belts (mm/in.)	8m, 14m Belts (mm/in.)
Less than 1525	10.1/0.4	15.2/0.6	2.5/0.1
Greater than 1525	15.2/0.6	17.8/0.7	5.0/0.2

2. Place the belt on each sprocket and ensure proper engagement between the sprocket and belt teeth.
3. Lengthen the center distance or adjust the tensioning idler to remove any belt slack.
4. Using a tape measure, measure the span length of the drive. Refer to dimension "P" in the diagram. The span length can be calculated using the formula at the right.
5. Place a straightedge or reference line across the top of the belt.
6. Determine the proper deflection force to tension the belt. Deflection forces are given in the following tables. Deflection forces are also given on the output of the MaximizerPro™ computer drive analysis.
 - a. If using a tension gauge, the deflection scale is calibrated in inches of span length. Check the force required to deflect the belt the proper amount. There is an O-ring to help record the force. If the measured force is less than the required deflection force, lengthen the center distance. If the measured force is greater than the required deflection force, shorten the center distance. See chart on page 157 for deflection values and tension gauges available.
 - b. If using other means to apply force to the belt, adjust the center distance so that the belt is deflected 1/64 per inch of span length when the proper force is applied. See chart on page 158 regarding TensionRite® Belt Frequency Meter which calculates belt tension by measuring span vibrations.

7. After the belt is properly tensioned, lock down the center distance adjustments and recheck the sprocket alignment.
8. If possible, run the drive for approximately 5 minutes with or without load. Stop the drive and lock out the power source and examine alignment, capscrew torque and belt tension. Adjust the center distance to increase the belt tension to the "New" value in the Deflection Principle table below. Lock down the drive adjustments and recheck tension.
9. Recheck the belt tension, alignment and capscrew torque after 8 hours of operation to ensure the drive has not shifted.

Deflection Principle

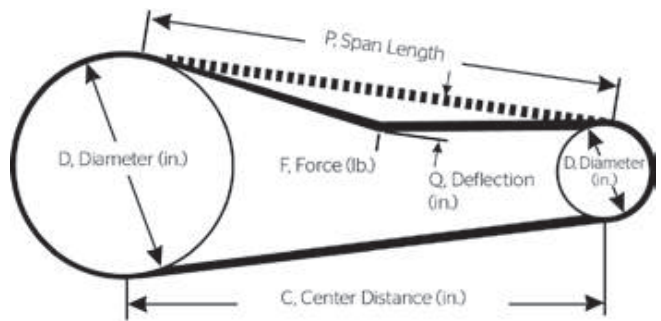

- F = Deflection Force
- q = Deflection, 1/64 in. per in. of span length
- C = Center Distance
- D = Large Sprocket Pitch Diameter
- d = Small Sprocket Pitch Diameter
- P = Span Length

$$P = \sqrt{C^2 - \left(\frac{D-d}{2}\right)^2}$$

Technical Information

Belt installation and tensioning

Deflection Forces for Belt Tensioning (lb.)

Belt Type	0-100 RPM		101-1000 RPM		1000-Up RPM	
	New Belt	Used Belt	New Belt	Used Belt	New Belt	Used Belt
SilentSync®						
Yellow	15	11	12	8	9	7
White	30	21	24	17	19	13
Purple	60	43	47	34	38	27
Blue	54	38	44	31	38	27
Green	60	57	66	47	57	41
Orange	107	76	88	63	76	55
Red	161	115	131	94	115	82
Falcon Pd®						
8GTR 12	24	17	14	10	9	7
8GTR 21	42	30	25	18	16	12
8GTR 36	72	51	42	30	27	21
8GTR 62	124	88	72	52	47	36
14GTR 20	38	29	31	23	28	21
14GTR 37	70	54	57	43	52	39
14GTR 68	129	99	105	78	95	71
14GTR 90	171	131	140	104	126	95
14GTR 125	238	181	194	144	175	131
Blackhawk Pd®						
8MBH12	12	9	9	7	7	5
8MBH 22	23	17	16	12	13	10
8MBH 35	36	26	26	19	21	16
8MBH 60	62	45	45	33	36	27
14MBH 20	36	26	27	20	23	17
14MBH 42	76	55	57	42	49	36
14MBH 65	117	85	89	65	76	55
14MBH 90	162	118	123	90	105	77
14MBH 120	217	157	164	119	139	102
Hawk Pd®						
8M 20	15	11	13	10	12	9
8M 30	23	17	20	15	19	14
8M 50	39	29	35	26	32	24
8M 85	69	50	61	45	56	41
14M 40	47	34	38	28	32	24
14M 55	70	51	56	41	48	35
14M 85	116	84	93	68	79	58
14M 115	162	118	130	95	110	80
14M 170	249	181	201	146	171	125

TensionRite® Small Tension Tester

Application

≤30 lb. deflection force



Part Number: 20044882

TensionRite® Large Tension Tester

Application

≥200 lb. deflection force



Part Number: 20039447

1. The table values are typically larger than necessary to cover the broad rpm range.
2. For drives where hub loads are critical and high speed drives or other drives with special circumstances, the table values (deflection force, installation tension) should be calculated.
3. Consult the Web site for detailed information on using the frequency-based tension gauges.
4. Continental ContiTech offers three different tension gauges for properly tensioning SilentSync® Hawk Pd or Blackhawk Pd® belts. See your Continental ContiTech Sales Representative or your PTP industrial distributor for more information on the tension gauges listed on this page.

Belt Strand Tension (lb.)

Belt Type	0-100 RPM		101-1000 RPM		1000-Up RPM		Belt Weight (kg/m)
	New Belt	Used Belt	New Belt	Used Belt	New Belt	Used Belt	
SilentSync®							
Yellow	224	160	176	112	128	96	0.073
White	449	305	353	241	273	177	0.147
Purple	897	625	689	481	545	369	0.293
Blue	817	561	657	449	561	385	0.261
Green	1210	842	986	682	842	586	0.392
Orange	1618	1122	1314	914	1122	786	0.523
Red	2436	1700	1956	1364	1700	1172	0.784
Falcon Pd®							
8GTR 12	370	258	210	146	130	98	0.056
8GTR 21	648	456	376	264	232	168	0.093
8GTR 36	1111	775	631	439	391	295	0.167
8GTR 62	1913	1337	1081	761	681	505	0.288
14GTR 20	571	427	459	331	411	299	0.158
14GTR 37	1052	796	844	620	764	556	0.292
14GTR 68	1939	1459	1555	1123	1395	1011	0.537
14GTR 90	2570	1930	2074	1498	1850	1354	0.711
14GTR 125	3578	2666	2874	2074	2570	1866	0.987
Blackhawk Pd®							
8MBH12	179	131	131	99	99	67	0.057
8MBH 22	345	249	233	169	185	137	0.104
8MBH 35	539	379	379	267	299	219	0.165
8MBH 60	928	656	656	464	512	368	0.283
14MBH 20	553	393	409	297	345	249	0.157
14MBH 42	1167	831	863	623	735	527	0.330
14MBH 65	1796	1284	1348	964	1140	804	0.510
14MBH 90	2487	1783	1863	1335	1575	1127	0.706
14MBH 120	3332	2372	2484	1764	2084	1492	0.941
Hawk Pd®							
8M 20	226	162	194	146	178	130	0.118
8M 30	347	251	299	219	283	203	0.176
8M 50	590	430	526	382	478	350	0.289
8M 85	1046	742	918	662	838	598	0.507
14M 40	715	507	571	411	475	347	0.438
14M 55	1069	765	845	605	717	509	0.583
14M 85	1778	1266	1410	1010	1186	850	0.913
14M 115	2486	1782	1974	1414	1654	1174	1.233
14M 170	3827	2739	3059	2179	2579	1843	1.835

TensionRite® Belt Frequency Meter

Part Number: 20287454



Optical Head Replacement

Part Number: 20545642

1. The table values are typically larger than necessary to cover the broad rpm range.
2. For drives where hub loads are critical and high speed drives or other drives with special circumstances, the table values (deflection force, installation tension) should be calculated.
3. Consult the Web site for detailed information on using the frequency-based tension gauges.
4. Continental ContiTech offers three different tension gauges for properly tensioning SilentSync® Hawk Pd® or Blackhawk Pd® belts. See your Continental ContiTech Sales Representative or your PTP industrial distributor for more information on the tension gauges listed on this page.

Technical Information

Drive alignment

Synchronous belts are very sensitive to misalignment. The tension carrying member has a high tensile strength and resistance to elongation, resulting in a very stable belt product. Any misalignment will lead to inconsistent belt wear, uneven load distribution and premature tensile failure. In general, synchronous drives should not be used where misalignment is a problem. Misalignment should be limited to 1/4 degree or 1/16 inch per foot of center distance.

Figure A

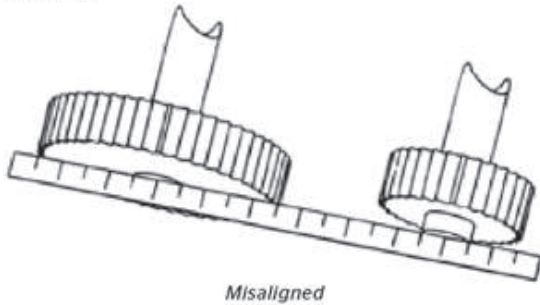

Any degree of misalignment will reduce belt life and cause edge wear. Therefore, a straightedge should be used to check proper alignment verifying that sprockets and shafts are parallel, as in Figure C.

Figure C

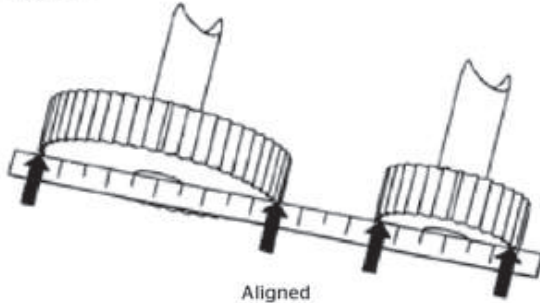

Misalignment, at times, may cause tracking problems. Although some tracking is normal and will not affect belt performance, it may be caused by poorly aligned sprockets. Flanges may control a tracking problem. Considering a two-sprocket drive, belt contact on a single flange is acceptable. Belt contact with the opposite flanges of two sprockets should be avoided.

With parallel shafts, misalignment occurs when there is an offset between the sprocket faces as in Figure A. Misalignment also occurs when the shafts are not parallel as in Figure B.

Figure B

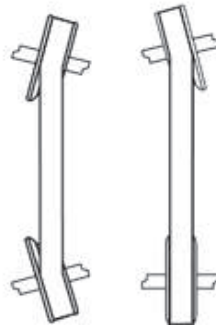

Correct alignment

A straightedge should touch the sprocket at the four points indicated. Both front and back alignments should be checked.

Laser alignment tool

Continental ContiTech Laser Alignment Tool provides an alternative to checking alignment with a straightedge. Each laser alignment tool comes with a rugged carrying case and detailed instructions to get you started with the quickest, easiest and most versatile alignment tool on the market today.

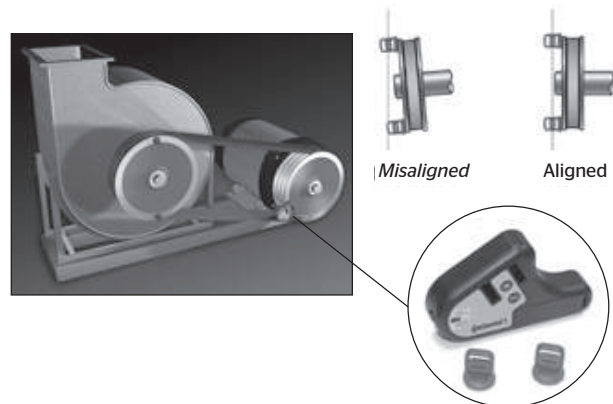

Misalignment can also be attributed to the improper installation of a bushing or loose drive framework. Refer to sprocket manufacture guidelines for proper bushing installation. Secure motor and framework to eliminate vibration on center-to-center fluctuations.

Technical Information

V-belt causes of premature failure

Possible Causes	Problem								
	Cut Thru on Top (Joined Belts)	Mismatched Belts at Installation	Belts too Short at Installation	Belts too Long at Installation	Excessive Vibration	Excessive Stretch	Belt Squeal	Hardening & Premature Cracking	Belts Turn Over
Possible Causes									
Excessive Oil									
Exposure to Elements									
Pried Over Sheaves									
Contact with Obstruction									
Insufficient Tension									
Stalled Drive Sheaves									
Constant Slippage									
Rough Sheaves									
Substandard Sheaves									
Excessive Tension									
Shock Load									
Foreign Material									
Excessive Dust									
Drive Misalignment									
Worn Sheaves									
Excessive Vibration									
High Ambient Temperature									
Damaged Tensile Member									
Incorrect Belts									
Incorrect Drive Set-Up									
Insufficient Take-Up									
Improper Matching									
Mixed Old and New Belts									
Non-Parallel Shafts									
Different Manufacturers									
Belt/Pulley, Incompatible									
Corrective Action									
Lubricate properly									
Clean sheaves and belt									
Replace belts									
Provide protection									
Install properly									
Check for belt length									
Remove obstruction									
Tension properly									
Free sheaves									
Replace sheaves									
File smooth									
Redesign drive									
Operate properly									
Align drive									
Provide ventilation									
Check for proper belt									
Check machinery									
Use only new belts									
Use single source									

continued on page 161

Technical Information

V-belt causes of premature failure

Problem (continued)

	Broken Belts	Side Split	Ply Separation	Uneven Envelope Wear	Envelope Wear	Spin Burn	Gouges	Weathering or "Craze" Cracks	Loose Cover and Swell
Possible Causes									
Excessive Oil									
Exposure to Elements									
Pried Over Sheaves									
Contact with Obstruction									
Insufficient Tension									
Stalled Drive Sheaves									
Constant Slippage									
Rough Sheaves									
Substandard Sheaves									
Excessive Tension									
Shock Load									
Foreign Material									
Excessive Dust									
Drive Misalignment									
Worn Sheaves									
Excessive Vibration									
High Ambient Temperature									
Damaged Tensile Member									
Incorrect Belts									
Incorrect Drive Set-Up									
Insufficient Take-Up									
Improper Matching									
Mixed Old and New Belts									
Non-Parallel Shafts									
Different Manufacturers									
Belt/Pulley, Incompatible									
Corrective Action									
Lubricate properly									
Clean sheaves and belt									
Replace belts									
Provide protection									
Install properly									
Check for belt length									
Remove obstruction									
Tension properly									
Free sheaves									
Replace sheaves									
File smooth									
Redesign drive									
Operate properly									
Align drive									
Provide ventilation									
Check for proper belt									
Check machinery									
Use only new belts									
Use single source									

Technical Information

Synchronous belt causes of premature failure

Types of Failure

Possible Cause of Failure	Excessive Edge Wear	Excessive Tooth Wear	Uneven Tooth Wear	Apparent Belt Stretch	Cracks in Backing	Tooth Shear	Tensile Failure	Excessive Drive Noise	Tooth Skipping (Ratcheting)	Belt Tracking	Excessive Sprocket Wear	Excessive Drive Vibration
Belt Hitting Obstruction	Primary Cause	Could Cause But Not Likely	Possible Cause					Could Cause But Not Likely				Could Cause But Not Likely
Excessive Load		Possible Cause				Primary Cause	Primary Cause					
Belt Overtensioned		Could Cause But Not Likely					Possible Cause				Could Cause But Not Likely	Could Cause But Not Likely
Belt Undertensioned		Primary Cause	Possible Cause	Could Cause But Not Likely					Primary Cause			Could Cause But Not Likely
Rough or Damaged Sprocket		Possible Cause	Possible Cause									Could Cause But Not Likely
Misalignment		Primary Cause	Primary Cause			Possible Cause	Primary Cause			Primary Cause	Could Cause But Not Likely	
Worn Sprocket		Possible Cause	Possible Cause			Could Cause But Not Likely			Could Cause But Not Likely			Could Cause But Not Likely
Sprocket Out of Tolerance		Could Cause But Not Likely	Could Cause But Not Likely			Could Cause But Not Likely			Could Cause But Not Likely	Could Cause But Not Likely	Could Cause But Not Likely	Could Cause But Not Likely
Soft Sprocket Material											Primary Cause	
Debris in Sprocket or Drive		Possible Cause	Could Cause But Not Likely			Could Cause But Not Likely	Possible Cause		Possible Cause	Possible Cause	Primary Cause	Possible Cause
Center Distance Changed		Could Cause But Not Likely		Primary Cause				Could Cause But Not Likely	Possible Cause			Primary Cause
Weak Drive Structure		Could Cause But Not Likely		Primary Cause				Could Cause But Not Likely	Possible Cause	Possible Cause		Primary Cause
Excessive Low Temperature					Primary Cause	Could Cause But Not Likely						
Excessive High Temperature					Primary Cause	Could Cause But Not Likely						Could Cause But Not Likely
Exposure to Oil, Solvents, Chemicals					Possible Cause	Could Cause But Not Likely	Could Cause But Not Likely		Could Cause But Not Likely		Could Cause But Not Likely	
Sprocket Diameter Sub Minimum				Could Cause But Not Likely	Primary Cause		Possible Cause					
Back Side Idler					Possible Cause							
Shock Loading					Possible Cause	Primary Cause	Possible Cause		Possible Cause			
Less than 6 Teeth in Mesh		Could Cause But Not Likely	Could Cause But Not Likely			Possible Cause						
Excessive Sprocket Runout							Could Cause But Not Likely					Possible Cause
Damage Due to Handling							Primary Cause				Could Cause But Not Likely	
Vibrating Bearings/ Mountings												Possible Cause
Center Distance Greater than 8x Small Sprocket Diameter										Possible Cause		
Sprocket Not Properly Balanced								Possible Cause				Primary Cause
Belt/Sprocket Incompatible		Possible Cause				Possible Cause		Possible Cause			Possible Cause	Possible Cause

continued on page 163

Legend

- Primary Cause
- Possible Cause
- Could Cause But Not Likely

Technical Information

Synchronous belt causes of premature failure

Types of Failure (continued)

	Excessive Edge Wear	Excessive Tooth Wear	Uneven Tooth Wear	Apparent Belt Stretch	Cracks in Backing	Tooth Shear	Tensile Failure	Excessive Drive Noise	Tooth Skipping (Ratcheting)	Belt Tracking	Excessive Sprocket Wear	Excessive Drive Vibration
Corrective Action												
Banded	Remove obstruction or use idler to reroute belt	Primary Cause	Possible Cause					Possible Cause				Possible Cause
	Redesign drive					Primary Cause	Primary Cause					
	Use tensioning gauge to set proper tension		Possible Cause				Possible Cause				Possible Cause	Possible Cause
V-Belt	Use tensioning gauge to set proper tension		Primary Cause	Possible Cause	Possible Cause			Possible Cause	Primary Cause			Possible Cause
	Replace sprocket		Possible Cause									Possible Cause
	Align shafts and sprockets		Primary Cause	Primary Cause		Possible Cause	Primary Cause			Primary Cause	Possible Cause	
Bushing Hardware	Replace sprocket		Possible Cause			Possible Cause			Possible Cause			Possible Cause
	Replace sprocket, never attempt to remachine		Possible Cause	Possible Cause		Possible Cause			Possible Cause	Possible Cause	Possible Cause	Possible Cause
	Use harder sprocket material			Possible Cause							Primary Cause	Possible Cause
	Shield drive		Possible Cause			Possible Cause	Possible Cause		Possible Cause	Possible Cause	Primary Cause	Possible Cause
	Check lock down bolts on motors and shafts		Possible Cause		Primary Cause				Possible Cause			
	Reinforce drive structure		Possible Cause		Primary Cause				Possible Cause	Possible Cause		Primary Cause
	Moderate temperature, especially at start-up					Primary Cause	Possible Cause					Possible Cause
Specialty	Moderate temperature, shield drive				Possible Cause	Possible Cause						Possible Cause
	Shield drive, eliminate chemicals				Possible Cause	Possible Cause	Possible Cause		Possible Cause		Possible Cause	
	Redesign drive to increased sprocket diameters				Possible Cause	Primary Cause	Possible Cause					
	Redesign to reduce wrap on backside idler					Possible Cause						
Automotive & Truck	Eliminate shock loading or redesign drive to handle it				Possible Cause	Primary Cause	Possible Cause		Possible Cause			
	Increase wrap on sprocket		Possible Cause	Possible Cause		Possible Cause						
	Replace sprocket						Possible Cause					Possible Cause
	Replace product, do not crimp belt or drop sprockets						Primary Cause				Possible Cause	
	Replace bearings or reinforce mountings											Possible Cause
	Alignment is critical									Possible Cause		
	Check sprocket balance								Possible Cause			Primary Cause
Check for proper belt		Possible Cause						Possible Cause		Possible Cause	Possible Cause	

Legend
 Primary Cause
 Possible Cause
 Could Cause But Not Likely

Mandrel Quantity Requirements

For special length or made-to-order belts*

The following quantities are for approximate reference only; mandrel tool sizes and availability at time of order may not be available. Please contact factory for verification.

HY-T® Belts

	Cross Section	Under 123 in.	124 - 300 in.	301 in. & Up
	A	68	135	-
	B*	50	100	50
>B38=>50 Pcs	C	42	64	32
<B38=>53 Pcs	D	25	46	24
	E	-	42	21

HY-T® Wedge/Wedge TLP Belts Envelope

Cross Section	Up to 90 in.	90 - 140 in.	150 in. & Up
3V, 3VT	117, 129	84, 93	-
5V, 5VT	68, 77	50, 57	95, 93
Cross Section	Up to 140 in.	150 - 300 in.	301 in. & Up
8V, 8VT	31	61	31

HY-T® Wedge Belts Cut-Edge

Cross Section	Up to 120 in.	120 - 140 in.	141 - 300 in.	301 in. & Up
3VX	98	98	176	-
5VX	63	63	100	50

Torque Team® Belting

(Including Torque-Team Plus® and Laminated)

Cross Section	Cut-Edge	Envelope		
	25 - 118 in.	116 - 123 in.	124 - 300 in.	301 in. & Up
3VX	95			
5VX	54			
8V	-			
AX	60			
BX	50			
CX	36			
DX	29			
3V		88	176	-
5V		50	100	50
8V		32	64	32
A		68	135	-
B		50	100	50
C		42	64	32
D		25	46	24

FHP Envelope

Cross Section	Cut-Edge Length	Envelope			
	12 - 112 in.	Under 28 in.	28 in. & Over	Under 38 in.	38 in. & Over
2L**	-				
3L	104				
4L		75	75		
5L				54	54

**2Ls unavailable in envelope construction.

*Nonstock Belts: Orders for nonstock or made-to-order belts are available in multiple mandrel size quantities. Please check factory for availability of equipment and/or availability for the desired construction.

Mandrel Quantity Requirements

For special length or made-to-order belts*

The following quantities are for approximate reference only; mandrel tool sizes and availability at time of order may not be available. Please contact factory for verification.

FHP Cut-Edge

Cross Section	12 - 116 in. Length
2L	152
3L	98
4L	79
5L	63

Torque-Flex® Belts

Cross Section	Under 116 in.	116 - 132 in.	124 - 300 in.	301 in. & Up
AX	73	73	135	-
BX	57	57	100	50
CX	42	42	64	32
DX	-	24	48	24

Positive Drive Belting*

Under 120 in.	Profile	120 in. & Up
Standard Positive Drive		
26	MXL	-
26	XL	-
26	L	-
26	H	13
26	XH	13
26	XXH	13
Dual Positive Drive		
26	XL	-
26	L	13
26	H	13
26	XH	13
Hawk Pd® and Blackhawk Pd		
26	5M	-
26	8M	13
26	14M	13
26	20M	13
Super Torque Positive Drive (STPD)		
28	3M	-
28	4.5M	-
28	5M	-
27	8M	14
26	14M	13

Variable Speed Belts

Any Length
38 in. wide mandrel*

*In. indicate the total top width mandrel yield (e.g., divide belt top width into yield for total number of belts per mandrel).

Hex Belts

Cross Section	0 - 123 in.	124 - 300 in.	Over 300 in.
AA	67	118	-
BB	49	94	47
CC	34	60	30

Cut-Edge Automotive Belts

Width	Top Length (in.)	12 - 116 in.
	13/32	98
	15/32	87
	17/32	76
	22/32	60
	24/32	54
	28/32	45
	32/32	39

SilentSync® and Falcon Pd®: Contact customer service for correct quantities.
*In. indicate the total top width mandrel yield (e.g., divide belt top width into yield for total number of belts per mandrel).

Dry Can Belts

240 - 300 in.	300 in. & Over
60	29

Neothane® Belts

Cross Section	12 - 118 in. Length
5MR	200
7MR	124
11MR	85

Poly-V® Belts (Cut-Edge Only)

Cross Section	12 - 118 in. Length
"J" Section	10 in. - 120 in. = 400 ribs
"L" Section	25 in. - 120 in. = 200 ribs
"M" Section	50 in. - 118 in. = 100 ribs
"K" Section	12 in. - 120 in. = 265 ribs

Belt Storage

General guidelines

The storage of power transmission belts is of interest to users and distributors as well as manufacturers. Under favorable storage conditions, good quality belts retain their initial serviceability and dimensions. Conversely, unfavorable conditions can adversely affect performance and cause dimensional change. Good storage facilities and practices will allow the user to achieve the most value from belt products.

Power transmission belts should be stored in a cool and dry environment with no direct sunlight. When stacked on shelves, the stacks should be small enough to avoid excess weight on the bottom belts which may cause distortion. When stored in containers, the container size and contents should be sufficiently limited to avoid distortion, particularly to those belts at the bottom of the container.

Some things to avoid

Do not store belts on floors unless a suitable container is provided. They may be susceptible to water leaks or moisture or otherwise damaged due to traffic.

Do not store belts near windows which may permit exposure to sunlight or moisture. Do not store belts near radiators, or heaters or in the airflow from heating devices.

Do not store belts in the vicinity of transformers, electric motors or other electrical devices that may generate ozone. Also avoid areas where evaporating solvents or other chemicals are present in the atmosphere.

Do not store belts in a configuration that would result in bend diameters less than the minimum recommended sheave or pulley diameter for normal bends and not less than 1.3 times the minimum recommended diameters for reverse bends. (Refer to appropriate ARPM-MPTA-RAC Standards for minimum recommended diameters.)

Belt Storage

Methods of storage

V-belts

A common method of storing belts is to hang them on pegs or pin racks. Very long belts stored this way should use sufficiently large pins or crescent-shaped "saddles" to prevent their weight from causing distortion. Long V-belts may be "coiled" in loops for easy distortion-free storage. The following table is a guide to the maximum number of coils for extended storage time:

V-Belts

Belt Cross Section	Belt Length (in.)	Belt Length (mm)	# of Coils*	# of Loops
3L, 4L, A, AX, AA	Under 60	Under 1500	0	1
5L, B, BX, 3V	60 up to 120	1500 up to 3000	1	3
9R, 13R, 13C, 13CX, 13D	120 up to 180	3000 up to 4600	2	5
16R, 16C, 16CX, 9N	180 and over	4600 and over	3	7
BB, C, CX	Under 75	Under 1900	0	1
5V	75 up to 144	1900 up to 3700	1	3
16D, 22C, 22CX	144 up to 240	3700 up to 6000	2	5
15N	240 and over	6000 and over	3	7
	Under 120	Under 3000	0	1
	120 up to 240	3000 up to 6100	1	3
CC, D	240 up to 330	6100 up to 8400	2	5
22D, 32C	330 up to 420	8400 up to 10,600	3	7
	420 and over	10,600 and over	4	9
	Under 180	Under 4600	0	1
	80 up to 270	4600 up to 6900	1	3
8V (25N)	270 up to 390	6900 up to 9900	2	5
	390 up to 480	9900 up to 12,200	3	7
	480 and over	12,200 and over	4	9

*One coil results in three loops, two coils result in five loops, etc.

Belt Storage

Methods of storage

Joined V-belts, Synchronous belts, V-ribbed belts

Like V-belts, these belts may be stored on pins or saddles with precautions taken to avoid distortion. However, belts of these types, up to approximately 120 inches (3,000mm), are normally shipped in “nested” configuration and it is recommended that the belts be stored in this manner as well. Nests are formed by laying a belt on its side on a flat surface and placing as many belts inside the first belt as possible without undue force. When the nests are tight and stacked with each rotated 180° from the one below, they may be stacked without damage.

Belts of these types over approximately 120 inches (3,000mm), may be “rolled up” and tied for shipment. These rolls may be stacked for easy storage. Care should be taken to avoid small radii, which could damage the belts.

Variable speed belts

A common method of storing belts is to hang them on pegs or Variable Speed belts are more sensitive to distortion than most other belts and it is not recommended that these belts be hung from pins or racks. They should be stored on shelves. A common method for packaging for shipment is the use of a “sleeve” slipped over the belt. Variable Speed belts should be stored in these sleeves and may conveniently be stacked on shelves with the aid of the sleeves.

Effects of storage

The quality of belts has not been found to change significantly within seven years of proper storage at temperatures less than 85°F (30°C) and relative humidity below 70%. Also there must be no exposure to direct sunlight.

If the storage temperature is increased beyond 85°F (30°C), then the storage limit for normal service expectancy should be reduced. From a base of 7 years at 85°F (30°C), the storage limit should be reduced by one-half for each 15°F (8°C) increase in temperature. Under no circumstances should belts be exposed to storage temperatures above 115°F (46°C).

With a significant increase in humidity, it is possible for fungus or mildew to form on stored belts. This does not appear to cause serious belt damage, but should be avoided if possible.

Equipment using belts is sometimes stored for prolonged periods (six months or more) before it is put in service or during other periods when it is idle. It is recommended that the tension of the belts be relaxed during such period and that equipment storage conditions should be consistent with the guidelines for belt storage. If this is not possible, the belts should be removed and stored separately.

Source: ARPM IP-3-4, 2007

Continental ContiTech Matchmaker® System

The ARPM Engineering Standards IP-20 & IP-22 sets up limits for matching Classical and Wedge V-belts having polyester cord based on their lengths and cross-sections. These standards have been developed to ensure that belts that meet the ARPM tolerances will run together on multiple-belt drives and effectively share the load that is being transmitted.

V-Belt Permissible Deviation From Nominal Length - Envelope Narrow Profile (Industry Standard)

Product Length (in.)	Range
0 to 50 - 63/64	15mm (.5905 in.)
51 to 80 - 63/64	20mm (.7874 in.)
81 to 100 - 63/64	25mm (.9842 in.)
101 to 140 - 63/64	30mm (1.181 in.)
141 to 300 - 63/64	40mm (1.575 in.)
301 to 400 - 63/64	50mm (1.968 in.)
401 to 500	61mm (2.400 in.)

Source: ARPM 1P-22, 2007
Engineering Standard "Envelope Narrow V-Belts and Sheaves"

Many Continental ContiTech branded V-belts are produced to meet these standards under the Matchmaker® Matching System. Multiple V-belts will still have different lengths under this system; however, the elongation of the polyester reinforced V-belts will allow the belt lengths to normalize once the belts are tensioned. The Matchmaker® System only applies to V-belts with polyester cord; V-belts with aramid cord do not fall into this program. Sets of multiple aramid reinforced V-belts have to be specially ordered to ensure they are within an acceptable length range to each other or they can be ordered as one banded HY-T® Torque Team Plus® belt.

As an example, a 5V710 belt has a Matchmaker® matching limit of 0.30 inches. This means a 5V710 that measures 71.150 inches is considered matched to one that measures 70.850 inches because the difference in belt length between the two is 71.150 inches - 70.850 inches = 0.30 inches, which is within the 0.30 inches matching limit that is called out for in the Matchmaker® System.

Matchmaker® Belts

Inventory	Classical Lengths (in.)		Wedge Lengths (in.)	
Wedge TLP™ (3VT, 5VT, 8VT)	0-60	0.15	0-63	0.15
HY-T® Wedge (3VX, 3V, 5VX, 5V & 8V)	61-144	0.30	64-150	0.30
HY-T® Plus (A, B, C & D)	145-240	0.45	151-250	0.45
Torque-Flex® (AX, BX & CX)	241-360	0.60	251-375	0.60
HY-T® Torque Team® (HY-T & HY-T Wedge)	361-480	0.75	376 & longer	0.75
Torque Team® Laminated	481 & longer	0.90		

Meets ARPM Engineering Standards IP-22 for Narrow V-Belts, 2007

As a final note, the best way to optimize the Matchmaker® program is to utilize the "first in-first out" method of inventory control. Every V-belt manufacturer that produces polyester-corded belts bases their matching principles on the assumption that their inventory is constantly turning over. This is because an inherent property of polyester is that it will shrink over time. Thus, a belt built two years ago will not measure the same as it did when it was originally produced. How much and how fast the polyester shrinks is largely dependent on the environmental conditions that the belt is exposed to during storage. As it is difficult to easily monitor the environment of certain storage spaces, it becomes apparent why it is important to make certain that the oldest inventory is the first to be used. With these procedures in place, the Matchmaker® System will continue to serve your multiple-belt drive needs.

Oil and Chemical Resistance of Power Transmission Belts

In general, the presence of oil or chemicals in contact with any belt drive system can materially affect the life span and operational characteristics of the system. The concentration of the chemical or oil involved, length and type of exposure, choice of belt type used and environmental conditions, such as heat and humidity, all contribute to the rate and degree of effect on the performance and deterioration.

Two effects may be noted when belts are exposed to oil and/or chemicals. The most obvious is a swelling or increase in dimensions of the cross-section so that they no longer fit the pulley or sheave groove properly. Less apparent at casual observation, is the deterioration of the original physical properties, which includes adhesion between the belt components. If the degree of swelling and/or loss of physical properties is significant, the life of the belt will be substantially shortened.

The above effects may be brought about by a large variety of chemicals, notably oils, acids and solvents.

No one synthetic rubber is resistant to all of these. Some compounds may be excellent for one chemical, but poor for another and only adequate for still another.

Because of this, all Continental ContiTech stock belts are constructed to be reasonably oil and chemical resistant. The nature of the compounds and/or belt construction may minimize swelling and deterioration. Occasional splattering by oils and greases does not usually adversely affect standard belts. The automotive fan belt is a typical example. In addition,

there are a great number of chemicals, such as gasoline, which swell rubber or extract ingredients from the belt's rubber compounds. These may cause embrittlement, cracking or swelling of the belt, which results in deterioration of performance.

If the drive is subjected to the accumulation of a considerable amount of oil and grease on the belt, it may preclude the use of a V-belt or a V-ribbed belt. Synchronous belts are not substantially affected by the loss of friction coefficient and may be capable of limited operation under these conditions.

As can be seen from the above, there are many variables; however, the following general guidelines might be of use in selecting a belt drive system subjected to a chemical environment.

1. Prevent the accumulation of contaminants.
2. If the belts are to be subjected to only an occasional contamination contact, a standard construction V- or synchronous belt can be used.
3. If the belts are expected to give long, trouble-free operation on an industrial drive and they are in contact with oil or exposed to an atmosphere laden with chemicals or solvents, consult the manufacturer for recommendations.

Source: ARPM 1P-3-2, 1999

Static Conductive Belts

Under certain operating conditions, a belt drive may generate static electricity. This poses a risk with belt drives used in the presence of potentially explosive gases, liquids, powders, dusts, etc., where the possibility of static sparks must be kept to a minimum. Static discharge can also interfere with sensitive electronic circuitry, radios and controls. Belts can be manufactured with materials that facilitate a grounding path for static electricity. It is common in the industry to refer to such belts as "static conductive." It is important to note that all components of the drive must be conductive to establish a clear grounding path to dissipate any static charge.

For non-synchronous (friction drive) power transmission belting, Continental ContiTech references International Standards Organization standard ISO-1813, which describes a test procedure and fixture where electrodes are machined to match the specific belt cross section profile. The maximum allowable resistance, measured with an applied potential of 500 volts, is calculated from the formula shown below and tabulated in the standard.

For synchronous power transmission belting, the reference document is ISO standard 9563, which describes a test procedure and fixture specific to synchronous belting, where the electrodes are machined to match the specific tooth profile of the belt. The maximum allowable resistance, measured with an applied potential of 500 volts, is calculated as follows:

$$R = \frac{6 \times 10^5 L}{w}$$

Where **R** = resistance in ohms
L = distance between electrodes
w = width of the belt

Drive conditions and service variables in combination with time in operation can result in a loss of static conductivity. It is recommended that a conductivity check be added to drive preventative maintenance programs where belt static conductivity is a requirement.



Product Accessories & Sales Aids

Drive Maintenance Materials

Items	SAP #	Availability
TensionRite® Belt Frequency Meter	20287454	Customer Service
TensionRite® Optical Head Replacement	20545642	Customer Service
Laser Alignment Tool	20245089	Customer Service
Laser Alignment Tool Replacement Magnet	20304774	Customer Service
TensionRite® Large Tension Tester (instructions included)	20083777	Customer Service
TensionRite® Small Tension Tester (instructions included)	20044882	Customer Service
Belt Drive Stickers / 10 per pack	20781859	GBS

General Sales Materials

Items	SAP #	Availability/List Price
PTP Full Line Product Catalog	20781857	www.contitech.us or GBS
Falcon Pd® Brochure	20781836	www.contitech.us or GBS
SilentSync® Brochure	20781835	www.contitech.us or GBS
Wedge TLP™ Brochure	20781837	www.contitech.us or GBS
Acculinear® Brochure	20781839	www.contitech.us or GBS
ELATECH® Polyurethane Belt Brochure	20781840	www.contitech.us or GBS
E's of Efficiency Brochure	20781831	www.contitech.us or GBS
Metric Belts Sales Flyer	20781838	www.contitech.us or GBS
Laser Alignment Tool Flyer	20781852	www.contitech.us or GBS
TensionRite® Belt Frequency Meter Flyer	20781852	www.contitech.us or GBS
Full Size TensionRite® Belt Frequency Meter User's Manual	20781856	www.contitech.us or GBS
TensionRite® Belt Freq Meter Tensioning Tables	20781853	www.contitech.us or GBS
MaximizerPro™ Flyer	20781849	www.contitech.us or GBS

Product Accessories & Sales Aids

Application

Items	SAP #	Availability/List Price
Cross-Reference Materials		
Industrial Belt Wall Chart Product Reference - 11 x 17 in.	20781847	GBS
Industrial Belt Wall Chart Product Reference - poster size	20781848	GBS
Car & Light Truck Application Guide (current to 1994)	20035740	Customer Service
Car & Light Truck Application Guide (1993 and prior)	20049146	Customer Service
Medium to Heavy-Duty Truck Application Guide (current to 1990)	20049138	Customer Service
Software		
MaximizerPro™ Drive Analysis Software Program		www.contitech.us or GBS
MaximizerPro™ Drive Data Gathering Form		www.contitech.us or GBS

Training

Items	SAP #	Availability/List Price
Product Specific		
Installation, Maintenance & Trouble Shooting Guide	20781858	www.contitech.us or GBS
Installation, Maintenance & Trouble Shooting Pre-Packaged Seminar Kit		GBS
Drive Change SM Training Flyer		www.contitech.us

Product Accessories & Sales Aids

Miscellaneous Sales Supplies & Tools

Items	SAP #	Availability
SilentSync® Sprocket Demo Kit (limit 1 each per order)	20039454	GBS
Straight Edge Pulley / Sprocket Alignment Tool (limit 2 each per order)	20039449	Customer Service
"V" Profile Sheave Gauge	20044915	Customer Service
Automotive & FHP Belt Measuring Gauge	20035727	Customer Service
Small Blank Sleeves - PB616-6	20073740	Customer Service
Large Blank Sleeves - PB617-6	22073741	Customer Service
3 ft. Wood Wall Racks (20 boards per box)	20073299	Customer Service
6 in. Metal Hooks (250 hooks per box)	20073283	Customer Service
12 in. Metal Hooks (250 hooks per box)	20073284	Customer Service

Overview

Synchronous

Banded

V-Belt

Bushing Hardware

Specialty

Automotive & Truck

General Information