

Catálogo de accesorios Náuticos



Trolling
Motors



Instruments



Electrical



Lighting



Anchor
& Dock



Safety



Steering,
Controls



Pumps



Fuel
System



Seating &
Pedestals



Trailerling



Tops &
Covers



2021

Parte 1

El Navegante

www.repuestoselnavegante.com



- Trolling Motors
- Instruments
- Electrical
- Lighting
- Anchor & Dock
- Safety
- Steering, Controls
- Pumps
- Fuel System
- Seating & Pedestals
- Trailer
- Tops & Covers
- Perform.
- Propellers
- Engine & Care
- Cleaning & Care
- Paint & Paint Acc.
- Fun & Flotation
- Topside Acc.
- Cockpit & Deck
- Hardware, Fasteners
- Camouflage
- Misc.
- Comm.

Bienvenidos a Repuestos El Navegante.

Aquí podrás encontrar mas de **35.000** productos de diferentes fabricantes, con una gran variedad de accesorios y componentes para tu embarcación, contamos con mas de 20 años de experiencia en el sector náutico, no dudes en contactarnos para aclarar cualquier duda que tengas, prestamos asesoría técnica lo que es un valor agregado, y te dará tranquilidad a la hora de tomar una decisión de compra.

Nota Importante:

Debido a las restricciones causadas por el Covid 19, y otros problemas a nivel Mundial muchas empresas se vieron afectadas debido a la falta de materia prima, por este motivo tanto los precios como las fechas de entrega sufrieron cambios en gran cantidad de productos, comuníquese con nosotros a través del correo: repuestoselnavegante@gmail.com y solicite su presupuesto sin compromiso, también puede comunicarse vía Telegram o WhatsApp escaneando los códigos QR.

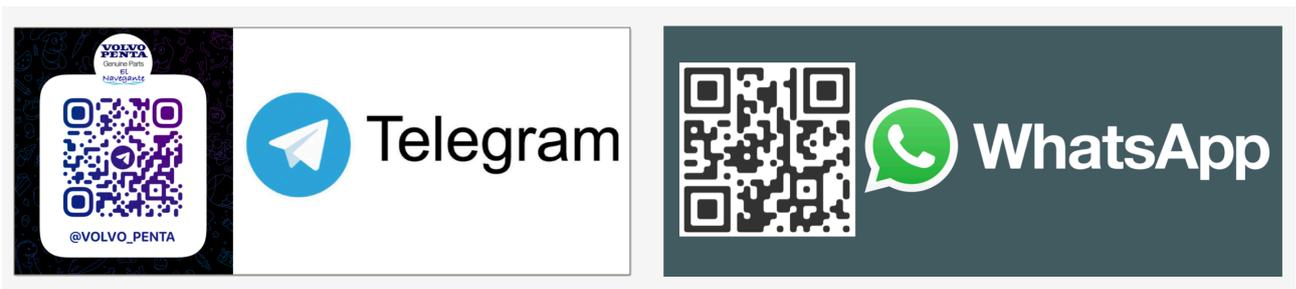

Los productos aquí publicados se encuentran en varias partes del mundo, pero la mayoría se encuentran en Estados Unidos y Europa, por lo que estos precios no incluyen gastos de envío.

También puede consultar en nuestra pagina www.repuestoselnavegante.com nuestros términos y condiciones antes de efectuar la compra, ahí podrá ver también nuestra política de devoluciones.

Los productos pueden ser entregados en un currier de su confianza.

En nuestra pagina podrá encontrar mas de **3.500** productos para entrega inmediata.

Nos especializamos en repuestos Volvo Penta, Cummings, Yanmar, Caterpillar, Mercruiser.

Ofrecemos repuestos para Generadores Onan, Kohler, Westerbeke, Fisher Panda y Northern Lights.

Marpac Stainless Steel Drain Plugs



- Corrosion resistant stainless steel handle.
- Neoprene body for a leakproof, nonslip seal.

Order No.	Description	Fits Drain Tube:	List Price	
7-0563	Snap Drain Plug	1"	\$3.69	G0-7420000
7-0563S	Snap Drain Plug (Bucket of 50)	1"	\$134.19	G0-1998000
7-0565	Snap Drain Plug	1-1/4"	\$5.29	G0-4530000
7-0564	Twist Drain Plug	1"	\$2.99	G0-0020000
7-0564S	Twist Drain Plug (Bucket of 50)	1"	\$120.69	G0-6808000
7-0567	Twist Drain Plug	1-1/4"	\$5.29	G0-4530000

Moeller Turn-Tite® Brass Drain Plugs



- Corrosion resistant construction.
- Designed only for mounting from the inside of the transom.
- Fully adjustable, simply turn the T-handle clockwise to create a waterproof construction.

Order No.	Mfg. No. / Description	List Price	
486872	(020899-20) 1" Brass Fishbowl of 20	\$98.99	H0-9395000
486868	(020899-50) 1" Brass Bucket of 50	\$152.79	F0-5960100
486820	(020883-001) 1-1/4" Brass Sold Bulk	\$3.69	H0-1220000

Boater Sports Aluminum Snap Type Drain Plug



- Drain plugs comes with a rubber expansion which offers a smooth, tight seal.
- Aluminum.
- Sold 2 per pack.

Order No.	Mfg. No.	List Price	
1-54824	(54824) Fits 1" Drain Tube	\$4.49	H0-9620000

Moeller Deck and Baitwell Plugs



- A neoprene body, provide a leakproof, nonslip seal featuring stainless steel plates and adjustable brass cam snaps.

Order No.	Mfg. No. / Description	List Price	
487000	(053063-10) 3/8" ID	\$5.19	G0-8430000
4810097	(51004-10) 9/16" ID	\$3.79	G0-4520000
4810099	(51008-10) 13/16" ID	\$4.29	G0-7820000
4810100	(51010-10) 31/32" ID	\$4.69	G0-4130000

Marpac Brass Drain Plugs



- Corrosion resistant brass handle.
- Neoprene body for a leakproof, nonslip seal.
- Fits 1" drain tube.

Order No.	Description	List Price	
7-0093	Snap Drain Plug	\$3.19	G0-4120000
7-0093S	Snap Drain Plug (Bucket of 50)	\$125.19	G0-8838000
7-0094	Twist Drain Plug	\$2.89	G0-4910000
7-0094S	Twist Drain Plug (Bucket of 50)	\$114.89	G0-8967000

Moeller Snap-Tite® Drain Plugs



- Corrosion resistant construction.
- Designed only for mounting from the inside of the transom.
- These plugs utilize a smooth operating mechanism to provide the tightest possible seal.

Order No.	Mfg. No. / Description	List Price	
486945	(029000-50) 1" Brass Bucket of 50	\$197.49	F0-4283100
486969	(029070-10) 1" Aluminum Sold Each	\$4.89	G0-8230000
486957	(029055-001) 1-1/4" Brass Sold Bulk	\$4.49	F0-4130000

Marpac Baitwell Plugs with Brass Handle

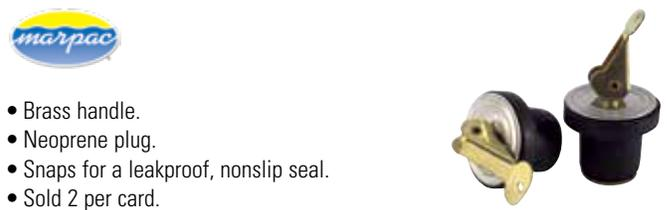

- Brass handle.
- Neoprene plug.
- Snaps for a leakproof, nonslip seal.
- Sold 2 per card.

Order No.	Description	List Price	
7-0570	1/2" ID	\$3.19	G0-4120000
7-0571	5/8" ID	\$3.49	G0-4320000
7-54858	11/16" ID	\$7.39	G0-5940000
7-0572	3/4" ID	\$3.59	G0-1420000
7-54860	7/8" ID	\$4.79	H0-7820000

Attwood Livewell/Bailer Drain Plug



- Cam-action neoprene plugs snap shut to form stopper for livewells/ baitwells.
- Clockwise turn of the handle tightens plug, lever flips down to lock. Brass snaps and plates.

Order No.	Mfg. No. / Description	List Price	
236050	(7533A1) For 1/2" ID Thru Hull	\$6.79	F0-5740000

- Electronics
- Trolling Motors
- Instruments
- Electrical
- Lighting
- Anchor & Dock
- Safety
- Steering, Controls
- Pumps
- Fuel System
- Seating & Pedestals
- Trailering
- Tops & Covers
- Perform.
- Propellers
- Engine & Care
- Cleaning & Care
- Paint & Paint Acc.
- Fun & Flotation
- Topside Acc.
- Cockpit & Deck
- Hardware, Fasteners
- Camouflage
- Misc.
- Comm.

- Electronics
- Trolling Motors
- Instruments
- Electrical
- Lighting
- Anchor & Dock
- Safety
- Steering, Controls
- Pumps**
- Fuel System
- Seating & Pedestals
- Trailering
- Tops & Covers
- Perform.
- Propellers
- Engine & Care
- Cleaning & Care
- Paint & Paint Acc.
- Fun & Flotation
- Topside Acc.
- Cockpit & Deck
- Hardware, Fasteners
- Camouflage
- Misc.
- Comm.

Moeller Air Chamber Plug



- Designed to seal 5/8" openings in baitwells, livewells or dry boxes.
- Oil and grease resistant.
- Just pop in the black neoprene rubber plug for a secure, tight fit.

Order No.	Mfg. No. / Description	List Price
487199	(090801-10)	\$3.79 HO-7220000

Marpac The "Never Lose It Again Plug" Drain Plug Assembly



- This screw-type drain plug is constructed of black nylon and features an O-ring for positive sealing.
- Fine threads maintain sealing under heavy vibrations.
- Mounts in a 1" diameter hole.
- Ideal for transoms, livewells, water tanks or even ice chests.
- Display packaged.

Order No.	Description	List Price
7-54865	Drain Plug Assembly	\$3.89 GO-1620000

Boater Sports Garboard Drain Plug



- 3/4"
- Heavy duty nylon construction, won't rust.
- No-leak polymer seal.
- Helps to prevent losing another drain plug.
- Installs into 1" hole.

Order No.	Mfg. No. / Description	List Price
1-54867	(54867)	\$3.39 HO-3020000

Marpac Screw-In Drain Plug



- Screw-in design with catch-T stays with boat.
- Tough nylon material with O-ring seal.
- 1-1/2" x 2" flange.
- Fits 1" hole.

Order No.	Description	List Price
7-0368	Black	\$7.39 GO-5940000

T-H Marine Drain Plugs



- This screw-type drain plug is constructed of polypropylene and features an chemically inert O-ring for positive sealing.
- Fits 1" diameter hole with two #8 countersunk stainless steel screws.
- Flange: 1-1/2" x 2".

Order No.	Mfg. No. / Description	List Price
641389	(DP-1-DP) Black	\$8.59 HO-5150000
641391	(DP-2-DP) White	\$9.19 HO-1550000

Moeller Transom Drain Tube with Plug



- Fits flush to boat transom or exterior.
- The plug has a screw-driver slot and rubber O-ring to seal watertight.
- Tough natural nylon will not rot, bend or mildew.
- Fits 1-1/8" ID opening, flange OD 2-3/16".

Order No.	Mfg. No. / Description	List Price
486755	(020303-10)	\$7.69 HO-1640000
4810044	(20304-10) Spare Plug (5 Per Package)	\$8.49 HO-9050000

Flow-Rite Controls Remote Drain Plugs



- With today's high performance hull designs, jack plates and larger outboards, putting a drain plug in or taking one out can be a very unpleasant task.
- The Flow-Rite Remote Drain Plug makes that job as simple as turning a switch.
- No more lying on a wet boat ramp to put in or take out a drain plug.
- Never worry about forgetting your drain plug again!
- Easily open or close your drain plug from your console.
- Easy to install on any fiberglass or aluminum hull with a 1" mounting hole.

Order No.	Mfg. No. / Description	List Price
7000402	(MPA-RDP-008) Cable Length 8'	\$124.99 HO-9947000
7000404	(MPA-RDP-010) Cable Length 10'	\$124.99 HO-9947000

Marpac Garboard Drain Plugs



- Fits 1/2" NPT pipe.
- Flange OD 2".
- Depth 5/8".

Order No.	Description	List Price
7-0352	Stainless Steel	\$23.39
7-0353	Spare Stainless Steel Plug 1 Per Card	\$15.29
7-0322	Cast Bronze	\$6.19
7-0824	Spare Cast Bronze Plug 2 Per Card	\$5.29

Marpac Garboard Plug



- Brass.
- Fits 1" hole.
- 1/2" NPT.

Order No.	Description	List Price
7-54835	Garboard Plug	\$7.79

Marpac Flanged Drain Tube



- Brass.
- Dimensions: 1" x 3".

Order No.	Description	List Price
7-0569	Flanged Drain Tube	\$3.39

Moeller Motorwell Drain Tube



- Concentric rings snap-lock in place for a tight leakproof seal in 1" diameter opening.
- Durable plastic drain for motorwell, livewell or baitwell.
- Will not rot, bend or mildew.
- 3/4" to 2-1/2" long.

Order No.	Mfg. No. / Description	List Price
486743	(020300-10)	\$5.19

Perko Fig. 714 Garboard Drain Plugs



- Cast bronze flange with brass plug.
- 1/2" IPT thread.
- Flange OD 2".
- Uses #8 fasteners.

Order No.	Mfg. No. / Description	List Price
541753	(0714 DP1 PLB)	\$30.79
467628	(28-087) Spare Plug Sold Each Bulk	\$4.29

Moeller Drain Tubes



- Special alloy brass or aluminum tube flanged 90° on one end to function as a drain for transom, motorwell, livewell or baitwell
- Use brass tubes with brass plugs and aluminum tubes with aluminum plugs.
- Wall thickness .035".
- Measurements are OD x length.

ALUMINUM

Order No.	Mfg. No. / Description	List Price
486870	(021002-188D) 1" x 1-7/8"	\$2.59
4810047	(21002-225D) 1" x 2-1/4"	\$2.79
4810048	(21002-300D) 1" x 3"	\$3.59

BRASS

Order No.	Mfg. No. / Description	List Price
486882	(021003-188D) 1" x 1-7/8"	\$4.59
486894	(021003-300D) 1" x 3"	\$6.59
486907	(021253-300D) 1-1/4" x 3"	\$6.79

T-H Marine Splash Well Drain Tube



- These splash well drains are molded of a high strength material that has some flex to allow for imperfect hole saw cuts and installation impacts.
- These drains simply snap together and are impossible to pull apart.
- Transom thickness: 7/8" to 2-1/4".
- Install hole: 1".
- White.

Order No.	Mfg. No. / Description	List Price
6400283	(SWD-2W-DP)	\$5.29

Moeller Flanging Tool



- For 1" drain tubes.
- Sold each per box.

Order No.	Mfg. No. / Description	List Price
486781	(020700-00)	\$47.99

- Electronics
- Trolling Motors
- Instruments
- Electrical
- Lighting
- Anchor & Dock
- Safety
- Steering, Controls
- Pumps
- Fuel System
- Seating & Pedestals
- Trailer
- Tops & Covers
- Perform.
- Propellers
- Engine & Care
- Cleaning & Care
- Paint & Paint Acc.
- Fun & Flotation
- Topside Acc.
- Cockpit & Deck
- Hardware, Fasteners
- Camouflage
- Misc.
- Comm.

Marpac Self Bailing Scupper



- Replace worn out flapper scuppers.
- Large 1-1/8" drain allows 70% more water drainage than nearest competitor.
- Clearing debris is a snap with easy twist-off design.
- Multiple mounting holes make retrofits quick and easy - no filling holes or re-drilling.
- Neutral buoyancy ball insures ball won't float up and break seal.
- Stainless steel security pin provided for added safety.
- Diameter 3", height 2-1/2".

Order No.	Description	List Price
7-0232	Self Bailing Scupper	\$14.29 G0-7590000

T-H Marine Flow-Max® Ball Scupper



- Replaces worn out flapper scuppers.
- 70% more drainage than competitive models.
- Twist off for easy clearing.
- Retrofits all hole patterns.
- Stainless steel lock screw for safety.
- Seal is slotted to fit over 1-1/4" motorwell tube.
- Diameter 3", height 2-1/2".
- Clear.

Order No.	Mfg. No. / Description	List Price
247748	(FMS-1-0-DP)	\$16.29 H0-7790000

T-H Marine Inline Scupper Check Valves



- A great solution to provide a scupper check valve in the drain line.
- Prevents backwash.
- Chemical resistant materials.
- Thermo-plastic flapper.
- Black.

Order No.	Mfg. No. / Description	List Price
247736	(ILS-750-DP) Fits 3/4" Hose	\$23.19 H0-1931000
247737	(ILS-1200-DP) Fits 1-1/8" Hose	\$23.19 H0-1931000
247746	(ILS-1500-DP) Fits 1-1/2" Hose	\$23.19 H0-1931000

T-H Marine Flush Mount Scupper Valve Assembly



- The flapper is molded of a flexible thermo-plastic that is totally impervious to the effects of sun and chemicals.
- Will not curl up, rot or lose their sealing ability.
- Mounts over 1" to 1-1/4" drain tubes.
- Grooved inside to fit over drain flanges.
- Will retrofit other manufacturers' rubber flapper assemblies.
- White with black flapper.

Order No.	Mfg. No. / Description	List Price
641868	(SA-2B-DP)	\$10.89 H0-3560000

Marpac Cockpit Scupper Valve



- Molded white plastic with soft black flapper valve.
- Uses #6 fasteners.
- 2-7/8" OD.
- Note: Fasteners not included.

Order No.	Description	List Price
7-0351	Cockpit Scupper Valve	\$2.39 G0-0610000

Perko Fig. 365 Scupper Valve Assembly for Surface Mount Applications



- For surface mount applications.
- Molded white polymer.
- Soft black flapper.
- Flange OD: 2-7/8".
- Uses #6 fasteners.
- Does not include thru-hull and mounting hardware.

Order No.	Mfg. No. / Description	List Price
237126	(0365 DP)	\$16.09 G0-8701000

T-H Marine Scupper Flapper Repair Kit



- Repairs most scuppers with flappers, regardless of manufacturer.
- These flappers are not rubber, but are molded of a thermoplastic elastomer that is resistant to UV and the elements, so they do not curl like the rubber flappers.
- Kit contains all parts needed to repair 2 scuppers of a given size.
- Each kit contains 2 each of: 1-5/8" flappers, 1-7/8" flappers and all necessary keepers and fasteners.

Order No.	Mfg. No. / Description	List Price
641862	(FSRK-3-DP) Black	\$13.79 H0-7280000

T-H Marine Recessed Threaded Thru-Hull Scuppers



- The flapper is molded of a flexible thermoplastic that is totally impervious to the effects of sun and chemicals.
- These flappers will not curl up, rot or lose their sealing ability.
- This thru-hull type scupper is barbed to fit 1-1/2" and 2" ID hose.
- The threaded portion accommodates hulls up to 3-1/2" thick.
- Mounting nut is included.

Order No.	Mfg. No. / Description	List Price
641832	(RFTH-2B-DP) White with Black Flapper	\$20.09 H0-5021000
6400258	(RFTH-2BCP-DP) Chrome Plated w/Black Flapper	\$26.19 H0-1751000

- Electronics
- Trolling Motors
- Instruments
- Electrical
- Lighting
- Anchor & Dock
- Safety
- Steering, Controls
- Pumps
- Fuel System
- Seating & Pedestals
- Trailering
- Tops & Covers
- Perform.
- Propellers
- Engine & Care
- Cleaning & Care
- Paint & Paint Acc.
- Fun & Flotation
- Topside Acc.
- Cockpit & Deck
- Hardware, Fasteners
- Camouflage
- Misc.
- Comm.

Perko Fig. 323 Thru-Hull Scupper for Mounting Through Transom



- Molded white polymer.
- Soft black flapper.
- For mounting through transom.
- For hose size: 1-1/2".
- Maximum hull thickness: Up to 2-1/8".
- Mounting hole diameter: 1-7/8".
- Flange OD: 2-7/8".
- Complete with nut and mounting hardware.

Order No.	Mfg. No. / Description	List Price
537360	(0323 DP)	\$39.49 G0-6462000

Centek Marine Scupper with Flapper - White



- Made from high-pressure compression molded fiberglass, the Centek Scupper Drain allows water to drain from the deck while also inhibiting the reverse flow of water.
- Not intended for exhaust applications

Order No.	Mfg. No. / Description	List Price
676015	(1200134) Inlet 3"	\$51.09 F0-6753000

T-H Marine Floor Drain and Vent



- Molded black plastic.
- Great for deck drainage.
- Designed with a flange molded into part to fit into hole so that cut or raw edges are hidden by floor drain for a more efficient, attractive installation.
- Works on fiberglass or carpeted surfaces.
- Mounts with 4 screws.

Order No.	Mfg. No.	Overall Diameter	Diameter Hole	List Price
641452	(FD-2-DP)	4-1/4"	2-1/2"	\$5.49 H0-9230000
641464	(FD-4-DP)	5-5/8"	4"	\$7.29 H0-7340000

Perko Fig. 285 Flush Mount Cockpit Scupper for Use with Hose



- Molded white polymer.
- Flush mount.
- For use when discharge is above the waterline.
- Insert prevents passage of large objects without restricting waterflow.
- For hose size: 1-1/2".
- Maximum hull thickness: Up to 1-3/4".
- Flange OD: 2-3/4".
- 1-1/2" ID.

Order No.	Mfg. No. / Description	List Price
536777	(0285 DP)	\$19.59 G0-3131000

T-H Marine All Purpose Drains



- These molded drains offer a low cost method to drain water from virtually anywhere.
- Low profile concave head to allow complete drainage.
- Drains mount easily in a 1-3/8" diameter hole and are secured with the molded nut that is included.
- Hose barbs fit 3/4" hose for routing of drainage.
- Perfect for cooler drains, livewell drains and fiberglass compartments.

Order No.	Mfg. No.	Description	Color	List Price
641470	(APD-1-DP)	Straight	Black	\$5.39 H0-3230000
641475	(APD-2-DP)	Straight	White	\$5.39 H0-3230000
6400088	(APD-190-DP)	90°	Black	\$6.79 H0-7040000

T-H Marine PVC Push-In Drain Plugs



- Handy drain plugs for livewells, cooler compartments and sinks.
- Used to stop water flow through drains or overflows from baitwell or livewell.
- Injection molded of marine grade black PVC.
- Features a pull ring for easy removal.
- They have double seal rings to assure positive sealing.

Order No.	Mfg. No. / Description	List Price
641426	(PP-150-DP) For 1-1/2" Thru-Hull Drains	\$13.39 H0-3080000
641507	(PP-118-DP) For 1-1/8" Thru-Hull Drains	\$8.19 H0-1940000

- Electronics
- Trolling Motors
- Instruments
- Electrical
- Lighting
- Anchor & Dock
- Safety
- Steering, Controls
- Pumps**
- Fuel System
- Seating & Pedestals
- Trailer
- Tops & Covers
- Perform.
- Propellers
- Engine & Care
- Cleaning & Care
- Paint & Paint Acc.
- Fun & Flotation
- Topside Acc.
- Cockpit & Deck
- Hardware, Fasteners
- Camouflage
- Misc.
- Comm.

MPI Products Series 120 Standard Bilge Hose



- Ideal for electric and manual bilge pumps and livewell aerators.
- Heavy-corrugated polyethylene construction with custom molded cuff every foot for easy installation and clamping.
- Excellent flexibility.
- Resists heat, cold, sea water, ozone and oily bilge acids.
- Temperature range is -40° F to 160° F.

SOLD IN 50' BOX

Order No.	Mfg. No. / Description	List Price	
770633	(120-0586) 5/8" Black	\$34.99	HO-9902000
770657	(120-0346) 3/4" Black	\$32.29	HO-7391000
770671	(120-1186) 1-1/8" Black	\$41.99	HO-9152000
770683	(120-1146) 1-1/4" Black	\$61.89	HO-3173000
770708	(120-1126) 1-1/2" Black	\$72.29	HO-7334000
770645	(120-0341) 3/4" x 6' Black, Sold Per Bag	\$5.29	HO-7130000

MPI Products Series 132 Heavy Duty Water Heater Hose



- Used mainly for engine water, water heater, air conditioning circulation, icebox, sink and shower drain lines.
- Heavy EPDM tube and cover reinforced with high-strength polyester yarn.
- Resistant to mild chemicals, heat, cold, ozone and sea water.
- Operating temperature range -40° F to +210° F.
- Sold in 50' box.

BLACK

Order No.	Mfg. No.	Size	Hose Clamp Size (DMI #)	List Price	
769705	(132-0126)	1/2"	3/8" - 7/8"	\$94.29	HO-7565000
770619	(132-0586)	5/8"	1/2" - 1-1/16"	\$101.69	HO-1016000
769743	(132-0346)	3/4"	1/2" - 1-1/4"	\$121.49	HO-9827000
769755	(132-1006)	1"	11/16" - 1-1/2"	\$173.39	HO-3040100

RED

Order No.	Mfg. No.	Size	Hose Clamp Size (DMI #)	List Price	
769731	(132-0586R)	5/8"	1/2" - 1-1/16"	\$104.69	HO-1826000

MPI Products Series 140 and 140W PVC Water Hose



- Temperature range is -40° F to 160° F.
- Sold in 50' box.

SERIES 140 - CORRUGATED PVC WATER HOSE

- Flexible vinyl hose with smooth inside surface for sink and shower drains, potable water fill and heavy duty bilge discharge.
- Excellent bend radius.

Order No.	Mfg. No.	Size	Hose Clamp Size (DMI #)	List Price	
770609	(140-1186)	1-1/8"	11/16" - 1-1/2"	\$102.49	HO-9416000
770623	(140-1126)	1-1/2"	1" - 2"	\$134.39	HO-3608000

SERIES 140W - WIRE REINFORCED PVC WATER HOSE

- Extremely flexible vinyl hose supported by vinyl coated helical steel wire.

Order No.	Mfg. No.	Size	Hose Clamp Size (DMI #)	List Price	
770556	(140-1126W)	1-1/2"	1" - 2"	\$235.09	HO-5014100

MPI Products Series 141 PVC Bilge VAC Hose



- For use in bilge pump discharge, livewell circulation, and scupper drains.
- Corrugated, clear PVC tube reinforced with black PVC helical rod.
- Excellent flexibility.
- Not recommended for use in Alcohol, anti-freeze, petrochemical, mild acid, solvent or pressurized water systems.
- Temperature range is -40° F to 160° F.

SOLD IN 50' BOX

Order No.	Mfg. No.	Size	Hose Clamp Size (DMI #)	List Price	
770722	(141-0346)	3/4"	1/2" - 1-1/16"	\$74.89	HO-3944000
770734	(141-1186)	1-1/8"	11/16" - 1-1/2"	\$95.29	HO-7175000
770746	(141-1126)	1-1/2"	1" - 2"	\$121.09	HO-5627000

SOLD IN 10' LENGTH

Order No.	Mfg. No.	Size	Hose Clamp Size (DMI #)	List Price	
770730	(141-1183)	1-1/8"	11/16" - 1-1/2"	\$22.79	HO-7631000

MPI Products Series 145 Heavy Duty PVC Livewell Hose - Clear



- For use in heavy duty bilge pump discharge and livewell circulation.
- Smooth clear PVC tube reinforced with black PVC helical rod for excellent flexibility.
- Clear smooth outer surface permits easy clamping and visual inspection of blockage.
- Not recommended for use in alcohol, anti-freeze, petrochemical, mild acid, solvent or pressurized water systems.
- Temperature range is -40° F to 160° F.

SOLD IN 50' BOX

Order No.	Mfg. No.	Size	Hose Clamp Size (DMI #)	List Price	
771801	(145-0586)	5/8"	7/16" - 1"	\$74.79	HO-7844000
771813	(145-0346)	3/4"	1/2" - 1-1/16"	\$83.59	HO-5105000
771825	(145-1006)	1"	1/2" - 1-1/4"	\$100.79	HO-7406000
771837	(145-1186)	1-1/8"	11/16" - 1-1/2"	\$111.99	HO-9176000

MPI Products Series 148 Premium PVC Sanitation and Water Hose



- FDA approved compounds.
- For use in holding tank connection, sanitation vent and toilet systems.
- Smooth extra heavy-duty PVC tube, reinforced with PVC helical rod.
- Made with specially formulated FDA approved material to provide excellent resistance to odor permeation and toilet chemicals.
- Not recommended for use in Alcohol, anti-freeze, petrochemical, potable water, solvent or pressurized water systems.
- Temperature range is -40° F to 160° F.

SOLD IN 50' BOX

Order No.	Mfg. No.	Size	Hose Clamp Size (DMI #)	List Price	
771394	(148-0586)	5/8"	7/16" - 1"	\$93.59	HO-5165000
771407	(148-0346)	3/4"	1/2" - 1-1/16"	\$101.99	HO-9116000
771419	(148-1006)	1"	1/2" - 1-1/4"	\$118.29	HO-7907000
771421	(148-1186)	1-1/8"	11/16" - 1-1/2"	\$133.89	HO-3308000
771433	(148-1146)	1-1/4"	3/4" - 1-3/4"	\$153.89	HO-3329000
771445	(148-1126)	1-1/2"	1" - 2"	\$165.69	HO-1499000

MPI Products Series 149 Heavy Duty PVC Livewell - Black

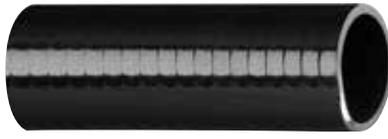

- For use in heavy duty bilge pump discharge and livewell circulation.
- Smooth black PVC tube reinforced with white PVC helical rod.
- Excellent flexibility.
- Smooth outer surface permits easy clamping.
- Not recommended for use in Alcohol, anti-freeze, petrochemical, mild acid, solvent or pressurized water systems.
- Temperature range is -40° F to 160° F.

SOLD IN 50' BOX

Order No.	Mfg. No.	Size	Hose Clamp Size (DMI #)	List Price
771560	(149-0346)	3/4"	1/2" - 1-1/16"	\$80.49
771748	(149-1006)	1"	1/2" - 1-1/4"	\$106.39
771562	(149-1186)	1-1/8"	11/16" - 1-1/2"	\$104.79
771563	(149-1126)	1-1/2"	1" - 2"	\$168.79
771774	(149-2006)	2"	1-1/2" - 2-1/2"	\$316.19

SOLD PER FOOT

Order No.	Mfg. No.	Size	Hose Clamp Size (DMI #)	List Price
7680027	(149-0340)	3/4"	1/2" - 1-1/16"	\$1.59

Trident Ocean-Flex Hose



- This unique marine hose can be used for a multitude of applications for both Commercial and Recreational Vessels including: Fuel Fill, Feed, and Vent (Diesel & Gasoline – Type A1), Lube Oil, Wet Exhaust, Water (Vital and Non-Vital), Bilge, Coolant, Drains, and Sanitation applications.
- OCEAN-FLEX boasts compliance with the following standards: USCG Inspected Vessels (Title 46 CFR Sub-Chap. T), SAE J1942 (Code F, VW, NVW), USCG Type A1, SAE J1527 A1 R2, SAE J2006 R2, SAE J20R2 B, SAE J20R4 B, SAE J20R5 B, SAE J30R5, ABYC H-22, H-24, H-33 P-1, P-4, ISO 7840 A1, ISO 8469 B1, ISO 13363 2B and CE.
- Provides excellent resistance to fuel, fire, heat, cold, ozone and aging.
- Also provides excellent bend-ability and adheres to more standards than any other marine hose.

LENGTH 50'

Order No.	Mfg. No. / Description	List Price
605126	(321-0586) 5/8" ID	\$784.79
605131	(321-0346) 3/4" ID	\$811.79
605136	(321-1006) 1" ID	\$851.49
605141	(321-1126) 1-1/2" ID	\$1,017.49

MPI Products Series 163 Air Conditioning Hose



- Specially formulated for chiller circulation and drain lines in air conditioning systems.
- Extra heavy duty white PVC cover with black PVC inner tube reinforced with braided polyester yarn.
- Superior kink resistance
- Temperature range is -40° F to 160° F.

SOLD IN 50' BOX

Order No.	Mfg. No.	Size	Hose Clamp Size (DMI #)	List Price
769654	(163-0586)	5/8"	7/16" - 1"	\$65.69

MPI Products Series 150 Clear PVC Tubing



- Excellent for use in cool water applications such as fresh water, sink, shower, livewell NON-TOXIC vinyl produced FDA approved compound.
- Temperature range is -40° F to 160° F.

SOLD IN 50' BOX

Order No.	Mfg. No.	Size	Hose Clamp Size (DMI #)	List Price
770760	(150-0386)	3/8"	3/8" - 7/8"	\$37.39
770772	(150-0126)	1/2"	3/8" - 7/8"	\$61.89
770784	(150-0586)	5/8"	7/16" - 1"	\$73.29
770796	(150-0346)	3/4"	1/2" - 1-1/16"	\$85.19
770809	(150-1006)	1"	11/16" - 1-1/2"	\$133.79

MPI Products Series 162, 164, 165 Clear Reinforced Tubing



Series 162

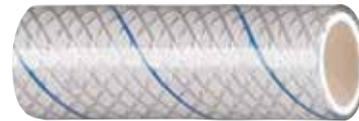

Series 164



Series 165

- Excellent for use in potable water, as well as hot and cold pressurized water applications.
- Heavy duty clear vinyl, non-toxic reinforced tubing produced with an odorless and tasteless FDA approved compound.
- Temperature range is -40° F to 150° F.
- Sold in 50' Box.

SERIES 162 - CLEAR REINFORCED TUBING (RED AND BLUE TRACER)

Order No.	Mfg. No.	Size	Hose Clamp Size (DMI #)	List Price
770900	(162-0386)	3/8"	3/8" - 7/8"	\$46.09
770912	(162-0126)	1/2"	7/16" - 1"	\$58.39
770924	(162-0586)	5/8"	7/16" - 1"	\$65.39
770936	(162-0346)	3/4"	1/2" - 1-1/16"	\$84.79
770948	(162-1006)	1"	1" - 2"	\$120.49
770950	(162-1186)	1-1/8"	1" - 2"	\$142.39
770962	(162-1146)	1-1/4"	1-1/4" - 2-1/4"	\$219.99
770974	(162-1126)	1-1/2"	1-1/4" - 2-1/4"	\$314.09

SERIES 164 - WHITE REINFORCED TUBING (BLUE TRACER)

Order No.	Mfg. No.	Size	Hose Clamp Size (DMI #)	List Price
770998	(164-0126)	1/2"	7/16" - 1"	\$54.59
771003	(164-0586)	5/8"	7/16" - 1"	\$68.29
771015	(164-0346)	3/4"	1/2" - 1-1/16"	\$86.69

SERIES 165 - HEAVY DUTY CLEAR REINFORCED TUBING

Order No.	Mfg. No.	Size	Hose Clamp Size (DMI #)	List Price
771039	(165-0126)	1/2"	7/16" - 1"	\$64.09
771041	(165-0346)	5/8"	7/16" - 1"	\$117.49
771053	(165-0586)	3/4"	1/2" - 1-1/16"	\$89.99

- Electronics
- Trolling Motors
- Instruments
- Electrical
- Lighting
- Anchor & Dock
- Safety
- Steering, Controls
- Pumps
- Fuel System
- Seating & Pedestals
- Trailering
- Tops & Covers
- Perform.
- Propellers
- Engine & Care
- Cleaning & Care
- Paint & Paint Acc.
- Fun & Flotation
- Topside Acc.
- Cockpit & Deck
- Hardware, Fasteners
- Camouflage
- Misc.
- Comm.

Conversion Table - Pipe Size OD (Outside Diameter) to Hose Size ID (Inside Diameter)

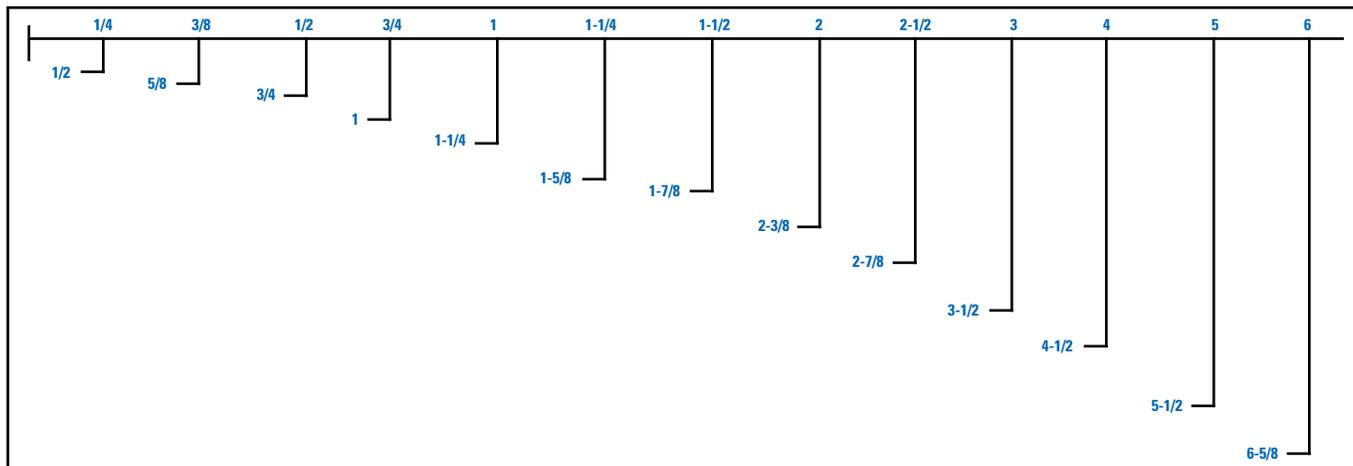

- Electronics
- Trolling Motors
- Instruments
- Electrical
- Lighting
- Anchor & Dock
- Safety
- Steering, Controls
- Pumps
- Fuel System
- Seating & Pedestals
- Trailering
- Tops & Covers
- Perform.
- Propellers
- Engine & Care
- Cleaning & Care
- Paint & Paint Acc.
- Fun & Flotation
- Topside Acc.
- Cockpit & Deck
- Hardware, Fasteners
- Camouflage
- Misc.
- Comm.

Marpac Universal Hose Clamps



- Easily attach and seal a hose onto a fitting or barb.
- Stainless steel construction for a long lifetime.
- Sold 2 per package.

Order No.	Description	List Price
7-57202	1/4" - 5/8"	\$2.39
7-57204	3/8" - 7/8"	\$2.29
7-57206	7/16" - 1"	\$2.69
7-57208	1/2" - 1-1/16"	\$3.39
7-57210	5/8" - 1-1/4"	\$3.69
7-57212	3/4" - 1-1/2"	\$4.09

Ideal Micro-Gear 62M Stainless Steel Hose Clamps



- All 300 grade stainless steel marine grade clamp.
- These clamps are tiny, tough and precision engineered for use in such small hose applications.
- Their slim 5/16" band and low profile housing makes them easy to install in confined areas.

DMI #	MFG #	Size	Clamp Dia.	Fits Hose OD	List Price
276015	(6260451)	04	1/4" - 5/8"	1/8" to 5/16"	\$1.09
276027	(6260651)	06	5/16" - 7/8"	1/4" to 7/16"	\$1.29

Sierra Stainless Steel Hose Clamps



Order No.	Mfg. No. / Description	List Price
187300	(18-7300) Diameter Size: 50mm	\$3.49
187306	(18-7306) Diameter Size: 38mm	\$2.49

Shields Stainless Steel Hose Clamps



- All components are manufactured from marine grade 316 stainless steel.

Order No.	Mfg. No. / Description	List Price
187307	(18-710-06-2) Diameter Size: 7/16" - 3/4"	\$3.49
187308	(18-710-10-2) Diameter Size: 9/16" - 1-1/16"	\$4.19
187309	(18-710-12-2) Diameter Size: 11/16" - 1-1/4"	\$2.99
187310	(18-710-16-2) Diameter Size: 11/16" - 1-1/2"	\$2.99
187311	(18-710-20-2) Diameter Size: 13/16" - 1-3/4"	\$4.99
187312	(18-710-24-2) Diameter Size: 1-1/16" - 2"	\$3.95
187314	(18-710-48-2) Diameter Size: 2-9/16" - 3-1/2"	\$6.99
187315	(18-7315) Diameter Size: 2-1/2" - 4-1/2"	\$6.99

AWAB 316 Stainless Steel Hose Clamps



- Features rolled band edges to eliminate the risk of damage to the hose.
- The extra wide threads of the band are stamped, leaving the unperforated band smooth on the inside.
- Sold 10 per box.

Order No.	Mfg. No. / Description	List Price
275506	(705-0561) SAE Size: 4 7/16" - 11/16"	\$19.59
275518	(705-0381) SAE Size: 6 1/2" - 13/16"	\$20.39
275520	(710-0121) SAE Size: 8 5/8" - 15/16"	\$28.99
275532	(710-0581) SAE Size: 10 3/4" - 1-1/8"	\$29.19
275544	(710-0341) SAE Size: 12 7/8" - 1-1/4"	\$31.29
275556	(710-1001) SAE Size: 16 1-1/16" - 1-1/2"	\$32.49
275568	(710-1141) SAE Size: 20 1-1/4" - 1-3/4"	\$34.89
275570	(710-1381) SAE Size: 24 1-1/2" - 2"	\$36.09
275582	(710-1121) SAE Size: 28 1-1/4" - 2-1/4"	\$35.69
275594	(710-2001) SAE Size: 32 1-1/2" - 2-1/2"	\$38.29
275619	(710-2141) SAE Size: 40 2" - 3"	\$40.69
275621	(710-2121) SAE Size: 44 2-1/4" - 3-1/4"	\$43.29
275645	(710-3001) SAE Size: 52 2-3/4" - 3-3/4"	\$45.89
275671	(710-3121) SAE Size: 64 3-1/2" - 4-1/2"	\$56.69

Ideal 9/16" Hy-Gear® Stainless Steel Hose Clamps



- 300 grade stainless steel.
- High nickel alloy stainless steel meets the demands of inground and marine use.
- A marine grade clamp for boating applications and other corrosive environments.
- Band and housing: 9/16" wide.
- Sold box of 10.

DMI #	MFG #	Size	Min. (mm)	Max. (mm)	List Price
276039	(630040006051)	06	3/8" (10)	7/8" (22)	\$1.59
276041	(630040008051)	08	7/16" (11)	1" (25)	\$1.59
276053	(630040010051)	10	1/2" (13)	1-1/16" (27)	\$1.59
276067	(630040012051)	12	1/2" (13)	1-1/4" (32)	\$1.59
276079	(630040016051)	16	11/16" (18)	1-1/2" (38)	\$1.59
276089	(630040020051)	20	3/4" (19)	1-3/4" (44)	\$1.69
276091	(630040024051)	24	1" (25)	2" (51)	\$1.69
276104	(630040028051)	28	1-1/4" (32)	2-1/4" (57)	\$1.69
276116	(630040032051)	32	1-1/2" (38)	2-1/2" (63)	\$1.69
276128	(630040036051)	36	3/4" (19)	2-3/4" (70)	\$1.69
276130	(630040040051)	40	1" (26)	3" (76)	\$1.89
276134	(630040044051)	44	1-1/4" (32)	3-1/4" (83)	\$2.09
276142	(630040048051)	48	1-1/2" (38)	3-1/2" (89)	\$2.09
276146	(630040052051)	52	1-3/4" (44)	3-3/4" (95)	\$2.29
276154	(630040056051)	56	2" (51)	4" (101)	\$2.29
276166	(630040064051)	64	2-1/2" (64)	4-1/2" (114)	\$2.49
276178	(630040072051)	72	3" (76)	5" (127)	\$2.59
276180	(630040080051)	80	3-1/2" (89)	5-1/2" (140)	\$2.79
276192	(630040088051)	88	4" (102)	6" (152)	\$2.89
276205	(630040096051)	96	4-1/2" (114)	6-1/2" (165)	\$2.99
276217	(630040104051)	104	5" (127)	7" (178)	\$3.09

Marpac Hose Clamp Display



- This display includes the following:
 - (10) 276015 - Clamp Diameter 1/4" - 5/8"
 - (10) 276027 - Clamp Diameter 5/16" - 7/8", 1/4" to 7/16"
 - (10) 276053 - Clamp Diameter 1/2" - 1-1/16"
 - (10) 276079 - Clamp Diameter 3/4" - 1-1/2"
 - (10) 276089 - Clamp Diameter 3/4" - 1-3/4"
 - (10) 276091 - Clamp Diameter 1" - 2"
 - (10) 276128 - Clamp Diameter 7/8" - 2-3/4"
 - (10) 276142 - Clamp Diameter 1-5/8" - 3-1/2"

Order No.	Description	List Price
7-3005	Hose Clamp Display	\$203.79

Sierra Oetiker Hose Clamps



- Size is for outside diameter of hose.
- Sold 10 per package.

Order No.	Mfg. No. / Description	Size	List Price
1891269	(18-9126-9) Hose OD 3/8"	9.5 mm	\$17.26
1891279	(18-9127-9) Hose OD 13/32"	10.5 mm	\$14.37
1891289	(18-9128-9) Hose OD 7/16"	11.3 mm	\$14.39
1891299	(18-9129-9) Hose OD 1/2"	13.3 mm	\$19.74
1891309	(18-9130-9) Hose OD 17/32"	13.8 mm	\$18.99
1891319	(18-9131-9) Hose OD 35/64"	14 mm	\$15.29
1891329	(18-9132-9) Hose OD 9/16"	14.5 mm	\$15.25
1891339	(18-9133-9) Hose OD 5/8"	15.7 mm	\$9.37
1891349	(18-9134-9) Hose OD 11/16"	17 mm	\$14.23
1891359	(18-9135-9) Hose OD 13/16"	21 mm	\$15.99
1891369	(18-9136-9) Hose OD 1"	25.6 mm	\$15.05
1891379	(18-9137-9) Hose OD 1-3/16"	30.1 mm	\$19.49
1891389	(18-9138-9) Hose OD 1-1/4"	31.6 mm	\$16.85
1891399	(18-9139-9) Hose OD 1-5/8"	41 mm	\$39.95
1891409	(18-9140-9) Hose OD 22/32"	18.5 mm	\$21.99

2 Ear Crimp Hose Clamp



- Stainless steel.
- Nominal size 3/4". Width .335".
- Closed/open .669/.787".

Order No.	Mfg. No. / Description	List Price
645768	(4E589)	\$4.16

MPI Products T-Bolt Exhaust Hose Clamps



- Constructed of 18-8 stainless steel.
- .025" thick x .75" wide.
- With a nylon insert lock nut.
- The extra long t-bolt complies with most exhaust hose requirements.

Order No.	Mfg. No.	Hose ID	Diameter Range	List Price
769010	(720-1000)	1"	1.36" - 1.50"	\$10.89
769022	(720-1120)	1-1/2"	1.87" - 2.12"	\$10.89
769034	(720-1340)	1-3/4"	2.03" - 2.34"	\$10.89
769105	(720-2000)	2"	2.23" - 2.54"	\$11.29
769107	(720-2120)	2-1/2"	2.78" - 3.09"	\$12.59
769109	(720-3000)	3"	3.30" - 3.95"	\$12.29
769072	(720-3120)	3-1/2"	3.50" - 4.15"	\$13.89
769111	(720-4000)	4"	4.13" - 4.78"	\$12.69
769096	(720-4120)	4-1/2"	4.75" - 5.40"	\$14.79
769123	(720-5000)	5"	5.30" - 5.95"	\$15.09
769135	(720-6000)	6"	6.35" - 7.00"	\$13.99
769147	(720-8000)	8"	8.40" - 9.05"	\$14.49

- Electronics
- Trolling Motors
- Instruments
- Electrical
- Lighting
- Anchor & Dock
- Safety
- Steering, Controls
- Pumps
- Fuel System
- Seating & Pedestals
- Trailering
- Tops & Covers
- Perform.
- Propellers
- Engine & Care
- Cleaning & Care
- Paint & Paint Acc.
- Fun & Flotation
- Topside Acc.
- Cockpit & Deck
- Hardware, Fasteners
- Camouflage
- Misc.
- Comm.

T-H Marine Stainless Steel Oetiker® Hose Clamps



- All 304 stainless steel.
- Narrow band - 7mm.
- Lightweight design.
- Specially formed strip edges reduce the risk of damage to the part being clamped.
- Mechanical interlock allows use of pre-coated materials.
- Tampering is visible.
- Fast, simple and safe installation.
- Sold 100 per bag.

Order No.	Mfg. No. / Description	List Price	
6400064	(15500007) Nominal Size: 9/16"	\$57.79	HO-7643000
6400065	(15500008) Nominal Size: 5/8"	\$58.79	HO-7253000
6400066	(15500009) Nominal Size: 11/16"	\$62.29	HO-7373000

T-H Marine Oetiker® Standard Jaw Pincer



Order No.	Mfg. No. / Description	List Price	
6400062	(14100396)	\$81.89	HO-3194000

Sierra Stepless Clamp 90° Tool



- Fits: Crimp type stepless clamps.

Order No.	Mfg. No. / Description	List Price	
1879823	(18-79823)	\$82.49	Z0-0094000

T-H Marine Oetiker® Stainless Steel Stepless® Ear Hose Clamps



- All 304 stainless steel.
- Lightweight design.
- Specially formed strip edges reduce the risk of damage to the part being clamped.
- Mechanical interlock allows use of pre-coated materials.
- Tampering is visible.
- Fast, simple and safe installation.
- Sold 100 per bag.

Order No.	Mfg. No. / Description	List Price	
	(16700004) 7.8 - 9.5 mm	\$70.09	HO-5024000
247810	(16700006) 8.8 - 10.5 mm (3/8")	\$70.09	HO-5024000
7001360	(16700007) 9.6 - 11.3 mm	\$68.39	HO-3014000
7001362	(16700010) 10.8 - 13.3 mm	\$70.59	HO-5324000
247818	(16700011) 11.0 - 13.8 mm	\$70.59	HO-5324000
7001364	(16700012) 11.5 - 14.0 mm	\$73.09	HO-5834000
7001366	(16700013) 12.0 - 14.5 mm	\$73.09	HO-5834000
7001368	(16700016) 13.2 - 15.7 mm	\$69.89	HO-3914000
247821	(16700017) 14.5 - 17.0 mm (5/8")	\$69.89	HO-3914000
7001370	(16700020) 15.3 - 18.5 mm	\$81.99	HO-9194000
247829	(16700024) 17.8 - 21.0 mm (3/4")	\$81.99	HO-9194000
247836	(16700031) 22.4 - 25.6 mm (1")	\$89.69	HO-1835000
7001372	(16700037) 26.9 - 30.1 mm (1-1/8")	\$89.99	HO-9935000
247842	(16705000) 34.9 - 38.1 mm (1-1/2")	\$125.99	HO-9557000
7001376	(16705989) 37.8 - 41.0 mm	\$125.99	HO-9557000

T-H Marine Oetiker® Stepless® Ear Clamp Kit



- Great for shop or rigging work.
 - Complete with crimping tool.
 - Contains 10 each of the following sizes:
- | | |
|---------|------------------------------------|
| 247805 | (16700001) 5.8 - 7.0 mm |
| 247808 | (16700004) 7.8 - 9.5 mm |
| 247810 | (16700006) 8.8 - 10.5 mm (3/8") |
| 7001360 | (16700007) 9.6 - 11.3 mm |
| 7001362 | (16700010) 10.8 - 13.3 mm |
| 7001364 | (16700012) 11.5 - 14.0 mm |
| 7001366 | (16700013) 12.0 - 14.5 mm |
| 7001368 | (16700016) 13.2 - 15.7 mm |
| 247821 | (16700017) 14.5 - 17.0 mm (5/8") |
| 7001370 | (16700020) 15.3 - 18.5 mm |
| 247829 | (16700024) 17.8 - 21.0 mm (3/4") |
| 247836 | (16700031) 22.4 - 25.6 mm (1") |
| 7001372 | (16700037) 26.9 - 30.1 mm (1-1/8") |
| 7001374 | (16700040) 28.4 - 31.6 mm |
| 7001376 | (16705989) 37.8 - 41.0 mm |

Order No.	Mfg. No. / Description	List Price	
642656	(18500000)	\$198.49	HO-9091100



Freshwater Exclusive



Saltwater Exclusive

Brass Pipe Reducing Couplings



Order No.	Description	List Price	
467414	3/8" x 1/4" NPT	\$12.19	GO-7180000
467438	1/2" x 3/8" NPT	\$15.09	GO-1101000
467440	3/4" x 1/2" NPT	\$22.49	GO-7051000
467452	1" x 3/4" NPT	\$37.39	GO-5052000
467464	1-1/4" x 1" NPT	\$60.29	GO-9304000

Brass 90° Pipe Elbows



Order No.	Description	List Price	
467109	3/8" NPT	\$11.29	GO-6570000
467111	1/2" NPT	\$17.19	GO-2511000
467123	3/4" NPT	\$23.09	GO-7451000
467135	1" NPT	\$35.59	GO-5832000
467147	1-1/4" NPT	\$56.69	GO-8973000
467159	1-1/2" NPT	\$70.79	GO-3474000
467160	2" NPT	\$115.09	GO-1177000

Brass Pipe Tees



Order No.	Description	List Price	
467856	1/4" NPT	\$15.69	GO-1501000
467868	3/8" NPT	\$15.69	GO-1501000
467870	1/2" NPT	\$19.79	GO-6231000
467882	3/4" NPT	\$28.39	GO-2091000
467894	1" NPT	\$50.49	GO-3833000
467907	1-1/4" NPT	\$70.79	GO-3474000
467919	1-1/2" NPT	\$97.29	GO-8156000

Brass 90° Pipe Street Elbows



Order No.	Description	List Price	
467250	1/4" NPT	\$17.19	GO-2511000
467262	3/8" NPT	\$17.19	GO-2511000
467274	1/2" NPT	\$21.29	GO-6241000
467286	3/4" NPT	\$30.09	GO-6102000
467298	1" NPT	\$45.59	GO-5503000
467301	1-1/4" NPT	\$76.09	GO-8905000
467313	1-1/2" NPT	\$99.19	GO-6466000
467315	2" NPT	\$168.09	GO-2621100

Brass Pipe Plugs



Order No.	Description	List Price	
467591	1/8" NPT	\$1.09	GO-3700000
467604	1/4" NPT	\$1.59	GO-7010000
467616	3/8" NPT	\$2.59	GO-4710000
467628	1/2" NPT	\$4.29	GO-7820000
467630	3/4" NPT	\$13.59	GO-1190000
467642	1" NPT	\$17.89	GO-9911000

Brass Pipe Couplings



Order No.	Description	List Price	
467337	1/4" NPT	\$11.29	GO-6570000
467349	3/8" NPT	\$11.29	GO-6570000
467351	1/2" NPT	\$14.19	GO-1590000
467363	3/4" NPT	\$18.69	GO-2521000
467375	1" NPT	\$28.39	GO-2091000
467387	1-1/4" NPT	\$44.39	GO-4792000
467389	1-1/2" NPT	\$60.29	GO-9304000

Brass 45° Pipe Elbow



Order No.	Description	List Price	
467205	3/4" NPT	\$23.09	GO-7451000

Brass Pipe Locknuts



Order No.	Description	List Price	
467820	1-1/2" NPT	\$33.59	GO-1522000

Brass Pipe Cap



Order No.	Description	List Price	
467717	3/4" NPT	\$14.99	GO-4001000

Brass Pipe Bushings



Order No.	Description	List Price	
467488	1/4" x 1/8" NPT	\$1.59	GO-7010000
467490	3/8" x 1/8" NPT	\$2.39	GO-0610000
467515	3/8" x 1/4" NPT	\$2.79	GO-7810000
467527	1/2" x 1/4" NPT	\$4.69	GO-4130000
467539	1/2" x 3/8" NPT	\$3.49	GO-4320000
467541	3/4" x 1/2" NPT	\$12.39	GO-0380000
467542	3/4" x 3/8" NPT	\$12.39	GO-0380000
467560	1" x 1/2" NPT	\$18.69	GO-2521000
467565	1" x 3/4" NPT	\$18.69	GO-2521000
467577	1-1/4" x 3/4" NPT	\$31.89	GO-7312000
467589	1-1/4" x 1" NPT	\$31.89	GO-7312000
467568	1-1/2" x 1" NPT	\$40.69	GO-6272000
467503	1-1/2" x 1-1/4" NPT	\$40.69	GO-6272000
467573	2" x 1-1/4" NPT	\$60.29	GO-9304000
467590	2" x 1-1/2" NPT	\$60.29	GO-9304000

Brass Pipe Nipples



Order No.	Description	List Price		Order No.	Description	List Price	
466688	1/4" NPT, Close	\$6.99	GO-8640000	466866	3/4" NPT, 4" L	\$29.99	GO-9002000
466689	1/4" NPT, 1-1/2" L	\$8.09	GO-2450000	466880	1" NPT, Close	\$20.19	GO-3531000
466727	3/8" NPT, Close	\$7.29	GO-8840000	466892	1" NPT, 2" L	\$24.79	GO-1661000
466739	3/8" NPT, 1-1/2" L	\$8.59	GO-6750000	466905	1" NPT, 3" L	\$33.29	GO-0322000
466741	3/8" NPT, 2" L	\$10.39	GO-6960000	466917	1" NPT, 4" L	\$43.39	GO-7092000
466791	1/2" NPT, Close	\$9.69	GO-9460000	466931	1-1/4" NPT, Close	\$30.39	GO-6302000
466792	1/2" NPT, 1-1/2" L	\$10.99	GO-6370000	466936	1-1/4" NPT, 2" L	\$34.69	GO-4232000
466804	1/2" NPT, 2" L	\$13.09	GO-7780000	466993	1-1/2" NPT, Close	\$39.49	GO-6462000
466830	3/4" NPT, Close	\$13.69	GO-7190000	467008	1-1/2" NPT, 2" L	\$42.39	GO-0482000
466831	3/4" NPT, 1-1/2" L	\$14.89	GO-8990000	467011	1-1/2" NPT, 3" L	\$58.39	GO-2193000
466842	3/4" NPT, 2" L	\$17.19	GO-2511000	467042	2" NPT, Close	\$59.99	GO-9104000
466854	3/4" NPT, 3" L	\$22.99	GO-0451000				

- Electronics
- Trolling Motors
- Instruments
- Electrical
- Lighting
- Anchor & Dock
- Safety
- Steering, Controls
- Pumps
- Fuel System
- Seating & Pedestals
- Trailering
- Tops & Covers
- Perform.
- Propellers
- Engine & Care
- Cleaning & Care
- Paint & Paint Acc.
- Fun & Flotation
- Topside Acc.
- Cockpit & Deck
- Hardware, Fasteners
- Camouflage
- Misc.
- Comm.

Groco PTH Series NPT Standard Flow Pipe to Hose Fittings

GROCO.

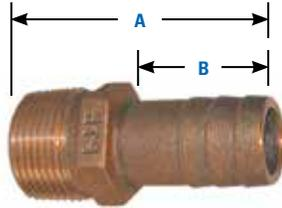

- Standard flow - the hose ID is the same as the pipe size.
- C83600 Bronze - not compliant with NSF-61 no-lead standard.
- DO NOT use in potable water systems.
- Sizes from 1/2" to 5".
- UL Listed 647B.

Order No.	Mfg. No.	Thread NPT	Hose ID	A	B
371207	(PTH-5062)	1/2"	1/2" or 5/8"	2.7"	1.8"
542046	(PTH-0750)	3/4"	3/4"	2.39"	1.38"
542058	(PTH-1000)	1"	1"	2.48"	1.38"
371384	(PTH-1125)	1-1/4"	1-1/8"	2.48"	1.38"
542060	(PTH-1250)	1-1/4"	1-1/4"	2.65"	1.55"
542072	(PTH-1500)	1-1/2"	1-1/2"	3"	1.9"
542084	(PTH-2000)	2"	2"	3"	1.9"
371423	(PTH-2500)	2-1/2"	2-1/2"	4"	2"
371435	(PTH-3000)	3"	3"	4"	2"
371447	(PTH-4000)	4"	4"	4.25"	2"

Order No.	Mfg. No.	List Price	Part No.
371207	(PTH-5062)	\$8.19	GO-9450000
542046	(PTH-0750)	\$8.99	GO-2060000
542058	(PTH-1000)	\$12.79	GO-7580000
371384	(PTH-1125)	\$21.99	GO-3741000
542060	(PTH-1250)	\$24.79	GO-1661000
542072	(PTH-1500)	\$28.19	GO-9881000
542084	(PTH-2000)	\$32.19	GO-7512000
371423	(PTH-2500)	\$57.19	GO-2383000
371435	(PTH-3000)	\$89.09	GO-9695000
371447	(PTH-4000)	\$153.69	GO-7920100

Groco FF Series NPT Full Flow Pipe to Hose Fittings

GROCO.

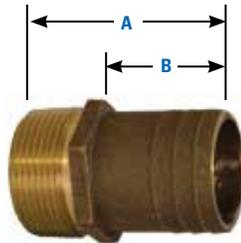

- Full flow - the hose ID that fits is larger than the pipe size.
- C83600 Bronze - not compliant with NSF-61 lead-free standard.
- DO NOT use in potable water systems.
- Sizes from 1/2" to 3".
- UL Listed 647B.

Order No.	Mfg. No.	Thread NPT	Hose ID	A	B
371212	(FF-0500)	1/2"	3/4"	2.28"	1.38"
371219	(FF-0750)	3/4"	1"	2.39"	1.38"
371221	(FF-1000)	1"	1-1/4"	2.48"	1.38"
371227	(FF-1125)	1"	1-1/8"	2.48"	1.38"
371233	(FF-1250)	1-1/4"	1-1/2"	2.65"	1.55"
371245	(FF-1500)	1-1/2"	1-3/4"	3.00"	1.9"
371257	(FF-2000)	2"	2-1/4"	2.89"	1.75"
371259	(FF-2500)	2-1/2"	2-3/4"	3.47"	2"
371263	(FF-3000)	3"	3-1/2"	3.61"	2"

Order No.	Mfg. No.	List Price	Part No.
371212	(FF-0500)	\$10.49	GO-3070000
371219	(FF-0750)	\$12.69	GO-0580000
371221	(FF-1000)	\$16.39	GO-8901000
371227	(FF-1125)	\$16.39	GO-8901000
371233	(FF-1250)	\$28.19	GO-9881000
371245	(FF-1500)	\$32.69	GO-0912000
371257	(FF-2000)	\$67.49	GO-2254000
371259	(FF-2500)	\$76.89	GO-2515000
371263	(FF-3000)	\$123.69	GO-7828000

Groco PTHC Series NPT Standard Flow Pipe to Hose Elbows

GROCO.

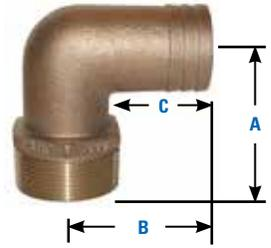

- Standard flow - the hose ID that fits is the same as the pipe size.
- C83600 Bronze - not compliant with NSF-61 no-lead standard.
- DO NOT use in potable water systems.
- Sizes from 1/2" to 5".
- UL Listed 647B.

Order No.	Mfg. No.	Thread NPT	Hose ID	A	B	C
371461	(PTHC-5062)	1/2"	1/2" or 5/8"	1.9"	2"	1.56"
541323	(PTHC-0750)	3/4"	3/4"	1.86"	2.05"	1.43"
541335	(PTHC-1000)	1"	1"	2.34"	2.40"	1.63"
541347	(PTHC-1125)	1-1/4"	1-1/8"	2.37"	2.44"	1.75"
371497	(PTHC-1250)	1-1/4"	1-1/4"	2.44"	2.53"	1.38"
541359	(PTHC-1500)	1-1/2"	1-1/2"	2.50"	2.50"	2.25"
371512	(PTHC-2000)	2"	2"	2.88"	3.10"	2.25"
371524	(PTHC-2500)	2-1/2"	2-1/2"	3.83"	3.35"	2.10"
371536	(PTHC-3000)	3"	3"	4.20"	3.55"	2.85"

Order No.	Mfg. No.	List Price	Part No.
371461	(PTHC-5062)	\$12.69	GO-0580000
541323	(PTHC-0750)	\$14.69	GO-4890000
541335	(PTHC-1000)	\$23.09	GO-7451000
541347	(PTHC-1125)	\$31.29	GO-6902000
371497	(PTHC-1250)	\$33.79	GO-4622000
541359	(PTHC-1500)	\$46.09	GO-8803000
371512	(PTHC-2000)	\$56.29	GO-1773000
371524	(PTHC-2500)	\$87.19	GO-2485000
371536	(PTHC-3000)	\$114.39	GO-4667000

Groco FFC Series NPT Full Flow Pipe to Hose Elbows

GROCO.

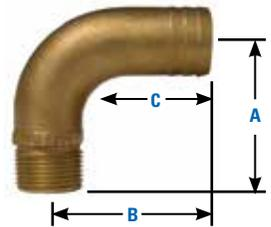

- Full flow.
- 90 degree Male NPT x Hose connection.
- C83600 Bronze - not compliant with NSF-61 lead-free standard.
- DO NOT use in potable water systems.
- Sizes from 1/2" to 3".
- UL Listed 647B.

Order No.	Mfg. No.	Thread NPT	Hose ID	A	B	C
371266	(FFC-0500)	1/2"	3/4"	2.06"	2.25"	1.38"
371269	(FFC-0750)	3/4"	1"	2"	2.2"	1.45"
371271	(FFC-1000)	1"	1-1/4"	2.7"	3"	1.63"
371275	(FFC-1125)	1"	1-1/8"	2.38"	2.44"	1.75"
371283	(FFC-1250)	1-1/4"	1-1/2"	3.6"	3.43"	1.38"
371295	(FFC-1500)	1-1/2"	1-3/4"	4.25"	4.4"	1.78"
371308	(FFC-2000)	2"	2-1/4"	5.4"	5.15"	1.85"
371310	(FFC-2500)	2-1/2"	2-3/4"	6.55"	6"	2"

Order No.	Mfg. No.	List Price	Part No.
371266	(FFC-0500)	\$16.39	GO-8901000
371269	(FFC-0750)	\$23.09	GO-7451000
371271	(FFC-1000)	\$33.79	GO-4622000
371275	(FFC-1125)	\$32.69	GO-0912000
371283	(FFC-1250)	\$52.89	GO-4453000
371295	(FFC-1500)	\$68.59	GO-6954000
371308	(FFC-2000)	\$128.39	GO-2068000
371310	(FFC-2500)	\$219.29	GO-2964100

Groco PTHD Series NPT Standard Flow Pipe to Hose Elbows

GROCO.

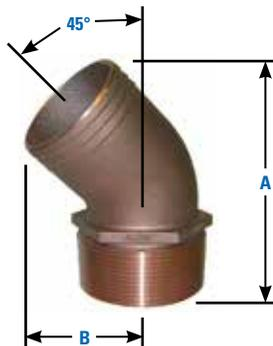

- Standard flow - the hose that fits is the same as the pipe size.
- C83600 Bronze - not compliant with NSF-61 no-lead standard.
- DO NOT use in potable water systems.
- Sizes from 3/4" to 3".
- UL Listed 647B.

Order No.	Mfg. No.	Thread NPT	Hose ID	A	B
371550	(PTHD-0750)	3/4"	3/4"	2.98"	1.58"
371562	(PTHD-1000)	1"	1"	3.15"	1.63"
371574	(PTHD-1250)	1-1/4"	1-1/4"	3.34"	1.68"
371586	(PTHD-1500)	1-1/2"	1-1/2"	3.73"	1.99"
371598	(PTHD-2000)	2"	2"	4.12"	2.36"
371613	(PTHD-3000)	3"	3"	6.03"	3.06"

Order No.	Mfg. No.	List Price	
371550	(PTHD-0750)	\$15.79	GO-8501000
371562	(PTHD-1000)	\$22.49	GO-7051000
371574	(PTHD-1250)	\$30.39	GO-6302000
371586	(PTHD-1500)	\$43.89	GO-1492000
371598	(PTHD-2000)	\$57.39	GO-5483000
371613	(PTHD-3000)	\$113.39	GO-7957000

Forespar Tailpipes

FORESPAR®



- Molded from high-strength Marelon.
- Zero corrosion and light weight. zero corrosion, zero electrolysis, light weight and strong Marelon.
- Pipe to assorted hose sizes.

Order No.	Mfg. No. / Description	List Price	
354427	(910148) 1/4" Thread Tube ID 3/8"	\$2.39	GO-0610000
354465	(910156) 1/2" Thread Tube ID 1/2"	\$3.99	GO-7620000
354477	(910157) 1/2" Thread Tube ID 3/4"	\$4.39	GO-4920000
354489	(910158) 3/4" Thread Tube ID 1/2"	\$5.59	GO-5730000
354491	(910159) 3/4" Thread Tube ID 3/4"	\$6.19	GO-5140000
354516	(910168) 1-1/4" Thread Tube ID 1-1/2"	\$9.49	GO-6360000

Forespar Ball Valves

FORESPAR®



- Molded in high strength glass reinforced "Marelon".
- Great strength, light weight, easy installation and maintenance as well as freedom from corrosion and electrolysis creates the ideal valve for controlling inlet and outlet waterflow above and below the waterline.
- P.T.F.E. seals are supplied.

Order No.	Mfg. No. / Description	List Price	
354136	(905101) 3/4" NPT	\$56.39	GO-8773000

Buck Algonquin "Tuff-Lite" Nylon Hose Adapter

BUCK ALGONQUIN



- Nylon.
- Hexed for easy installation.
- 1-1/2" NPT, hose 1-1/2" ID.
- Overall length 2-3/4".

Order No.	Mfg. No. / Description	List Price	
354679	(60TN200)	\$3.09	GO-7020000

Forespar 90° Elbows

FORESPAR®



- Molded from high-strength Marelon.
- Zero corrosion and light weight. zero corrosion, zero electrolysis, light weight and strong Marelon.

Order No.	Mfg. No. / Description	List Price	
354263	(901000) 1/2" IPT Hose ID 5/8"	\$3.89	GO-1620000
354275	(901001) 3/4" IPT Hose ID 3/4"	\$4.79	GO-1230000
354287	(901002) 1" IPT Hose ID 1"	\$6.89	GO-2640000
354299	(901003) 1-1/4" IPT Hose ID 1-1/4"	\$8.49	GO-9650000
354302	(901004) 1-1/2" IPT Hose ID 1-1/2"	\$11.89	GO-7970000

Forespar Tailpipes

FORESPAR®



- Molded from high-strength Marelon.
- Zero corrosion and light weight. zero corrosion, zero electrolysis, light weight and strong Marelon.
- Perfect choice for joining hose lines to ball valves and seaocks.

Order No.	Mfg. No. / Description	List Price	
354201	(905006) 1/2" NPT Hose ID 1/2"	\$4.89	GO-8230000
354213	(905007) 3/4" NPT Hose ID 3/4"	\$4.79	GO-1230000
354225	(905008) 1" NPT Hose ID 1"	\$8.69	GO-2850000
354237	(905009) 1-1/4" NPT Hose ID 1-1/4"	\$8.69	GO-2850000
354249	(905010) 1-1/2" NPT Hose ID 1-1/2"	\$9.19	GO-6160000

- Electronics
- Trolling Motors
- Instruments
- Electrical
- Lighting
- Anchor & Dock
- Safety
- Steering, Controls
- Pumps
- Fuel System
- Seating & Pedestals
- Trailering
- Tops & Covers
- Perform.
- Propellers
- Engine & Care
- Cleaning & Care
- Paint & Paint Acc.
- Fun & Flotation
- Topside Acc.
- Cockpit & Deck
- Hardware, Fasteners
- Camouflage
- Misc.
- Comm.

Marpac Stainless Steel Ball Valve



- 316 investment cast stainless steel.
- Bonding screw hole included.
- Tested to 1000 psi WOG. NPT threading.

Order No.	Description	List Price	
7-2240	3/4"	\$76.29	GO-1115000

Groco IBV Series Inline Ball Valves



- Female NPT threads.
- 1-1/4" sizes and larger include a grease zerk fitting for lubrication (use only with the valve in the open position) or for draining.
- Patented selectable handle rotation.
- Handle has square hole to accept standard ratchet to help reach valves in hard-to-reach locations and ease actuation of difficult to operate valves.
- 400 WOG rated.
- Full flow.
- C83600 bronze construction.
- Stainless steel handle and hardware.
- Chrome plated solid brass ball (not a hollow ball).
- PTFE seats and seals.
- Bonding attachment.
- UL listed 15PR for fuel or water.
- Fits IBVF for Seacock Application.



Order No.	Mfg. No. / Description	List Price	
375212	(IBV-0250) 1/4" NPT	\$23.09	GO-7451000
375229	(IBV-0375) 3/8" NPT	\$23.09	GO-7451000
375231	(IBV-0500) 1/2" NPT	\$32.39	GO-0712000
375242	(IBV-0750) 3/4" NPT	\$34.49	GO-1132000
375258	(IBV-1000) 1" NPT	\$68.39	GO-2854000
375268	(IBV-1250) 1-1/4" NPT	\$91.89	GO-7516000
375278	(IBV-1500) 1-1/2" NPT	\$130.49	GO-3478000
375281	(IBV-2000) 2" NPT	\$208.79	GO-9893100
375293	(IBV-2500) 2-1/2" NPT	\$341.99	GO-3192200
375306	(IBV-3000) 3" NPT	\$515.09	GO-1154300

Groco IBVF Series Flange Adaptors



- Eliminate dangerous thread miss-match when in-line valves (tapered NPT threads) are screwed onto thru-hulls (straight NPS threads).
- Accepts standard thru-hulls into the base and standard in-line valves on top.
- By spreading the load across a greater area IBVF provides a safer installation when in-line valves are used as seacocks.
- For OEMs, prevent valve damage during engine or generator installation - the valve can be installed later.
- Simplifies future valve replacement.
- C83600 Bronze and #316 SS models.



Order No.	Mfg. No. / Description	List Price	
375558	(IBVF-500) 1/2" Thread	\$44.99	GO-4103000
375560	(IBVF-750) 3/4" Thread	\$45.99	GO-1803000
375572	(IBVF-1000) 1" Thread	\$50.59	GO-0933000
375584	(IBVF-1250) 1-1/4" Thread	\$57.19	GO-2383000
375596	(IBVF-1500) 1-1/2" Thread	\$74.09	GO-4694000
375609	(IBVF-2000) 2" Thread	\$89.09	GO-9695000

Groco Three-Way Valves

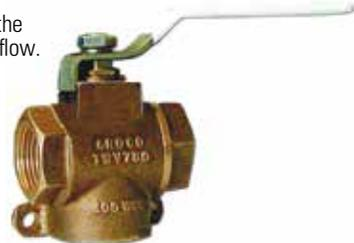

- 3-way valve operates logically - the handle points to the direction of flow.
- Center position is "off".
- Handle rotates a full 180°.
- Mount foot included.
- Full flow.
- PTFE seats and seals.
- Stainless steel handle and hardware.
- Use TWV-1500 (1-1/2" NPT ports) for waste systems.
- UL listed 15PR for fuel or water.

Order No.	Mfg. No. / Description	List Price	
375902	(TWV-500) 1/2" NPT	\$53.99	GO-7020000
376918	(TWV-750) 3/4" NPT	\$66.39	GO-8444000
375926	(TWV-1500) 1-1/2" NPT	\$221.19	GO-0284100

Groco IBV-S Series Stainless Inline Ball Valves



- 1-1/4" sizes and larger include a grease zerk fitting for lubrication (use only with the valve in the open position) or for draining.
- Handle has square hole to accept standard ratchet to help reach valves in hard-to-reach locations and ease actuation of difficult to operate valves.
- Thumb-release locking mechanism assures the valve remains in the position selected.
- 1000 WOG rated.
- Full flow.
- #316 stainless steel body.
- #304 stainless steel handle and trim.
- Bonding attachment.
- PTFE seats and seals.
- UL listed for 15PR fuel or water.
- Fits IBVF-S for Seacock Application.



Order No.	Mfg. No. / Description	List Price	
375346	(IBV-0250-S) 1/4" NPT	\$46.09	GO-8803000
375358	(IBV-0375-S) 3/8" NPT	\$50.59	GO-0933000
375368	(IBV-0500-S) 1/2" NPT	\$61.89	GO-7414000
375370	(IBV-0750-S) 3/4" NPT	\$65.29	GO-4734000
375382	(IBV-1000-S) 1" NPT	\$68.59	GO-2854000
375394	(IBV-1250-S) 1-1/4" NPT	\$109.09	GO-7516000
375407	(IBV-1500-S) 1-1/2" NPT	\$140.59	GO-0249000
375419	(IBV-2000-S) 2" NPT	\$149.99	GO-9400100
375421	(IBV-2500-S) 2-1/2" NPT	\$434.79	GO-3192200
375433	(IBV-3000-S) 3" NPT	\$642.69	GO-0603400

Groco FBV Series Full Flow Flanged Seacocks

GROCO.

- 1-1/4" sizes and larger include one grease zerk fitting for lubrication (use only with the valve in the open position), and one drain plug. The zerk can also be used for draining.
- Patented field reversible handle allows you to select the closed position orientation (clockwise or counter-clockwise) that best suits the installation.
- Handle has square hole to accept standard ratchet, to help reach valves in hard-to-reach locations and ease actuation of difficult to operate valves.
- Full flow.
- Triangular base with bolt pattern to match most popular brands makes retrofit easy.
- C83600 bronze construction.
- Stainless steel handle and hardware.
- Chrome plated solid brass ball.
- PTFE seats and seals.
- Bonding attachment on base.
- UL Listed 647-B.



Order No.	Mfg. No.	Bottom Connection	Top Connection	List Price	
312950	(FBV-0750)	3/4" NPS	3/4" NPT	\$72.09	G0-0384000
312962	(FBV-1000)	1" NPS	1" NPT	\$98.19	G0-9756000
312974	(FBV-1250)	1-1/4" NPS	1-1/4" NPT	\$122.19	G0-7818000
312986	(FBV-1500)	1-1/2" NPS	1-1/2" NPT	\$164.99	G0-4501100
312998	(FBV-2000)	2" NPS	2" NPT	\$268.29	G0-5797100
313001	(FBV-2500)	2-1/2" NPS	2-1/2" NPT	\$402.79	G0-7896200
313018	(FBV-3000)	3" NPS	3" NPT	\$541.99	G0-3136300

Groco CV Series In-line Check Valves

GROCO.

- May be used in water systems or fuel systems to keep pumps primed and to prevent back-flow.
- The unique design reduces flow turbulence and restriction, thus improving pump performance.
- C83600 cast bronze construction.
- NPT threaded ports.
- 1/2" - 2" sizes.
- Suitable for use with diesel fuel or gasoline.



Order No.	Mfg. No. / Description	List Price	
375751	(CV-50) 1/2" NPT	\$21.59	G0-7441000
375763	(CV-75) 3/4" NPT	\$25.29	G0-4961000
375774	(CV-100) 1" NPT	\$32.79	G0-7912000
375786	(CV-125) 1-1/4" NPT	\$59.99	G0-9104000
375798	(CV-150) 1-1/2" NPT	\$86.19	G0-5775000

Swing Check Valves

- Swing type disc.
- Screwed cap. Hard seat.
- 90° straight pattern.
- Used to prevent reverse flow in commercial and industrial applications.
- Integral seat.

Order No.	Mfg. No. / Description	List Price	
485573	(940-353) 3/4" NPT	\$32.79	G0-7912000
485585	(940-354) 1" NPT	\$46.99	G0-8413000

Groco BV Series Full Flow Flanged Ball Type Seacocks

GROCO.

- 1-1/4" sizes and larger include one grease zerk fitting for lubrication (use only with the valve in the open position), and one drain plug. The zerk can also be used for draining.
- Patented selectable handle rotation.
- Handle has square hole to accept standard ratchet to help reach valves in hard-to-reach locations and ease actuation of difficult to operate valves.
- Full flow.
- Tri-flange base and mount hole pattern provide easy retrofit when replacing most popular brands.
- C84400 bronze construction.
- Stainless steel ball and stem.
- PTFE seats and seals.
- Serviceable while installed. Base has bonding attachment.
- UL Listed 647B.



Order No.	Mfg. No.	Bottom Connection	Top Connection	List Price	
316011	(BV-0750)	3/4" NPS	3/4" NPT	\$212.69	G0-0524100
316023	(BV-1000)	1" NPS	1" NPT	\$253.89	G0-1107100
316035	(BV-1250)	1-1/4" NPS	1-1/4" NPT	\$319.49	G0-6041200
316047	(BV-1500)	1-1/2" NPS	1-1/2" NPT	\$365.39	G0-1844200
316059	(BV-2000)	2" NPS	2" NPT	\$465.49	G0-8811300
316061	(BV-2500)	2-1/2" NPS	2-1/2" NPT	\$716.89	G0-2308400
316073	(BV-3000)	3" NPS	3" NPT	\$1,134.59	G0-8106700
316085	(BV-4000)	4" NPS	4" NPT	\$2,450.69	G0-6914610

Groco Backing Blocks

GROCO.

- Each size fits multiple seacock sizes.
- Press threaded brass inserts into the hull side of the backing block into the holes that match the seacock flange.
- Rigid 1/2" thickness provides secure installation but is flexible enough to conform to minor hull curvature.
- Will not swell or absorb moisture.
- Made from an environmentally friendly PVC foam specially formulated for marine applications.



Order No.	Mfg. No.	Fits Seacock Sizes	Diameter	List Price	
316201	(BB-1)	750 and 1000	4.29	\$50.59	G0-0933000
316213	(BB-2)	1250 and 1500	5.38	\$60.99	G0-6804000
316225	(BB-3)	2000 and 2500	7.13	\$70.29	G0-9074000
316237	(BB-4)	3000	9.5	\$91.89	G0-7516000

- Electronics
- Trolling Motors
- Instruments
- Electrical
- Lighting
- Anchor & Dock
- Safety
- Steering, Controls
- Pumps
- Fuel System
- Seating & Pedestals
- Trailering
- Tops & Covers
- Perform.
- Propellers
- Engine & Care
- Cleaning & Care
- Paint & Paint Acc.
- Fun & Flotation
- Topside Acc.
- Cockpit & Deck
- Hardware, Fasteners
- Camouflage
- Misc.
- Comm.

Groco HTHC Series Thru-Hull Connectors

GROCO.



- 90° barb.
- Polished #316 stainless steel thru hull with bronze hose connection.
- Sizes to accept 3/4" to 1-3/4" ID hose.
- UL Listed 647B.

Order No.	Mfg. No.	Thread NPS	Hose ID	List Price	
256380	(HTHC-0750-S)	3/4"	3/4"	\$36.59	GO-2542000
256392	(HTHC-1000-S)	1"	1"	\$44.09	GO-4592000
256405	(HTHC-1250-S)	1-1/4"	1-1/4"	\$68.39	GO-2854000
256417	(HTHC-1500-S)	1-1/2"	1-1/2"	\$90.89	GO-0906000
256429	(HTHC-2000-S)	2"	1-3/4"	\$106.89	GO-2617000

Groco THXL Series Extra Long Thru-Hull Connectors

GROCO.



- Extra long NPSM thread for thick hull sections.
- C83600 Bronze.
- Includes nut.

Order No.	Mfg. No.	Pipe	Flange OD	Max. Hull Thickness	List Price	
256557	(THXL-0750-W)	3/4"	1.90"	5.33"	\$34.89	GO-8332000
256568	(THXL-1000-W)	1"	2.32"	5.33"	\$40.29	GO-9962000
256571	(THXL-1250-W)	1-1/4"	2.62"	5.45"	\$60.99	GO-6804000
256583	(THXL-1500-W)	1-1/2"	2.89"	5.45"	\$67.89	GO-9454000

Groco Thru-Hull Install Tool

GROCO.



- THT-530 makes the installation of standard GROCO thru-hull fittings possible by a single installer.
- Slide the thru-hull fitting, flanged end first, over the tool. (It will stop at the proper step.)
- Tie a length of monofilament to the eye and place it into the already-cut hole in the hull of the boat.
- Apply caulking to the flange of the fitting, and pull the fitting through the hole and against the hull from inside the boat.
- Thread the mono-filament through the locknut or seacock.
- With the fitting pulled firmly against the hull the locknut or the seacock may be screwed onto the fitting.
- THT-530 fits GROCO Thru-hull Fitting Sizes from 1/2" through 3".

Order No.	Mfg. No. / Description	List Price	
256407	(THT-530)	\$87.19	GO-2485000

Groco TH Series Thru-Hull Connectors

GROCO.



- NPS thread.
- C83600 Bronze.
- Includes nut.
- UL Listed 647B.

Order No.	Mfg. No. / Description		List Price	
256443	(TH-0500-W) Pipe 1/2"	Flange OD 1.70"	\$20.29	GO-9531000
256455	(TH-0750-W) Pipe 3/4"	Flange OD 1.90"	\$19.89	GO-3331000
256479	(TH-1000-W) Pipe 1"	Flange OD 2.32"	\$30.29	GO-9202000
256493	(TH-1250-W) Pipe 1-1/4"	Flange OD 2.62"	\$52.29	GO-3053000
256506	(TH-1500-W) Pipe 1-1/2"	Flange OD 2.89"	\$70.99	GO-6574000
256518	(TH-2000-W) Pipe 2"	Flange OD 3.33"	\$78.29	GO-5425000
256515	(TH-2500-W) Pipe 2-1/2"	Flange OD 4.4"	\$156.49	GO-5425000
256517	(TH-3000-W) Pipe 3"	Flange OD 5.5"	\$210.79	GO-3214100
256519	(TH-4000-W) Pipe 4"	Flange OD 7"	\$606.19	GO-5160400

Perko Thru-Hull Connectors

PERKO.



- Cast bronze.
- Flange is machined to fit hull and grooved to retain bedding compound.
- Neck is threaded to approximately 3/8" from flange.

Order No.	Mfg. No. / Description		List Price	
256520	(0322 010 PLB) Pipe 2-1/2"	Flange OD 4-1/2"	\$127.59	GO-9458000
256532	(0322 011 PLB) Pipe 3"	Flange OD 5"	\$229.09	GO-9435100

Marpac Stainless Steel Thru-Hull Connectors

marpac



- Stainless steel.
- Includes stainless steel nut.

Order No.	Hose ID	Flange OD	Overall Length	List Price	
7-0855	3/4"	1-3/4"	3-3/4"	\$25.49	GO-8071000
7-0856	1-1/8"	2-1/4"	4"	\$29.99	GO-9002000
7-0857	1-1/2"	3"	4-1/4"	\$39.59	GO-3562000

Marpac Thru-Hull Connectors

marpac



- All nylon thru-hull with stainless steel outside cover.
- Note: These thru-hulls for hose are not recommended for use below the waterline.

Order No.	Description	List Price	
7-0848	Hose ID 3/4"	\$8.79	GO-9850000
7-0850	Hose ID 1-1/8"	\$10.39	GO-6960000
7-0852	Hose ID 1-1/2"	\$11.69	GO-3870000

Marpac Thru-Hull Connectors



- High quality UV and chemical resistant engineered resin.
- Finished head for better appearance.
- Includes pass-around nut for easier installation.
- Note: These thru-hulls for hose are not recommended for use below the waterline.

WHITE

Order No.	Hose ID	Flange OD	Overall Length	List Price	
7-0357	1/2"	1-1/2"	1-1/4"	\$4.29	GO-7820000
7-0358	ID 5/8"	1-1/2"	1-1/4"	\$4.29	GO-7820000
7-0359	3/4"	1-7/8"	1-7/16"	\$4.29	GO-7820000
7-0360	1"	2-1/4"	1-1/2"	\$5.59	GO-5730000
7-0363	1-1/8"	2-1/4"	1-1/2"	\$6.59	GO-2440000
7-0365	1-1/2"	3"	1-7/8"	\$8.09	GO-2450000

BLACK

Order No.	Hose ID	Flange OD	Overall Length	List Price	
7-0354	3/4"	1-1/2"	3-1/16"	\$4.99	GO-4330000
7-0356	1-1/8"	1-7/8"	3-1/2"	\$7.09	GO-5740000

Forespar Thru-Hull Connectors - Plastic



- For connection to seacox, ball valves or hose.
- Molded in high strength glass reinforced "Marelon" for superior corrosion protection.
- For use above or below the waterline.
- Must be installed with proper bedding compound.

251 SERIES - FULL THREADED/MUSHROOM HEAD

Order No.	Mfg. No. / Description	Length	List Price	
353588	(906012) 3/4" Thread	Length 2-1/4"	\$19.39	GO-9921000
353589	(906014) 1" Thread	Length 2-3/8"	\$22.29	GO-3941000
353603	(906018) 1-1/2" Thread	Length 3"	\$33.19	GO-4222000

253 SERIES - HOSE TAILPIPE/MUSHROOM HEAD

Order No.	Mfg. No. / Description	List Price	
353639	(906022) Hose ID 1/2" - 5/8"	\$17.99	GO-5021000
353641	(906024) Hose ID 3/4"	\$19.39	GO-9921000
353653	(906026) Hose ID 1"	\$22.29	GO-3941000
353665	(906028) Hose ID 1-1/4"	\$26.99	GO-8081000
353677	(906030) Hose ID 1-1/2"	\$33.19	GO-4222000

T-H Marine Straight Thru-Hull Connectors - Plastic



- Made of the highest quality virgin material to insure consistent size and extra durability.

WHITE

Order No.	Mfg. No.	Flange Diameter	Length	Max. Hull Thickness	Hose ID	Package	List Price	
7001402	(TH-652-DP)	1-3/8"	3-3/8"	1-3/4"	5/8"	Package	\$4.89	HO-3920000
6400324	(TH-752-B)	1-3/8"	3-1/16"	1-3/4"	3/4"	Bulk	\$2.69	HO-1610000
7001406	(TH-752-DP)	1-3/8"	3-1/16"	1-3/4"	3/4"	Package	\$6.59	HO-5930000
6400298	(TH-1202-B)	1-7/8"	3-1/2"	1-3/4"	1-1/8"	Bulk	\$4.69	HO-1820000
7001398	(TH-1202-DP)	1-7/8"	3-1/2"	1-3/4"	1-1/8"	Package	\$6.89	HO-3140000
641414	(TH-1502-DP)	2-7/8"	3-1/2"	1-5/8"	1-1/2"	Package	\$15.59	HO-5390000
6400327	(TH-752XL-B)	1-3/8"	4-1/2"	3"	3/4"	Bulk	\$3.79	HO-7220000
642024	(TH-752XL-DP)	1-3/8"	4-1/2"	3"	3/4"	Package	\$6.49	HO-9830000
6400300	(TH-1202XL-B)	1-7/8"	5-3/8"	3-3/8"	1-1/8"	Bulk	\$5.29	HO-7130000
642062	(TH-1202XL-DP)	1-7/8"	5-3/8"	3-3/8"	1-1/8"	Package	\$8.69	HO-1250000
641427	(TH-1502XL-DP)	2-7/8"	5-3/8"	3-1/4"	1-1/2"	Package	\$13.69	HO-1280000

BLACK

Order No.	Mfg. No.	Flange Diameter	Length	Max. Hull Thickness	Hose ID	Package	List Price	
7001404	(TH-750-B)	1-3/8"	3-1/16"	1-3/4"	3/4"	Bulk	\$2.59	HO-5510000
640980	(TH-750-DP)	1-3/8"	3-1/16"	1-3/4"	3/4"	Package	\$4.39	HO-3620000
6400293	(TH-1200-B)	1-7/8"	3-1/2"	1-3/4"	1-1/8"	Bulk	\$4.39	HO-3620000
7001396	(TH-1200-DP)	1-7/8"	3-1/2"	1-3/4"	1-1/8"	Package	\$6.39	HO-3830000
6400308	(TH-1500-DP)	2-7/8"	3-1/2"	1-5/8"	1-1/2"	Package	\$9.49	HO-9650000
6400322	(TH-750XL-B)	1-3/8"	4-1/2"	3"	3/4"	Bulk	\$3.69	HO-1220000
6400323	(TH-750XL-DP)	1-3/8"	4-1/2"	3"	3/4"	Package	\$6.49	HO-9830000
6400296	(TH-1200XL-B)	1-7/8"	5-3/8"	3-3/8"	1-1/8"	Bulk	\$5.09	HO-5030000
6400297	(TH-1200XL-DP)	1-7/8"	5-3/8"	3-3/8"	1-1/8"	Package	\$8.99	HO-9350000

CHROME PLATED

Order No.	Mfg. No.	Flange Diameter	Length	Max. Hull Thickness	Hose ID	Package	List Price	
6400319	(TH-750CP-DP)	1-3/8"	3-1/16"	1-3/4"	3/4"	Package	\$7.29	HO-7340000
6400294	(TH-1200CP-DP)	1-7/8"	3-1/2"	1-3/4"	1-1/8"	Package	\$9.49	HO-9650000



- Electronics
- Trolling Motors
- Instruments
- Electrical
- Lighting
- Anchor & Dock
- Safety
- Steering, Controls
- Pumps
- Fuel System
- Seating & Pedestals
- Trailer
- Tops & Covers
- Perform.
- Propellers
- Engine & Care
- Cleaning & Care
- Paint & Paint Acc.
- Fun & Flotation
- Topside Acc.
- Cockpit & Deck
- Hardware, Fasteners
- Camouflage
- Misc.
- Comm.

T-H Marine 90° Thru-Hull Connectors - Plastic

- Electronics
- Trolling Motors
- Instruments
- Electrical
- Lighting
- Anchor & Dock
- Safety
- Steering, Controls
- Pumps**
- Fuel System
- Seating & Pedestals
- Trailering
- Tops & Covers
- Perform.
- Propellers
- Engine & Care
- Cleaning & Care
- Paint & Paint Acc.
- Fun & Flotation
- Topside Acc.
- Cockpit & Deck
- Hardware, Fasteners
- Camouflage
- Misc.
- Comm.



7001400



6400337



6400329

- Made of the highest quality virgin material to insure consistent size and extra durability.
- Our standard 90° fittings feature a unique finished head and a pass-around nut for easier and more attractive installation.
- **6400334** (TH-90-B) and **6400337** (TH-92-DP) - Features two nuts.

WHITE

Order No.	Mfg. No.	Flange Diameter	Length	Max. Hull Thickness	Hose ID		List Price	
6400332	(TH-7592-B)	1-3/8"	2-1/2"	1"	3/4"	Bulk	\$3.79	HO-7220000
7001408	(TH-7592-DP)	1-3/8"	2-1/2"	1"	3/4"	Package	\$5.89	HO-3530000
7001400	(TH-1292-DP)	1-7/8"	3-1/2"	1-1/8"	1-1/8"	Package	\$11.69	HO-1070000
642192	(TH-1592-DP)	2-7/8"	4-1/4"	1-5/8"	1-1/2"	Package	\$17.99	HO-9701000

BLACK

Order No.	Mfg. No.	Flange Diameter	Length	Max. Hull Thickness	Hose ID		List Price	
6400329	(TH-7590-B)	1-3/8"	2-1/2"	1"	3/4"	Bulk	\$3.69	HO-1220000
6400330	(TH-7590-DP)	1-3/8"	2-1/2"	1"	3/4"	Package	\$5.79	HO-7430000
6400303	(TH-1290-DP)	1-7/8"	3-1/2"	1-1/8"	1-1/8"	Package	\$12.99	HO-9770000
6400334	(TH-90-B)	1-5/8"	2-5/8"	7/8"	3/4"	Bulk	\$3.39	HO-3020000

Marpac 90° Thru-Hull Connectors



- High quality UV and chemical resistant engineered resin.
- Finished head for better appearance.
- Includes pass-around nut for easier installation.
- Note: These thru-hulls for hose are not recommended for use below the waterline.

FITS 3/4" HOSE. THREAD LENGTH: 1"

- Flange size: 1-1/2", overall length: 2-1/2", shaft diameter 1".

Order No.	Description	List Price	
7-0362	White	\$5.39	GO-1630000
7-0366	Black	\$5.39	GO-1630000

FITS 1-1/8" HOSE. THREAD LENGTH: 1-1/8"

- Flange size: 1-7/8", overall length: 3-1/2", shaft diameter 1-3/8".

Order No.	Description	List Price	
7-0364	White	\$7.99	GO-5350000
7-0367	Black	\$9.69	GO-9460000

Attwood Thru-Hull with Strainer



- Acetal construction.
- Thru-hull connector with strainer prevents clogging of the aerator pump.
- Strainer attaches to threads that extend beyond external retaining nut.
- Hose ID 3/4".
- Maximum hull thickness: 1-7/16".
- Installation hole size: 1-1/16" to 1-1/8".
- Caution: Do not use strainer as a thru-hull connector nut replacement.
- Thru-hull connectors are designed for installation above the water line only.

Order No.	Mfg. No. / Description	List Price
2350061	(3886-3) White	\$14.89

Attwood Double-Ended Thru-Hull Connector



- Polypropylene construction.
- Double-ended thru-hull provides watertight transition through bulkheads or tanks.
- Overall length 5".
- Fits hose size: 3/4" ID.
- Maximum hull thickness: 1-1/8".
- Caution: Thru-hull connectors are designed for installation above the water line only.

Order No.	Mfg. No. / Description	List Price
2350059	(3878-3) White	\$12.99

Buck-Algonquin "Tuff-Lite" Nylon Tees



• Sold each.

Order No.	Mfg. No. / Description	List Price	
354617	(60TSS222) Tube ID 1/4"	\$1.59	G0-7010000
354629	(60TSS333) Tube ID 3/8"	\$1.39	G0-3900000
354631	(60TSS444) Tube ID 1/2"	\$1.49	G0-0010000

T-H Marine Standard Tee Fittings



- Molded specifically to fit marine hose dimensions.
- Standard tees all have the same barb dimension for each leg of the tee.
- 3-way barbed tee.

Order No.	Mfg. No. / Description	List Price	
641375	(TEE-3/4-DP) Hose 3/4" ID	\$4.79	H0-7820000
6400288	(TEE-118-DP) Hose 1-1/8" ID	\$7.49	H0-9440000

SeaTech PEX Tubing



- Lead free.
- Produced from high performance, cross-linked Polyethylene material.
- Sea Tech tubing is NSF listed, FDA recognized and available in multiple colors for ease of waterline identification.
- Operating pressure: Vacuum to 160 psi.
- Fitting performance ratings: 100 psi @ 140° F, 250 psi @ 75° F.
- Length 50' coil.

Order No.	Mfg. No.	Tube Size	Color	List Price	
779000	(81902022)	15MM	White	\$60.49	L0-5203000
779005	(81902021)	15MM	Red	\$60.49	L0-5203000
779010	(81902019)	15MM	Blue	\$60.49	L0-5203000
779015	(81903233)	22MM	White	\$108.29	L0-5145000
779020	(81903236)	22MM	Red	\$108.29	L0-5145000
779025	(81903239)	22MM	Blue	\$108.29	L0-5145000

Marpac Bilge Pump Plumbing Kit



- Complete the installation of your bilge pump with ease using this plumbing kit.
- Kit includes: Plastic bilge hose, thru-hull fitting and (2) stainless steel clamps.

Order No.	Mfg. No. / Description	List Price	
7-57304	(57304) 3/4" x 5'	\$11.69	G0-3870000

SeaTech PEX Tubing Cutter



Order No.	Mfg. No. / Description	List Price	
779030	(81902459) PEX Tubing Cutter	\$27.29	H0-7361000
779035	(81902462) Replacement Blade	\$8.49	H0-9050000

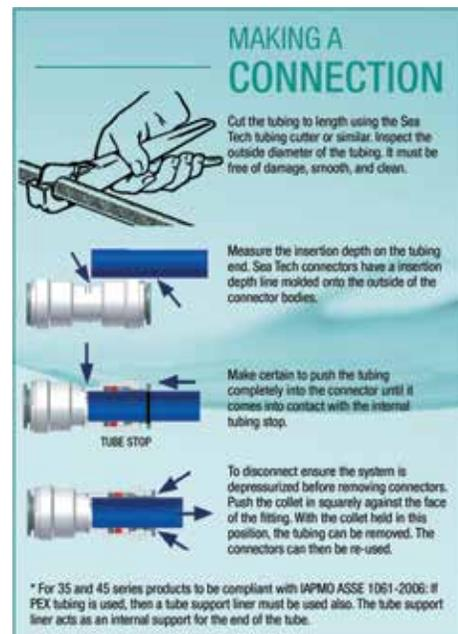

- Electronics
- Trolling Motors
- Instruments
- Electrical
- Lighting
- Anchor & Dock
- Safety
- Steering, Controls
- Pumps**
- Fuel System
- Seating & Pedestals
- Trailer
- Tops & Covers
- Perform.
- Propellers
- Engine & Care
- Cleaning & Care
- Paint & Paint Acc.
- Fun & Flotation
- Topside Acc.
- Cockpit & Deck
- Hardware, Fasteners
- Camouflage
- Misc.
- Comm.

- Electronics
- Trolling Motors
- Instruments
- Electrical
- Lighting
- Anchor & Dock
- Safety
- Steering, Controls
- Pumps**
- Fuel System
- Seating & Pedestals
- Trailer
- Tops & Covers
- Perform.
- Propellers
- Engine & Care
- Cleaning & Care
- Paint & Paint Acc.
- Fun & Flotation
- Topside Acc.
- Cockpit & Deck
- Hardware, Fasteners
- Camouflage
- Misc.
- Comm.

SeaTech Union Tee



Order No.	Mfg. No.	Tube Size	List Price
779190	(81902439)	15MM	\$9.09 HO-5450000
779195	(81902644)	22MM	\$18.29 HO-7901000

SeaTech Reducing Tee



Order No.	Mfg. No.	Tube Size	List Price
779070	(81902650)	22MM x 22MM x 15MM	\$19.49 HO-9611000
779075	(81902648)	22MM x 15MM x 15MM	\$19.49 HO-9611000

SeaTech Stackable Tee



Order No.	Mfg. No.	Tube Size	List Price
779160	(81902447)	15MM	\$8.49 HO-9050000

SeaTech Union Elbow



Order No.	Mfg. No.	Tube Size	List Price
779180	(81902424)	15MM	\$6.19 HO-1730000
779185	(81902640)	22MM	\$12.99 HO-9770000

SeaTech Female Swivel Elbow



Order No.	Mfg. No.	Tube Size	Thread Size	List Price
779130	(81902431)	15MM	1/2" NPS	\$8.49 HO-9050000
779135	(81902433)	22MM	3/4" NPS	\$14.09 HO-5480000

SeaTech Stackable Elbow



Order No.	Mfg. No.	Tube Size	List Price
779060	(81902426)	15MM	\$7.39 HO-3440000
779065	(81902642)	22MM	\$16.59 HO-5990000

SeaTech Union Connector



Order No.	Mfg. No.	Tube Size	List Price
779200	(81902418)	15MM	\$6.19 HO-1730000
779205	(81902638)	22MM	\$12.09 HO-5270000

SeaTech Reducing Union



Order No.	Mfg. No.	Tube Size	List Price
779050	(81902422)	15MM x 1/4" OD	\$7.39 HO-3440000

SeaTech Hose Barb Connector



Order No.	Mfg. No.	Tube Size	Thread Size	List Price
779150	(81902402)	15MM	1/2" NPS	\$7.09 HO-5240000
779155	(81902404)	15MM	3/4" NPS	\$11.89 HO-3170000

SeaTech Male Elbow



Order No.	Mfg. No.	Tube Size	Thread Size	List Price	
779140	(81902428)	15MM	1/2" NPT	\$9.09	HO-5450000

SeaTech Hose Barb Connector



Order No.	Mfg. No.	Tube Size	Thread Size	List Price	
779040	(81902778)	15MM	1/2" H.B.	\$9.89	HO-3950000
779045	(81902839)	22MM	3/4" H.B.	\$10.99	HO-9560000

SeaTech End Stop



Order No.	Mfg. No.	Tube Size	List Price	
779110	(81902452)	15MM	\$6.49	HO-9830000
779115	(81902652)	22MM	\$8.49	HO-9050000

SeaTech Male Pipe Stem



Order No.	Mfg. No. / Description	List Price	
779165	(81902697) 15MM x 3/8"	\$4.79	HO-7820000

SeaTech Elbow Clip



Order No.	Mfg. No. / Description	List Price	
779145	(81902747) 15MM	\$3.69	HO-1220000

SeaTech Pipe Clips



Order No.	Mfg. No. / Description	List Price	
779120	(81902750) 15MM	\$0.59	HO-5300000
779125	(81902751) 22MM	\$0.59	HO-5300000

SeaTech Elbow Pump Connector



Order No.	Mfg. No.	Tube Size	List Price	
779175	(81902812)	15MM	\$6.49	HO-9830000

SeaTech Union Pump Connector



Order No.	Mfg. No.	Tube Size	List Price	
779170	(81902811)	15MM	\$6.49	HO-9830000

SeaTech Stop Valve



Order No.	Mfg. No.	Tube Size	List Price	
779090	(81902801)	15MM	\$25.59	HO-9830000
779095	(81902841)	22MM	\$30.99	HO-9581000

SeaTech Male Connector



- 24 Series fittings are manufactured from acetal for general plumbing use.
- These fittings interconnect with Sea Tech's 35 Series connections.

Order No.	Mfg. No. / Description	List Price	
779085	(81902766) 1/2" CTS x 1/2" NPT	\$5.99	HO-9530000

SeaTech Collect Clips



Order No.	Mfg. No. / Description	List Price	
779100	(81902457) 15MM	\$0.49	HO-9200000
779105	(81902458) 22MM	\$0.49	HO-9200000

- Electronics
- Trolling Motors
- Instruments
- Electrical
- Lighting
- Anchor & Dock
- Safety
- Steering, Controls
- Pumps**
- Fuel System
- Seating & Pedestals
- Trailer
- Tops & Covers
- Perform.
- Propellers
- Engine & Care
- Cleaning & Care
- Paint & Paint Acc.
- Fun & Flotation
- Topside Acc.
- Cockpit & Deck
- Hardware, Fasteners
- Camouflage
- Misc.
- Comm.

Perko Fig. 709 Pump Strainer



- Cast bronze.
- Hose 5/8".
- Length overall 3-5/8".
- Width overall 1-3/4".

Order No.	Mfg. No. / Description	List Price
541727	(0709 DPO PLB)	\$59.39 GO-9793000

Buck-Algonquin Navy Pump Strainers



- Complete with screens.
- Dimensions: 3-1/2" W x 5" L x 2" H.

Order No.	Mfg. No. / Description	List Price
256873	(20NPSB150) Aluminum For 1-1/2" Nipple	\$100.49 GO-3376000
256885	(20NPSB200) Aluminum For 2" Nipple	\$102.69 GO-0886000
256900	(00NPS200) Bronze For 2" Nipple	\$189.89 GO-3272100

Buck-Algonquin Positive Flow Rectangular Scoop Strainers

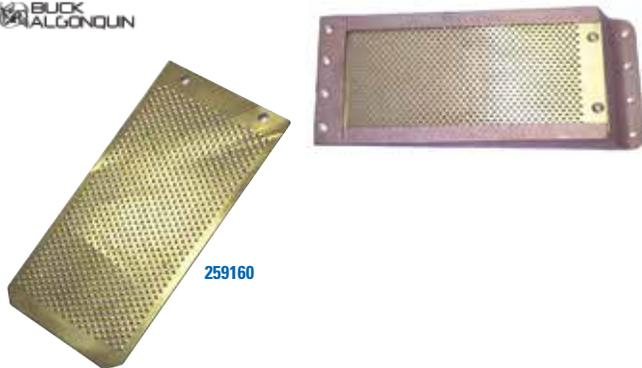

- Bronze.
- Slide out screens.
- Complete with brass positive flow screens.
- Holes are drilled 1/8" on a 45° angle.

Order No.	Mfg. No.	Dimensions (L x W)	Max. Thru Hull	List Price
259122	(00RSS655PF)	10-5/16" x 4-5/8"	2"	\$200.09 GO-6043100
259134	(00RSS110PF)	12-3/4" x 5-7/8"	3"	\$282.79 GO-7498100
259146	(2352PF)	13-15/16" x 7-1/16"	4"	\$399.49 GO-6676200

SCREEN ONLY

Order No.	Mfg. No. / Description	List Price
259160	(00RSS655PFS) Screen Only for 259122	\$85.59 GO-5375000
259172	(00RSS110PFS) Screen Only for 259134	\$46.98 GO-8413000
259184	(2352SPF) Screen Only for 259146	\$150.49 GO-3800100

Perko Fig. 722 Pump Strainer



- Cast bronze.
- Pipe 1-1/4".
- Length overall 4-1/2". Width overall 2-3/4".

Order No.	Mfg. No. / Description	List Price
541791	(0722 000 PLB)	\$127.29 GO-8258000

Buck-Algonquin Rectangular Scoop Strainers - Slide Out Screens

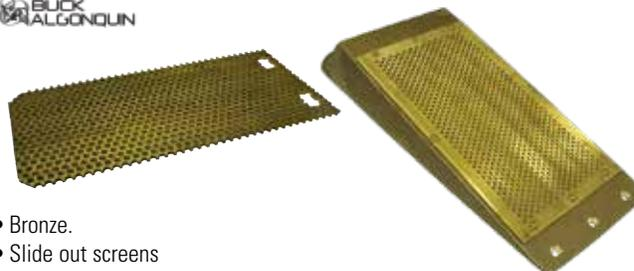

- Bronze.
- Slide out screens
- Complete with perforated screens.

Order No.	Mfg. No.	Dimensions	Max. Thru Hull	List Price
259033	(2349)	6-5/8" L x 3-3/4" W	1-1/4"	\$102.59 GO-4786000
259045	(00RSS655P)	10-5/16" L x 4-5/8" W	2"	\$194.19 GO-1103100
259057	(00RSS1100P)	12-3/4" L x 5-7/8" W	3"	\$256.49 GO-5817100
259069	(2352)	13-15/16" L x 7-1/16" W	4"	\$371.29 GO-6784200
259071	(2349-S)	Screen Only for 259033		\$28.19 GO-9881000
259083	(00RSS655PS)	Screen Only for 259045		\$45.99 GO-1803000
259095	(00RSS110PS)	Screen Only for 259057		\$46.19 GO-5903000
259108	(2352-S)	Screen Only for 259069		\$63.79 GO-4724000

Buck-Algonquin Rectangular Scoop Strainers - Surface Mount Screens



- Stainless steel.
- Surface mount screens.
- Complete with stainless steel perforated screen.

Order No.	Mfg. No.	Dimensions	Max. Thru Hull	List Price
259007	(00RSS650P)	10" L x 4-1/2" W	2"	\$137.29 GO-8919000
259019	(00RSS1000P)	13-7/8" L x 6" W	3"	\$162.79 GO-7090100

Sen-Dure Water Strainer



- Bronze.
- For seacock inlets up to 2-1/2".
- Overall size: 15" L x 5-7/8" W.

Order No.	Mfg. No. / Description	List Price
605014	(0910)	\$356.98 EO-4776200

- Electronics
- Trolling Motors
- Instruments
- Electrical
- Lighting
- Anchor & Dock
- Safety
- Steering, Controls
- Pumps
- Fuel System
- Seating & Pedestals
- Trailer
- Tops & Covers
- Perform.
- Propellers
- Engine & Care
- Cleaning & Care
- Paint & Paint Acc.
- Fun & Flotation
- Topside Acc.
- Cockpit & Deck
- Hardware, Fasteners
- Camouflage
- Misc.
- Comm.

Groco ASC Series Hull Strainers

GROCO.



- Patented access door design allows easy access to thru hulls.
- There is no need to remove the entire strainer to clear nuisance marine growth.
- C84400 bronze body and door.
- Cast filter slots.
- Pressure relief holes in door casting.



Order No.	Mfg. No.	Max. T-Hull	Dimensions	List Price	
376726	(ASC-2000)	2"	10.25" x 4.38" x 1.63"	\$209.19	GO-6104100
376738	(ASC-3000)	3"	15.38" x 6" x 2"	\$379.99	GO-9545200

Groco STH Series Scoop Strainers

GROCO.

- Induces positive pressure while underway.
- NPS thread.
- C83600 Bronze.



Order No.	Mfg. No. / Description		List Price	
256734	(STH-0500-W) Thread 1/2" NPS		\$26.29	GO-1671000
256746	(STH-0750-W) Thread 3/4" NPS		\$31.39	GO-3012000
256758	(STH-1000-W) Thread 1" NPS		\$39.19	GO-6262000
256772	(STH-1250-W) Thread 1-1/4" NPS		\$56.59	GO-2973000

Groco SC Series Hull Strainers

GROCO.



- C83600 bronze body and ring.
- Cast filter slots.
- Access to the thru-hull fitting and seacock inlet beneath Groco SC Series hull strainers is simplified by the exclusive mount ring design. The mount ring is permanently attached to the hull - the strainer attaches to the ring.



STANDARD FLOW

Order No.	Mfg. No.	Max. Thru-Hull	Mount Ring Included	List Price	
376663	(SC-1000)	1"	Yes	\$51.79	GO-0743000
376601	(SC-1000-L)	1"	No	\$31.49	GO-0112000
376675	(SC-1500)	1-1/2"	Yes	\$111.39	GO-3647000
376613	(SC-1500-L)	1-1/2"	No	\$56.29	GO-1773000
376687	(SC-2500)	2-1/2"	Yes	\$148.49	GO-9499000
376625	(SC-2500-L)	2-1/2"	No	\$89.79	GO-6106000

HI-FLOW

Order No.	Mfg. No.	Max. Thru-Hull	Mount Ring Included	List Price	
376699	(SC-4300)	4"	Yes	\$336.19	GO-5252200
376637	(SC-4300-L)	4"	No	\$200.19	GO-3143100

Perko Fig. 66 Scoop Strainers



- Cast bronze.
- Machine slots.
- Uses #8 fasteners.

Order No.	Mfg. No.	For Thru-Hull Sizes	Dimensions	List Price	
542630	(0066 DP2 PLB)	3/4" & 1"	5" x 3-1/4"	\$40.79	GO-3372000
542642	(0066 DP3 PLB)	1-1/4" & 1-1/2"	6-1/4" x 4-1/4"	\$53.69	GO-2020202

Groco APHS Series Hull Strainers

GROCO.



- Patented access door design allows easy access to thru hulls.
- C84400 bronze body and door.
- There is no need to remove the entire strainer to clear nuisance marine growth.
- #304 stainless steel filter screen available with .077", .125" and .188" perforated diameters.
- Easy field replaceable screen. Pressure relief holes in door casting.



Order No.	Mfg. No.	Max. T-Hull	Dimensions	List Price	
376776	(APHS-1250-1)	1-1/4"	7" x 3.38" x 1.5"	\$168.69	GO-2031100
376788	(APHS-2000-1)	2"	10.25" x 4.38" x 1.63"	\$230.49	GO-3445100
376790	(APHS-3000-1)	3"	15.38" x 6" x 2"	\$406.99	GO-8627200

Buck-Algonquin Bronze Intake Strainers



- Bronze.
- Oval base.
- Thru hull style.
- Complete with flange nut.
- Stern length: 3-1/2".
- Uses #10 fasteners.



Order No.	Mfg. No. / Description	List Price	
256784	(00IS150) Thread 1-1/2" NPS	\$177.89	GO-9191100
256785	(00IS200) Thread 2" NPS	\$195.99	GO-1313100

Groco RSC Series Hull Strainers

GROCO.



- Ideal for sailboats and generators by providing coarse primary filtration without exerting excess pressure to cooling lines which can flood engines that are not operating.
- Patented access door design allows easy access to thru hulls.
- There is no need to remove the entire strainer to clear nuisance marine growth.
- C84400 bronze body and door. Cast filter holes.
- Designed for systems where forced flow is not needed or wanted.



Order No.	Mfg. No.	Max. Thru-Hull		List Price	
376500	(RSC-1000)	1"	Dia: 3.63" .56" H	\$69.79	GO-6764000
376512	(RSC-2000)	1"	Dia: 5.2" .83" H	\$104.59	GO-8007000

Perko Fig. 86 Round Strainers



- Cast bronze.
- Drilled holes.



Order No.	Mfg. No.	OD	For Thru-Hull Size	List Price	
542678	(0086 DP2 PLB)	3"	3/4"	\$19.59	GO-3131000
542680	(0086 DP3 PLB)	3-1/2"	1"	\$20.99	GO-6041000
542692	(0086 DP4 PLB)	4"	1-1/4" and 1-1/2"	\$27.49	GO-2481000
542705	(0086 DP5 PLB)	5"	2"	\$52.69	GO-0353000
542717	(0086 006 PLB)	6"	2-1/2"	\$71.79	GO-0184000

- Electronics
- Trolling Motors
- Instruments
- Electrical
- Lighting
- Anchor & Dock
- Safety
- Steering, Controls
- Pumps
- Fuel System
- Seating & Pedestals
- Trailering
- Tops & Covers
- Perform.
- Propellers
- Engine & Care
- Cleaning & Care
- Paint & Paint Acc.
- Fun & Flotation
- Topside Acc.
- Cockpit & Deck
- Hardware, Fasteners
- Camouflage
- Misc.
- Comm.

Groco BS Series Bilge Strainers



- C84400 bronze.
- Provides coarse filtration and prevent large debris in the bilge from entering bilge pumps.
- Drilled top holes, cast side slots.
- Mounting ears.
- The NPT thread is for use with straight, 45° or 90° bronze pipe to hose adaptors.

Order No.	Mfg. No.	Thread NPT	Dimensions	List Price	
376916	(BS-2000)	2"	5.25" x 3.63" x 2"	\$243.59	GO-1236100
376928	(BS-3000)	3"	5.25" x 3.63" x 2"	\$246.39	GO-8056100

Forespar Water Strainer



- Molded in high strength glass reinforced "Marelon" for superior corrosion protection.
- It features an integral mounting bracket and clear polycarbonate lid for ready inspection.
- Intake and exit ports are 1-1/2" threads standard.
- The flow rate is 40 GPM.

Order No.	Mfg. No. / Description	List Price	
353401	(906066) Diameter 6.3", Height 6.1"	\$190.49	GO-3672100

Shurflo Raw Water Strainers



- Built to keep bait tank, livewell and washdown pumps protected from harmful debris.
- Features a clear twist off bowl and removable stainless steel screen, which allows for easy inspection and cleaning.
- Screen: Mesh T304 SS.

Order No.	Mfg. No. / Description	List Price	
375190	(253-220-01) Inlet/Outlet Ports: 3/4" NPT-F	\$39.29	GO-2362000
375205	(253-400-01) Inlet/Outlet Ports: 1-1/4" NPT-F	\$66.09	GO-8244000

Jabco "Pumpgard" In-Line Strainers



- Prevents dirt and particles from entering pump intake, cuts repairs.
- Transparent inspection housing.
- Just remove one screw for easy cleaning.

Order No.	Mfg. No. / Description	List Price	
414754	(36400-0000) 1/2" ID hose, 50 Mesh Screen	\$27.39	GO-5381000
414350	(36200-0000) 3/4" ID hose, 16 Mesh Screen	\$27.39	GO-5381000

Whale Polypropylene Strainers



- Whale Strainers are ideal for use in bilge systems.
- They prevent large debris for entering the hose which could damage pumps and include a non-return valve to prevent drain back.
- Top Entry Strainers ideal for deeper bilges and Side Entry Strainers suitable for more shallow bilge spaces.
- The strainers are easily cleaned with a removable cover and have a stepped outlet port suitable for either 1" or 1-1/2" hose connections.

Order No.	Mfg. No. / Description	List Price	
587512	(SB4222) Side Entry	\$30.89	F0-2612000
587513	(SB5865) Top Entry	\$30.89	F0-2612000

Buck-Algonquin Bronze Intake Water Strainer Accessories



- Replacement kit includes: Dome lid, lid gasket, spacer, O-ring, washer, center bolt and nut.

Order No.	Mfg. No. / Description	List Price	
257217	(D01WS1215KIT) Replacement Kit	\$64.49	GO-1234000
257229	(C01WS1215G) Replacement Lid Gasket	\$9.49	GO-6360000
257245	(701WS1215R) Screen Only	\$15.49	GO-8301000

Buck-Algonquin Black Polyethylene Strainers



- Black polyethylene.

Order No.	Mfg. No.	Thread Size	List Price	
256722	(60TSS25)	2"	\$16.99	GO-8311000
256735	(60TSS35)	3"	\$25.59	GO-5171000

Groco WSB Series Fresh Water Strainers



- Protect fresh water pumps from debris.
- White nylon strainer head and clear plastic sight glass.
- Mount bracket included.
- For fresh water systems.



Order No.	Mfg. No. / Description	
S/O	(WSB-500) Thread 1/2" NPT	
S/O	(WSB-750) Thread 3/4" NPT	
S/O	(WSB-1000) Thread 1" NPT	
S/O	(WSB-1250) Thread 1-1/4" NPT	

Johnson Pump PUMProtector Universal Strainers



- Transparent covers for simple inspection.
- Easy to install and remove for thorough cleaning thanks to KlickTite port connectors.
- Diameter 3.15". Height 2.35".
- 2x 1/2" barb/3/8" NPT. 2x 3/4" barb/1/2" NPT.

Order No.	Mfg. No. / Description	List Price	
471374	(092465202CN) Stainless Steel 40 mesh	\$19.79	GO-6231000
462334	(09-2465204CN) Stainless Steel 20 mesh	\$18.69	GO-2521000

- Electronics
- Trolling Motors
- Instruments
- Electrical
- Lighting
- Anchor & Dock
- Safety
- Steering, Controls
- Pumps
- Fuel System
- Seating & Pedestals
- Trailering
- Tops & Covers
- Perform.
- Propellers
- Engine & Care
- Cleaning & Care
- Paint & Paint Acc.
- Fun & Flotation
- Topside Acc.
- Cockpit & Deck
- Hardware, Fasteners
- Camouflage
- Misc.
- Comm.



Perko Fig. 493 Intake Water Strainers



- Cast bronze with 316 stainless steel bracket and clear polymer cylinder.
- Designed for easy installation and cleaning.
- Mounting lugs cast into both sides to assure universal mounting.
- Four outside tie rods.
- Stainless steel strainer basket minimizes electrolysis.
- .079" screen hole diameter provides 47% open area.
- Hinged lugs on cover permit easy removal and cleaning of the strainer basket.
- A drain plug in the bottom casting is provided for easily removing sediment and draining for winterizing.
- Tested and accepted for labeling and UL listed.

Order No.	Mfg. No.	Pipe Size	Height Overall	Width Overall	Cylinder Dimensions	Basket Dimensions	List Price	
538946	(0493 004 PLB)	1/2"	5-3/4"	4-1/2"	3-1/2" x 4"	1-13/16" x 4-1/16"	\$268.99	GO-2208100
538958	(0493 005 PLB)	3/4"	8-3/8"	4-1/2"	3-1/2" x 6"	1-13/16" x 6-1/4"	\$282.99	GO-0698100
538960	(0493 006 PLB)	1"	9-1/2"	5-1/2"	4-1/2" x 5-1/2"	2-5/8" x 5-7/8"	\$406.99	GO-8627200
538972	(0493 007 PLB)	1-1/4"	10"	5-1/2"	4-1/2" x 6"	2-5/8" x 6-1/4"	\$411.19	GO-0557200
538984	(0493 008 PLB)	1-1/2"	11-1/2"	7-1/4"	6" x 8"	3-5/16" x 8-7/16"	\$630.09	GO-6122400
538996	(0493 009 PLB)	2"	16"	7-1/2"	6" x 12"	3-5/16" x 12-1/4"	\$781.59	GO-7632500
539001	(0493 010 PLB)	2-1/2"	16"	7-1/2"	6" x 12"	3-5/16" x 12-1/2"	\$787.59	E0-9609500

SPARE PARTS

Order No.	Mfg. No. / Description	List Price	Order No.	Mfg. No. / Description	List Price
539025	(0493 004 99C) (99C) Transparent Cyl. Only	\$63.99	539377	(0493 DP5 99L) (99L) Hinged Bolt for Cover with Pin, Nut and Washer	\$27.49
539037	(0493 005 99C) (99C) Transparent Cyl. Only	\$73.89	539378	(0493 DP7 99L) (99L) Hinged Bolt for Cover	\$30.69
539049	(0493 006 99C) (99C) Transparent Cyl. Only	\$94.39	539379	(0493 DP9 99L) (99L) Hinged Bolt for Cover	\$38.99
539051	(0493 007 99C) (99C) Transparent Cyl. Only	\$94.39	539291	(0493 DP5 99M) (99M) Cork Gasket Kit	\$19.59
539063	(0493 008 99C) (99C) Transparent Cyl. Only	\$133.69	539316	(0493 DP7 99M) (99M) Cork Gasket Kit	\$23.59
539075	(0493 010 99C) (99C) Transparent Cyl. Only	\$166.49	539328	(0493 DP9 99M) (99M) Cork Gasket Kit	\$33.79
539087	(0493 004 99D) (99D) Basket Strainer	\$60.19	539295	(0493 DP5 99R) (99R) Rubber Gasket Kit	\$19.89
539095	(0493 005 99D) (99D) Basket Strainer	\$70.09	539300	(0493 DP7 99R) (99R) Rubber Gasket Kit	\$23.99
539102	(0493 006 99D) (99D) Basket Strainer	\$88.79	539330	(0493 DP9 99R) (99R) Rubber Gasket Kit	\$34.19
539114	(0493 007 99D) (99D) Basket Strainer	\$100.19			
539126	(0493 008 99D) (99D) Basket Strainer	\$133.39			
539138	(0493 009 99D) (99D) Basket Strainer	\$173.39			
539140	(0493 010 99D) (99D) Basket Strainer	\$191.99			

Mfg. No.	(99C) Transparent Cylinder Only	(99D) Basket Strainer	(99L) Hinged Bolt for Cover with Pin, Nut and Washer	(99M) Cork Gasket Kit: (1) Cover and (2) Cork Cylinder Gaskets	(99R) Rubber Gasket Kit: (1) Cover and (2) Rubber Cylinder Gaskets
(0493 004 PLB)	539025 (0493 004 99C)	539087 (0493 004 99D)	539377 (0493 DP5 99L)	539291 (0493 DP5 99M)	539295 (0493 DP5 99R)
(0493 005 PLB)	539037 (0493 005 99C)	539095 (0493 005 99D)	539377 (0493 DP5 99L)	539291 (0493 DP5 99M)	539295 (0493 DP5 99R)
(0493 006 PLB)	539049 (0493 006 99C)	539102 (0493 006 99D)	539378 (0493 DP7 99L)	539316 (0493 DP7 99M)	539300 (0493 DP7 99R)
(0493 007 PLB)	539051 (0493 007 99C)	539114 (0493 007 99D)	539378 (0493 DP7 99L)	539316 (0493 DP7 99M)	539300 (0493 DP7 99R)
(0493 008 PLB)	539063 (0493 008 99C)	539126 (0493 008 99D)	539379 (0493 DP9 99L)	539328 (0493 DP9 99M)	539330 (0493 DP9 99R)
(0493 009 PLB)	539075 (0493 010 99C)	539138 (0493 009 99D)	539379 (0493 DP9 99L)	539328 (0493 DP9 99M)	539330 (0493 DP9 99R)
(0493 010 PLB)	539075 (0493 010 99C)	539140 (0493 010 99D)	539379 (0493 DP9 99L)	539328 (0493 DP9 99M)	539330 (0493 DP9 99R)

- Electronics
- Trolling Motors
- Instruments
- Electrical
- Lighting
- Anchor & Dock
- Safety
- Steering, Controls
- Pumps
- Fuel System
- Seating & Pedestals
- Trailering
- Tops & Covers
- Perform.
- Propellers
- Engine & Care
- Cleaning & Care
- Paint & Paint Acc.
- Fun & Flotation
- Topside Acc.
- Cockpit & Deck
- Hardware, Fasteners
- Camouflage
- Misc.
- Comm.

Perko Fig. 500 Heavy Duty Intake Water Strainer



- Cast bronze with stainless steel basket and clear polycarbonate cylinder.
- For applications requiring higher capacity.
- Designed for easy installation and cleaning.
- Mounting lugs cast into both sides to assure universal mounting.
- Four outside tie rods.
- Stainless steel strainer basket minimizes electrolysis.
- .079" screen hole diameter provides 47% open area.
- Hinged lugs on cover permit easy removal and cleaning of the strainer basket.
- A drain plug in the bottom casting is provided for easily removing sediment and draining for winterizing.
- Tested and accepted for labeling and UL listed.

Electronics

Trolling Motors

Instruments

Electrical

Order No.	Mfg. No.	Pipe Size	Height	Width	Cylinder Dimensions	List Price
539506	(0500 011 PLB)	3"	18-1/2"	9"	8" x 14"	\$1,376.99 E0-4723010

SPARE PARTS

Order No.	Mfg. No. / Description	List Price
539518	(0500 011 99C) Transparent Cylinder	\$413.49 G0-4077200
539520	(0500 011 99D) Basket Strainer	\$407.39 G0-5927200
539544	(0500 DP9 99L) Hinged Bolt for Cover with Pin, Nut and Washer	\$60.09 G0-6204000
539532	(0500 DP9 99M) Cork Gasket Kit: (1) Cover Gasket & (2) Cork Cylinder Gaskets	\$62.99 G0-0224000
539535	(0500 DP9 99R) Rubber Gasket Kit: (1) Cover Gasket & (2) Rubber Cyl. Gaskets	\$62.99 G0-0224000

Lighting

Anchor & Dock

Safety

Steering, Controls

Perko Fig. 693 Heavy Duty Intake Water Strainer for 4" Pipe



Pumps

Fuel System

Seating & Pedestals

Trailer

Tops & Covers

Perform.

Propellers

Engine & Care

Cleaning & Care

Paint & Paint Acc.

Fun & Flotation

Topside Acc.

Cockpit & Deck

Hardware, Fasteners

Misc.

Comm.



Easy Open Top, Simply Loosen 4 Captive Nuts



Twist and Lift

- Cast bronze cap with handle with stainless steel basket and clear polycarbonate cylinder..
- Designed for easy installation and cleaning.
- Aircraft style mounting nuts hold fast without lock washers. They are held captive by the body and can't be dropped or lost. Once the mounting nuts are loosened, a convenient handle on the top cover allows it to be easily rotated and removed providing quick access to the strainer basket.
- Four 316 stainless steel tie rods and strainer basket minimize electrolysis.
- The diameter of the screen holes is 0.079" providing 47% open area.
- A drain plug in the bottom casting is provided for easily removing sediment and draining for winterizing.
- A transparent cylinder provides a visual check for debris.

Order No.	Mfg. No.	Pipe Size	Height	Width	Cylinder Dimensions	List Price
539556	(0693 012 PLB)	4"	17-1/2"	16-1/2"	12" x 8-3/4"	\$5,550.99 E0-4236140

SPECIAL HANDLING MAY APPLY





Groco ARG Series Raw Water Strainers

GROCO.

REPLACEMENT PARTS

Order No.	Mfg. No. / Description	List Price	
373201	(BP-01) Filter Basket - Polyethylene	\$39.39	GO-9362000
373213	(BP-02) Filter Basket - Polyethylene	\$41.29	GO-6672000
373225	(BP-03) Filter Basket - Polyethylene	\$47.79	GO-2023000
373237	(BP-05) Filter Basket - Polyethylene	\$55.29	GO-4073000
373249	(BP-6) Filter Basket - Polyethylene	\$54.39	GO-4463000
373251	(BP-8) Filter Basket - Polyethylene	\$65.59	GO-5934000
373263	(BP-11) Filter Basket - Polyethylene	\$62.79	GO-7024000
373265	(BP-15) Filter Basket - Polyethylene	\$62.79	GO-7024000
373085	(ARG-1) Service Kit	\$16.89	GO-2311000
373097	(ARG-2) Service Kit	\$19.19	GO-6821000
373100	(ARG-3) Service Kit	\$21.39	GO-3341000
373275	(ARG-0503) Sight Glass	\$50.59	GO-0933000
373287	(ARG-0753) Sight Glass	\$55.29	GO-4073000
373299	(ARG-1003) Sight Glass	\$67.49	GO-2254000
373302	(ARG-1253) Sight Glass	\$78.79	GO-9725000
373298	(ARG-1503) Sight Glass	\$105.89	GO-5907000
373304	(ARG-2003) Sight Glass	\$121.79	GO-0618000
373314	(ARG-2503) Sight Glass	\$140.59	GO-0249000
373326	(ARG-3003) Sight Glass	\$161.19	GO-0080100
373655	(ARG-0756) Drain Plug without O-ring	\$4.69	GO-4130000
373645	(ARG-0506) Drain Plug (prior 08/01/01) w/o O-ring	\$10.39	GO-6960000
373579	(ARG-501-PC) Cap - Plastic	\$19.69	GO-9131000
373582	(ARG-1001-PC) Cap - Plastic	\$27.19	GO-2281000
373592	(ARG-1501-PC) Cap - Plastic	\$34.69	GO-4232000
373532	(ARG-0501-C) Cap - Bronze	\$60.99	GO-6804000
373556	(ARG-1501-C) Cap - Bronze	\$151.79	GO-0710100
373719	(ARG-0505) Bracket, Upper	\$7.49	GO-2050000
372728	(ARG-1005) Bracket, Upper	\$19.69	GO-9131000
373732	(ARG-0504) Bracket, Lower	\$8.49	GO-9650000
373744	(ARG-1004) Bracket, Lower	\$23.49	GO-4751000
373758	(ARG-0502) Strap	\$5.69	GO-1830000
373821	(2-135) O-ring - Cap	\$0.99	GO-6600000
373835	(2-229) O-ring - Cap	\$1.89	GO-7210000
373845	(2-234) O-ring - Cap	\$1.89	GO-7210000
373871	(2-228) O-ring - Basket	\$0.99	GO-6600000
373883	(2-232) O-ring - Basket	\$1.89	GO-7210000
373895	(2-238) O-ring - Basket	\$1.89	GO-7210000
373936	(2-153) O-ring - Sight Glass	\$1.89	GO-7210000
373948	(2-157) O-ring - Sight Glass	\$1.89	GO-7210000
373958	(2-256) O-ring - Sight Glass	\$2.89	GO-4910000
373112	(2-238) Filter Basket - #304 SS	\$41.29	GO-6672000
373124	(BS-02) Filter Basket - #304 SS	\$43.19	GO-4982000
373136	(BS-03) Filter Basket - #304 SS	\$41.79	GO-0082000
373137	(BS-04) Filter Basket - #304 SS	\$44.99	GO-4103000
373148	(BS-05) Filter Basket - #304 SS	\$46.89	GO-2413000
373150	(BS-06) Filter Basket - #304 SS	\$53.49	GO-4853000
373162	(BS-08) Filter Basket - #304 SS	\$57.19	GO-2383000
373174	(BS-11) Filter Basket - #304 SS	\$59.09	GO-9593000
373186	(BS-15) Filter Basket - #304 SS	\$63.79	GO-4724000

- Mounting system allows removal without tools.
- Bonding connection both sides.
- O-ring seal all joining surfaces.
- Filter basket options: #304 SS (Standard), Monel and Non-Metallic.
- One-piece molded sight glass eliminates tie rods and gaskets.
- Improved drain plug.
- Non-metallic cap magnifies internal viewing.
- Improved basket design.
- C84400 bronze head casting.
- UL Listed 255-D.



Order No.	Mfg. No.	Pipe	Cylinder Diameter	Cylinder Height	List Price	
373009	(ARG-0500-S)	1/2"	5.5"	6.4"	\$191.19	GO-0182100
373011	(ARG-0750-S)	3/4"	4.5"	8.4"	\$180.99	GO-6212100
373023	(ARG-1000-S)	1"	6.8"	9.0"	\$257.59	GO-9527100
373035	(ARG-1250-S)	1-1/4"	5.8"	10.6"	\$276.69	GO-8358100
373037	(ARG-1500-S)	1-1/2"	8.3"	11.4"	\$412.39	GO-0367200
373039	(ARG-2000-S)	2"	7.3"	14"	\$431.49	GO-0198200
373041	(ARG-2500-S)	2-1/2"	8.3"	17"	\$512.39	GO-0334300
373059	(ARG-3015-S)	3"	7.3"	13.3"	\$567.79	GO-2408300
373043	(ARG-3000-S)	3"	7.3"	19.8"	\$559.39	GO-9747300

DIAGRAM FOR REPLACEMENT PARTS

* Stock Items.

- | Item No. | Name |
|----------|----------------|
| (1) | Head Casting |
| (2)* | Sight Glass |
| (3)* | Drain Plug |
| (4)* | Cap |
| (5) | Washer |
| (6) | Washer |
| (7) | Hex Bolt |
| (8) | Hex Bolt |
| (9)* | Bracket, Upper |
| (10)* | Bracket, Lower |
| (11)* | Strap |
| (12)* | O-ring |
| (13) | O-ring |
| (14)* | O-ring |
| (15)* | O-ring |
| (16)* | Basket |

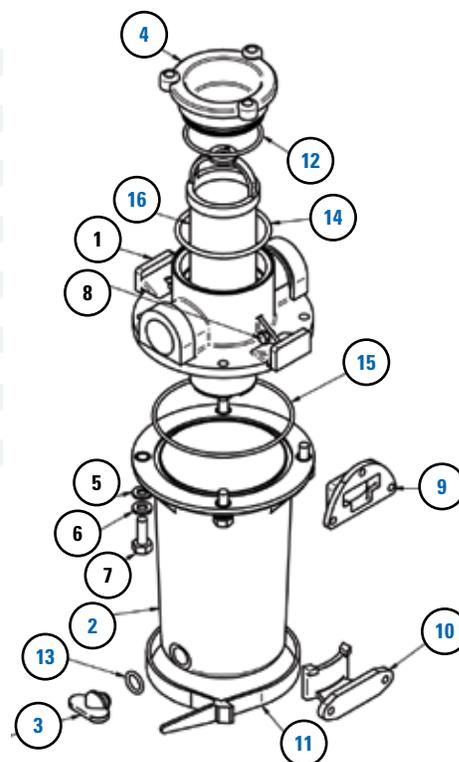

Mfg. No.	(2) Sight Glass	(3) Drain Plug	(3) Drain Plug Prior 08/01/01	(4) Cap - Plastic	(4) Cap - Bronze	(9) Bracket, Upper	(10) Bracket, Lower	(11) Strap	(12) O-ring Cap	(14) O-ring Basket	(15) O-ring Sight Glass	(16) Filter Baskets, #304 SS	(16) Filter Baskets, Polyethylene	Service Kit
(ARG-0500-S)	373275	373655	373645	373579	373532	373719	373732	373758	373821	373871	373936	373112	373201	373085
(ARG-0750-S)	373287	373655	373645	373579	373532	373719	373732	373758	373821	373871	373936	373124	373213	373085
(ARG-1000-S)	373299	373655	373645	373582	N/A	372728	373744	373758	373835	373883	373948	373136	373225	373097
(ARG-1250-S)	373302	373655	373645	373582	N/A	372728	373744	373758	373835	373883	373948	373148	373237	373097
(ARG-1500-S)	373298	373655	373645	373592	373556	N/A	N/A	N/A	373845	373895	373958	373150	373249	373100
(ARG-2000-S)	373304	373655	373645	373592	373556	N/A	N/A	N/A	373845	373895	373958	373162	373251	373100
(ARG-2500-S)	373314	373655	373645	373592	373556	N/A	N/A	N/A	373845	373895	373958	373174	373263	373100
(ARG-3015-S)	373298	373655	373645	373592	373556	N/A	N/A	N/A	373845	373895	373958	(BS-12)	(BP-12)	373100
(ARG-3000-S)	373326	373655	373645	373592	373556	N/A	N/A	N/A	373845	373895	373958	373186	373265	373100



Groco SA Series Raw Water Strainers



- For installation on the suction side of engines and pumps.
- The ideal filtration solution for cooling water intakes for any marine engine, ac unit or genset.
- The design makes them long lasting and easy to service while the variety of sizes means there is a fit for every application.
- In production for more than 50 years.
- Standard with #304 stainless steel filter basket. (Monel is optional).
- Monel inside tie rod and #316 stainless steel outer tie rods.
- Easy service with spin-off-wing nut.
- Crystal clear cast acrylic cylinder.
- Fine mesh filter baskets are also available.
- C84400 bronze construction.



- Electronics
- Trolling Motors
- Instruments
- Electrical
- Lighting
- Anchor & Dock

Order No.	Mfg. No.	Pipe	Cylinder Diameter	Cylinder Height	List Price
373364	(SA-1000-S)	1"	5.5"	10.5"	\$509.69
373388	(SA-1500-S)	1-1/2"	6.8"	13.8"	\$721.19
373390	(SA-2000-S)	2"	6.8"	16.5"	\$937.79
373403	(SA-2500-S)	2-1/2"	7.8"	18.8"	\$1,045.69
373415	(SA-3000-S)	3"	7.8"	21.5"	\$1,251.69

REPLACEMENT PARTS

Order No.	Mfg. No. / Description	List Price
373718	(SVS-5) Wingnut	\$17.89
373720	(S-75) Wingnut	\$26.29
373734	(500-K) Wingnut Washer	\$0.99
373746	(504-F) Wingnut Washer	\$0.99
373201	(BP-01) Filter Basket - Polyethylene	\$39.39
373213	(BP-02) Filter Basket - Polyethylene	\$41.29
373237	(BP-05) Filter Basket - Polyethylene	\$55.29
373249	(BP-6) Filter Basket - Polyethylene	\$54.39
373251	(BP-8) Filter Basket - Polyethylene	\$65.59
373263	(BP-11) Filter Basket - Polyethylene	\$62.79
373112	(2-238) Filter Basket - #304 SS	\$41.29
373124	(BS-02) Filter Basket - #304 SS	\$43.19
373137	(BS-04) Filter Basket - #304 SS	\$44.99
373148	(BS-05) Filter Basket - #304 SS	\$46.89
373150	(BS-06) Filter Basket - #304 SS	\$53.49
373162	(BS-08) Filter Basket - #304 SS	\$57.19
373174	(BS-11) Filter Basket - #304 SS	\$59.09
373198	(BS-19) Filter Basket - #304 SS	\$62.79
373605	(S-77) Sight Glass, Clear	\$131.19
373631	(S-88-A) Sight Glass, Clear	\$237.99
373578	(S-87-A) Tie Rod, Outside	\$7.49
373681	(#09R SET) Gasket	\$13.19
373693	(#08R SET) Gasket	\$14.09
373706	(#10R SET) Gasket	\$14.09
373441	(SA-1) Service Kit	\$30.39
373453	(SA-2) Service Kit	\$32.69
373465	(SA-3) Service Kit	\$32.69

DIAGRAM FOR REPLACEMENT PARTS

* Stock Items.

Item No.	Name
(1)*	Wingnut
(2)*	Washer
(3)	Cover
(4)	Gasket
(5)*	Basket
(6)	Head Casting
(7)*	Sight Glass
(8)	Tie Rod, Center
(9)*	Tie Rod, Outside
(10)*	Gasket
(11)	End Cap
(12)	Drain Plug
(13)	Hex Nut
(14)	Washer

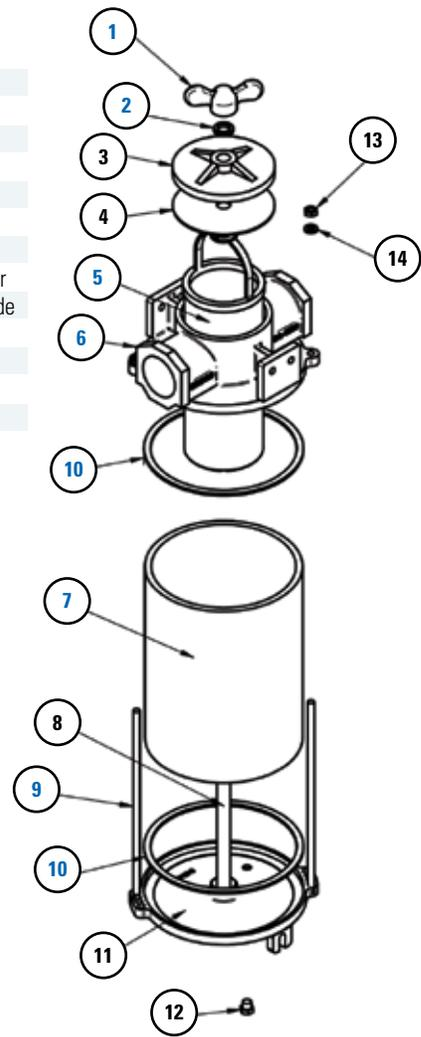

Mfg. No.	(1) Wingnut	(2) Wingnut Washer	(5) Filter Baskets, #304 SS	(5) Filter Baskets, Polyethylene	(7) Sight Glass, Clear	(9) Tie Rod, Outside	(10) Gasket	(11) End Cap	Service Kit
(SA-500-S)	373718	373734	373112	373201	(S-70)	(S-66)	373681	(S-63-A)	373441
(SA-750-S)	373718	373734	373124	373213	(S-70-A)	(S-73-X)	373681	(S-63-A)	373441
(SA-1000-S)	373720	373734	373137	(BP-4)	373605	(S-73-X)	373693	(S-73-A)	373453
(SA-1250-S)	373720	373734	373148	373237	(S-77-A)	(S-73-B)	373693	(S-73-A)	373453
(SA-1500-S)	373720	373746	373150	373249	(S-88)	(S-73-B)	373706	(S-82-A)	373465
(SA-2000-S)	373720	373746	373162	373251	373631	373578	373706	(S-82-A)	373465
(SA-2500-S)	373720	373746	373174	373263	373643	(S-87-B)	373706	(S-82-A)	373465
(SA-3000-S)	373720	373746	373198	(BP-19)	(S-88-C)	(S-87-C)	373706	(S-82-A)	373465

Groco SD Series High Flow Raw Water Strainers

GROCO.



- For installation on the suction side of engines and pumps.
- The ideal filtration solution for heavy duty cooling water intakes for marine engine, ac unit or genset.
- Greater filtering capacity than Groco ARG or SA model strainers.
- Improved cylindrical filter basket.
- Improved design secures filter basket under all flow conditions.
- O-rings seal all mating surfaces.
- Monel inside tie rod.
- Crystal Clear cast acrylic sight glass.
- Easy service is provided by the spin-off wing nut.
- C84400 bronze construction.
- UL Listed 255D.

Order No.	Mfg. No.	Pipe	Cylinder Diameter	Cylinder Height	List Price	
373908	(SD-2000-S)	2"	8.9"	14.5"	\$1,307.29	F0-0151900
373910	(SD-2500-S)	2-1/2"	8.9"	20.4"	\$1,478.79	F0-5153010
373922	(SD-3000-S)	3"	8.9"	22.4"	\$1,457.99	E0-9439010

REPLACEMENT PARTS

Order No.	Mfg. No. / Description	List Price	
373960	(SSD-17) Filter Basket - #304 SS for 373908	\$229.69	F0-8706100
373972	(SSD-17-A) Filter Basket - #304 SS for 373910	\$235.79	F0-5056100
373984	(SSD-17-B) Filter Basket - #304 SS for 373922	\$237.49	F0-4266100
374075	(S-85) Wingnut for All Models	\$46.69	H0-1082000
374087	(SD-14) Cap for All Models	\$213.99	F0-9794100
373946	(SD) Service Kit for All Models	\$44.19	F0-3903000

Groco SE Series - Large Engine Strainer

GROCO.



- Crystal clear cast acrylic sight glass.
- Cap and basket have replaceable zinc anode protection.
- Low restriction for maximum cooling water flow.
- No inside tie rods.
- Cover unscrews for easy filter basket cleaning.
- O-rings seal all mating surfaces.
- Improved cylindrical filter basket.
- Stainless steel filter basket.
- Bronze construction.
- Cylinder diameter 13". Cylinder height 18.4".

Order No.	Mfg. No. / Description	List Price	
373934	(SE-4000) 4" NPT	\$5,688.89	F0-2228930

ACCESSORIES

Order No.	Mfg. No. / Description	List Price	
373950	(SE) Repair Kit	\$52.49	H0-9413000
373959	(SE-4003-1) Monel Basket	\$722.79	F0-5950500
S/O	(SE-4001-A) Cap	Price On Request	

Groco BVS Series Valve/Strainer Combo

GROCO.



- Square hole in handle accepts standard ratchet.
- 1-1/4" sizes and larger include one grease zerk fitting for lubrication (use only with the valve in the open position) and one drain plug. The zerk can also be used for draining.
- Space saving design with strainer and integral seacock.
- Just one component to install and just one bilge location to access for winterization and maintenance.
- No inside tie rods.
- Strainer has screw on/off cap.
- Full flow ball valve with stainless steel ball and stem.
- C84400 bronze construction.
- #304 stainless steel filter basket.

Order No.	Mfg. No.	Thread Bottom NPS	Thread Top NPT	Overall Diameter	Flange	List Price	
373756	(BVS-0750)	3/4"	3/4"	10.75"	3.05"	\$675.79	G0-8725400
373764	(BVS-1000)	1"	1"	11.25"	4.13"	\$871.29	G0-6738500
373770	(BVS-1250)	1-1/4"	1-1/4"	14.88"	4.13"	\$1,049.29	G0-2030700
373782	(BVS-1500)	1-1/2"	1-1/2"	15"	5.25"	\$1,338.59	G0-6869800

REPLACEMENT PARTS

Order No.	Mfg. No. / Description	List Price	
373869	(SSS-1004) Filter Basket - #304 SS for 373764	\$65.59	G0-5934000
373875	(SSS-1254) Filter Basket - #304 SS for 373770	\$69.39	G0-9464000
373886	(SSS-1504) Filter Basket - #304 SS for 373782	\$85.29	G0-4175000
373807	(BVS-1) Service Kit for 373756	\$25.29	G0-4961000
373819	(BVS-2) Service Kit for 373764 and 373770	\$26.29	G0-1671000

Groco Spanner Wrench

GROCO.



- Cast bronze with stainless steel pins to fit 1/4" and 5/16" holes.
- Opens to service deck plates or strainer caps with key holes up to 7" apart.
- Hangs conveniently near the strainer(s) location.
- C83600 bronze.
- NOTE: Do not use SW-2531 to tighten non-metallic caps.

Order No.	Mfg. No. / Description	List Price	
377000	(SW-2531)	\$30.09	G0-6102000



SPECIAL HANDLING MAY APPLY



- Electronics
- Trolling Motors
- Instruments
- Electrical
- Lighting
- Anchor & Dock
- Safety
- Steering, Controls
- Pumps
- Fuel System
- Seating & Pedestals
- Trailer
- Tops & Covers
- Perform.
- Propellers
- Engine & Care
- Cleaning & Care
- Paint & Paint Acc.
- Fun & Flotation
- Topside Acc.
- Cockpit & Deck
- Hardware, Fasteners
- Camouflage
- Misc.
- Comm.

Electronics

Trolling Motors

Instruments

Electrical

Lighting

Anchor & Dock

Safety

Steering, Controls

Pumps

Fuel System

Seating & Pedestals

Trailering

Tops & Covers

Perform.

Propellers

Engine & Care

Cleaning & Care

Paint & Paint Acc.

Fun & Flotation

Topside Acc.

Cockpit & Deck

Hardware, Fasteners

Misc.

Comm.

Marpac Hand Bilge Pump



- 24" hand bilge pump with 36" hose.
- Perfect for use on small boats, dinghies and lockers or any other place water collects.

Order No.	Description	List Price
7-57004	Hand Bilge Pump	\$25.59

Beckson Thirsty-Mate® High Capacity Hand Super Pump

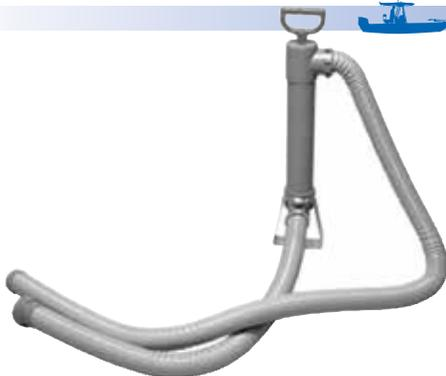

- All plastic - will not rust or corrode or mar your boat.
- High capacity pump.
- Self lubricating.
- Length 24".
- Diameter 3".
- Capacity 22 GPM.
- 3 strokes per gallon.
- Provided with 2" wire reinforced vinyl hose.
- Inlet hose: Length 4'. Outlet hose: Length 6'.

Order No.	Mfg. No. / Description	List Price
247533	(519-C)	\$360.59

Whale Gusher Urchin Manual Bilge Pump



- Manufactured by hand using high grade materials based on more than 60 years experience.
- Ease of operation molded grip handle.
- Easy maintenance easy remove clamp ring.
- Versatility of installation removable clamping ring for head rotation.
- Simple plumbing 25 mm (1") or 38 mm (1-1/2") smooth hose connection options.
- Proven design tough yet light weight polypropylene materials.
- Secure fit robust molded base.
- Compact design ideal for confined spaces.
- Reliable performance tricuspid outlet valve.

Order No.	Mfg. No. / Description	List Price
587517	(BP9005)	\$82.09

Beckson Thirsty-Mate® Hand Bilge Pumps

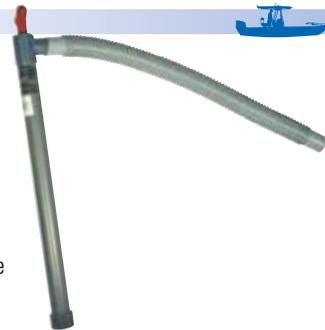

- All plastic - will not rust or corrode or mar your boat.
- It is self-priming and very easy to clean.
- Self lubricating.
- If your THIRSTY-MATE hand pump becomes clogged, simply remove the foot valve assembly and clean out the inside.
- Includes: Flexible hose.
- Manufactured in the USA.

Order No.	Mfg. No.	Length	Hose Length	Strokes Per Gallon	List Price
247456	(118PF)	18"	20"	10	\$39.09
247470	(124PF)	24"	24"	6	\$43.89
247482	(124PF6)	24"	72"	6	\$58.29
247494	(136PF)	36"	36"	4	\$53.99
247507	(136PF6)	36"	72"	4	\$64.99

Whale Gusher Titan Manual Bilge Pump



- High flow rate: 28 US gals (105 ltrs) per minute.
- Clamp ring easily removed for pump head rotation.
- Tough yet lightweight proven design.
- Quick maintenance - Clamp ring easily removed for pump head rotation.
- Typical uses: Bilge pump out, holding tank pump out, toilet flush.
- Ease of operation - Self priming and spring assisted outlet valve.
- Straight forward installation.

Order No.	Mfg. No. / Description	List Price
587510	(BP4410)	\$191.49

Rule Non-Automatic Bilge Pumps



- Compact, efficient, long-life motors.
- Ability to run dry for short periods.
- Easy-clean, snap-lock strainer bases.
- Stainless steel shafts.
- Completely submersible.
- Rust and corrosion protection.
- Higher flow - Optimized impeller to provide greater flow at the same amperage.
- Built-in thermal cut-off - Provides added protection for pump and vessel.
- Back flow prevention.
- Hidden air vents in the body.
- Threaded discharge.

DISCHARGE 3/4"

Order No.	Mfg. No.	Size	Volt	Dimensions	List Price	
582000	(24DA)	360 GPH	12	3-7/8" H x 2-7/8" W	\$25.39	GO-1071000
582026	(25DA)	500 GPH	12	3-7/8" H x 2-7/8" W	\$33.89	GO-1722000
582042	(20DA)	800 GPH	12	4-3/8" H x 2-7/8" W	\$52.79	GO-7353000
581864	(21R)	800 GPH	24	4-3/8" H x 2-7/8" W	\$59.99	GO-9104000

DISCHARGE 1-1/8"

Order No.	Mfg. No.	Size	Volt	Dimensions	List Price	
582064	(27DA)	1,100 GPH	12	4-3/8" H x 2-7/8" W	\$60.09	GO-6204000

Rule LoPro Series Bilge Pumps



- Only 2.4" tall - about half the height of a normal bilge pump.
- Fully rotating discharge body. The entire body swivels up to 180°, making for an easy plumbing installation.
- Threaded discharge nozzle. Multiple ports are available for this pump: 3/4" straight, 3/4" right angle, 1" and 1-1/8".
- New tricuspid check valves help prevent backflow.
- Dimensions: 2.4" H x 2.4" W.
- 12 volt.

AUTOMATIC BILGE PUMP. LENGTH 9"

- Features two automated modes. The first one engages the pump when the water level reaches 2" or 1.3" (user choice); and the second one checks for water by briefly turning on the pump every 2-1/2 minutes.

Order No.	Mfg. No. / Description	List Price	
582333	(LP900S) 900 GPH	\$80.69	GO-6045000

NON-AUTOMATIC BILGE PUMP. LENGTH 7.12"

- Uses a traditional float and/or panel switch for operation.

Order No.	Mfg. No. / Description	List Price	
582335	(LP900D) 900 GPH	\$64.19	GO-1034000

Rule Non-Automatic Bilge Pumps



- Compact, efficient long life motor.
- Ability to run dry for short periods.
- Easy clean, snap lock strainer bases.
- Stainless steel shafts.
- Completely submersible.
- Silent and vibrationless operation.
- Ignition protected.
- Rust and corrosion protection.
- Width 2-7/8", height 4".
- 12 volt.

Order No.	Mfg. No. / Description	List Price	
582040	(20F) 800 GPH Discharge 3/4"	\$53.49	GO-4853000
582052	(20A) 1,000 GPH Discharge 1-1/8"	\$54.99	GO-4863000

Rule Side Mount Brackets for Non-Automatic Bilge Pumps



- Permits small Rule bilge pumps to be side mounted to a vertical stringer, a bulkhead or a transom.
- Use this bracket when bottom mounting is inconvenient or impossible.
- Simply remove the strainer from the pump, put the bracket in place and reassemble.
- For use with Rule 360 - 1,100 GPH round bilge pumps.

Order No.	Mfg. No. / Description	List Price	
582886	(66)	\$7.29	GO-8840000
582888	(66A) For the Latest Bilge Pump Design	\$20.09	GO-6431000

Rule Non-Automatic Bilge Pumps



- Compact, efficient long life motor.
- Ability to run dry for short periods.
- Easy clean, snap lock strainer bases.
- Completely submersible.
- Silent and vibrationless operation.
- Ignition protected.
- Stainless steel shafts. Rust and corrosion protection.
- Discharge 1-1/8".
- Width 4-1/4", height 6".

Order No.	Mfg. No. / Description	List Price	
582456	(02) 1,500 GPH 12 volt	\$114.39	GO-4667000
582458	(03) 1,500 GPH 24 volt	\$140.79	GO-3349000
582494	(10) 2,000 GPH 12 volt	\$160.49	GO-3570100
582496	(10-6UL) 2,000 GPH 12 volt (UL Listed)	\$177.79	GO-2191100
582519	(12) 2,000 GPH 24 volt	\$177.79	GO-2191100
582521	(11) 2,000 GPH 32 volt	\$178.49	GO-9591100

GOLD-SERIES - 5 YEAR WARRANTY

- Easy clean triple stage snap lock strainer. Heavy 5/16" stainless steel shaft.

Order No.	Mfg. No. / Description	List Price	
582482	(09) 2,000 GPH 12 volt	\$188.89	GO-6562100

- Electronics
- Trolling Motors
- Instruments
- Electrical
- Lighting
- Anchor & Dock
- Safety
- Steering, Controls
- Pumps
- Fuel System
- Seating & Pedestals
- Trailering
- Tops & Covers
- Perform.
- Propellers
- Engine & Care
- Cleaning & Care
- Paint & Paint Acc.
- Fun & Flotation
- Topside Acc.
- Cockpit & Deck
- Hardware, Fasteners
- Camouflage
- Misc.
- Comm.

Rule Non-Automatic Bilge Pump



- Compact, efficient long life motor.
- Ability to run dry for short periods.
- Easy clean, snap lock strainer bases.
- Stainless steel shafts.
- Completely submersible.
- Silent and vibrationless operation.
- Ignition protected.
- Rust and corrosion protection.



3,700 GPH. DISCHARGE 1-1/2"

- Width 4-7/8", height 7-1/4".

Order No.	Mfg. No. / Description	List Price
582545	(14A) 3,700 GPH 12 volt	\$268.19 GO-9697100
582557	(16A) 3,700 GPH 24 volt	\$281.49 GO-0688100
582571	(15A) 3,700 GPH 32 volt	\$298.39 GO-2999100

4,000 GPH. DISCHARGE 2"

- Width 4-7/8", height 7-3/4".

Order No.	Mfg. No. / Description	List Price
582584	(56D) 4,000 GPH 12 volt	\$285.59 GO-5319100
582595	(56D-24) 4,000 GPH 24 volt	\$313.79 GO-4201200

Attwood Heavy Duty Bilge Pumps



- High efficiency permanent magnet motor utilizes composite brushes and lubricated bearings to ensure long life under the most aggressive load conditions.
- Rugged glass- and mineral-filled polymer components withstand hull pounding, harsh bilge environments and deteriorating effects of hose plasticizers..
- Advanced resin compositions incorporated in exterior to resist chemicals such as engine oil, aggressive detergents and hose plasticizers.
- Attwood's Heavy Duty bilge pump has unsurpassed durability and efficiency in a compact design to ensure electrical energy is converted to the pump rather than excess heat.
- Enhanced SS alloy motor shaft resists corrosion and reduces shaft seal degradation.
- Rotating outlet provides for improved hose installation.
- Locking tab and base swivel feature allow for 8 unique mounting positions.
- Dimensions: 5.97" H x 3.83" W.
- Hose size 1-1/8" ID.

Order No.	Mfg. No. / Description	List Price
236090	(4730-4) 1,700 GPH 12 volt	\$127.29 FO-0198000
236095	(4760-4) 2,000 GPH 12 volt	\$146.29 FO-0420100
236100	(4770-4) 2,000 GPH 24 volt	\$137.79 FO-5469000

Rule Adapters



- Designed to be used with Rule Pumps and thru-hulls.
- Heavy duty molded, non-corrosive, high impact plastic.

ADAPTER

- Adapts 1-1/2" outlet to 1-1/8" hose.

Order No.	Mfg. No. / Description	List Price
582839	(67)	\$9.49 GO-6360000

GARDEN HOSE ADAPTER

- Adapts 1-1/8" outlet to standard garden hose fitting.

Order No.	Mfg. No. / Description	List Price
582812	(68)	\$9.49 GO-6360000

DOUBLE-STEPPED STRAIGHT ADAPTER

- Double stepped straight adapter for adapting 1-1/8" outlet to 3/4" or 5/8" I.D. hose.

Order No.	Mfg. No. / Description	List Price
582824	(69)	\$6.79 GO-5540000

90° ELBOW ADAPTER

- 90° elbow adapters are designed for rigid pipe installations of Sump and Utility Pumps.
- Adapters snap onto discharge port without the need for a hose clamp.
- Adapts 1,800 GPH pump to 1" NPT.

Order No.	Mfg. No. / Description	List Price
582800	(57)	\$10.09 GO-6760000

Attwood Tsunami Series Cartridge Bilge Pumps



- Rugged, glass-filled and mineral-filled polymer body withstands hull pounding, bilge environments and deteriorating effects of plasticizers in hoses.
- Depress base tab to unlock filter from housing - ideal for maneuvering in tight spaces and for cleaning filter.
- Free-flowing water around motor housing keeps motor cooled and extends life.
- Double-filter base resists clogging
- 12 volt.

Order No.	Mfg. No. / Description	List Price
236059	(4606-7) T500 500 GPH Hose Size 3/4" ID	\$26.09 FO-6281000
236078	(4608-7) T800 800 GPH Hose Size 3/4" ID	\$39.49 FO-4672000
236112	(4612-7) T1200 1,200 GPH Hose Size 1-1/8" ID	\$51.69 FO-8163000

REPLACEMENT MOTOR CARTRIDGES

Order No.	Mfg. No. / Description	List Price
236060	(4620-6) For 236059 500 GPH	\$21.09 FO-6741000
236079	(4622-6) For 236078 800 GPH	\$31.29 FO-0912000
236081	(4624-6) For 236078 1,200 GPH	\$43.89 FO-2703000



Johnson Pump First Mate - Submersible Bilge Pump

- A low budget alternative designed for long life and high performance capacity.
- Bracket molded to pump.
- Diameter 4-1/2". Height 4".
- Connection 3/4".
- 12 volt.
- Made in the USA.

Order No.	Mfg. No. / Description	List Price
470514	(JP-21405) 400 GPH	\$29.89 G0-3002000

SPXFLOW
Johnson Pump



Johnson Pump Proline - Submersible Bilge Pumps

SPXFLOW
Johnson Pump



- Features an efficient, water-cooled motor with greater torque and less power consumption; a tough resin housing which resists shock, detergents, fuel and corrosives; a rugged impeller and a quick release bracket.
- Easy-to-install DuraPorts discharge ports including both a straight and a 90° externally threaded fitting.
- Connection 3/4".
- 12 volt.
- Made in the USA.

Order No.	Mfg. No. / Description	List Price
470524	(22502) 500 GPH	\$44.79 G0-1003000
470536	(22702) 750 GPH	\$46.69 G0-8213000

Johnson Pump Low Boy - Cartridge Submersible Bilge Pumps

SPXFLOW
Johnson Pump



- Low profile pump design for ease of mounting and removal in tight bilge areas.
- Perfect for vessels with bilge pumps mounted beneath inboard or I/O engines.
- **470688** has easy-to-install DuraPorts discharge ports including both a straight and a 90° externally threaded fitting.
- Use **471363** (36152) Electro-Magnetic Float Switch only.
- 12 volt.
- Made in the USA.

Order No.	Mfg. No. / Description	List Price
470688	(33703) 750 GPH Connection 3/4"	\$42.69 G0-0682000
470689	(33103) 1,250 GPH Connection 1-1/8"	\$53.39 G0-7753000

SPARE MOTOR CARTRIDGES

Order No.	Mfg. No. / Description	List Price
470738	(28572) For 470688 750 GPH	\$35.29 G0-4632000
470745	(JP-42522) For 470689 1,250 GPH	\$51.19 G0-0343000

Johnson Pump Cartridge Submersible Bilge Pumps

SPXFLOW
Johnson Pump



Spare Motor Cartridge

- Removable and upgradable motor cartridge bilge pump for easy maintenance and repair.
- **470687**, **470532** and **470548** has including both a straight and a 90° externally threaded fitting as well as a removable check valve included.
- 12 volt.
- Made in the USA.

Order No.	Mfg. No. / Description	List Price
470687	(32503) 500 GPH Connection 3/4"	\$28.79 G0-9291000
470532	(32703) 750 GPH Connection 3/4"	\$42.69 G0-0682000
470548	(32903) 1,000 GPH Connection 3/4"	\$45.89 G0-5703000
470232	(42123) 1,250 GPH Connection 1-1/8"	\$53.39 G0-7753000

SPARE MOTOR CARTRIDGES

Order No.	Mfg. No. / Description	List Price
470740	(28552) For 470687 500 GPH	\$25.59 G0-5171000
470738	(28572) For 470532 750 GPH	\$35.29 G0-4632000
470726	(28512) For 470548 1,000 GPH	\$44.79 G0-1003000
470745	(JP-42522) For 470232 1,250 GPH	\$51.19 G0-0343000

Johnson Pump Heavy Duty Submersible Bilge Pumps

SPXFLOW
Johnson Pump



- Wetted parts are made of high impact, non-corrosive thermoplastic; the shaft of stainless steel.
- A liquid-cooled, 12-pole, double ball-bearings equipped motor.
- Removable check valve included.
- Fully submersible.
- This pump can click into Rule base.
- Made in the USA.

CONNECTION: 1-1/8" AND 1-1/4"

Order No.	Mfg. No. / Description	List Price
470447	(16004-00) 1,600 GPH 12 volt	\$102.39 G0-0686000
470461	(22004) 2,200 GPH 12 volt	\$138.59 G0-6829000
470450	(22084) 2,200 GPH 24 volt	\$142.89 G0-4759000

CONNECTION: 1-1/2" AND 2"

Order No.	Mfg. No. / Description	List Price
470497	(40004) 4,000 GPH 12 volt	\$234.59 G0-8175100
470499	(40084) 4,000 GPH 24 volt	\$238.89 G0-6006100

Boater Sports Non-Automatic Submersible Bilge Pumps



- Submersible.
- Ignition protected.
- Tinned wire.
- Salt or fresh water.
- Stainless steel hardware included.
- Easy removal for cleaning.
- Bilge pumps have universal mounting base allowing pumps to snap into competitors bases without modification to mounting holes or position.
- Meets USCG requirements.
- 12 volt.

Order No.	Mfg. No. / Description	Discharge	List Price	Part No.
1-57412	(57412) 600 GPH	Discharge 3/4"	\$28.49	H0-9071000
1-57420	(57420) 800 GPH	Discharge 3/4"	\$31.09	H0-5681000
1-57426	(57426) 1,100 GPH	Discharge 1-1/8"	\$28.79	H0-7271000

Boater Sports High Output Submersible Bilge Pumps



- Submersible.
- Compact and efficiency long life motor.
- High pumping capacity.
- Ignition protected.
- Tinned wire.
- Turbo designed impeller.
- Quiet operation.
- Easy clean snap-lock strainer.
- Includes stainless steel mounting hardware.
- Discharge 1-1/8".
- 12 volt.

Order No.	Mfg. No. / Description	List Price	Part No.
1-57430	(57430) 1,500 GPH	\$91.29	H0-7745000
1-57435	(57435) 2,000 GPH	\$102.99	H0-9716000

Shurflo Replacement Cartridge for Piranha™ Bilge Pump



- Tough nylon impeller.
- Heavy duty motor.
- Ignition protected.
- Tinned 6' wire assembly.
- Replacement cartridge for Piranha Bilge Pump - 380 GPH.

Order No.	Mfg. No. / Description	List Price	Part No.
353115	(94-005-00)	\$30.89	G0-0702000

Boater Sports Cartridge Submersible Bilge Pump



1-57433



- Submersible.
- High impact, fully sealed construction.
- Quick and easy installation.
- Dual mount design.
- Cartridge design means simplified maintenance and unmatched safety when out on the water.
- Cartridge easily exchanges in case of pump failure.
- Discharge 3/4".
- 12 volt.

Order No.	Mfg. No. / Description	List Price	Part No.
1-57446	(57446) 800 GPH	\$26.39	H0-3851000
1-57433	(57433) Replacement Cartridge	\$26.59	H0-5951000

Marpac Cartridge Submersible Bilge Pump



- Easy installation.
- Extended life water cooled motor.
- Thermoplastic housing resists heat and stress.
- High grade 316 stainless steel shaft.
- Lightweight glass resin composite impeller resists breakage.
- Straight and omni-directional 90° hose barbs and backflow check valve included.
- Heavy duty 16 gauge corrosion resistant tinned wire.
- Quick change motor cartridge replacement (Order No. 7-2218).
- Easy to clean.
- Discharge 3/4".
- Meets and exceeds ABYC, U.S. Coast Guard, NMMA and IMCI (ISO 8849) specifications.
- 12 volt.

Order No.	Description	List Price	Part No.
7-0442	750 GPH	\$36.29	G0-1342000
7-2218	Replacement Motor Cartridge	\$33.79	G0-4622000

- Electronics
- Trolling Motors
- Instruments
- Electrical
- Lighting
- Anchor & Dock
- Safety
- Steering, Controls
- Pumps
- Fuel System
- Seating & Pedestals
- Trailering
- Tops & Covers
- Perform.
- Propellers
- Engine & Care
- Cleaning & Care
- Paint & Paint Acc.
- Fun & Flotation
- Topside Acc.
- Cockpit & Deck
- Hardware, Fasteners
- Camouflage
- Misc.
- Comm.

Rule Automatic Submersible Bilge Pumps



- Least amount of water in the bilge.
- No float switch needed.
- Checks for water every 2-1/2 minutes.
- Completely submersible.
- Ignition protected.
- High efficiency, low amp motor.
- No burn-out when run dry.
- Stainless steel shaft.
- Includes back flow preventor.
- 12 volt.

DISCHARGE 3/4"

Order No.	Mfg. No. / Description	List Price
582305	(25SA) 500 GPH 4.2" H x 2.9" W	\$93.89 G0-1926000
582310	(20SA) 800 GPH 4.2" H x 2.9" W	\$133.09 H0-5897000

DISCHARGE 1-1/8"

Order No.	Mfg. No. / Description	List Price
582329	(27SA) 1,100 GPH 4.7" H x 2.9" W	\$142.59 G0-4559000

DISCHARGE 1-1/8" 3 WIRE VERSION.

- 3 wire version allows manual override or indicator light capability.

Order No.	Mfg. No. / Description	List Price
582216	(51S) 1,500 GPH 7.75" H x 4.75" W	\$225.09 G0-1805100
582222	(53S) 2,000 GPH 7.75" H x 4.75" W	\$307.29 G0-8850200

Rule-Mate® Fully Automated Bilge Pumps



- All-in-one pump and switch - No float switch required.
- Featuring state of the art water sensing technology.
- Pump turns on when water level rises and shuts off when water is removed.
- Will not pump oil - straight motor oil that enters the bilge will not turn the pump on.
- Snap-off strainer for easy cleaning. Anti-fouling impeller.
- Discharge 1-1/8".

INCLUDES 1" AND 1-1/8" SCREW-ON HOSE BARB PORTS

- 1" NPT discharge PLUS included 1" and 1-1/8" screw-on hose barb ports.

Order No.	Mfg. No. / Description	List Price
582379	(RM1500A) 1,500 GPH 12 volt	\$242.49 G0-7426100
582381	(RM2000A) 2,000 GPH 12 volt	\$312.29 G0-3290200
582393	(RM2000A-24) 2,000 GPH 24 volt	\$340.89 G0-0482200

Rule-Mate® Level Sensing Bilge Pumps



- Our NEW RuleMate series bilge pumps provide ultimate pumping performance, which helps keep your bilge clear of nuisance water, building on the original Rule design.
- Rigorous engineering and testing helped generate the new series of RuleMate bilge pumps. Our pumps are tested to the highest standard, achieving rated performance at 12 volt, resulting in higher flow with better efficiency for the toughest applications.
- The RuleMate automatic bilge pump turns on automatically when water rises and switches off again when it's gone. Our pumps incorporate a market leading backup feature to tell you if something in the bilge has fouled or is blocking the pump giving peace of mind to the user.
- All new RuleMate series pumps now come with check valves to minimize unwanted water in the bilge, anti-airlock vents to help maximize performance and a thermal cut out feature for added security.
- Automatic level sensing with back up feature.
- Submersible and Ignition Protected.
- High efficiency, low amp motor.
- Stainless steel shaft.
- Includes backflow preventer.
- 12 volt.

Order No.	Mfg. No. / Description	List Price
582349	(RM500B) 500 GPH Discharge 3/4"	\$76.69 G0-8315000
582361	(RM800B) 800 GPH Discharge 3/4"	\$105.39 G0-1607000
582371	(RM1100B) 1,100 GPH Discharge 1-1/8"	\$135.09 G0-1509000

Rule Automatic Submersible Utility Pumps - 110 Volt



- Designed to remove water from basements, garages, stairwells, utility rooms, backyards, sumps, pools, pool covers, boats and other utility applications.
- Computerized automation eliminates need for float switches.
- Automatically checks for water every few minutes.
- Turns on when only 1" of water is detected.
- Never runs dry.
- Automatic shut off if impeller becomes jammed.
- Double insulated pump motor is permanently lubricated.
- Heavy duty thermoplastic housing.
- Totally submersible in fresh or salt water.
- Snap-off strainer for easy cleaning.
- Includes: Garden hose adapter and 90° elbow adapter for 1" NPT pipe.
- Discharge 1-1/8".
- 1,800 GPH.
- 110V AC.
- UL Listed.

Order No.	Mfg. No. / Description	List Price
582575	(A53S) Includes 8' Cord	\$245.89 G0-5746100
582580	(A53S-24) Includes 24' Cord	\$263.59 G0-1667100

- Electronics
- Trolling Motors
- Instruments
- Electrical
- Lighting
- Anchor & Dock
- Safety
- Steering, Controls
- Pumps
- Fuel System
- Seating & Pedestals
- Trailer
- Tops & Covers
- Perform.
- Propellers
- Engine & Care
- Cleaning & Care
- Paint & Paint Acc.
- Fun & Flotation
- Topside Acc.
- Cockpit & Deck
- Hardware, Fasteners
- Camouflage
- Misc.
- Comm.

Boater Sports Automatic Submersible Bilge Pump



- Submersible.
- Ignition protected.
- Tinned wire.
- Salt or fresh water.
- Stainless steel hardware included.
- Easy removal for cleaning.
- Meets USCG requirements.
- Discharge 3/4".
- 12 volt.

Order No.	Mfg. No. / Description	List Price
1-57422	(57422) 800 GPH	\$50.09 HO-5003000

Johnson Pump Heavy Duty Automatic Submersible Bilge Pumps



- Fully submersible.
- Wetted parts are made of high impact, non-corrosive thermoplastic; the shaft of stainless steel.
- A liquid-cooled, 12-pole, double ball-bearings equipped motor.
- Removable check valve included.
- Made in the USA.

INCLUDES: ELECTRO-MAGNETIC FLOAT SWITCH

Order No.	Mfg. No. / Description	List Price
470146	(01604-00) 1,600 GPH 12 volt	\$147.19 GO-2689000
470154	(02204-00) 2,200 GPH 12 volt	\$183.39 GO-7822100

INCLUDES: ULTIMA SWITCH

Order No.	Mfg. No. / Description	List Price
470240	(01674-001) 1,600 GPH 12 volt	\$153.59 GO-1920100
470242	(02274-001) 2,200 GPH 12 volt	\$189.79 GO-6172100

Johnson Ultima Bilge - Automatic Submersible Bilge Pumps



Johnson Pump Automatic Submersible Bilge Pumps



Spare Motor Cartridge

- Removable cartridge.
- Easy to clean.
- Non-clogging pump.
- Salt water tough.
- Water cooled motor for long service intervals.
- 500 GPH, 750 GPH and 1,000 GPH pumps has easy-to-install DuraPorts discharge ports including both a straight and a 90° externally threaded fitting as well as a removable check valve included.
- 12 volt.
- Made in the USA.

INCLUDES: ELECTRO-MAGNETIC FLOAT SWITCH

Order No.	Mfg. No. / Description	Connection	List Price
470526	(05503-00) 500 GPH	Connection 3/4"	\$73.59 GO-1394000
470538	(05703-00) 750 GPH	Connection 3/4"	\$87.49 GO-2685000
470549	(05903-00) 1,000 GPH	Connection 1-1/8"	\$88.29 GO-5195000

INCLUDES: ULTIMA SWITCH

Order No.	Mfg. No. / Description	Connection	List Price
470528	(07503-00) 500 GPH	Connection 3/4"	\$79.99 GO-9535000
470529	(07703-00) 750 GPH	Connection 3/4"	\$93.89 GO-1926000
470530	(07903-00) 1,000 GPH	Connection 3/4"	\$97.09 GO-5056000
470531	(08203-00) 1,250 GPH	Connection 1-1/8"	\$104.49 GO-1007000

SPARE MOTOR CARTRIDGES

Order No.	Mfg. No. / Description	List Price
470740	(28552) For 500 GPH Pumps	\$25.59 GO-5171000
470738	(28572) For 750 GPH Pumps	\$35.29 GO-4632000
470726	(28512) For 1,000 GPH Pumps	\$44.79 GO-1003000
470745	(JP-42522) For 1,250 GPH Pumps	\$51.19 GO-0343000

- Sleek, reliable and compact unit with integrated switch ready to install and run for years.
- **470120**, **470122** and **470124** includes a straight and a 90° smooth elbow DuraPorts external fittings and a removable check valve.
- 12 volt.
- Made in the USA.

Order No.	Mfg. No. / Description	Connection	List Price
470120	(32-47258-003) 600 GPH	3/4"	\$66.19 GO-5344000
470122	(32-47259-003) 800 GPH	3/4"	\$89.59 GO-3006000
470124	(32-47260-003) 1,000 GPH	3/4"	\$95.99 GO-1346000
470126	(32-47261-002) 1,250 GPH	1-1/8" & 1-1/4"	\$113.09 GO-7757000

Marpac Premier Digitally Controlled Automatic Bilge Pumps



- Rugged ABS fuel resistant housing.
- Patented "Field Effect" sensing technology that uses micro electrical fields to turn the pump on/off when water is detected.
- Advanced digital design that is Mercury free with no float switch to be jammed on or off.
- Simple 3 wire design is easy to install and can be run in auto or manual override mode.
- **7-2206** and **7-2208** includes a straight and omni-directional 90° hose barbs, as well as a backflow check valve.
- Made in USA, this pump is NMMA, ABYC, USCG and CE Certified.
- Includes a 3 year warranty.

Order No.	Description	List Price
7-2206	600 GPH Discharge 3/4"	\$56.19 G0-5673000
7-2208	800 GPH Discharge 3/4"	\$81.99 G0-3945000
7-2212	1,250 GPH Discharge 1-1/8" and 1-1/4"	\$103.49 G0-4396000

Boater Sports Bilge Pump with Float Switch



- 600 GPH bilge pump packaged with **1-57438** (57438) float switch.
- Submersible.
- Ignition protected and meets USCG requirements.
- Discharge 3/4".

Order No.	Mfg. No. / Description	List Price
1-57418	(57418) 600 GPH	\$35.69 H0-1412000

Boater Sports Automatic Float Switch



- Activates pump automatically.
- Submersible.
- For use with all DC bilge pumps.
- Stainless steel hardware included.
- 12 volt.

Order No.	Mfg. No. / Description	List Price
1-57438	(57438)	\$10.29 H0-7160000

Attwood Sahara Series Automatic Bilge Pumps



- Includes pump, wire, seals, strainer and mercury-free switch.
- Permanent magnet motor lubricated bearings for longer life.
- 316 stainless steel motor shaft for saltwater corrosion resistance.
- Quick, one-handed removal for easy cleaning.
- Dimensions: 5-1/2" L x 4" H x 3-1/4" W.
- 12 volt.

Order No.	Mfg. No. / Description	List Price
236186	(4505-7) 500 GPH Hose Size 3/4" ID	\$67.79 FO-5474000
236198	(4507-7) 750 GPH Hose Size 3/4" ID	\$104.49 FO-4137000
236201	(4511-7) 1,100 GPH Hose Size 1-1/8" ID	\$122.79 FO-5958000

Ultra Bilge Pumpswitches



- Power - on indicator light
- Ignition protected.
- No mercury.
- Positive action, no time delays or electronics.
- Encapsulated 30 amp relay.
- Environmentally safe.
- Klvr klamp for easy mount.
- Patented design provides maximum immunity to clogging, sticking or pump burnout.
- Magnetically operated reed switch control.
- Extra long wire leads with sealed adhesive wall heat shrink wire connectors.
- Wiring instructions permanently stamped on the housing.



ULTRA BILGE PUMPSWITCH SENIOR AND HIGH WATER ALARM

- Includes: Built-in high water alarm sensor at 3-1/2".

Order No.	Mfg. No. / Description	Dimensions	List Price
665000	(UPS-0112V) 12 volt	6-1/4" H x 2-1/2" D	\$218.19 E0-4636100
665005	(UPS-0124V) 24/32 volt	6-1/4" H x 2-1/2" D	\$218.19 E0-4636100

ULTRA BILGE PUMPSWITCH JUNIOR

Order No.	Mfg. No. / Description	Dimensions	List Price
665010	(UPS-0212V) 12 volt	6-1/4" H x 2-1/2" D	\$186.69 E0-2004100
665015	(UPS-0224V) 24/32 volt	6-1/4" H x 2-1/2" D	\$186.69 E0-2004100

ULTRA BILGE PUMPSWITCH MINI

Order No.	Mfg. No. / Description	Dimensions	List Price
665020	(UPS-0612V) 12 volt	4" H x 1-3/4" D	\$186.69 E0-2004100
665025	(UPS-0624V) 24/32 volt	4" H x 1-3/4" D	\$186.69 E0-2004100

- Electronics
- Trolling Motors
- Instruments
- Electrical
- Lighting
- Anchor & Dock
- Safety
- Steering, Controls
- Pumps
- Fuel System
- Seating & Pedestals
- Trailer
- Tops & Covers
- Perform.
- Propellers
- Engine & Care
- Cleaning & Care
- Paint & Paint Acc.
- Fun & Flotation
- Topside Acc.
- Cockpit & Deck
- Hardware, Fasteners
- Camouflage
- Misc.
- Comm.

Rule Combo Bilge Pump and Float Switch



- Includes: **582026** (25D) 500 GPH Bilge Pump and **582646** (35A) Rule-A-Matic Float Switch.
- 3 year warranty on pump and 2 year warranty on float switch.

Order No.	Mfg. No. / Description	List Price	
582014	(25DA-35A) 500 GPH	\$80.79	GO-3145000

Rule Combo Bilge Pump and Float Switch



- Includes: **582000** (24) 360 GPH Bilge Pump and **582646** (35A) Rule-A-Matic Float Switch.
- 3 year warranty on pump and 2 year warranty on float switch.

Order No.	Mfg. No. / Description	List Price	
582076	(24DA-35A) 360 GPH	\$62.19	GO-7614000

Rule ECO-Switches



- An ecologically sound automatic bilge pump control switch.
- Featuring a non-mercury design, the pump operates with simple air pressure.
- There are no moving internal parts, as all wiring is out of the water, which means that there are no submerged electrical connections at all.
- Dimensions: 6" x 2-3/4" x 1-7/8".

Order No.	Mfg. No. / Description	List Price	
582836	(39) 12 volt	\$80.09	GO-6635000
582848	(39-24) 24 volt	\$81.79	GO-0845000

Rule SuperSwitch™ Float Switches



- A 5 year warranty, the non-mercury SuperSwitch is designed for the toughest applications.
- Design includes marine grade 14 gauge "blocked wire", larger float for increased buoyancy, and removable base for easy servicing.
- Design capable of handling pumps drawing up to 20 amps.
- Dimensions: 2-1/4" x 5" x 2".

Order No.	Mfg. No. / Description	List Price	
582662	(37A) Without Fuse Holder	\$62.09	GO-0614000
582660	(37FA) With Fuse Holder	\$64.69	GO-4334000

Rule Rule-A-Matic® Plus™ Float Switches



- Sleek and rugged, the Rule-A-Matic Plus float switch has a strong, fully integrated and impact resistant cover, which protects against debris and jamming.
- 14 gauge highly abrasive resistant marine grade wire, and a built-in test feature.
- Designed for pumps drawing up to 20 amps.
- Dimensions: 3" x 5-3/8" x 2-1/2".
- 2 year warranty.

Order No.	Mfg. No. / Description	List Price	
582698	(40A) Without Fuse Holder	\$53.49	GO-4853000
582696	(40FA) With Fuse Holder	\$55.79	GO-8373000

Rule Rule-A-Matic® Float Switches



- Mercury-free snap switch tested to over one million cycles.
- Designed for pumps drawing up to 14 amps.
- Includes a removable base for easy cleaning and servicing and marine grade "blocked" wire.
- Dimensions: 4-1/2" x 1-1/2" x 2".
- 2 year warranty.

Order No.	Mfg. No. / Description	List Price	
582646	(35A) Without Fuse Holder	\$41.69	GO-3972000
582658	(35FA) With Fuse Holder	\$44.69	GO-4992000

Johnson Pump Automatic Float Switch



- For full automatic bilge pumping operation, connect the automatic switch to a bilge pump.
- Has a time-proven micro switch without mercury.
- When water exceeds the acceptable level, the pump is turned on by a rolling steel ball, which changes the pressure on the micro switch.
- Attaches through the clip on "T-slot" and can be used with 6, 12, 24 or 32 volt systems.

Order No.	Mfg. No. / Description	List Price	
470055	(26014)	\$18.19	GO-9121000

Attwood Automatic Float Switches



- Converts any bilge pump that draws 12 amps (at 12 VDC) or 6 amps (at 24 VDC) or less to fully automatic operation.
- Compact, low profile design that mounts on any surface from horizontal up to a 24° angle.
- Incorporates a reliable and affordable mechanical switch that actuates pump motor at 2" water level.
- Contains no mercury, a "Persistent Toxic Substance," listed as a health hazard in more than 26 states.

Order No.	Mfg. No. / Description	List Price	
236162	(4202-7) 1-3/8" H x 3-7/8" W x 4-1/4" L	\$30.99	F0-9612000
236174	(4201-7) 2-7/8" H x 3-7/8" W x 5-1/4" L w/Cover	\$33.49	F0-4432000

- Electronics
- Trolling Motors
- Instruments
- Electrical
- Lighting
- Anchor & Dock
- Safety
- Steering, Controls
- Pumps
- Fuel System
- Seating & Pedestals
- Trailer
- Tops & Covers
- Perform.
- Propellers
- Engine & Care
- Cleaning & Care
- Paint & Paint Acc.
- Fun & Flotation
- Topside Acc.
- Cockpit & Deck
- Hardware, Fasteners
- Camouflage
- Misc.
- Comm.

Marpac Premier Electronic Bilge Switch



- Solid state automatic bilge water detection.
- No moving parts, completely enclosed design.
- Sensors only activate when exposed to water.
- Works with both fresh and salt water.
- Multiple mounting options.
- Ignition protected - ISO 8846:1990.

Order No.	Description	List Price	
7-2228	Electronic Bilge Switch	\$36.99	G0-8742000

Johnson Pump Ultima Switch™ - Electronic Automatic Switch



- Patented Mirus field effect detector cells producing micro-electrical field that detect disruptions caused by water and fluids.
- Detector cells are totally sealed and are never in contact with the water, will not corrode and are not affected by oil or foreign debris.
- No moving parts, totally sealed solid state electronics and field detectors, no mercury and no exposed sensors eliminate corrosion possibilities and makes the Ultima Switch environmentally sensitive.
- Activates at a 2" fluid level and deactivates at a 3/4" fluid level.
- A 3 second delay prevents false starts.
- Ultima Switch is rated to handle pumps up to 20 amp at 12 or 24 volt.

Order No.	Mfg. No. / Description	List Price	
471365	(36303)	\$51.19	G0-0343000

Rule High-Water Bilge Alarms



- Consists of a Rule-A-Matic Plus Float Switch and an in-dash gauge that features both a visual and an audible 85 db alarm.
- Allows an unmanned compartment to be constantly monitored.
- For additional compartments add additional Rule Float Switches.
- Complies with CFR 182.530 which requires a visual and audible alarm in each unmanned space on commercial vessels at least 26' in length.

Order No.	Mfg. No. / Description	List Price	
581505	(33ALA) 12 volt	\$88.49	G0-9295000
581517	(32ALA) 24 volt	\$94.79	G0-1536000
581531	(M-1507) Alarm Only	\$67.69	G0-5354000

Johnson Pump Electro-Magnetic Float Switch



- Compact mechanical switch offers a combination of reliable solid state electronics and a sealed float switch.
- False start prevention, no mercury, high impact plastic and encapsulated electronics adds up to dependability.
- Activates pump at 2" water level, deactivates pump at 3/4" water level.
- Designed to attach to Johnson Pump Cartridge Bilge Pumps.

Order No.	Mfg. No. / Description	List Price	
471363	(36152) 12 volt	\$44.79	G0-1003000

Groco AS-100 Bilge Pump Switch



- Switch turns bilge pump off and on by sensing changes in pressure (caused by rising or falling bilge water level) in its air tube. No floats to stick or fill with water.
- Approximate levels are "ON" at 2-3/4" of bilge level and "OFF" at 1".
- Use with a pump that draws up to 10 amps running continuously or up to 20 amps running intermittently.

Order No.	Mfg. No. / Description	List Price	
374500	(AS-100)	\$122.59	G0-4128000

Johnson Pump Bilge Alert™ - High Water Alarm



- High water alarm featuring digital technology using the patented Mirus field effect.
- Totally sealed fluid detector are never in contact with water, will not corrode and are not affected by oil or debris.
- Bilge alert detects water and sends a signal (3 second delay for sloshing) to the alarm and switch conveniently mounted on a panel.
- Three way rocker switch allows alarm to be tested, turned off and armed.
- 12 volt.

Order No.	Mfg. No. / Description	List Price	
471351	(72303) Includes Sensor	\$93.89	G0-1926000
471353	(72303-001) Includes Ultima Switch	\$87.49	G0-2685000

- Electronics
- Trolling Motors
- Instruments
- Electrical
- Lighting
- Anchor & Dock
- Safety
- Steering, Controls
- Pumps**
- Fuel System
- Seating & Pedestals
- Trailer
- Tops & Covers
- Perform.
- Propellers
- Engine & Care
- Cleaning & Care
- Paint & Paint Acc.
- Fun & Flotation
- Topside Acc.
- Cockpit & Deck
- Hardware, Fasteners
- Camouflage
- Misc.
- Comm.

Johnson Pump Panel Bilge Pump Switches

SPXFLOW
Johnson Pump

471361



- Matt black finish has integrated fuse holder and operating light.
- Just push the button for the manual or automatic bilge pumping.
- The automatic feature operates in combination with the automatic bilge switches or the electronic float switch.
- Dimensions: 2.99" x 2.17" x 1.57" depth.
- 12 volt.

Order No.	Mfg. No. / Description	List Price	
471361	(82004) 2-Way "On-Off"	\$30.99	GO-6702000
471362	(82044) 3-Way "On-Auto-Off"	\$41.59	GO-7872000

Boater Sports 3-Way Bilge Pump Switch



- Marine grade tinned wire.
- Corrosion free aluminum panel.
- 3 position toggle switch - "On-Off-Auto".
- LED indicator light.
- 10 amp breaker.
- Dimensions: 3-1/4" x 2".

Order No.	Mfg. No. / Description	List Price	
1-57444	(57444)	\$24.99	HO-9941000

Rule 2-Way Panel Switch

rule
a xylem brand



- For any manually operated system.
- Black stainless steel panel.
- Simple "on" or "off" toggle provides fingertip control.
- Dimensions: 2-1/4" x 2".

Order No.	Mfg. No. / Description	List Price	
582759	(49) 12/24/32 volt	\$30.49	GO-3402000

Rule 3-Way Panel Switch - Standard

rule
a xylem brand



- Black stainless steel panel.
- Controls any pump equipped with an automatic float switch.
- Toggle has 3 position: Automatic, Off or Manual.
- Dimensions: 2-1/4" x 2".

Order No.	Mfg. No. / Description	List Price	
582735	(45) 12/24/32 volt	\$31.59	GO-7112000

Rule 3-Way Panel Lighted Switches - Deluxe

rule
a xylem brand



- Black stainless steel with a red indicator light and fuse holder.
- Toggle has 3 positions: Automatic, Off and Manual. The "manual" position has a "fail-safe" spring return to "off".
- Dimensions: 2" x 3-1/4".

Order No.	Mfg. No. / Description	List Price	
582709	(41) 12 volt	\$39.89	GO-3762000
582711	(42) 24/32 volt	\$44.49	GO-1892000

Rule 3-Way Panel Lighted Rocker Switch

rule
a xylem brand



- For use with any automatically controlled pump.
- This unit features a black plastic panel, a built-in fuse holder and an internally lighted rocker switch with 3 positions (automatic, off or manual) with the Rule "fail-safe" spring return to "off" from the "manual" position.
- Dimensions: 2-7/8" x 2-3/8".

Order No.	Mfg. No. / Description	List Price	
582713	(43) 12 volt	\$40.89	GO-0472000
582723	(44) 24 volt	\$52.89	GO-4453000

Jabsco Medium and Heavy Duty Bilge Pumps

JABSCO
a xylem brand



- Fully serviceable, bilge pump.
- Allows mounting above wet bilges.
- Diaphragm design allows extended dry running.
- Self-priming.
- Corrosive resistant materials. Large vibration absorbing pads.
- Connections for 3/4" ID hose.
- Complete with Pumpgard strainer.
- 12 volt.

Order No.	Mfg. No. / Description	List Price	
414235	(36680-2000) 5.5 GPM	\$602.69	GO-0830400
414261	(36600-0000) 7.9 GPM	\$674.59	GO-8915400
414350	(36200-0000) Spare Pumpgard Strainer	\$27.39	GO-5381000

Jabsco Bilge Pump Service Kit

JABSCO
a xylem brand



- Kit includes: Replacement belt, diaphragm, valves and pulsation dampeners to restore the performance of old or worn out pumps.
- For use with 414261 (36600-0000) Bilge Pump.

Order No.	Mfg. No. / Description	List Price	
416026	(30124-0000)	\$161.69	GO-3380100

Jabsco Motor Kit

JABSCO
a xylem brand



- Spare or replacement motor for Jabsco 12 volt Bilge Pumps.
- For models: 34600, 36600, 36800 and 36900.
- 12 volt.

Order No.	Mfg. No. / Description	List Price	
416138	(30200-0000)	\$196.99	GO-8913100

- Electronics
- Trolling Motors
- Instruments
- Electrical
- Lighting
- Anchor & Dock
- Safety
- Steering, Controls
- Pumps
- Fuel System
- Seating & Pedestals
- Trailer
- Tops & Covers
- Perform.
- Propellers
- Engine & Care
- Cleaning & Care
- Paint & Paint Acc.
- Fun & Flotation
- Topside Acc.
- Cockpit & Deck
- Hardware, Fasteners
- Camouflage
- Misc.
- Comm.

Jabsco Flexible Impeller Pedestal Pump



- 4.4 GPM.
- Seal: Nitrile lip type.
- Sealed ball bearings.
- Fitting: 3/8" NPT internal.
- Self-priming up to 4.9' vertical lift.

Order No.	Mfg. No. / Description	List Price
417898	(2620-1101) Pump w/Neoprene Impeller	\$387.19

REPLACEMENT PARTS

Order No.	Mfg. No. / Description	List Price
418500	(18673-0001-P) Impeller - Neoprene	\$48.79
422232	(11830-0000) End Cover	\$18.89
422244	(18753-0125) End Cover O-ring	\$10.99
422256	(18753-0121) End Cover / Cam Screw Kit	\$16.49
422268	(2907-0000) Brass Cam	\$24.09
422270	(92700-0050) Water Lip Seal	\$18.89

Jabsco Flexible Impeller Pedestal Pump



- 17.8 GPM.
- Seal: Mechanical face seal or lip type.
- Shielded ball bearings.
- Fitting: 1" NPT internal.
- Self-priming up to 7.8' vertical lift.

Order No.	Mfg. No. / Description	List Price
417940	(777-9001) Pump w/Neoprene Impeller	\$454.59

REPLACEMENT PARTS

Order No.	Mfg. No. / Description	List Price
418359	(17937-0001-P) Impeller - Neoprene	\$43.69
418725	(11831-0000) End Cover	\$28.49
418878	(890-0000) End Cover O-ring	\$4.19
423397	(91003-0010) End Cover / Cam Screw Kit	\$17.59
423537	(934-0000) Brass Cam	\$37.39
422460	(91004-0090) Cam Screw	\$9.49
422484	(4156-0000) Wear Plate	\$18.89
423549	(96080-0080) Mechanical Seal	\$77.89
422511	(3181-0000) Slinger	\$18.99
422523	(92600-0060) Bearing	\$125.39
422535	(18724-0000) Retaining Ring - Large	\$15.69
422547	(18713-0000) Retaining Ring - Small	\$8.39
422559	(9215-0010) Shaft Key	\$8.39

REPLACEMENT PARTS FOR OLDER MODELS (777-)

Order No.	Mfg. No. / Description	List Price
423498	(92700-0060) Water Lip Seal	\$28.19
423424	(913-0000) Bearing Oil Seal	\$17.79

Jabsco Flexible Impeller Pedestal Pump



- 8.9 GPM.
- Seal: Lip seal, nitrile.
- Sealed ball bearings.
- Fitting: 1/2" NPT.
- Self-priming up to 7.8' vertical lift.

Order No.	Mfg. No. / Description	List Price
417902	(1673-1001) Pump w/Neoprene Impeller	\$419.39

REPLACEMENT PARTS

Order No.	Mfg. No. / Description	List Price
418309	(1210-0001-P) Impeller - Neoprene	\$39.59
418311	(1210-0003-P) Impeller - Nitrile	\$39.59
422357	(11836-0000) End Cover	\$39.49
422369	(18753-0133) End Cover O-ring	\$13.19
422371	(18753-0134) End Cover / Cam Screw Kit	\$12.59
422383	(490-0001) Brass Cam	\$42.89
423549	(96080-0080) Mechanical Seal	\$77.89
422408	(3286-0000) Slinger	\$13.59
422559	(9215-0010) Shaft Key	\$8.39

Jabsco Flexible Impeller Pedestal Pumps



- 44.4 GPM.
- Seal: Carbon/ceramic face type.
- Pre-lubricated double row ball bearing.
- Fitting: 1-1/4" NPT Internal.
- Self-priming up to 7.8' vertical lift.

Order No.	Mfg. No. / Description	List Price
417953	(6400-0004) Pump w/Neoprene Impeller	\$719.49
417954	(6400-1051) Short Shaft f/Caterpillar Engines	\$663.99

REPLACEMENT PARTS

Order No.	Mfg. No. / Description	List Price
418424	(17935-0001-P) Impeller - Neoprene	\$75.19
418448	(836-0003-P) Impeller - Nitrile	\$66.09
418738	(12062-0000) End Cover	\$91.39
418888	(816-0000) End Cover O-ring	\$9.49
423412	(91005-0040) End Cover / Cam Screw Kit	\$8.39
423373	(834-0001) Brass Cam	\$56.89
416594	(2574-0000) Wear Plate	\$32.69
423234	(6407-0010) Water Seal	\$70.09
422511	(3181-0000) Slinger	\$18.99
423335	(817-0000) Inner Bearing - Lip Seal	\$29.29
422600	(92600-0040) Bearing	\$168.19
422612	(18712-0000) Retaining Ring - Large	\$19.89
422624	(18711-0000) Retaining Ring - Small	\$22.99
423347	(818-0000) Outer Bearing - Lip Seal	\$39.69
422650	(9214-0001) Shaft Key	\$16.79

Jabsco Flexible Impeller Pedestal Pump



Order No.	Mfg. No. / Description	List Price
417964	(7420-0004) Pump w/Neoprene Impeller	\$936.39

REPLACEMENT IMPELLERS

Order No.	Mfg. No. / Description	List Price
418424	(17935-0001-P) Impeller - Neoprene	\$75.19
418448	(836-0003-P) Impeller - Nitrile	\$66.09

- 44.4 GPM.
- Seal: Carbon/ceramic face type.
- Pre-lubricated double row ball bearing.
- Fitting: 1-1/4" NPT Internal.
- Self-priming up to 7.8' vertical lift.

- Electronics
- Trolling Motors
- Instruments
- Electrical
- Lighting
- Anchor & Dock
- Safety
- Steering, Controls
- Pumps
- Fuel System
- Seating & Pedestals
- Trailering
- Tops & Covers
- Perform.
- Propellers
- Engine & Care
- Cleaning & Care
- Paint & Paint Acc.
- Fun & Flotation
- Topside Acc.
- Cockpit & Deck
- Hardware, Fasteners
- Camouflage
- Misc.
- Comm.



Jabsco Flexible Impeller Pedestal Pump



- 60 GPM.
- Seal: Carbon/ceramic mechanical type.
- Bearings: Twin single row, ball type.
- Fitting: 2" NPT internal.
- Self-priming up to 7.8' vertical lift.

Order No.	Mfg. No. / Description	List Price
417999	(18370-0000) Pump w/Neoprene Impeller	\$1,737.29 GO-8936110

REPLACEMENT PARTS

Order No.	Mfg. No. / Description	List Price
418457	(17936-0001-P) Impeller - Neoprene	\$117.79 GO-2987000
418738	(12062-0000) End Cover	\$91.39 GO-3216000
418888	(816-0000) End Cover O-ring	\$9.49 GO-6360000
423412	(91005-0040) End Cover / Cam Screw Kit	\$8.39 GO-2650000
423272	(6988-0000) Brass Cam	\$75.59 GO-5605000
416594	(2574-0000) Wear Plate	\$32.69 HO-1691000
423246	(6408-0000) Water Seal	\$73.09 GO-7984000
422511	(3181-0000) Slinger	\$18.99 GO-2721000
422775	(92701-0180) Inner Bearing - Lip Seal	\$18.69 HO-1211000
422787	(92600-0260) Bearing	\$74.19 GO-1794000
422802	(18725-0000) Retaining Ring - Large	\$28.19 GO-9881000
423347	(818-0000) Outer Bearing - Lip Seal	\$39.69 GO-9562000
422650	(9214-0001) Shaft Key	\$16.79 GO-5211000

Jabsco Cummins Vortex K38 Engine Cooling Pump



- Flow rate: 400 GPM.
- Fits: Cummins Vortex K38, KTA38, KTA50; Cummins 3393018, 4314820.

Order No.	Mfg. No. / Description	List Price
424159	(15780-0000) Pump	\$10,092.59 GO-4026760

REPLACEMENT PARTS

Order No.	Mfg. No. / Description	List Price
425620	(15278-1000) Flapper Assembly	\$339.89 GO-3772200
425618	(15299-1000) Impeller	\$287.59 GO-9629100
425579	(15296-1000) Wear Plate	\$669.39 HO-3610400
425581	(15297-1010) Cam Liner	\$690.79 HO-7441400
425606	(15295-1010) Shaft	\$624.99 HO-9947300
425644	(18753-0616) Lip Seal - Large	\$124.99 GO-4738000
422775	(92701-0180) Inner Bearing - Lip Seal	\$18.69 HO-1211000
425555	(96080-0371) Water Seal Cat/Cummins	\$118.19 HO-1907000
425656	(18753-0007) Bearing	\$130.39 GO-6378000
425594	(15294-1010) Wear Ring Only	\$447.09 HO-5286200
425593	(15294-1020) Wear Ring Kit	\$624.99 GO-4781400
425668	(15298-1020) Bronze Impeller Kit	\$1,409.59 GO-3444900
425825	(90202-0000) Minor Service Kit	\$1,153.29 HO-7919600
425682	(99202-1000) Major Service Kit	\$3,041.99 GO-3183020

Jabsco Replacement Parts for Detroit Diesel Engine Cooling Pump (17050-0001)

Order No.	Mfg. No. / Description	List Price
418725	(11831-0000) End Cover	\$28.49 GO-9091000
418878	(890-0000) End Cover O-ring	\$4.19 GO-1820000
423397	(91003-0010) End Cover / Cam Screw Kit	\$17.59 GO-9711000
423537	(934-0000) Brass Cam	\$37.39 FO-7162000
422460	(91004-0090) Cam Screw	\$9.49 GO-6360000
425404	(7867-0000) Brass Cam with Pin	\$44.99 GO-4103000
425416	(91003-0020) Cam Screw	\$13.59 GO-1190000

Jabsco Cummins K19 Engine Cooling Pump



- Flow rate: 125 GPM.
- Flange mount.
- Port type: 2-1/2" flange.
- Fits: Cummins KTA19, 3866609.

Order No.	Mfg. No. / Description	List Price
424109	(18770-0003) Pump	\$4,644.19 GO-1611130

REPLACEMENT PARTS

Order No.	Mfg. No. / Description	List Price
425834	(18789-0001) Impeller - Neoprene	\$244.19 GO-1636100
425822	(18784-1000) End Cover	\$680.89 GO-0265400
425846	(18753-0434) End Cover O-ring	\$10.59 GO-0170000
425860	(X3001-180F) End Cover Screws	\$7.09 GO-5740000
425858	(18785-0000) Cam Liner/O-ring	\$75.59 GO-5605000
425872	(18787-0000) Wear Plate	\$243.49 GO-4136100
425555	(96080-0371) Water Seal Cat/Cummins	\$118.19 HO-1907000
425884	(18753-0530) Slinger O-ring	\$18.69 GO-2521000
422775	(92701-0180) Inner Bearing - Lip Seal	\$18.69 HO-1211000
425909	(18753-0526) Bearing	\$177.69 GO-5091100
425911	(18753-0527) Roller Bearing	\$257.69 GO-5627100

Jabsco Detroit Diesel Engine Cooling Pump



- Flow rate: 60 GPM.
- Self-priming up to 7.8' vertical lift.
- Port type: 2-1/2" flange.
- Fits: Detroit Diesel V-71, V-92, 23507475, 23507476, 23507477, 23507973; Caterpillar D-336, D-343, D-353, 3N1888.

Order No.	Mfg. No. / Description	List Price
424058	(17360-1001) Pump	\$3,614.59 HO-5786120

REPLACEMENT PARTS

Order No.	Mfg. No. / Description	List Price
425492	(17370-0001-P) Impeller	\$146.09 GO-8879000
425505	(17378-1000) End Cover	\$219.29 GO-2964100
425517	(17365-1000) End Cover Gasket	\$21.99 GO-3741000
423412	(91005-0040) End Cover / Cam Screw Kit	\$8.39 GO-2650000
425529	(17374-1000) Cam Liner	\$288.59 FO-1020200
425531	(17372-1000) Wear Plate	\$101.99 GO-3386000
425555	(96080-0371) Water Seal Cat/Cummins	\$118.19 HO-1907000
425543	(18754-1004) O-ring	\$5.89 GO-5930000
422775	(92701-0180) Inner Bearing - Lip Seal	\$18.69 HO-1211000
425566	(18752-0000) Bearing	\$56.39 GO-8773000

SPECIAL HANDLING MAY APPLY



Electronics
Trolling Motors
Instruments
Electrical
Lighting
Anchor & Dock
Safety
Steering, Controls

Pumps
Fuel System
Seating & Pedestals
Trailer
Tops & Covers
Perform.
Propellers
Engine & Care
Cleaning & Care
Paint & Paint Acc.
Fun & Flotation

Topside Acc.
Cockpit & Deck
Hardware, Fasteners
Camouflage
Misc.
Comm.

Jabco Electro-Magnetic Clutch Pump



- Flow rate: 23 GPM @ 1,750 RPM.
- Self-priming from dry up to 7.8'.
- Port type: 1" NPT.

Order No.	Mfg. No. / Description	List Price
417778	(11860-0005) Pump	\$914.29

REPLACEMENT PARTS

Order No.	Mfg. No. / Description	List Price
418448	(836-0003-P) Impeller - Nitrile	\$66.09
418725	(11831-0000) End Cover	\$28.49
418878	(890-0000) End Cover O-ring	\$4.19
423397	(91003-0010) End Cover / Cam Screw Kit	\$17.59
423537	(934-0000) Brass Cam	\$37.39
423690	(7868-0000) Wear Plate	\$18.89
423549	(96080-0080) Mechanical Seal	\$77.89
425430	(3180-0000) Slinger O-ring	\$12.59
423424	(913-0000) Bearing Oil Seal	\$17.79
423703	(92600-0540) Bearing	\$68.99
422535	(18724-0000) Retaining Ring - Large	\$15.69
422547	(18713-0000) Retaining Ring - Small	\$8.39
423640	(98022-0500) Field Coil - 12 volt	\$235.19
423664	(92300-0030) Clutch Assembly - 12 volt	\$448.09

Jabco Electro-Magnetic Clutch Pump

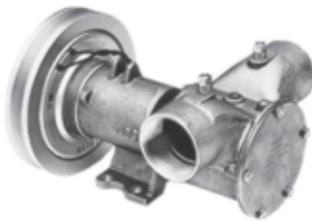

- Flow rate: 83 GPM @ 1,750 RPM.
- Self-priming from dry up to 7.8'.
- Port type: 2" NPT.

Order No.	Mfg. No. / Description	List Price
417838	(18330-0000) Pump	\$1,852.39

REPLACEMENT PARTS

Order No.	Mfg. No. / Description	List Price
418465	(6760-0003-P) Impeller - Nitrile	\$216.69
418738	(12062-0000) End Cover	\$91.39
418888	(816-0000) End Cover O-ring	\$9.49
423412	(91005-0040) End Cover / Cam Screw Kit	\$8.39
423272	(6988-0000) Brass Cam	\$75.59
416594	(2574-0000) Wear Plate	\$32.69
423246	(6408-0000) Mechanical Seal	\$73.09
422775	(92701-0180) Inner Bearing - Lip Seal	\$18.69
422787	(92600-0260) Bearing	\$74.19
422802	(18725-0000) Retaining Ring - Large	\$28.19
423777	(11876-0000) Clutch Adapter	\$169.19
423640	(98022-0500) Field Coil - 12 volt	\$235.19
423664	(92300-0030) Clutch Assembly - 12 volt	\$448.09

Jabco Manual Clutch Pump

- Flow rate: 60 GPM @ 1,500 RPM.
- Self-priming from dry up to 7.8'.
- Port type: 2" flange

Order No.	Mfg. No. / Description	List Price
417697	(51270-9013) Pump	\$1,940.69

REPLACEMENT PARTS

Order No.	Mfg. No. / Description	List Price
418465	(6760-0003-P) Impeller - Nitrile	\$216.69

Jabco Electro-Magnetic Clutch Pump



- Flow rate: 62 GPM @ 1,750 RPM.
- Self-priming from dry up to 7.8'.
- Port type: 1-1/4" NPT.

Order No.	Mfg. No. / Description	List Price
417802	(11870-0005) Pump	\$1,731.79

REPLACEMENT PARTS

Order No.	Mfg. No. / Description	List Price
418465	(6760-0003-P) Impeller - Nitrile	\$216.69
418738	(12062-0000) End Cover	\$91.39
418888	(816-0000) End Cover O-ring	\$9.49
423412	(91005-0040) End Cover / Cam Screw Kit	\$8.39
423373	(834-0001) Brass Cam	\$56.89
416594	(2574-0000) Wear Plate	\$32.69
423234	(6407-0010) Water Seal	\$70.09
422511	(3181-0000) Slinger	\$18.99
423335	(817-0000) Inner Bearing - Lip Seal	\$29.29
422600	(92600-0040) Bearing	\$168.19
422612	(18712-0000) Retaining Ring - Large	\$19.89
422624	(18711-0000) Retaining Ring - Small	\$22.99
423777	(11876-0000) Clutch Adapter	\$169.19
423640	(98022-0500) Field Coil - 12 volt	\$235.19
423664	(92300-0030) Clutch Assembly - 12 volt	\$448.09

Jabco Manual Clutch Pump



- Flow rate: 23 GPM @ 1,750 RPM.
- Self-priming from dry up to 7.8'.
- Port type: 1-1/4" NPT.

Order No.	Mfg. No. / Description	List Price
417687	(6590-0005) Pump	\$1,783.49

REPLACEMENT PARTS

Order No.	Mfg. No. / Description	List Price
418448	(836-0003-P) Impeller - Nitrile	\$66.09
418738	(12062-0000) End Cover	\$91.39
418888	(816-0000) End Cover O-ring	\$9.49
423412	(91005-0040) End Cover / Cam Screw Kit	\$8.39
423373	(834-0001) Brass Cam	\$56.89
416594	(2574-0000) Wear Plate	\$32.69
423234	(6407-0010) Water Seal	\$70.09
422511	(3181-0000) Slinger	\$18.99
423335	(817-0000) Inner Bearing - Lip Seal	\$29.29
422600	(92600-0040) Bearing	\$168.19
422612	(18712-0000) Retaining Ring - Large	\$19.89
422624	(18711-0000) Retaining Ring - Small	\$22.99



- Electronics
- Trolling Motors
- Instruments
- Electrical
- Lighting
- Anchor & Dock
- Safety
- Steering, Controls
- Pumps
- Fuel System
- Seating & Pedestals
- Trailering
- Tops & Covers
- Perform.
- Propellers
- Engine & Care
- Cleaning & Care
- Paint & Paint Acc.
- Fun & Flotation
- Topside Acc.
- Cockpit & Deck
- Hardware, Fasteners
- Camouflage
- Misc.
- Comm.



Order No.	Impeller No.	Drive Material	Type	No. of Blades	Diameter	Width	Shaft Dia.	Insert Material	Remarks	List Price
SILHOUETTE A										
	(1414-0001)	Neoprene	4	6	1-1/4"	15/32"	5/16"	Brass		
415364	(1414-0003-P)	Nitrile	4	6	1-1/4"	15/32"	5/16"	Brass		\$33.49 GO-4422000
	(12104-0001)	Neoprene	2	6	1-1/4"	15/32"	5/16"	Brass	Onan (Use 6-32 x 5/8 Hdl's Screw)	
	(21414-0001-P)	Neoprene	4	6	1-1/4"	15/32"	5/16"	Brass		
SILHOUETTE B										
418233	(14750-0001)	Neoprene	4	8	1-1/4"	15/32"	5/16"	Brass		\$41.79 GO-0082000
418246	(14750-0003-P)	Nitrile	4	8	1-1/4"	15/32"	5/16"	Brass		\$39.59 GO-3562000
SILHOUETTE C										
	(14609-0001)	Neoprene	4	6	1-1/4"	15/32"	5/16"	Brass		
	(14609-0003)	Neoprene	4	6	1-1/4"	15/32"	5/16"	Brass		
	(14787-0001)	Neoprene	4	6	1-1/4"	15/32"	5/16"	Plastic	Was SS Insert	
SILHOUETTE D										
418497	(4528-0001-P)	Neoprene	1 or 2	6	1-9/16"	3/4"	3/8"	Brass	Was AL -24	\$51.39 HO-3803000
	(4528-0003-P)	Nitrile	1 or 2	6	1-9/16"	3/4"	3/8"	Brass	Was AL -24 - 37	
415353	(17255-0003-P)	Nitrile	—	6	1-9/16"	3/4"	1/4"	None	Impeller Moulded on Shaft	\$31.49 GO-0112000
418700	(22405-0001-P)	Neoprene	1	6	1-9/16"	3/4"	15/32"	Brass		\$28.19 GO-9881000
SILHOUETTE F										
	(9200-0001)	Neoprene	4	10	1-19/32"	3/4"	5/16"	Plastic	Was Brass Insert	
	(9200-0003)	Nitrile	4	10	1-19/32"	3/4"	5/16"	Plastic	Was Brass Insert	
	(9200-0021)	Neoprene	4	10	1-19/32"	3/4"	5/16"	Brass		
418601	(9200-0023-P)	Nitrile	4	10	1-19/32"	3/4"	5/16"	Brass		\$54.89 GO-8763000
SILHOUETTE G										
	(653-0001-P)*	Neoprene	1	6	2"	7/8"	15/32"	Brass		
	(673-0001-P)* †	Neoprene	1 or 2	6	2"	7/8"	1/2"	Brass		
	(4527-0003B)	Nitrile	2	6	2"	7/8"	5/16"	None	Was B-12	
	(5616-0001-P)	Neoprene	6	6	2"	7/8"	1/2"	Brass		
	(7273-0001-P)	Neoprene	4	6	2"	7/8"	5/16"	Plastic		
418536	(7273-0003-P)	Nitrile	4	6	2"	7/8"	5/16"	Plastic		\$43.19 HO-1952000
	(22799-0001-P)	Neoprene	3	6	2"	7/8"	1/2"	Brass		
SILHOUETTE H										
418284	(6303-0001-P)	Neoprene	4	6	2"	7/8"	5/16"	Plastic		\$30.29 GO-9202000
418295	(6303-0003-P)	Nitrile	4	6	2"	7/8"	5/16"	Plastic		\$29.49 GO-6791000
418285	(6303-0007-P)	Urethane	4	6	2"	7/8"	5/16"	Plastic		\$49.79 GO-6333000
	(17486-0001)	Neoprene	6	6	2"	7/8"	1/2"	Brass	Brass Extended Drive Cup	
SILHOUETTE I										
	(18653-0001)*	Neoprene	1	10	2"	7/8"	15/32"	Brass	Johnson 810 B	
418500	(18673-0001)*	Neoprene	1 or 2	10	2"	7/8"	1/2"	Brass		\$48.79 GO-9623000
	(18673-0003)*	Nitrile	1 or 2	10	2"	7/8"	1/2"	Brass		
SILHOUETTE K										
418309	(1210-0001-P)	Neoprene	7	12	2-1/4"	1-1/4"	5/8"	Brass		\$39.59 GO-3562000
418311	(1210-0003-P)	Nitrile	7	12	2-1/4"	1-1/4"	5/8"	Brass		\$39.59 GO-3562000
	(4568-0001-P)	Neoprene	3	12	2-1/4"	1-1/4"	5/8"	Brass	Replaces C-12	
	(4568-0003-P)	Nitrile	3	12	2-1/4"	1-1/4"	5/8"	Brass		
	(5929-0001-P)	Neoprene	6	12	2-1/4"	1-1/4"	1/2"	Brass	SS Extended Drive Cup	
418347	(5929-0003-P)	Nitrile	6	12	2-1/4"	1-1/4"	1/2"	Brass	SS Extended Drive Cup	\$106.59 GO-2417000
	(13554-0001-P)	Neoprene	7	12	2-1/4"	1-29/32"	5/8"	Brass	Johnson 812 B	
	(14281-0001-P)	Neoprene	5	12	2-1/4"	1-1/4"	5/8"	Plastic		
	(22120-0001)	Neoprene	7	12	2-1/4"	2"	5/8"	Brass	Volvo V-8	
SILHOUETTE L										
418562	(3085-0001-P)	Neoprene	7	10	2-1/4"	1-1/4"	1/2"	Brass	SS Extended Drive Cup (Sanitary)	\$77.29 GO-8715000

- Electronics
- Trolling Motors
- Instruments
- Electrical
- Lighting
- Anchor & Dock
- Safety
- Steering, Controls
- Pumps**
- Fuel System
- Seating & Pedestals
- Trailering
- Tops & Covers
- Perform.
- Propellers
- Engine & Care
- Cleaning & Care
- Paint & Paint Acc.
- Fun & Flotation
- Topside Acc.
- Cockpit & Deck
- Hardware, Fasteners
- Camouflage
- Misc.
- Comm.

*653-Series impellers are not interchangeable with 673-Series and 18653-Series impellers are not interchangeable with 18673-Series.
 The shaft diameters are different.
 †673-Series impellers may be replaced with the newer 18673-Series.



Freshwater Exclusive



Saltwater Exclusive

Jabsco Flexible Impellers

551

Pumps

Order No.	Impeller No.	Drive Material	Type	No. of Blades	Diameter	Width	Shaft Dia.	Insert Material	Remarks	List Price
SILHOUETTE M										
418361	(920-0001-P)	Neoprene	7	8	2-9/16"	2"	5/8"	Brass		\$42.69 GO-0682000
418373	(920-0003-P)	Nitrile	7	8	2-9/16"	2"	5/8"	Brass		\$43.89 GO-1492000
	(4598-0001-P)	Neoprene	3	8	2-9/16"	2"	5/8"	Brass	Was D-12	
	(4598-0003-P)	Nitrile	3	8	2-9/16"	2"	5/8"	Brass	Was D-12-37	
418412	(6056-0003-P)	Nitrile	6	8	2-9/16"	2"	5/8"	Brass	SS Extended Drive Cup	\$188.89 HO-3331100
418599	(11979-0001-P)	Neoprene	7	8	2-9/16"	1-7/16"	5/8"	Brass		\$57.49 GO-2583000
	(17018-0001-P)	Neoprene	7	8	2-9/16"	3"	5/8"	Brass		

SILHOUETTE O										
418435	(836-0001-P)	Neoprene	7	9	3-3/4"	2-1/2"	1"	Brass		\$69.79 GO-6764000
418448	(836-0003-P)	Nitrile	7	9	3-3/4"	2-1/2"	1"	Brass		\$66.09 GO-8244000
	(6760-0001B)	Neoprene	7	9	3-3/4"	3-1/2"	1"	Brass		
418465	(6760-0003-P)	Nitrile	7	9	3-3/4"	3-1/2"	1"	Brass		\$216.69 GO-8154100

SILHOUETTE Q										
425492	(17370-0001-P)	Neoprene	5	12	3-3/4"	3-1/2"	1"	Plastic		\$146.09 GO-8879000
418424	(17935-0001-P)	Neoprene	7	12	3-3/4"	2-1/2"	1"	Brass	Alternative to 836-0001	\$75.19 GO-8305000
418457	(17936-0001-P)*	Neoprene	7	12	3-3/4"	3-1/2"	1"	Brass	Alternative to 6760-0001	\$117.79 GO-2987000
	(17938-0001-P)	Neoprene	7	12	3-3/4"	3-3/4"	1"	Brass	U.K. Equivalent to 17936-0001	

SILHOUETTE R										
	(17240-0001B)	Neoprene	7	9	4-5/8"	3-1/2"	1"	Brass		
	(18786-0001B)	Neoprene	5	9	4-5/8"	3-1/2"	1"	Plastic		
425834	(18789-0001)	Neoprene	7	9	4-5/8"	3-1/2"	1"	Brass	Replaces UK 17240-0001	\$244.19 GO-1636100

SILHOUETTE U										
	(2999-0001B)	Neoprene	7	13	5"	4"	1-1/2"	Brass		

SILHOUETTE W										
423361	(18838-0001-P)	Neoprene	3	12	2-7/16"	1-1/4"	5/8"	Brass	Replaces Sherwood 9959 Impeller	\$43.69 GO-7292000

SILHOUETTE X										
418664	(18948-0001-P)	Neoprene	3	12	2-9/16"	1-5/8"	5/8"	Brass	Replaces Sherwood 10615 Imp.	\$49.79 GO-6333000

SILHOUETTE Y										
418359	(17937-0001-P)	Neoprene	7	10	2-9/16"	2"	5/8"	Brass	Replaces 920-0001	\$43.69 GO-7292000
	(17937-0003-P)	Nitrile	7	10	2-9/16"	2"	5/8"	Brass		
418637	(17954-0001-P)	Neoprene	4	10	2-9/16"	2"	3/4"	Brass	Mercury Replacement	\$50.19 GO-3633000
418384	(17956-0001-P)	Neoprene	6	10	2-9/16"	2"	5/8"	Brass	SS Drive Cup, Replaces 6056-0001	\$136.09 GO-8119000
	(18327-0001-P)	Neoprene	3	10	2-9/16"	2"	5/8"	Brass	Replaces Sherwood 15000 Impeller	

SILHOUETTE Z										
415186	(30919-0001)	Neoprene	5	12	3-1/16"	3"	13/16"	Brass		\$96.09 GO-8346000

SILHOUETTE CC										
	(31130-0061-P)	Neoprene	7	10	2-19/32"	2-11/16"	5/8"	Brass	Mercury Replacement (HINO) (Replaces Quicksilver 47-831311350)	

SILHOUETTE GG										
418613	(18958-0001-P)	Neoprene	3	12	3-1/4"	2-57/64"	25/32"	Brass	Replaces Sherwood 17000 Impeller	\$109.69 GO-9437000

† = For Low Temperature to 27° F - 120° F max.

* = The 17936-0001 Impeller may be used to replace an English Model 21676-0001.

Jabsco Flexible Impeller Removal Tools



- The easiest way to remove impellers, especially when the pump is mounted in tight and cramped conditions.
- Manufactured from corrosion resistant cast aluminum and stainless steel.

Order No.	Mfg. No.	For Impellers:	List Price
418219	(50070-0040)	Up to 2-1/2"	\$140.99 GO-6449000
418221	(50070-0200)	2-1/2" to 4-1/2"	\$173.79 HO-7240100

Drive Type

1	SLOTTED SHAFT PIN DRIVE		5	DOUBLE FLAT DRIVE	
2	THROUGH HOLE PIN DRIVE		6	DING DRIVE KEYWAY	
3	KEY DRIVE		7	SPLINE DRIVE	
4	SINGLE FLAT DRIVE		8	RIBBED SEGMENT KEY	

- Electronics
- Trolling Motors
- Instruments
- Electrical
- Lighting
- Anchor & Dock
- Safety
- Steering, Controls
- Pumps
- Fuel System
- Seating & Pedestals
- Trailer
- Tops & Covers
- Perform.
- Propellers
- Engine & Care
- Cleaning & Care
- Paint & Paint Acc.
- Fun & Flotation
- Topside Acc.
- Cockpit & Deck
- Hardware, Fasteners
- Camouflage
- Misc.
- Comm.

Jabsco No. to DMI No. Cross Reference

	Jabsco #	DMI #	Description		Jabsco #	DMI #	Description
	11810-0003	417459	UTILITY PUMP 110V 9.5 GPM+C13		18753-0072	421191	VANE SET
	11830-0000	422232	END COVER 3/8		18753-0121	422256	END COVER/CAM SCREW KIT
	11831-0000	418725	END COVER 1		18753-0125	422244	END COVER O-RING 3/8
	11836-0000	422357	END COVER 1/2		18753-0133	422369	END COVER O-RING 1/2
	11860-0005	417778	CLUTCH PUMP 12V 1		18753-0134	422371	END COVER/CAM SCREW KIT
	11870-0005	417802	CLUTCH PUMP 12V 1-1/4		18753-0178	413067	SEALED BEAM 135SL 12/24V
	11876-0000	423777	CLUTCH ADAPTER		18753-0336	413093	SEALED BEAM 255SL 12/24V
	11979-0001-P	418599	IMPELLER		18753-0384	421949	LIP SEAL
	12062-0000	418738	END COVER 1.25-2		18753-0434	425846	END COVER O-RING 18770
	1210-0001-P	418309	IMPELLER PORT 1/2 NEOPR		18753-0455	413081	SEALED BEAM 146SL 12/24V
	1210-0003-P	418311	IMPELLER PORT 1/2 NITRL		18753-0526	425909	BEARING
	12210-0003	417407	UTILITY PUMP 110V 3.4 GPM		18753-0527	425911	ROLLER BEARING
	1414-0003-P	415364	OIL CHANGER IMPELLER		18753-0528	413043	SEALED BEAM 155SL 12/24V
	14750-0001	418233	IMPELLER		18753-0530	425884	SLINGER O-RING
	14750-0003-P	418246	IMPELLER		18753-0616	425644	LIP SEAL LARGE
Electronics	15278-1000	425620	FLAPPER ASSEMBLY VORTEX 15780		18753-0652	421204	REVERSING SWITCH
Trolling Motors	15294-1010	425593	WEAR RING ONLY 15780		18753-0660	421925	END COVER O-RING
	15294-1020	425594	WEAR RING KT VORTEX 15780		18754-1004	425543	O-RING
Instruments	15295-1010	425606	SHAFT VORTEX 15780		18770-0003	424109	ENGINE PUMP CMMNS K19 2 HOLE
	15296-1000	425579	WEAR PLATE VORTEX 15780		18784-1000	425822	END COVER 18770
Electrical	15297-1010	425581	CAM LINER VORTEX 15780		18784-2000	425442	END COVER
	15298-1020	425668	BRONZE IMPELLER KT VORTEX 15780		18785-0000	425858	CAM LINER/O RING 18770
	15299-1000	425618	FLEXIBLE IMPELLER VORTEX 15780		18786-0001-W	418625	IMPELLER KIT
Lighting	15780-0000	424159	ENGINE PUMP CUMMINS VORTEX		18787-0000	425872	WEAR PLATE 18770
Anchor & Dock	1673-1001	417902	ENGINE PUMP 1/2 11.3 GPM		18789-0001	425834	IMPELLER 18770
	17215-0000	415275	DRILL PUMP KIT		18810-0000	414641	PRESSURE TANK
Safety	17250-0003	415287	DRILL PUMP		18838-0001-P	423361	SHERWOOD IMPELLER
	17255-0003-P	415353	DRILL PUMP IMPELLER		18948-0001-P	418664	10615 SHERWOOD IMPELLER
	17360-1001	424058	ENGINE PUMP 2 CAT D336/353		18958-0001-P	418613	IMPELLER
Steering, Controls	17365-1000	425517	END COVER GASKET 18770		2235-0000	421608	WEAR PLATE
	17370-0001-P	425492	IMPELLER 17360		22405-0001-P	418700	IMPELLER KITONANWE
Pumps	17372-1000	425531	WEARPLATE		2574-0000	416594	WEAR PLATE 1.25-2
	17374-1000	425529	CAM LINER 17360		2620-1101	417898	ENGINE PUMP 3/8 5.8 GPM
Fuel System	17378-1000	425505	END COVER		29045-0000	414920	TOILET SERVICE KIT PRE '97
	17800-2000	415326	OIL CHANGER UNIT		29045-2000	414932	TOILET SERVICE KIT '97-'07
Seating & Pedestals	17850-1012	415338	DIY OIL CHANGER		29045-3000	414935	TOILET SERVICE KIT '98-DATE
	17860-2012	415340	OIL CHANGER FLAT TANK		2907-0000	422268	BRASS CAM 3/8
Trailering	17935-0001-P	418424	IMPELLER PORT 1.25 NEOP		29090-5000	414906	COMPACT TOILET MANUAL
	17936-0001-P	418457	IMPELLER PORT 2 NEOPRENE		29120-5000	414918	HOUSEHOLD TOILET MANUAL
Tops & Covers	17937-0001-P	418359	IMPELLER PORT 1 NEOPRENE		30124-0000	416026	SERVICE KIT 36600
	17954-0001-P	418637	47-59362 MERC IMPELLER		30200-0000	416138	MOTOR BILGE/WPS BELT 12V
Perform.	17956-0001-P	418384	IMPELLER (6056-0001)		3085-0001-P	418562	IMPELLER
	18080-0000	415299	DRAIN KIT		30919-0001	415186	IMPELLER (30910-0000) PUMP
Propellers	18220-1127	417040	BALLAST PPY W/REVERSE SWITCH		31295-0092	418084	WPS PARMAX 1.9 12V
	18220-9127	417041	BALLAST PPY W/DEUTSCH		31395-0092	414603	WPS PARMAX 2.9 12V
Engine & Care	18330-0000	417838	CLUTCH PUMP 12V 2		31395-0094	414480	WPS PARMAX 2.9 24V
	18370-0000	417999	ENGINE PUMP 2 83 GPM		31620-0092	414490	WPS PARMAX 4.0 12V
Cleaning & Care	18590-2092	415154	MACERATOR 12V RUN DRY		31620-0094	414492	WPS PARMAX 4.0 24V
	18598-1000	415162	MACERATOR SERVICE KIT		31700-0092	414494	W/D BAITWELL PARMAX 12V
Paint & Paint Acc.	18647-0000	421913	END COVER		31705-0092	414817	BILGE PUMP 12V 4.3GPM
	18660-0121	417217	WATER PUPPY 12V 6.3 GPM		31777-0000	414590	SMOOTH FLOW PUMP CONTROL
Fun & Flotation	18670-0123	417243	WATER PUPPY HD 12V 7.8 GL		3180-0000	425430	SLINGER O-RING
	18670-0943	417205	WATER PUPPY HD 24V 7.8 GL		3181-0000	422511	SLINGER 1 1.25 2
Topside Acc.	18673-0001-P	418500	IMPELLER PORT 3/8 NEOPR		32600-0092	414487	WPS PARMAX 3.5 12V
	18680-1000	417053	DSL TRANSFER PUMP 12V 6 GPM		32600-0094	414488	WPS PARMAX 3.5 24V
Cockpit & Deck	18685-0000	414463	DSL TRANSFER PUMP 110V 7 GPM		32605-0092	414628	WASH/DOWN PARMAX 4.0 KIT
	18690-0000	415174	HD MACERATOR 110V		3286-0000	422408	SLINGER 1/2
Hardware, Fasteners	18711-0000	422624	RETAINING RING SML 1.25		32900-0092	414780	W/D PARMAX 4.0 KIT W/HS
	18712-0000	422612	RETAINING RING LRG 1.25		3298-0000	421583	END COVER GASKET
Camouflage	18713-0000	422547	RETAINING RING SML 1/2		33799-0000	415251	UTILITY HAND PUMP HANDY BOY
	18721-0000	425466	RETAINING RING/SEAL		34060-0010	415249	UTILITY HAND PUMP LIL PAL
Misc.	18724-0000	422535	RETAINING RING LRG 1/2		34060-0130	415237	PUMP-HAND OIL DRAIN
	18725-0000	422802	RETAINING RING LRG 2		34744-0000	413904	BLOWER 115V AC
Comm.	18752-0000	425566	BEARING		35115-0020	413916	BLOWER FLG 3 105 CFM 12V
	18753-0007	425656	BEARING VORTEX 15780		35400-0000	413966	BLOWER FLG 4 250 CFM 12V
					35515-0010	414019	BLOWER FLX 3 105 CFM 12V



Jabsco No. to DMI No. Cross Reference

36200-0000	414350	PUMP GUARD 3/4	6398-0000	423222	SLINGER O-RING BAG/3
36400-0000	414754	PUMP GUARD 1/2	6400-0004	417953	ENGINE PUMP 1.25 62 GPM
36600-0000	414261	BILGE PUMP 12V 8 GPM	6400-1051	417954	ENGINE PUMP 1.25 62 GPM SS
36680-2000	414235	BILGE PUMP 12V 5.5 GPM	64046-0006	413051	SPOT/FLOOD BULB & SEAL
36740-0000	414021	BLOWER FLX 3 150 CFM 12V	6407-0010	423234	WATER SEAL 1.25
36950-2000	414499	WATER PRESSURE SYSTEM 12V	6408-0000	423246	WATER SEAL 2
37010-0092	415085	TOILET CONVERSION KT 12V	6590-0005	417687	CLUTCH PUMP MAN 1-1/4
37010-3092	414956	COMPACT TOILET 12V	6760-0003-P	418465	IMPELLER PORT 2 NITRILE
37010-4092	414970	HOUSEHOLD TOILET 12V	6988-0000	423272	BRASS CAM 2
37040-0000	415011	TOILET SERVICE KIT FOR 37010	7273-0003-P	418536	IMPELLER
37041-0010	415023	REPLACEMENT PUMP ASSY 12V	7420-0004	417964	ENGINE PUMP 1.25 62 GPM
37064-0000	415035	REPLACEMENT MOTOR 12V	777-9001	417940	ENGINE PUMP 1 26 GPM
37121-0010	425721	PRESSURE SWITCH	7867-0000	425404	BRASS CAM PUMP
4156-0000	422484	WEAR PLATE 1	7868-0000	423690	WEAR PLATE
4156-0010	423121	WEAR PLATE 6050	7869-0000	423309	CAM/PLATE ASSEMBLY
42630-2992-P	417251	WPS PARMAX 1.0 12V	816-0000	418888	END COVER GASKET 1.25-2
42630-3992-P	417252	WPS PARMAX 1.0 12V KT	817-0000	423335	INNER BEARING LIP SEAL 1.25
42631-2900	417255	PARMAX 112V	818-0000	423347	OUT BEARING LIP SEAL 1.25/2
42755-0092	414701	WPS V-FLO 5.0 12V	82500-0092	418080	WPS PARMAX PLUS 5.0 12V
43670-0003	412471	CONTROL 146/255SL 12/24V	82505-0092	414629	W/D PARMAX+ 5.0 12V KIT
43670-0004	412508	DUAL CNTRL 146/255SL 12V	82600-0092	418082	WPS PARMAX PLUS 6.0 12V
436977	417244	PUMP CENTRFLG MAG 11GPM	82600-0094	418083	WPS PARMAX PLUS 6.0 24V
436979	417246	PUMP CENTRFLG MAG 14GPM	82605-0092	414630	W/D PARMAX+ 6.0 12V KIT
436981	417248	PUMP CENTRFLG MAG 21GPM	834-0001	423373	BRASS CAM 1.25
43990-0013	412522	WIRE HARNESS SL LITE 10'	836-0001-P	418435	IMPELLER PORT 1.25 NEOP
43990-0015	412546	WIRE HARNESS SL LITE 25'	836-0003-P	418448	IMPELLER PORT 1.25 NITR
44411-0045	414716	INLINE WTR PRESSURE RGLTR 3/4	890-0000	418878	END COVER GASKET 1
44412-1045	414704	FLUSH WATER PRESSURE RGLTR 1/2	90058-0003	423688	SERVICE KIT 6050
4528-0001-P	418497	IMPELLER	90202-0000	425825	SERVICE KIT VORTEX 15780
45490-1000	415201	Y VALVE	91002-0020	421595	END COVER/CAM SCREW
45900-0000	413500	FLOODLIGHT 4X6 12V/72656	91003-0010	423397	END COVER SCREW 1 3PK
45900-1000	413512	FLOODLIGHT 3X5 12V/73620	91003-0020	425416	CAM SCREW FOR 7867
490-0001	422383	BRASS CAM	91004-0090	421937	END COVER SCREW
50070-0040	418219	IMPELLER PULLER 2-9/16-	91004-0090	422460	CAM SCREW 1
50070-0200	418221	IMPELLER PULLER 2-9/16+	91005-0040	423412	EC/CAM SCREW 1.25-2 3PK
50840-0012	417027	CNTRF PUMP LOW PRESSURE 12V	913-0000	423424	INNER BEARING SEAL/1
50860-0012	417015	CNTRF PUMP HI PRESSURE 12V	920-0001-P	418361	IMPELLER PORT 1 NEOPRNE
50890-1000	415136	PUMP WASTE EVACUATION	920-0003-P	418373	IMPELLER PORT 1 NITRILE
50900-1000	414831	PUMP FISH BOX EVACUATION	9200-0023-P	418601	IMPELLER OIL CHANGER 17800
51270-9013	417697	CLUTCH PUMP MAN 2	9214-0001	422650	SHAFT KEY 1.25
58020-1012	414982	DLX SLANT/BK TOILET 12V	9215-0010	422559	SHAFT KEY 1
58500-0012	414985	LT FLUSH TOILET 12VFT/SW	92300-0030	423664	CLUTCH ASSEMBLY 12V
58500-1012	414988	LT FLUSH TOILET 12VPANEL	92600-0040	422600	BEARING
5929-0003-P	418347	IMPELLER 11810	92600-0060	422523	BEARING
60010-2012	412647	RC SEARCHLIGHT 12V 255SL	92600-0260	422787	BEARING 2
60020-0000	412609	RC SEARCHLIGHT 12V 135SL	92600-0540	423703	BEARING
60030-0000	412457	CONTROL 135/155SL 12/24V	92700-0050	422270	WATER LIP SEAL 3/8
60080-0012	412623	RC SEARCHLIGHT 12V 146SL	92700-0060	423498	1 LIP SEAL
6050-0003	417507	UTILITY PUMP 110V 26GPM	92700-0080	423501	LIP SEAL 6050
6050-0013	417509	PUMP ENCLOSED MOTOR 110V	92700-0420	423513	LIP SEAL 11810
6056-0003-P	418412	IMPELLER 6050 PUMP NITRL	92701-0180	422775	INNER BEARING LIP SEAL 2
6065-0003	417511	PUMP HEAD	934-0000	423537	BRASS CAM 1
61050-0012	412611	RC SEARCHLIGHT 12V 155SL	96080-0080	423549	MECHANICAL SEAL 1/2 1
6303-0001-P	418284	IMPELLER	96080-0371	425555	WATER SEAL CAT/CUMMINS
6303-0003-P	418295	IMPELLER	98022-0500	423640	FIELD COIL 12V
6303-0007-P	418285	IMPELLER KIT POS	99202-1000	425682	SERVICE KIT VORTEX 15780
6342-0000	421951	SLINGER	X3001-180F	425860	END COVER SCREWS 18770

Jabsco Replacement Parts for (18780) Pump



Order No.	Mfg. No. / Description	List Price
418625	(18786-0001-W) Impeller Kit	\$196.39 G0-8513100
425442	(18784-2000) End Cover	\$525.19 G0-8815300
425466	(18721-0000) Retaining Ring, Seal	\$23.69 F0-8561000

Jabsco Replacement Part



Order No.	Mfg. No. / Description	List Price
423309	(7869-0000) Cam/Wearplate Assembly	\$51.99 G0-3843000



- Electronics
- Trolling Motors
- Instruments
- Electrical
- Lighting
- Anchor & Dock
- Safety
- Steering, Controls
- Pumps**
- Fuel System
- Seating & Pedestals
- Trailering
- Tops & Covers
- Perform.
- Propellers
- Engine & Care
- Cleaning & Care
- Paint & Paint Acc.
- Fun & Flotation
- Topside Acc.
- Cockpit & Deck
- Hardware, Fasteners
- Camouflage
- Misc.
- Comm.

Johnson Pedestal Style Engine Cooling Pump

SPXFLOW
Johnson Pump



- For Onan, Westerbeke.
- Port Size: 3/8" NPT.
- Mounting type: Pedestal.
- Mechanical seal.
- Impeller: 09-808B-1. Service Kit: 09-46840.

Order No.	Mfg. No. / Description	List Price
461944	(10-24569-09) F35B-8027	\$314.79
462262	(09-808B-1) Impeller	\$29.89

Johnson Crankshaft Style Engine Cooling Pump

SPXFLOW
Johnson Pump



- Featured on Indmar, Marine Power, Volvo, PCM engines.
- 15% more flow.
- Bronze body, stainless steel shaft, flexible impeller, flange mounted, vertical ports, OEM pumps.
- Impeller: 09-812B-1.

Order No.	Mfg. No. / Description	List Price
461401	(10-24946-01) F6B-9	\$274.99
462250	(09-812B-1) Impeller	\$46.69
462907	(09-45825) Service Kit	\$80.69

Johnson Crankshaft Style Engine Cooling Pump

SPXFLOW
Johnson Pump



- Featured on older style small block GM marine engines.
- Bronze body, stainless steel shaft, flexible impeller, flange mounted, vertical ports, OEM pumps.
- Impeller: 09-1027B-10.

Order No.	Mfg. No. / Description	List Price
461385	(10-24228-1) F5B-9	\$312.59
462248	(09-1027B-1) Impeller	\$36.29

Johnson Electro-Magnetic Clutch Pump

SPXFLOW
Johnson Pump



- 12 volt 2x4 7" Pulley with bronze body.
- Ports: 1-1/4" NPT.
- Mechanical seal.
- Impeller: 09-819B. Service Kit: 09-45575.
- Cross to Jabsco 11870-0005.

Order No.	Mfg. No. / Description	List Price
461777	(10-1302295-1) F8B-50017	\$936.49
462310	(09-819B-00) Impeller	\$73.89

Johnson Electro-Magnetic Clutch Assembly

SPXFLOW
Johnson Pump



- 2x4 7" pulley.
- Fits: F7B-5, F8B-5 and F9B-5 Clutch Pumps.
- 12 volt.

Order No.	Mfg. No. / Description	List Price
462995	(0.3454.001)	\$262.39

Johnson Pump Impeller Replacement Kit

SPXFLOW
Johnson Pump

- Replaces: Johnson 09-824P-1; Jabsco 6303-0007-P (Green).
- Fits: Johnson 12V (10-24690-03) Ballast Pump, 24V (10-24690-04) Ballast Pump and Jabsco 12V (18220-1127).
- FX reverse design - run dry capable.

Order No.	Mfg. No. / Description	List Price
470178	(09-824P-1EZ)	\$40.39

Johnson Pump Impellers

SPXFLOW
Johnson Pump



Order No.	Mfg. No.	Fit Pump	Material	List Price
462299	(09-806B-1)	F35	MC97	\$32.89
462262	(009-808B-1)	F35	MC97	\$29.89
462300	(09-810B-1)	F4	MC97	\$27.49
462302	(09-810B-9)	F4	Nitrile	\$32.79
462250	(09-812B-1)	F6	MC97	\$46.69
462301	(09-814B)	F9	Neoprene	\$119.19
462310	(09-819B-00)	F8	Neoprene	\$73.89
462312	(09-819B-9)	F8	Nitrile	\$97.89
462313	(09-820B)	F95	Neoprene	\$316.99
7000662	(09-821BT-1)	F75	MC97	\$102.59
470178	(09-824P-1EZ)	F4	Polyurethane	\$40.39
461982	(09-824P-2)	F4		\$40.39
462286	(09-824P-9)	F4	Nitrile	\$35.99
461987	(09-849P-2)			\$51.49
462274	(09-1026B-1)	F4	MC97	\$30.39
462322	(09-1026B-9)	F4	Nitrile	\$56.19
462248	(09-1027B-1)	F5	MC97	\$36.29
462034	(09-1028BT-1)	F7	MC97	\$42.19
462326	(09-1052S-9)	TA3P10	Nitrile	\$25.39
462328	(09-1077B-9)	F2	Nitrile	\$37.99
462005	(09-701B-1)		MC97	\$34.29

Johnson Pump 30 GPM Ballast Pump

SPXFLOW
Johnson Pump



- Built in thermal overload protection: Automatic reset after cooling down.
- Monitor filling: Tanks must have overflow protection.
- Retrofit possible: Important to have full bore hoses - without restriction.
- Dry run impeller.
- Intermittent duty.
- Recommend fresh batteries and engine running (alternator running) to ensure power supply.

Order No.	Mfg. No. / Description	List Price
461985	(10-24939-18) Pump	\$426.49 G0-5758200
461987	(09-849P-2) Impeller	\$51.49 G0-0543000

Johnson Pump DC Driven Flexible Impeller Pump

SPXFLOW
Johnson Pump



- Perfect for bilge pumping, deckwash, water circulation, oil & diesel refueling at dockside service, etc.
- 12.5 GPM.
- Connection: Hose 1" and 1/2" NPT.
- Impeller: 09-824P-9 (Nitrile).
- 12 volt.

Order No.	Mfg. No. / Description	List Price
461866	(10-24689-03) F4B-19	\$339.99 G0-9772200
462286	(09-824P-9) Impeller	\$35.99 G0-1142000

Johnson Pump DC Driven Flexible Impeller Pump

Johnson Pump 13.5 GPM Ballast Pump

SPXFLOW
Johnson Pump



- High capacity 13.5 GPM.
- Self-priming. Reversible.
- Ball bearing design with bronze head.
- Thermal overload (run dry) motor protection.
- Intermittent duty.
- Versatile high volume connection options.
- 12 volt.

Order No.	Mfg. No. / Description	List Price
461980	(10-24690-18) Pump	\$319.89 G0-3341200
461982	(09-824P-2) Impeller	\$40.39 G0-6072000

Johnson Pump DC Driven Flexible Impeller Pump

SPXFLOW
Johnson Pump



- Perfect for bilge pumping, deckwash, water circulation, oil & diesel refueling at dockside service, etc.
- 9 GPM.
- Connection: Hose 1" and 1/2" NPT.
- Can be combined with a vacuum switch for automatic operation.
- Impeller: 09-824P-9 (Nitrile).
- 12 volt.

Order No.	Mfg. No. / Description	List Price
461962	(10-24727-03) F38B-19	\$246.99 G0-8456100
462286	(09-824P-9) Impeller	\$35.99 G0-1142000

- Perfect for bilge pumping, deckwash, water circulation, oil & diesel refueling at dockside service, etc.
- 5.5 GPM.
- Connection 3/8" NPT.
- Can be combined with a vacuum switch for automatic operation.
- Impeller: 09-843S -9 (Nitrile).
- 12 volt.

Order No.	Mfg. No. / Description	List Price
461961	(10-24516-03) F3B-19	\$237.39 G0-5095100

SPXFLOW
Johnson Pump



- Electronics
- Trolling Motors
- Instruments
- Electrical
- Lighting
- Anchor & Dock
- Safety
- Steering, Controls
- Pumps**
- Fuel System
- Seating & Pedestals
- Trailering
- Tops & Covers
- Perform.
- Propellers
- Engine & Care
- Cleaning & Care
- Paint & Paint Acc.
- Fun & Flotation
- Topside Acc.
- Cockpit & Deck
- Hardware, Fasteners
- Camouflage
- Misc.
- Comm.

Johnson Pump Application Guide

SPXFLOW

Johnson Pump®

Electronics

Trolling Motors

Instruments

Electrical

Lighting

Anchor & Dock

Safety

Steering, Controls

Pumps

Fuel System

Seating & Pedestals

Trailering

Tops & Covers

Perform.

Propellers

Engine & Care

Cleaning & Care

Paint & Paint Acc.

Fun & Flotation

Topside Acc.

Cockpit & Deck

Hardware, Fasteners

Camouflage

Misc.

Comm.

Johnson Pump Model Number	Engine Application where Applicable	Port Size	Mounting Type	Service Kit	Impeller	End Cover	Wearplate	Cam
F5B-9 461385 10-24228-1 (10950-240)	Volvo - 431A, 500A/B, 501A, 570A, 571A, AQ180 AQ200, AQ200B/C/D/F, AQ205A, AQ211A AQ225, AQ231A/B, AQ260, AQ255B, AQ260A, AQ271A/B/C/D, AQ280A, AQ290A	3/4"	Flange	09-45808	462248 09-1027B (1210-0001)	01-45312-1	–	05-04-174
F35B-9 10-35-157-3 (29300-2101c)	Volvo - MB10A/11, MD1, MD11C/D, MD1A/1B, MD1KHD/HY, MD2, MD2B, MDHBY, MD5B/C, MD6A, MD7A/B	3/8"	Flange	09-45589	4610029 09-808B	01-43239 (29305-0000)	01-45087 (29306-0000)	01-42679 (ALB)
F7B-9 10-24277-3	Volvo - AD31A/B, AD41A/B, AQAD31A, AQD40A, AQD41A, D41A/B, MD31, MD31A, MD40A, TAMD31, TAMD31A, TAMD41, TAMD41A/B, TMD31, TMD31A/B, TMD40A/B/C, TMD41A/B	1"	Flange	09-45592	462034 09-1028B (17937-0001)	01-42441 (3993)	–	01-42679 (934)
F4B-9 10-35098-3	Volvo - AQ110/115, AQ115A/B, AQ120, AQ120B, AQ125A/B, AQ130, AQ130A/B/C/D, AQ140, AQ60F, BB100, BB115A/B, BB30, MB16A, MB18, MB18F, MB20A/B/C, MD17C/D, MD20B, MD3B	3/8"	Flange	09-45905	462322 09-1026B (18673-0001)	01-45282 (29475-0000)	–	01-42389 (10818)
F6B-9 461401 10-24930-01 (22740-0000)	Indmar - Marine Power	3/4"	Flange	462907 09-45825	462250 09-812B (13554-0001)	01-45312-1	–	01-45670
F9B-9 10-13096-2	Detroit Diesel - 653, 671, 853	1-1/2" Flanged	Flange	09-45579	462312 09-819B	01-42422-1 (9336)	01-42423 (2574)	01-42680 (834)
F9B-9 10-13095-02	Detroit Diesel - 671T, 871, 1271	2" Flanged	Flange	0945582	09-814B (17936-0001)	01-42422-1 (9336)	01-42423 (2574)	01-43137 (6988)
F9B-9 10-24239-2 (22040-0501)	Man - D2540MLE, D2840LXE/LE401, D2849LE403, D2842LE, D2842LE401/02/06/03/08, D2842LYE/LZE, D2848LE/LXE/LE401/403	2" Flanged	Flange	09-45581	09-802B (17936-0001)	01-42422-1 (9336)	01-42423 (2574)	01-43137 (6988)
F5B-9 10-24140-5	Amercian Diesel 4 Cyl., Ford Lehman Pump	3/4" NPT	Flange	09-45583	462248 09-1027B-1 (1210-0001)	01-42398 (3992)	01-42399 (7883)	01-42397 (490)
F7B-9 10-24139-5	American Diesel 6, Ford Lehman Pump	1" NPT	Flange	09-45590	462034 09-1028BT-1 (17937-0001)	01-42441 (3993)	01-42443 (4156)	01-42679 (934)
F35B-8007 10-35038-4 (2620-1001)	Appollo Diesel, Next Generation (3/8" Shaft)	3/8" NPT	Pedestal	09-45589	09-808B	01-43239 (29305-0000)	01-45087 (29306-0000)	01-42415 (29303-0000) (AL8-01)
F35B-8027 10-35038-5	Onan, Westerbeke (12mm) Metric Shaft	3/8" NPT	Pedestal	09-45589	09-808B	01-43239 (29305-0000)	01-45087 (29306-0000)	01-42415 (29303-0000) (AL8-01)
F4B-1907 10-24512-3	Multi purpose impeller pump	1/2" NPT 1' Hose	Pedestal	09-46600	09-824P-9	01-42398 (3992)	–	–
F8B-8007 10-13021-95 (6400-0004)	Multi purpose impeller pump	1-1/4" NPT	Pedestal	09-45575	462312 09-819B	01-42422-1 (9336)	01-42423 (2574)	01-42680 (834)
F7B-8007 461513 10-24070-51	Multi purpose impeller pump (Replaces Jabsco Model 777-9001)	1" NPT	Pedestal	09-45592	462034 09-1028B (17937-0001)	01-42441 (3993)	–	01-42679 (934)
F7B-5 10-24071-17 (11860-0005)	Electric Clutch Pump - 12V, 2A Pulley	1" NPT	Pedestal	09-45592	462034 09-1028B (17937-0001)	01-42441 (3993)	–	01-42679 (934)
F8B-50017 461777 10-13022-95 (50200-2011)	Electric Clutch Pump - 12V, 2xA 7" Pulley (Replaces Jabsco Model 11870-0005)	1-1/4" NPT	Pedestal	09-45575	462310 09-819B	01-42422-1 (9336)	01-42423 (2574)	01-42680 (834)

Sherwood Cooling Pump



- Inlet port: 1-1/2".
- For B Series 250 HP, 3912962.

Order No.	Mfg. No. / Description	List Price	
749300	(GC1-01) Pump	\$912.19	G0-7111600
749210	(23980-SHW) Minor Repair Kit	\$108.09	G0-2427000
749250	(23981-SHW) Major Repair Kit	\$257.49	G0-2527100
749050	(15000K-SHW) Impeller Kit	\$57.29	G0-8383000

Sherwood Cooling Pump



- Inlet port: Without ports.
- For Caterpillar 3116.

Order No.	Mfg. No. / Description	List Price	
749320	(P1710C) Pump	\$953.69	G0-7983600
749220	(25123-SHW) Minor Repair Kit	\$408.19	G0-9437200
749260	(25121-SHW) Major Repair Kit	\$554.89	G0-8717300
749060	(17000K-SHW) Impeller Kit	\$67.59	G0-9254000

Sherwood Cooling Pumps



- Inlet port: 2".
- For 6 cylinder diesel.

Order No.	Mfg. No. / Description	List Price	
749330	(P1716C) B & C Series 300 HP, 3919899, 3922590	\$1,111.89	G0-7944700
749340	(P1722C) C Series 3912139, 3922589	\$1,111.89	G0-7944700
749350	(P1727C) B & C Series 3897194	\$879.39	G0-9198500
749100	(P1730C) C Series 3866493	\$777.09	G0-5602500
749230	(25124-SHW) Minor Repair Kit	\$374.19	G0-1705200
749270	(25122-SHW) Major Repair Kit	\$515.79	G0-8554300
749060	(17000K-SHW) Impeller Kit	\$67.59	G0-9254000

Sherwood Cooling Pump



- Inlet port: 1-1/4".
- For 4 Cylinder Diesel B Series, 3907458, 3912019.

Order No.	Mfg. No. / Description	List Price	
749310	(M71) Pump	\$551.39	G0-3496300
749200	(23976-SHW) Minor Repair Kit	\$100.79	G0-3576000
749240	(23977-SHW) Major Repair Kit	\$236.19	G0-5285100
749040	(10615K-SHW) Impeller Kit	\$33.79	G0-4622000

Sherwood Cooling Pump



- Inlet port: Without ports.
- For Caterpillar 3126.

Order No.	Mfg. No. / Description	List Price	
749360	(P1732C) Caterpillar 3126	\$878.99	G0-2988500
749220	(25123-SHW) Minor Repair Kit	\$408.19	G0-9437200
749260	(25121-SHW) Major Repair Kit	\$554.89	G0-8717300
749060	(17000K-SHW) Impeller Kit	\$67.59	G0-9254000

Sherwood Impeller Kits



Order No.	Mfg. No. / Description	List Price	
749000	(08000K-SHW) For G8002, G8005	\$31.69	G0-3212000
749010	(09000K-SHW) For G11, G907P, G910P	\$37.69	G0-5252000
749020	(09959K-SHW) For G1, G2, G20, G21, G65, G9903	\$29.59	G0-3891000
749030	(10077K-SHW) For G702, R30G-1, R30G	\$37.19	G0-2942000
749050	(15000K-SHW) For G1505, G1508, G151, GC5, GC1	\$57.29	G0-8383000
749060	(17000K-SHW) For P1710C, P1716C, P1722C, P1719X, P1727C, P1730C, P1733X, P176X	\$67.59	G0-9254000
749070	(18000K-SHW) For Caterpillar 1230492, 1095324, 1095327, 1239785, Cummins 4019403, 4933743	\$209.19	G0-6104100
749080	(26000K-SHW) For G2603X Pump	\$191.09	G0-3082100
749090	(27000K-SHW) For P2708X Pump	\$97.89	G0-9556000

Sherwood Impeller Puller



Order No.	Mfg. No. / Description	List Price	
749110	(25105-SHW) 3/4" - 16	\$15.89	G0-5601000

- Electronics
- Trolling Motors
- Instruments
- Electrical
- Lighting
- Anchor & Dock
- Safety
- Steering, Controls
- Pumps
- Fuel System
- Seating & Pedestals
- Trailer
- Tops & Covers
- Perform.
- Propellers
- Engine & Care
- Cleaning & Care
- Paint & Paint Acc.
- Fun & Flotation
- Topside Acc.
- Cockpit & Deck
- Hardware, Fasteners
- Camouflage
- Misc.
- Comm.

Jabco Cyclone™ Stainless Steel Centrifugal Pumps



417027

- Heavy duty robust stainless steel construction.
- One tool servicing (3/8" spanner).
- Virtually silent running centrifugal pump.
- Long-life DC motor.
- Rotatable head 90° segments.
- Anti-clog impeller design.
- Long-life mechanical seal.
- 2m suction lift when wet.
- Port fitting: 3/4" NPT.
- 12 volt.



417015

CYCLONE LOW PRESSURE PUMP

- Maximum flow rate: 29.7 GPM.
- Pressure up to 8.7 PSI.
- Continuously rated.
- Motor life: 3,500 hours.

Order No. Mfg. No. / Description
417027 (50840-0012)

List Price
\$432.49 GO-7798200

CYCLONE HIGH PRESSURE PUMP

- Maximum flow rate: 29.7 GPM.
- Pressure up to 17.4 PSI.
- Recommended duty - max. 30 minutes on, min. 30 minutes off.
- Motor life: 2,500 hours.

Order No. Mfg. No. / Description
417015 (50860-0012)

List Price
\$465.99 GO-1221300

Jabco Water Puppy - Flexible Impeller Pump



- For general transfer pumping where self-priming are required.
- Maximum flow rate: 6.3 GPM.
- Self-priming from dry up to 4'.
- Ports: 1/2" internal pipe threads and 1" external hose barb adapter for 3/4" external garden hose thread included.
- 12 volt.

Order No. Mfg. No. / Description List Price
417217 (18660-0121) **\$226.39** GO-8615100

REPLACEMENT PARTS

Order No.	Mfg. No. / Description	List Price	
418284	(6303-0001-P) Impeller - Neoprene	\$30.29	GO-9202000
421913	(18647-0000) End Cover	\$30.19	GO-3202000
421925	(18753-0660) End Cover O-ring	\$7.69	GO-5150000
421937	(91004-0090) End Cover Screw	\$9.49	GO-6360000
421949	(18753-0384) Lip Seal	\$38.89	GO-6062000
421951	(6342-0000) Slinger	\$5.29	GO-4530000

Jabco Reversible Rotary Vane Pump



- Ideal for transferring diesel fuel.
- With its integral on/off reversing switch, it is ideal for moving fuel between port and starboard fuel tanks.
- Maximum flow rate: 6 GPM.
- Self-priming from dry up to 3'.
- Ports: 1/2" NPT female or 1" hose barb.
- 12 volt.

Order No. Mfg. No. / Description List Price
417053 (18680-1000) **\$458.59** GO-6270300

REPLACEMENT PARTS

Order No.	Mfg. No. / Description	List Price	
421913	(18647-0000) End Cover	\$30.19	GO-3202000
421925	(18753-0660) End Cover O-ring	\$7.69	GO-5150000
421937	(91004-0090) End Cover Screw	\$9.49	GO-6360000
421191	(18753-0072) Vane Set	\$25.99	GO-1471000
421949	(18753-0384) Lip Seal	\$38.89	GO-6062000
421951	(6342-0000) Slinger	\$5.29	GO-4530000
421204	(18753-0652) Reversing Switch	\$74.09	GO-4694000

Jabco Commercial Duty Water Puppy - Flexible Impeller Pump



- For general transfer pumping where self-priming are required.
- Maximum flow rate: 8 GPM.
- Self-priming from dry up to 4'.
- Ports: 1/2" internal pipe threads and 1" external hose barb adapter for 3/4" external garden hose thread included.

Order No. Mfg. No. / Description List Price
417243 (18670-0123) 12 volt **\$395.99** GO-1356200
417205 (18670-0943) 24 volt **\$395.99** GO-1356200

REPLACEMENT PARTS

Order No.	Mfg. No. / Description	List Price	
418295	(6303-0003-P) Impeller - Nitrile	\$29.49	GO-6791000
421913	(18647-0000) End Cover	\$30.19	GO-3202000
421925	(18753-0660) End Cover O-ring	\$7.69	GO-5150000
421937	(91004-0090) End Cover Screw	\$9.49	GO-6360000
421949	(18753-0384) Lip Seal	\$38.89	GO-6062000
421951	(6342-0000) Slinger	\$5.29	GO-4530000

Jabco 115V AC Vane Pump



- Ideal for pumping light oil or transferring diesel fuel.
- Rated for continuous duty.
- Maximum flow rate: 7.9 GPM.
- Self-priming from dry up to 4.9'.
- Protection: Thermal overload.
- Ports: 1/2" NPT female or 1" hose barb.
- 115V AC.

Order No. Mfg. No. / Description List Price
414463 (18685-0000) **\$734.69** GO-4229400

REPLACEMENT PARTS

Order No.	Mfg. No. / Description	List Price	
421913	(18647-0000) End Cover	\$30.19	GO-3202000
421925	(18753-0660) End Cover O-ring	\$7.69	GO-5150000
421937	(91004-0090) End Cover Screw	\$9.49	GO-6360000
421191	(18753-0072) Vane Set	\$25.99	GO-1471000
421949	(18753-0384) Lip Seal	\$38.89	GO-6062000
421951	(6342-0000) Slinger	\$5.29	GO-4530000
421204	(18753-0652) Reversing Switch	\$74.09	GO-4694000

Johnson Pump Reversible Impeller Oil Change Pump

SPXFLOW
Johnson Pump



- Reversible rubber impeller pump with integrated quick reversing switch.
- Designed to remove old oil from the engine/fill new oil back into the engine.
- 5.5 GPM.
- Connection 3/8" NPT.
- Lip seal.
- Impeller: 09-843S-9. Service Kit: 09-47406.
- 12 volt.

Order No.	Mfg. No. / Description	List Price
462000	(10-24760-03) F3B-19	\$287.89 GO-9829100

Johnson Pump Gear Pump with Oil Change Kit

SPXFLOW
Johnson Pump



- Can run dry!
- Self priming: Up to 3.28 feet.
- Capacity 2.11 GPM
- Light and compact oil change pump with pump body & gears made of PTFE.
- Complete with oil dip stick extraction tube .236" and .315", 70.9" connection wires with battery clamps.

Order No.	Mfg. No. / Description	List Price
470090	(80-47508-01) 12 volt	\$156.89 GO-2150100

Groco GP Series Gear Pumps

GROCO.



- Self-priming, instantly reversible and are capable of operation in either direction.
- Relatively low flow (less than vane pumps) makes them suitable for duties such as deck-wash, fuel transfer, ballast transfer and oil change.
- All models have an ignition protected motor and #316 stainless steel shaft, and are available in models that provide reversing (R), remote reversing (RR), and reversing with touchpad (RT) control options.
- 3 GPM.
- 3/8" NPT.
- Note: Do not pump gasoline or other explosive liquids.

Order No.	Mfg. No.	Control Type Included:	
S/O	(GPB-1)	None	POR
S/O	(GPBR-1)	Pump Mounted Reversing Switch	POR
S/O	(GPRR-1)	Remote Momentary Reversing Rocker Switch	POR

Groco SPO Series Vane Pumps

GROCO.



- Self-priming, instantly reversible and are capable of operation in either direction.
- Their relatively high flow makes them suitable for general purpose duties such as deck wash, bilge pumping, fuel transfer, ballast transfer and oil change.
- Ignition protected motor, #316 stainless steel shaft.
- 6.5 GPM.
- 1/2" NPT + garden hose adapter.
- 12 volt.
- Note: Do not pump gasoline or other explosive liquids.

Order No.	Mfg. No.	Control Type Included:	List Price
375181	(SPO-60-N 12V)	None	\$414.09 GO-4477200
375177	(SPO-60-R 12V)	Pump Mounted Reversing Switch	\$591.59 GO-7369300

Groco G-3 U-Lube Oil Change System

GROCO.



- A powerful gear pump that delivers an honest 3-plus GPM.
- All models have dry-run protection, touchpad control, a plumbing schematic to tell you what hose goes where and a handy maintenance log.
- Self-priming.
- Covered (except for the valves), for a clean engine room appearance, and offers a compact mount footprint.
- Touch-pad control and over-current protection are cover-mounted.
- Manifold connection: 1/2" NPT.
- Pump connection: 1/2" hose barb.
- # of valves: 3.
- 3 GPM.

Order No.	Mfg. No. / Description	Price on Request
S/O	(G-3)	Price on Request

Groco G-6 U-Lube Oil Change System

GROCO.



- A powerful gear pump that delivers an honest 3-plus GPM.
- All models have dry-run protection, touchpad control, a plumbing schematic to tell you what hose goes where and a handy maintenance log.
- Self-priming.
- Covered (except for the valves), for a clean engine room appearance, and offers a compact mount footprint.
- Touch-pad control and over-current protection are cover-mounted.
- Manifold connection: 1/2" NPT.
- Pump connection: 1/2" hose barb.
- 3 GPM.

Order No.	Mfg. No. / Description	Price on Request
S/O	(G-4) # of Valves: 4	Price on Request
S/O	(G-5) # of Valves: 5	Price on Request
S/O	(G-6) # of Valves: 6	Price on Request

- Electronics
- Trolling Motors
- Instruments
- Electrical
- Lighting
- Anchor & Dock
- Safety
- Steering, Controls
- Pumps
- Fuel System
- Seating & Pedestals
- Trailering
- Tops & Covers
- Perform.
- Propellers
- Engine & Care
- Cleaning & Care
- Paint & Paint Acc.
- Fun & Flotation
- Topside Acc.
- Cockpit & Deck
- Hardware, Fasteners
- Camouflage
- Misc.
- Comm.

Jabco Bronze AC Motor Pump Unit



- Bronze pump head.
- Maximum flow rate: 3.4 GPM.
- Maximum head: 40'.
- Self-priming from dry up to 4.9'.
- Ports: 3/8" IPT and adaptors for 3/4" GHT.
- Intermittent duty cycle.
- 115V AC.

Order No.	Mfg. No. / Description	List Price	
417407	(12210-0003)	\$621.69	GO-3561400

REPLACEMENT PARTS

Order No.	Mfg. No. / Description	List Price	
415364	(1414-0003-P) Impeller - Nitrile	\$33.49	GO-4422000
421951	(6342-0000) Slinger	\$5.29	GO-4530000

Jabco Bronze AC Motor Pump Unit



- Bronze pump head.
- Maximum flow rate: 23 GPM.
- Maximum head: 60'.
- Self-priming from dry up to 7.8'.
- Ports: 1" NPT, internal.
- Continuous duty.
- 115/230V AC.

Order No.	Mfg. No. / Description	List Price	
417507	(6050-0003) Open Drip Proof Motor	\$1,101.19	GO-0873700
417509	(6050-0013) Totally Enclosed Fan Cooled Motor	\$1,434.09	GO-4806900

REPLACEMENT PARTS

Order No.	Mfg. No. / Description	List Price	
418412	(6056-0003-P) Impeller - Nitrile	\$188.89	HO-3331100
423688	(90058-0003) Service Kit	\$193.89	GO-1992100
418725	(11831-0000) End Cover	\$28.49	GO-9091000
418878	(890-0000) End Cover O-ring	\$4.19	GO-1820000
423397	(91003-0010) End Cover / Cam Screw Kit	\$17.59	GO-9711000
423537	(934-0000) Brass Cam	\$37.39	FO-7162000
422460	(91004-0090) Cam Screw	\$9.49	GO-6360000
423121	(4156-0010) Wear Plate	\$28.19	GO-9881000
423501	(92700-0080) Lip Seal	\$69.09	GO-9264000
423222	(6398-0000) Slinger O-ring, Bag of 3	\$31.39	GO-3012000

Rule General Purpose Pump



- It is designed for use as a washdown pump and/or to circulate water to your livewell tank.
- Heavy duty construction for use on commercial or pleasure boats.
- 1-1/2" inlet and 1-1/2" discharge outlet.
- Must be mounted below the waterline.
- It does not deliver high pressure, nor is it self-priming.

Order No.	Mfg. No. / Description	List Price	
582611	(17A) 3,800 GPH 12 volt	\$298.79	GO-9100200
582622	(18A) 3,700 GPH 24 volt	\$327.59	GO-9491200

Jabco Bronze AC Motor Pump Unit



- Bronze pump head.
- Maximum flow rate: 9.6 GPM.
- Maximum head: 40'.
- Self-priming from dry up to 7.8'.
- Ports: 1/2" IPT and adaptors for 3/4" GHT.
- Continuous duty.
- 115V AC.

Order No.	Mfg. No. / Description	List Price	
417459	(11810-0003)	\$958.29	GO-5024600

REPLACEMENT PARTS

Order No.	Mfg. No. / Description	List Price	
418347	(5929-0003-P) Impeller - Nitrile	\$106.59	GO-2417000
422232	(11830-0000) End Cover	\$18.89	GO-6621000
421583	(3298-0000) End Cover Gasket	\$9.89	GO-3660000
421595	(91002-0020) End Cover/Cam Screw	\$15.39	GO-1301000
422383	(490-0001) Brass Cam	\$42.89	GO-4782000
423397	(91003-0010) End Cover / Cam Screw Kit	\$17.59	GO-9711000
421608	(2235-0000) Wear Plate	\$14.69	GO-4890000
423513	(92700-0420) Lip Seal	\$31.79	GO-0312000

Jabco Ballast Puppy Bronze DC Pump



- Self-priming and non-airlocking.
- Maximum flow rate: 9 GPM.
- Self-priming from dry up to 3'.
- Ports: 1/2" internal pipe threads, 1" external hose barb.
- Ballast Puppy adds approximately 80 lbs. of ballast per minute.
- Reversible to both fill and empty tanks.
- Available with or without Reversing Polarity Switch to fill or empty ballast tanks.

Order No.	Mfg. No. / Description	List Price	
417040	(18220-1127) Reversing Switch Included	\$398.99	GO-2376200
417041	(18220-9127) No Reversing Switch - Deutsch Conn.	\$348.29	GO-5333200

REPLACEMENT PARTS

Order No.	Mfg. No. / Description	List Price	
418285	(6303-0007-P) Impeller - Green Polyurethane	\$49.79	GO-6333000
421913	(18647-0000) End Cover	\$30.19	GO-3202000
421925	(18753-0660) End Cover O-ring	\$7.69	GO-5150000
421937	(91004-0090) End Cover Screw	\$9.49	GO-6360000
421949	(18753-0384) Lip Seal	\$38.89	GO-6062000
421951	(6342-0000) Slinger	\$5.29	GO-4530000

Johnson Pump CM Series Magnetic Drive Circulating Pump

SPXFLOW
Johnson Pump

- Compact magnetic driven centrifugal pump which combines high flow rates with very low electric current consumption.
- Suitable for fresh water, ethylene glycol and salt water circulation.
- Hose connection 5/8" hose.
- 5.3 GPM at 3.3'.
- Liquid temperature from Minimum -40° C to Maximum +100° C.
- 12 volt.

Order No.	Mfg. No. / Description	List Price
461970	(10-24503-03) CM30P7-1	\$283.59 G0-1009100

Marpac Washdown Pump - 3.5 GPM



- Delivers 3.5 GPM with a maximum pressure of 40 psi.
- Self-priming to 7' 10" (2.4m).
- For fresh or salt water use.
- Automatic high performance pump for deck and anchor washdown.
- Ideal for cleaning pleasure boats, fish boxes, scaling stations, anchor chains and dinghies.
- May also be used for full flow bait tank circulation.
- Automatic pump shut-off feature when hose nozzle is in off position.
- Includes plug-in ports for easy installation: (2) 3/4" hose barb ports and (2) garden hose ports.

Order No.	Description	List Price
7-0900	Washdown Pump	\$222.29 G0-3984100

Rule Slimline In-Line Submersible Pump

rule
a xylem brand

- Container filling and emptying.
- Bilge or storm water emptying.
- Quick diesel transfer with no spillage.
- Suitable for diesel, fresh and salt water.
- Water transfer, deck shower or deck wash.
- Continuous rating but should not be run dry for long periods.
- Includes: Spray nozzle, 13' cable with battery clips and 13' lay flat hose.
- Fully submersible heavy duty construction.
- Outlets: 3/4" ID hose. Pump length 6.5", diameter: 1.5".
- 500 GPH. 12 volt.

Order No.	Mfg. No. / Description	List Price
581707	(IL500PK)	\$114.99 G0-4077000

Marpac Washdown Pump - 5.2 GPM



- Hi capacity, delivers 5.2 GPM at 70 psi for superior performance.
- Self-priming.
- Quiet, efficient, pulsation free and compact.
- Five chamber diaphragm pump that provides superior pressure.
- Strainer uses port connection for simple installation on inlet. (This makes it possible to remove entire unit for a thorough cleaning whenever it is most convenient). Strainer features a transparent cover for simple inspection.
- Easy push-in connections include 3/4" hose barbs and garden hose adapter.
- 12 volt. 3 year warranty. CE certified. Made in USA.

Order No.	Description	List Price
7-0440	Washdown Pump	\$223.19 G0-4594100

Marpac Washdown and Baitwell System



- Includes:
 - (1) 7-0900 - Washdown Pump
 - (1) 581858 - Rule 800 Pump
 - (1) 7-0423 - Coiled Washdown Hose with Nozzle

Order No.	Description	List Price
7-0434	Washdown and Baitwell System	\$360.19 G0-3314200

Flojet General Purpose Pump

FLOJET
a xylem brand

- Four chamber diaphragm for increase performance.
- Quiet operation.
- Very smooth flow.
- Low amp draw.
- Runs dry without damage.
- Self-priming up to 6 ft. suction lift.
- 3.3 GPM.
- Includes: 3/4" hose barbs x quad ports with buna o-rings, port adapters and inline strainer.
- 12 volt.

Order No.	Mfg. No. / Description	List Price
352574	(04105501A)	\$196.99 G0-8913100

Flojet Heavy Duty Deck Wash Pumps

FLOJET
a xylem brand

- Four chamber positive displacement diaphragm design.
- Quiet operation.
- Very smooth flow.
- Low amp drawn.
- Runs dry without damage.
- Self-priming up to 10 ft. suction lift.
- 4.5 GPM.
- Includes: Quick-connect plug-in ports and inline strainer.

Order No.	Mfg. No. / Description	List Price
352714	(04325143L) 12 volt	\$272.79 G0-7728100
352575	(04325043A) 115V AC	\$323.99 G0-7071200
352500	(02090118) Pressure Switch Assembly	\$48.99 G0-2823000

Johnson Pump Aqua Jet Washdown Pumps

SPXFLOW
 Johnson Pump

Order No.	Mfg. No. / Description	List Price
470453	(10-24728-03) 2.9 GPM 2.8 bar - 41 psi 12 volt	\$138.59 G0-6829000
461830	(10-13399-03) 3.5 GPM 5 bar - 70 psi 12 volt	\$181.29 G0-6412100
4610036	(10-13399-04) 3.5 GPM 5 bar - 70 psi 24 volt	\$189.79 G0-6172100
461835	(10-13407-07) 5.2 GPM 5 bar - 70 psi 12 volt	\$230.29 G0-9245100
4610044	(10-13407-08) 5.2 GPM 5 bar - 70 psi 24 volt	\$238.89 G0-6006100

- The quiet and pulsation-free Aqua Jet five-chamber diaphragm wash down pumps provide the perfect wash down solution for cleaning recreational equipment.
- With a higher pressure of up to 5 bar, clean-up is faster and easier than ever before.
- Includes: Spray nozzle, PUMProtector inlet strainer and hose connections for 1/2" hose.
- 1/2" NPT x 3/4" barb, 3/8" BSP x 1/2" barb.
- 3.5 GPM and 5.2 GPM Models includes GHT 3/4" connection.

Johnson Pump Aqua Jet 3.5 GPM Washdown Pump Kit

SPXFLOW
 Johnson Pump

- 5 Chamber Design providing industry leading elimination of vibration and noise dampening.
- Best in Class 70 PSI at the nozzle with flow rate of 3.5 GPM.
- Built in thermal protection to protect from overheating.
- Kit includes:
 - Aqua Jet 3.5 GPM Washdown Pump, 5 bar (70 psi)
 - PUMProtector inlet strainer
 - 25' True 1/2" ID heavy duty coiled hose
 - Ergonomic spray nozzle with quick disconnect fitting
 - Multiple connectors for easy installation
 - Bulk head fitting with valve
 - Illuminated panel switch
- 12 volt

Order No.	Mfg. No. / Description	List Price
470750	(JP-64535)	\$277.19 G0-2758100

Johnson Pump Aqua Jet 5.2 GPM Washdown Pump Kit

SPXFLOW
 Johnson Pump

- 5 Chamber Design providing industry leading elimination of vibration and noise dampening.
- Best in Class 70 PSI at the nozzle with flow rate of 5.2 GPM.
- Built in thermal protection to protect from overheating.
- Kit includes:
 - Aqua Jet 5.2 GPM Washdown Pump, 5 bar (70 psi)
 - PUMProtector inlet strainer
 - 25' True 1/2" Inside Diameter Heavy Duty Coiled Hose
 - Ergonomic Spray Nozzle with Quick Disconnect Fitting
 - Multiple Connectors for Easy Installation
 - Bulk Head Fitting with Valve (64534 Kit Only)
 - Illuminated Panel Switch (64534 Kit Only)
- 12 volt

Order No.	Mfg. No. / Description	List Price
470749	(64534)	\$292.19 G0-7759100
470732	(64534CL) Clam Shell	\$247.39 G0-5756100

Johnson Pump Aqua Jet 4.0 GPM Washdown Pump Kit

SPXFLOW
 Johnson Pump

- 5 Chamber Design providing industry leading elimination of vibration and noise dampening.
- Best in Class 70 PSI at the nozzle with flow rate of 4.0 GPM.
- Built in thermal protection to protect from overheating.
- Kit includes:
 - Aqua Jet 4.0 GPM Washdown Pump, 5 bar (70 psi)
 - PUMProtector inlet strainer
 - 25' True 1/2" ID heavy duty coiled hose
 - Ergonomic spray nozzle with quick disconnect fitting
 - Multiple connectors for easy installation
- 12 volt

Order No.	Mfg. No. / Description	List Price
461850	(64544)	\$234.59 G0-8175100

Johnson Pump Aqua Jet Washdown and Livewell Pump Kit

SPXFLOW
 Johnson Pump

- Kit includes:
 - Aqua Jet 5.2 GPM Washdown Pump, 5 bar (70 psi)
 - 500 GPH Twin Port Livewell Pump
 - PUMProtector inlet strainer
 - Spray nozzle
 - Bulk head fitting with valve
 - 25' of high quality coiled hose
 - Two illuminated panel switches
- 12 volt

Order No.	Mfg. No. / Description	List Price
470751	(64634)	\$373.19 G0-4005200

Jabco PAR-Max Washdown/Baitwell Pump

- Run dry without damage. Smooth flow.
- Four piston, diaphragm pump.
- Powerful heavy duty motor with thermal overload protection.
- Snap-in ports.
- Pressure switch with rubber boot.
- Self-priming up to 10'.
- Port type: 1/2" hose barb. Shut off pressure 50 psi (3.5 bar).
- Also great for continuous duty operation in livewell application at full flow.
- 12 volt.



Order No.	Mfg. No. / Description	List Price
414494	(31700-0092) 4.3 GPM	\$260.39 G0-6447100

Jabco PAR-Max Washdown Pump - 4.0 GPM



- Suitable for high pressure applications.
- New compact 3 chamber design for greater pumping efficiency.
- Self-priming up to 8'.
- Port type: 1/2" hose barb. Shut off pressure 60 psi (4.3 bar).
- Kit includes: Pumpgard intake strainer, pressure nozzle and port fittings.
- ISO 8846 Marine (Ignition Protection).
- 12 volt.

Order No.	Mfg. No. / Description	List Price
414628	(32605-0092) 4.0 GPM	\$177.29 G0-8781100

WASHDOWN PUMP KIT WITH 25' HOSE COIL

Order No.	Mfg. No. / Description	List Price
414780	(32900-0092) 4.0 GPM	\$200.89 G0-0643100

Shurflo Blaster™ II Washdown Pump - 3.5 GPM



- Self-priming up to 6'.
- Sealed switch. Sealed motor.
- Corrosion resistant electro-coated motor.
- Dry run capability. Built-in check valve.
- Ignition protected. Thermally protected.
- Shut-off pressure: 45 PSI.
- Includes: (2) Swivel straight adapter 1/2-14 NPT x 3/4" barb, (1) Swivel straight adapter 1/2-14 NPT x 3/4" NHR (male) and pistol grip plastic spray nozzle.
- 12 volt.

Order No.	Mfg. No. / Description	List Price
353118	(4238-121-E07) 3.5 GPM	\$169.99 G0-9831100

WASHDOWN PUMP KIT - 3.5 GPM

- Includes: 353118 (4238-121-E07) Blaster II Washdown Pump, pistol grip plastic spray nozzle, 25' white coiled hose, swivel nut strainer 1/2" pipe inlet, (2) Swivel straight adapter 1/2-14 NPT x 3/4" barb and (1) garden hose wing nut fitting.

Order No.	Mfg. No. / Description	List Price
353102	(4338-121-E07) 3.5 GPM	\$229.69 G0-9835100

Jabco HotShot Series Washdown Pumps



- New compact 5 chamber design for greater pumping efficiency.
- Ergonomically designed spray nozzle provides powerful and accurate fire power with every shot.
- Quick disconnect ports allow for adjustability and ease of installation.
- Improved noise dampening rubber feet significantly minimizes vibration when mounted against hard surfaces.
- Self-priming up to 8'
- Port type: 3/4" hose barb. Shut off pressure 70 psi (4.8 bar).
- Kits include: Pumpgard intake strainer, pressure nozzle and port fittings.
- ISO 8846 Marine (Ignition Protection).
- 12 volt.

Order No.	Mfg. No. / Description	List Price
414629	(82505-0092) 5.0 GPM	\$233.39 G0-7365100
414630	(82605-0092) 6.0 GPM	\$263.89 G0-1867100
S/O	(18916-1070) Pressure Switch	Price on Request

Shurflo Pro Blaster™ II Washdown Pumps



- Self-priming up to 6'.
- Sealed switch. Sealed motor.
- Corrosion resistant electro-coated motor.
- Dry run capability. Built-in check valve.
- Ignition protected. Thermally protected.
- Shut-off pressure: 60 PSI.
- Includes: (2) Swivel straight adapter 1/2-14 NPT x 3/4" barb, (1) Swivel straight adapter 1/2-14 NPT x 3/4" NHR (male), 50 mesh strainer and pistol grip plastic spray nozzle.
- 12 volt.

Order No.	Mfg. No. / Description	List Price
353160	(4248-153-E09) 4.0 GPM	\$236.49 G0-5485100
353150	(4258-153-E09) 5.0 GPM	\$327.79 G0-2691200

WASHDOWN PUMP KIT - 4.0 GPM

- Includes: 353160 (4248-153-E09) Pro Blaster II Washdown Pump, pistol grip plastic spray nozzle, 25' white coiled hose, raw water strainer, (2) Swivel straight adapter 1/2" NPT x 3/4" barb, (2) swivel straight wing nut 1/2-14 NPT x 3/4" barb, (1) straight fitting 1/2" barb x 1/2" NPT (male) and (1) garden hose wing nut fitting.

Order No.	Mfg. No. / Description	List Price
353172	(4348-153-E09) 4.0 GPM	\$298.99 G0-2300200

- Electronics
- Trolling Motors
- Instruments
- Electrical
- Lighting
- Anchor & Dock
- Safety
- Steering, Controls
- Pumps
- Fuel System
- Seating & Pedestals
- Trailering
- Tops & Covers
- Perform.
- Propellers
- Engine & Care
- Cleaning & Care
- Paint & Paint Acc.
- Fun & Flotation
- Topside Acc.
- Cockpit & Deck
- Hardware, Fasteners
- Camouflage
- Misc.
- Comm.

Marpac Coiled Washdown Hose with Nozzle



- Corrosion resistant construction with stainless steel spring and solid brass fittings.
- No-kink design. Drinking water safe.
- Quick connect fitting with shut off.
- Removable quick connect adaptor.
- 35% more flow at 40 PSI.

Order No.	Description	List Price	
7-0422	1/2" x 15' Coiled Washdown Hose with Nozzle	\$24.99	G0-4761000
7-0423	1/2" x 25' Coiled Washdown Hose with Nozzle	\$29.99	G0-9002000
7-0425	Hose Nozzle with Quick Fitting	\$5.59	G0-5730000

Marpac Corrosion Resistant Hose Nozzle



- Corrosion resistant hose nozzle with adjustable spray pattern.
- Includes removable quick connect fitting with shut off.
- Removable front bumper.
- Molded pistol grip for comfort and control.
- Fits standard garden hose thread.

Order No.	Description	List Price	
7-0425	Hose Nozzle	\$5.59	G0-5730000

Zinc Spray Nozzle



- Zinc alloy spray nozzle with insulated handle.
- Soft grip and front thread protector.
- 5-1/2".

Order No.	Mfg. No. / Description	List Price	
485638	(30-600)	\$19.79	F0-5831000

Perko Water Deck Fill



540333

Camco TastePURE Premium Drinking Water Hose



- Heavy duty reinforced 5/8" ID drinking water hose are 20% thicker than standard hoses.
- Lead-free, drinking water safe.
- Anti-kink design features machined fittings and strain-relief ends for added durability.
- BPA free, phthalate-free formulation.
- UV-stabilized for long life.
- Made with NSF certified hose.

Order No.	Mfg. No. / Description	List Price	
689040	(22833) Length 25'	\$23.79	F0-5661000
689042	(22853) Length 50'	\$36.59	F0-1652000

Camco TastePURE Drinking Water Hose



- Reinforced maximum kink resistance and has an easy grip swivel connector on the female end.
- Made of PVC, this hose is BPA-free, phthalate-free, NSF certified as drinking water safe and delivers water with no plastic taste.
- It is CSA low lead content certified and is compliant with all federal and state level Low Lead Laws.
- 5/8" ID.

Order No.	Mfg. No. / Description	List Price	
771630	(22783) Length 25'	\$15.39	F0-7701000
771700	(22793) Length 50'	\$27.09	F0-6981000

Groco Salt Water Pistol-Grip Nozzle



- The original - the nozzle from which all others are copied.
- Non-corroding plastic nozzle with stainless steel return spring will outlast ordinary hardware store nozzles.

Order No.	Mfg. No. / Description	List Price	
371118	(PGN-50)	\$19.89	G0-3331000

Marpac Water Inlet and Outlet - Stainless Steel



- 316 cast stainless steel.
- 2-3/4" OD.
- For use with 1/2" hose.

Order No.	Description	List Price	
7-0418	Water Inlet	\$40.59	GO-0272000
7-0419	Water Outlet	\$38.79	GO-9952000

Perko Water Fittings



- Chrome plated bronze.
- Black polymer watertight plug and stainless steel bead chain.
- Flange OD 2-3/4".
- Pipe size 1/2".
- Uses #8 fasteners.

INLET FITTING - STANDARD FEMALE SWIVEL HOSE CONNECTOR

- For obtaining water under pressure at dockside.

Order No.	Mfg. No. / Description	List Price	
539429	(0499 DPO CHR)	\$112.39	GO-0357000

OUTLET FITTING - STANDARD MALE HOSE CONNECTOR

- For use with on-board washdown systems.

Order No.	Mfg. No. / Description	List Price	
539444	(0504 DPO CHR)	\$85.49	GO-8275000

Johnson Pump Deck Wash - Quick Connect Fitting



- 316 stainless steel.
- Single flush mount.
- Connects and disconnects under full pressure.
- Positive lock bayonet connector.
- Double viton O-ring seals.
- Large flow capacity.
- Nylon 66 connections.

Order No.	Mfg. No. / Description	List Price	
470072	(JP-61121)	\$127.99	GO-5758000

Shurflo Pressure Reducing City Water Entry



- Chrome.
- Prevents high-pressure damage often caused by city water.
- This high performance water entry limit water pressure and include a built-in check valve.
- 65 PSI.
- Quick, permanent wall mount.
- Continuous protection from high pressure surges.
- Fits standard hose fittings.
- 3/4" GHT female swivel inlet, 1/2" NPSM - male outlet.

Order No.	Mfg. No. / Description	List Price	
7001194	(183-029-14)	\$49.49	GO-6133000

T-H Marine Washdown Fittings



- Injection molded, UV stable, rust proof.
- Standard garden hose threads.
- Protective cap with retainer.
- Fits 3/4" hose.
- Flange dimension 2-1/4" OD.
- Installation in 1-1/4" hole.

BLACK WASHDOWN FITTING

Order No.	Mfg. No. / Description	List Price	
641360	(WDV-1-DP) With Shut-Off Valve	\$36.89	HO-3122000

CHROME PLATED WASHDOWN FITTINGS

Order No.	Mfg. No. / Description	List Price	
641301	(WDV-1CP-DP) With Shut-Off Valve	\$37.89	HO-3722000
772272	(WD-1CP-DP) Without Shut-Off Valve	\$31.79	HO-7091000

Jabsco Water Pressure Regulators



- Protect your boat's water system from damaging pressures of unregulated city water hook-ups.
- Limits inlet water pressure to 45 psi.

FLUSH MODEL

- Includes removable strainer that protects plumbing and fittings.
- Connections for 3/4" GHT (f) inlet and 1/2" - 14 male pipe outlet.

Order No.	Mfg. No. / Description	List Price	
414704	(44412-1045) White	\$46.19	GO-5903000

IN-LINE MODEL

- Compact - only 3" long.
- Connections 3/4" GHT (f) inlet and 3/4" GHT (m) outlet.

Order No.	Mfg. No. / Description	List Price	
414716	(44411-0045) White	\$46.59	GO-2213000

- Electronics
- Trolling Motors
- Instruments
- Electrical
- Lighting
- Anchor & Dock
- Safety
- Steering, Controls
- Pumps**
- Fuel System
- Seating & Pedestals
- Trailering
- Tops & Covers
- Perform.
- Propellers
- Engine & Care
- Cleaning & Care
- Paint & Paint Acc.
- Fun & Flotation
- Topside Acc.
- Cockpit & Deck
- Hardware, Fasteners
- Camouflage
- Misc.
- Comm.

March Seal-Less Magnetic Drive Pumps



496631
496643

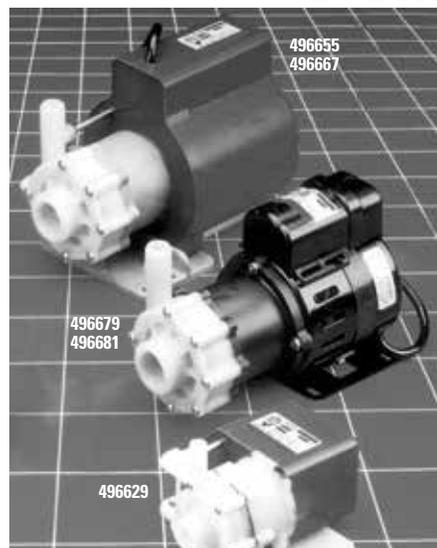

- Electronics
- Trolling Motors
- Instruments
- Electrical
- Lighting
- Anchor & Dock
- Safety
- Steering, Controls

- For use submerged or in damp environments.
- Magnetic drive - no shaft seal to wear, leak, or replace.
- Extremely low energy consumption.
- March epoxy encapsulated circulating pumps with seal-less magnetic drive offer the ultimate in reliability.
- These versatile pumps are widely used on commercial and pleasure craft for recirculating sea water and for air conditioning and refrigeration.
- All models can be run in open air or submerged except model AC-5C-MD, which must be in a dry environment.
- All centrifugal pumps require a flooded inlet (suction side of pump).

SUBMERSIBLE PUMPS

Order No.	Mfg. No.	Volts	Phase	Hz	Watts	Amp	Motor Type	Elec. Connection	Weight Packed
496629	(LC-2CP-MD)	115 volt	1 Phase	50-60 Hz	-	0.92	TE/SUB	6 ft. SJT	5 lbs.
496643	(LC-3CP-MD)	115 volt	1 Phase	60 Hz	-	2.0	TE/SUB	6 ft. SJT	8.5 lbs.
496631	(LC-3CP-MD)	230 volt	1 Phase	60 Hz	-	1.0	TE/SUB	6 ft. SJT	8.5 lbs.
496655	(LC-5C-MD)	115 volt	1 Phase	50-60 Hz	-	1.6	TE/SUB	6 ft. SJT	18 lbs.
496667	(LC-5C-MD)	230 volt	1 Phase	50-60 Hz	-	1.05	TEFC	Conduit Box	9.5 lbs.

NON-SUBMERSIBLE PUMPS - AIR COOLED

Order No.	Mfg. No.	Volts	Phase	Hz	Watts	Amp	Motor Type	Elec. Connection	Weight Packed
496679	(AC-5C-MD)	115 volt	1 Phase	50-60 Hz	-	0.9	TE/SUB	6 ft. SJT	18 lbs.
496681	(AC-5C-MD)	230 volt	1 Phase	50-60 Hz	-	2.1	TEFC	Conduit Box	9.5 lbs.

Pumps

Model No.	Max. Flow	Max. Head	Inlet	Outlet	HP	RPM	Volts	Phase	Hz	Watts	Amp	Motor Type	Elec. Connection	Weight Packed
893-04	2.7 GPM	10.6'	3/8" FPT	3/8" OD	1/150	4,000	12	DC	-	-	1	SUB	Leads	1.2 lbs.
893-06	2.7 GPM	10.6'	3/8" FPT	3/8" OD	1/150	4,000	24	DC	-	-	.05	SUB	leads	1.2 lbs.
LC-2CP-MD	5 GPM	13'	3/8" FPT	1/4" MPT	1/35	3,450	115	1	50/60	-	0.92	TE/SUB	6 ft. SJT	5 lbs.
LC-3CP-MD	8.5 GPM	19'	3/4" FPT	1/2" MPT	1/20	3,450	115	1	60	-	2.0	TE/SUB	6 ft. SJT	8.5 lbs.
LC-3CP-MD-230	8.5 GPM	19'	3/4" FPT	1/2" MPT	1/20	3,450	230	1	60	-	1.0	TE/SUB	6 ft. SJT	8.5 lbs.
LC-5C-MD	14.5 GPM	27'	1" FPT	1/2" MPT	1/8	3,450	115	1	50/60	-	1.6	TE/SUB	6 ft. SJT	18 lbs.
LC-5C-MD-230	14.5 GPM	27'	1" FPT	1/2" MPT	1/8	3,450	230	1	50/60	-	0.9	TE/SUB	6 ft. SJT	18 lbs.
AC-5C-MD	18 GPM	29'	1" FPT	1/2" MPT	1/5	3,450	115	1	50/60	-	2.1	TEFC	Conduit Box	9.5 lbs.
AC-5C-MD-230	18 GPM	29'	1" FPT	1/2" MPT	1/5	3,450	230	1	50/60	-	1.05	TEFC	Conduit Box	9.5 lbs.

- Fuel System
- Seating & Pedestals
- Trailer
- Tops & Covers
- Perform.

Jabco Magnetically Coupled Centrifugal Pumps



- Propellers
- Engine & Care
- Cleaning & Care
- Paint & Paint Acc.
- Fun & Flotation
- Topside Acc.
- Cockpit & Deck
- Hardware, Fasteners
- Camouflage
- Misc.
- Comm.

- Magnetically Coupled Centrifugal Pumps for applications requiring safe, leak-free, continuous duty pumping.
- Designed specifically for marine and industrial markets.
- Typical applications include marine air conditioner circulation, ice makers, hot water circulation, livewell or bait tank installations.
- Pumphead manufactured in chemical resistant thermoplastics entirely non-metallic.
- Magnetic couplings provide an energy efficient thermal shield, minimizing heat transfer to the pumped fluid.
- IPX5 standard motor housing.
- Deep groove ball bearings.
- EPDM O-ring.
- Polypropylene (PP) encapsulated magnet.
- Polypropylene (PP) housing.
- PPS spindle housing.
- Alumina ceramic spindle.

Order No.	Mfg. No. / Description	List Price
417246	(436979) 14 GPM	\$327.99 G0-5791200
417248	(436981) 21 GPM	\$421.39 G0-3328200

Jabco Multi-Outlet Electric Fresh Water Pressure Pump

- Diaphragm design allows dry running.
- Self-priming up to 4.9' vertical lift.
- Built-in discharge check valve.
- Quiet operation.
- Built-in hydraulic pulsation dampener.
- Large vibration absorbing pads.
- Port type: 1/2" or 5/8" ID hose.
- Cut-in at 20 PSI (1.4 bar), cut-out at 40 PSI (2.8 bar).
- 12 volt.



Order No.	Mfg. No. / Description	List Price
414499	(36950-2000) 3 GPM	\$567.19 G0-2008300
425721	(37121-0010) Pressure Switch	\$49.69 G0-9233000

Jabco PAR-Max 1.9 GPM Water Pressure System Pump



- Smooth flow. Dry running capability.
- Soft noise absorbing mounts.
- Built-in bypass-less pulsation.
- Reduces need for accumulator tank.
- Self-priming from dry up to 2.4 m (7.8 ft).
- Shut-off pressure 25 PSI (1.7 bar).
- Includes: (2) 1/2" straight male QEST and (2) 1/2" straight hose barbs.
- 12 volt.

Order No.	Mfg. No. / Description	List Price
418084	(31295-0092) 1.9 GPM	\$126.09 G0-8448000

Jabco PAR-Max 2.9 GPM Water Pressure System Pumps



- Smooth flow. Dry running capability.
- Soft noise absorbing mounts.
- Built-in bypass-less pulsation.
- Reduces need for accumulator tank.
- Self-priming from dry up to 2.4 m (7.8 ft).
- Shut-off pressure 50 PSI (3.4 bar).
- Includes: (2) 1/2" straight male QEST and (2) 1/2" straight hose barbs.
- 2.9 GPM.

Order No.	Mfg. No. / Description	List Price
414603	(31395-0092) 12 volt	\$135.89 G0-5019000
414480	(31395-0094) 24 volt	\$144.89 G0-8079000

Jabco PAR-Max 3.5 GPM Water Pressure System Pump



- Smooth flow. Dry running capability.
- Soft noise absorbing mounts.
- Self-priming from dry up to 3 m (10 ft).
- Shut-off pressure 40 PSI (2.8 bar).
- Includes: (2) 1/2" straight male QEST and (2) 1/2" straight hose barbs.
- 3.5 GPM.

Order No.	Mfg. No. / Description	List Price
414487	(32600-0092) 12 volt	\$186.19 G0-5742100
414488	(32600-0094) 24 volt	\$201.59 G0-7053100

Jabco PAR-Max 4 GPM Water Pressure System Pump



- Smooth flow. Dry running capability.
- Soft noise absorbing mounts.
- Self-priming from dry up to 2.4 m (7.8 ft).
- Shut-off pressure 40 PSI (2.8 bar).
- Includes: (2) 1/2" straight male QEST and (2) 1/2" straight hose barbs.
- 4.3 GPM.

Order No.	Mfg. No. / Description	List Price
414490	(31620-0092) 12 volt	\$248.19 G0-9266100
414492	(31620-0094) 24 volt	\$293.49 G0-4669100

Jabco PAR-Max Plus Water Pressure System Pumps



- Smooth flow. Dry running capability.
- Soft noise absorbing mounts.
- Automatic pressure switch.
- Self-priming from dry up to 3 m (10 ft).
- Shut-off pressure 60 PSI (4.1 bar).
- Includes: 418080 - (2) 1/2" straight male QEST, (2) 1/2" elbow QEST and (2) 1/2" straight hose barbs. 418082 - (2) 3/4" straight male QEST and (2) 3/4" elbow QEST.

5.0 GPM		
Order No.	Mfg. No. / Description	List Price
418080	(82500-0092) 12 volt	\$223.59 G0-1894100

6.0 GPM		
Order No.	Mfg. No. / Description	List Price
418082	(82600-0092) 12 volt	\$254.09 G0-4207100
418083	(82600-0094) 24 volt	\$281.59 G0-7688100

Jabco V-FLO Water Pressure Pump



- Feature the revolutionary new DiMOND technology designed to automatically diagnose and monitor all aspects of your pump's performance to prevent system failure.
- Dry running capability.
- Self-priming from dry up to 3 m (10 ft).
- Variable flow - motor speed increases as increased flow is required.
- No accumulator tank needed.
- Shut-off pressure 60 PSI (4.1 bar).
- Includes: Strainer, (1) 3/4" elbow hose barb, (1) 1/2" elbow hose barb, (2) 3/4" straight QEST and (1) 3/4" elbow QEST.
- 12 volt.

Order No.	Mfg. No. / Description	List Price
414701	(42755-0092) 5.0 GPM	\$390.99 G0-6916200

- Electronics
- Trolling Motors
- Instruments
- Electrical
- Lighting
- Anchor & Dock
- Safety
- Steering, Controls
- Pumps
- Fuel System
- Seating & Pedestals
- Trailering
- Tops & Covers
- Perform.
- Propellers
- Engine & Care
- Cleaning & Care
- Paint & Paint Acc.
- Fun & Flotation
- Topside Acc.
- Cockpit & Deck
- Hardware, Fasteners
- Camouflage
- Misc.
- Comm.

- Electronics
- Trolling Motors
- Instruments
- Electrical
- Lighting
- Anchor & Dock
- Safety
- Steering, Controls
- Pumps
- Fuel System
- Seating & Pedestals
- Trailer
- Tops & Covers
- Perform.
- Propellers
- Engine & Care
- Cleaning & Care
- Paint & Paint Acc.
- Fun & Flotation
- Topside Acc.
- Cockpit & Deck
- Hardware, Fasteners
- Camouflage
- Misc.
- Comm.

Marpac Hi-Capacity Water Pressure System Pump - 5.2 GPM



- Self-priming.
- 41 PSI provided by the five chamber diaphragm pump design.
- Quiet, efficient, pulsation free and compact.
- Easy push-in hose connections include 1/2" hose barbs.
- Includes inlet strainer.
- 12 volt.
- 3 year warranty. CE certified.
- Made in USA.

Order No.	Description	List Price
7-0441	5.2 GPM	\$216.99

Johnson Aqua Jet Water Pressure System Pumps



- The five chamber Aqua Jet WPS provides a reliable heart for small boat and recreational vehicle water pressure system.
- Whisper quiet operation. Self-priming.
- Pressure switch standard.
- Pressure cut off: 41 PSI (2.8 bar).
- Connection: 3/8" NPT/hose 1/2", 1/2" NPT, 3/4" hose.
- Optional inlet strainer 09-24653 before the pump intake.

Order No.	Mfg. No. / Description	List Price
470043	(10-13405-103) 2.9 GPM 12 volt	\$127.99
461954	(10-13395-103) 3.5 GPM 12 volt	\$157.79
4610034	(10-13395-104) 3.5 GPM 24 volt	\$164.19
461956	(10-13406-103) 4.0 GPM 12 volt	\$208.99
461958	(10-13406-107) 5.2 GPM 12 volt	\$223.89

Shurflo Aqua King™ II Standard Fresh Water Pump



- Sealed switch and motor.
- Corrosion resistant electro coated motor.
- 4 independent chambers.
- Built-in check valve.
- Co-molded diaphragm.
- Adjustable switch.
- Self priming up to 6' and run dry capability.
- Ignition and thermally protected.
- Shut off pressure: 55 PSI (3.8 bar).
- Includes: (2) 1/2" barb fittings.
- 12 volt.
- 3 year warranty.
- CE Listed.

Order No.	Mfg. No. / Description	List Price
353100	(4138-111-E65) 3.0 GPM	\$140.69

Flojet Quad DC Water System Pumps



- Four chamber design for increased performance.
- Quiet operation. Very smooth flow.
- Self-priming from dry up to 2.4 m (7.8 ft).
- Shut off at 35 PSI (2.5 bar).
- Quick-connect plug-in ports for easy installation.
- Pressure-switch control to run the pump only as needed.
- Includes plug-in ports for easy installation: (2) 1/2" Qest ports and (2) 1/2" hose barb ports.
- 3.3 GPM.

Order No.	Mfg. No. / Description	List Price
352702	(04405143A) 12 volt	\$176.29
352738	(04405443A) 32 volt	\$201.89
352524	(02090104) Pressure Switch	\$48.99

Johnson Pump Aqua Jet Flow Master Water Pressure System Pump



- Ideal choice for pressurizing water in a closed system.
- The digital controller adjusts water flow as the demand is increased and decreased while maintaining a very smooth flow.
- The unique variable flow feature of the Flow Master pump allows the pump to be mounted w/o an accumulator tank and still maintain an even flow regardless if one or multiple taps are being used.
- Pressure cut off: 50 PSI (3.5 bar).
- Connection: 3/8" NPT/hose 1/2", 1/2" NPT/hose 3/4", 1/2"-14 NPS, 1/2" CTS PEX fitting.
- PumpProtector inlet strainer included.
- 12 volt.

Order No.	Mfg. No. / Description	List Price
461950	(10-13329-103) 5.0 GPM	\$309.19

Shurflo Aqua King™ II Premium Fresh Water Pumps



- Sealed switch and motor.
- Corrosion resistant electro coated motor.
- Independent chambers.
- Built-in check valve.
- Co-molded diaphragm.
- Adjustable switch and by-pass.
- Self priming up to 6' and run dry capability.
- Ignition and thermally protected.
- Shut off pressure: 55 PSI (3.8 bar).
- Includes: (2) 1/2" barb fittings, 50 mesh strainer.
- 12 volt.
- 3 year warranty.
- CE Listed.

Order No.	Mfg. No. / Description	List Price
353122	(4148-153-E75) 4.0 GPM	\$248.29
353146	(4158-153-E75) 5.0 GPM	\$354.29



Flojet High Volume Water Pressure System

FLOJET
a xylem brand



- Integrated pump and accumulator tank system.
- Self-priming up to 10'.
- Can run dry without harm.
- The pump is fully automatic with a built-in switch and check valve to maintain system pressure and will supply smooth water flow from a trickle to full flow.
- Shut off at 40 PSI (2.8 bar).
- May be mounted vertically or horizontally.
- Accumulator tank has total volume of .77 gallon.
- Includes: Pump inlet strainer and assorted ports for easy installation.
- 12 volt.

Order No. Mfg. No. / Description
352726 (02840100A) 4.5 GPM

List Price
\$638.09 GO-2572400

Franklin Water Pressure Systems

- For installations where the vertical distance from the pump to the pumping water level does not exceed 25 feet.
- Cast iron casting and seal plate for durability and long life.
- Pressure switch preset at 30/50 PSI.
- 1-1/4" NPT suction and 1" NPT discharge.
- Pressure gauge included.
- Stainless steel motor shaft and dual ball bearings.
- Precision-engineered thermoplastic impeller, diffuser, nozzle and venturi.
- Clean-out plug to easily unclog nozzle.
- Dual voltage 115/230 volts.



Order No. Mfg. No. / Description

Order No.	Mfg. No. / Description	List Price
496186	(558279) JPH-50-C High Pressure Pump Only 1/2 HP	\$511.69 GO-3824300
496201	(558275MJS75) JP-075-C Standard Pressure Pump Only 3/4 HP	\$723.69 GO-7848400
496194	(558276MJS100) JP-100-C Standard Pressure Pump Only 1 HP	\$677.79 GO-2145400
496190	(604582) RL20 Pressure Tank - 20 Gallon Diameter 16", Length 29"	\$214.69 GO-4834100

Model No.	HP	Total Suction Lift (ft/m)	Pump Capacity GPM Discharge Pressure in PSI										Max. Pressure in PSI
			20	25	30	35	40	45	50	55	60	65	
JPH-50-C	1/2	5 (1.5)	8.8	8.9	8.6	8.4	8.3	8.1	7.4	6.0	4.7	-	80.6
JPH-50-C	1/2	10 (3.1)	7.8	7.7	7.55	7.4	7.25	7.2	6.6	5.4	4.15	-	78.5
JPH-50-C	1/2	15 (4.6)	6.5	6.4	6.3	6.2	6.1	6.0	5.3	4.8	3.6	-	76.3
JPH-50-C	1/2	20 (6.1)	5.3	5.2	5.1	4.9	4.8	4.7	4.6	4.1	2.9	-	74.1
JPH-50-C	1/2	25 (7.6)	3.7	3.65	3.6	3.55	3.5	3.5	3.45	2.4	2.3	-	71.9
JP-075-C	3/4	5 (1.5)	16.2	16	15.8	15.6	15.4	12.1	8.7	5.7	2.9	-	65.0
JP-075-C	3/4	10 (3.1)	14.3	14	13.7	13.5	13.2	10.6	7.6	4.6	1.6	-	62.8
JP-075-C	3/4	15 (4.6)	12.1	11.7	11.3	11.0	10.6	9.3	6.3	3.2	0.2	-	60.6
JP-075-C	3/4	20 (6.1)	9.9	9.6	9.3	9.0	8.7	7.8	4.8	1.9	-	-	58.5
JP-075-C	3/4	25 (7.6)	7.2	7.1	7.0	6.9	6.8	6.7	3.5	0.6	-	-	56.3
JP-100-C	1	5 (1.5)	24.8	24.7	23.2	19.8	16.5	13.1	9.5	6.3	3.4	0.5	66.2
JP-100-C	1	10 (3.1)	21.5	21.2	20.1	18.4	15.2	11.5	7.9	4.9	2.4	-	64.2
JP-100-C	1	15 (4.6)	18.1	17.8	17.4	16.7	13.8	10.3	6.9	4.0	1.3	-	62.1
JP-100-C	1	20 (6.1)	14.4	14.3	14.2	14.6	12.3	9.0	5.3	2.3	0.2	-	60.1
JP-100-C	1	25 (7.6)	10.5	10.5	10.4	10.3	8.8	7.0	4.2	1.3	-	-	57.2

Jabco PAR-Max 4.0 GPM Bilge and Shower Drain Pump



- Self-priming up to 10'.
- Run dry without damage.
- Smooth flow.
- Four piston, diaphragm pump.
- Powerful heavy duty motor with thermal overload protection.
- Self-priming from dry up to 2.4 m (7.8 ft).
- Snap-in ports fittings.
- Connections for 3/4" ID hose.
- Complete with Pumpgard strainer.
- 12 volt.

Order No.	Mfg. No. / Description	List Price
414817	(31705-0092) 4.3 GPM	\$249.19 G0-6966100

Johnson Pump Multiple Port Shower Sump with Ultima Switch



- The shower sump turns on/off automatically using our Ultima switch technology and has multiple inlet ports for handling waste water from more than on tapping point.
- The check valve on the outlet stops water from flowing back into the tank.
- Tank has a tight-fitting lid to minimize splashing and odors.
- Capacity 1.0 m head: 844 GPH. Capacity straight: 972 GPH.
- Discharge connection: 3/4".
- Dimensions: 8.26" W x 11.42" L.
- 12 volt.

Order No.	Mfg. No. / Description	List Price
470067	(57151)	\$132.29 G0-3688000

Jabco Large Pressurized Accumulator Tank



- Will smooth flow from faucets and shower, reducing pump cycling and eliminating pulsations and water hammer.
- Water is totally separated from air chamber by a diaphragm and polypropylene tank liner.
- Mounts horizontally, vertically or even upside down.
- May be fine tuned to cut-in pressure of pump.
- Port: 3/4" NPT (male).
- Diameter 8", height 12-5/8".
- Pre-pressurized to 20 PSI. Maximum working pressure 100 PSI.
- Includes brackets and band clamps.

Order No.	Mfg. No. / Description	List Price
414641	(18810-0000) 2 Gallon	\$258.99 G0-2537100

Rule Shower Drain Boxes



- Sealed polycarbonate lid - tough impact resistant material with gasket to prevent water splash.
- Fast fix system - Lid, pump, filter and float switch can be removed and serviced without tools.
- Threaded port fittings - improves installation by offering several combinations of port fittings including 3/4", 1", 1 1/8", straight and 90° elbow fittings.
- Back flow prevention - Reduces the amount of water that can siphon back to shower box.
- Discharge hose diameter: 3/4".
- Dimensions: 9-1/2" W x 9" L x 5" H.
- 800 GPH.

Order No.	Mfg. No. / Description	List Price
581720	(98B) 12 volt	\$164.99 G0-4501100
582913	(98B-24) 24 volt	\$180.89 G0-0212100
582949	(M-1086) Check Valve	\$9.09 G0-9060000

Groco Pressure Storage Tanks



- A pneumatic pressure charge, matched to the pump cut on pressure prevents water logging by separating the air charge from system water pressure with a rubber bladder.
 - Pipe connection: 3/4" NPT.
 - May be used for fresh or salt water.
 - Tanks may be mounted in any position and anywhere in the cold water plumbing after the pump.
 - Mount hardware is included.
- * Drawdown is measured with 20 PSI air charge and with 40 PSI system water pressure.

Order No.	Mfg. No.	Volume	Diameter	Length	Drawdown*	List Price
375143	(PST-1)	2 Gal.	8"	13"	.5 Gal.	\$191.19 G0-0182100
S/O	(PST-2)	4.4 Gal.	11"	14"	1.4 Gal.	Price On Request
375154	(PST-3A)	10.3 Gal.	15"	19"	3 Gal.	\$609.89 G0-3680400
S/O	(PST-4)	14 Gal.	15"	24"	4.4 Gal.	Price On Request

- Electronics
- Trolling Motors
- Instruments
- Electrical
- Lighting
- Anchor & Dock
- Safety
- Steering, Controls
- Pumps
- Fuel System
- Seating & Pedestals
- Trailering
- Tops & Covers
- Perform.
- Propellers
- Engine & Care
- Cleaning & Care
- Paint & Paint Acc.
- Fun & Flotation
- Topside Acc.
- Cockpit & Deck
- Hardware, Fasteners
- Camouflage
- Misc.
- Comm.

FCI Watermakers Aquamiser+ (250-1,800 GPD)



The Aquamiser Plus Series offers programmable settings and remote display capability through an advanced control marine reverse osmosis system. This value-driven solution is ideal for smaller water production needs. With outputs of 250 to 1800 GPD, the Aquamiser Plus marine watermaker will provide the safety and controls needed to operate both dependably and efficiently. These marine reverse osmosis systems are available in framed and modular configurations to be utilized in tight spaces and bulkheads. Small only in size, the Aquamiser Plus marine R/O unit features extensive controls, including a fully automatic fresh water flush system for unattended maintenance. Scheduled weekly or biweekly flushes will help keep your marine water maker fresh and ready for your next voyage.

STANDARD FEATURES

- Staged starting of motors.
- Timed start-up (Prime, Init, Run).
- TDS monitoring of product water.
- Automatic diverting of water above 500 PPM.
- Programmable Fresh Water Flush for automatic and weekly operation; or, convenient one-touch button for manual operation.
- Overpressure protection (HP fault).
- Loss of Prime/Fouled Filter detection (LP fault).

AQUAMISER PLUS SERIES MODELS

Order No.	Framed	Modular	GPD/LPD	GPH/LPH	HP	KW
S/O	A216S	AM216S	250/946	10/39	1.5	1.50
S/O	A516S	AM516S	500/1892	21/79	1.5	1.50
S/O	A616S	AM616S	600/2270	25/95	1.5	1.50
S/O	A816S	AM816S	800/3027	33/126	1.5	1.50
S/O	A1216S	AM1216S	1200/4541	50/189	2.5	2.24
S/O	A1816S	AM1816S	1800/6811	75/284	2.5	2.24

FCI Watermakers Max-Q+ (700-1,850 GPD)



The Max-Q+ and Max-Q+APC are latest evolution of the Max-Q product line. Our exclusive V4 control system utilizes a high resolution marine-grade 7-inch screen panel with an advanced intuitive interface. Operating and controlling a Watermaker has never been easier. With the optional APC, Automated Pressure Control, making water is literally a touch away.

STANDARD FEATURES

- Voltage: 120/220/380, 1-ph, 3-ph, 50/60 Hz.
- New marine grade 7" high resolution touch screen controller.
- Monitors are Type Approval Certified for marine use by: ABS, FL, Lloyd's Register EMEA, Det Norske Veritas and Russian Maritime Register of Shipping.
- New NMEA 2000 compatible.
- Unique IP address for remote access.
- Built-in, on-screen troubleshooting.
- Small frame footprint.
- Ability to relocate Pressure Vessel Assembly and FWF Assembly to reduce frame footprint.
- 316SS Boost Pump.
- 316SS HP Pump.
- Visual indication of product and brine flow.

- Upgradeable to 1,850 GPD.
- Fully automatic programmable Fresh Water Flush with carbon block filter.
- Standard 40 sq. ft. commercial Pre-filter.
- Dual hertz motors for 50 or 60 hertz operation.
- Multiple display station capabilities.
- 40 sq. ft. of 5 micron pleated filtration.
- Vibration isolation.
- Automatic flush system.
- Washdown duty motors.
- Flow sensors.
- 316SS pressure transducers.
- Pretreatment lockout.

MAX-Q+ SERIES MODELS

Order No.	Framed	Modular	GPD/LPD	GPH/LPH	HP	KW
S/O	MQ726S	MQM726S	700/2649	29/110	2.5	2.29
343204	MQ1226S	MQM1226S	1275/4825	53/201	2.5	2.29
S/O	MQ1826S	MQM1826S	1850/7000	77/292	2.5	2.29

AQ3 REMOTE

- Additional displays enable you to program and access the system from a remote location.
- Dimensions: 5.40" W x 4.10" H x 2.10 D.

Order No.	Mfg. No. / Description	List Price
343232	(50-2185) Universal Reverse Osmosis Controller (UROC)	\$875.00



SPECIAL HANDLING MAY APPLY



- Electronics
- Trolling Motors
- Instruments
- Electrical
- Lighting
- Anchor & Dock
- Safety
- Steering, Controls
- Pumps
- Fuel System
- Seating & Pedestals
- Trailer
- Tops & Covers
- Perform.
- Propellers
- Engine & Care
- Cleaning & Care
- Paint & Paint Acc.
- Fun & Flotation
- Topside Acc.
- Cockpit & Deck
- Hardware, Fasteners
- Camouflage
- Misc.
- Comm.

FCI Watermakers Atlas+ APC (1,400-3,600 GPD)



- Electronics
- Trolling Motors
- Instruments
- Electrical
- Lighting
- Anchor & Dock
- Safety
- Steering, Controls

The Atlas+ Series is the most compact commercial system FCI has to offer. Built on the smaller, marine Max-Q+ platform, it has all the working benefits of its much larger, industrial Neptune+ sibling. The Atlas+ Series is capable of producing 1,400-3,600 GPD and is upgradable throughout the series. The Automated Pressure Control (APC) with manual override puts making pure fresh water, literally, a touch away. At the heart of the system is a durable wash-down duty, 5 HP motor and a robust 316 stainless steel high pressure pump that allow for extended run times. When installation space or generator size is limited, the Atlas+ Series truly encompasses the best of both pleasure boating and commercial worlds.

ATLAS+ SERIES MODELS

Model	GPD/LPD	M3	GPH/LPH
AT14263+/AT14263+APC	1400/5298	5	58/221
AT20263+/AT20263+APC	2000/7568	8	83/315
AT25263+/ AT25263+APC	2500/9460	9	104/394
AT28263+/ AT28263+APC	2800/10595	11	117/441
AT36263+/ AT36263+APC	3600/13622	14	150/568

STANDARD FEATURES

- Power supply options: 208-220, 3-ph, 60 Hz, 380-415, 3-ph, 50 Hz or 440-480, 3-ph, 60 Hz.
- 7" touch screen: High resolution HMI, marine grade and bridge certified.
- TEFC continuous-duty washdown rated motors with 316SS shaft and sealed maintenance-free bearings for long life applications.
- LP Feed Pump: Closed impeller design offers 50% more pressure efficiency over standard pumps.
- Electrical: NEMA 4X rated enclosure.
- Open Frame Design: Allows easy visual inspection and access for maintenance.
- Fresh Water Flush: Schedule automated flushes through the V4 Control.
- Shock Mounts: Installed on frame and motor to reduce noise and vibration.
- Membranes: High rejection non-proprietary membranes used to obtain the highest quality of product water.
- Automatic Pressure Control (APC): Auto-adjusts system pressure to feed water conditions.
- High Pressure Pump: Extended-duty 316SS HP pump.
- Product Vessels: 316SS product/pressure ports and FDA/NSF-51 fittings used on the product water.
- Pre-filter: 40 sq. ft. of pleated filter with PVC core in addition to pressure monitoring and alarming.

Pumps

- Fuel System
- Seating & Pedestals
- Trailer
- Tops & Covers
- Perform.
- Propellers
- Engine & Care
- Cleaning & Care
- Paint & Paint Acc.
- Fun & Flotation
- Topside Acc.
- Cockpit & Deck
- Hardware, Fasteners
- Camouflage
- Misc.
- Comm.

FCI Watermakers Neptune+ - Modular (1,275-9,500 GPD)



Since its inception, the FCI Neptune+ Series has been recognized for its high efficiency and extreme reliability. With output capacities ranging from 1,275 to 9,500 GPD, it has established itself as a dependable workhorse by utilizing premium components: 316SS pumps, commercial filtration, NEMA 4X electrical enclosures, slow turning HP pumps, pressure vessels with 6x the safety factor and industry-leading certified control systems. When you add Automated Pressure Control, and the corresponding media filtration skid, the Neptune+APC is the optimum system with automated watermaking at your fingertips. The Neptune+ Modular system allows flexible installation options, which make it deals for commercial vessels, island homes, oil platforms, hotels or large yachts with limited operating space.

NEPTUNE+ - MODULAR SERIES MODELS

Module	GPD/LPD	M3	GPH/LPH	HP	KW
NM12263+ APC	1275/4826	4.83	53/201	3	2.98
NM18263+ APC	1850/7003	7.00	77/291	3	2.98
NM25263+ APC	2500/9463	9.47	104/394	5	4.58
NM31263+ APC	3100/11734	11.74	129/488	7.5	6.48
NM43263+ APC	4300/16277	16.29	179/678	7.5	6.48
NM55263+ APC	5500/20819	20.83	229/867	7.5	6.48
NM75263+ APC	7500/28391	28.41	312/1182	10	8.39
NM95263+ APC	9500/35961	35.98	395/1497	10	8.39

STANDARD FEATURES

- Power supply options: 208-230, 3-ph, 60 Hz, 380-415, 3-ph, 50 Hz or 440-480, 3-ph, 60 Hz.
- 7" high resolution HMI touch screen that is marine grade and bridge certified.
- Pre-Filter: 80 sq. ft. of pleated filter with PVC core.
- Pressure gauges and flow meters.
- Frame: Aluminum powder coated frame.
- Automatic Pressure Control (APC): Auto-adjusts system pressure to feed water conditions.
- Membranes: High rejection non-proprietary membranes used to obtain the highest quality of product water.
- Electrical: NEMA 4X rated enclosure with overload protection on low pressure and high pressure pump.
- Product Vessels: 316SS product/pressure ports and FDA/NSF-51 fittings used on the product water.
- LP/Feed Pump: Closed impeller design offers 50% more pressure efficiency over standard pumps.
- Motors: TEFC continuous-duty wash down rated motors with 316SS shaft and sealed, maintenance-free bearings for long life applications.
- High Pressure Pump: Continuous-duty 316SS HP pump with Pulsation Dampener.
- Shock Mounts: Reduce noise and vibration.
- Fresh Water Flush: Schedule automated flushes through the V4 Control.



FCI Watermakers Neptune+ - Horizontal (1,275-9,500 GPD)

STANDARD FEATURES

- Voltage: 220/380/460, 3-ph, 50/60 Hz.
- Advanced marine grade 7" high resolution touch screen controller.
- Monitors are Type Approval Certified for marine use by: ABS, GL, Lloyd's Register EMEA, Det Norske Veritas and Russian Maritime Register of Shipping.
- New NMEA 2000 compatible.
- Unique IP address for remote access.
- Built-in, on-screen troubleshooting.
- 316SS Low-pressure Pump with closed impeller design (producing 50% more pressure with the same horsepower).
- 316SS HP Pump.
- Commercially designed to operate 24/7, 365 days per year.
- Pressure Vessels with 316SS pressure and product ports, stress-eliminating engineering.
- 80 sq. ft. of Commercial Pre-filtration.
- Conservatively rated to ensure performance under varying conditions.
- Wash-down duty motors (epoxy coated, neoprene gaskets).
- Dual isolation mounts: 6 each on the pump and motor skid and 6 on the main frame.



Since its inception, the FCI Neptune+ Series has been recognized for its high efficiency and extreme reliability. With output capacities ranging from 3,400 to 10,000 GPD and a dependable Direct Drive High Pressure Pump, it has proven to be a dependable workhorse by utilizing premium components: 316SS pumps, commercial filtration, NEMA 4X electrical enclosures, pressure vessels with 6x the safety factor and industry-leading certified control systems. When you add Automated Pressure Control and the corresponding media filtration skid, the Neptune+ APC is the optimum system with automated watermaking at your fingertips. Ideal for commercial vessels, island homes, oil platforms, hotels or large yachts.

NEPTUNE+ - HORIZONTAL SERIES MODELS

Horizontal	GPD/LPD	M3	GPH/LPH	KW
NH34263+/NH34263+APC	3400/12870	12.88	141/533	14.8
NH46263+/NH46263+APC	4600/17412	17.42	191/723	14.8
NH58263+/NH58263+APC	5800/21955	21.97	241/912	14.8
NH80263+/NH80263+APC	8000/30283	30.30	333/1260	14.8
NH10263+/NH10263+APC	10000/37854	37.88	416/1574	14.8

FCI Watermakers Neptune+ OG (3,400-10,000 GPD)

STANDARD FEATURES

- Power supply options: 208-230, 3-ph, 60 Hz, 380-415, 3-ph, 50 Hz or 440-480, 3-ph, 60 Hz.
- 7" touch screen: High resolution HMI, marine grade and bridge certified.
- Frame: 6061 aluminum or 316 stainless steel, open frame.
- Bag filter: 25 micron filter with pressure differential monitoring and alarming.
- Disconnect: Externally mounted for quick and easy access; OSHA approved lockout switch.
- Forklift slots: Prevents damage to frame.
- Pressure gauges and flow meters.
- Direct drive motor: Continuous-duty with no belts to adjust, align or replace.
- Pre-filter: 120 sq. ft. area with pressure differential monitoring and alarming.
- APC: Automatic Pressure Control system auto-adjusts system pressure to feed water conditions.
- Electrical enclosure: 316 stainless steel, NEMA 4X, Class I Div II Standard.
- Pipe Supports: Added reinforcements to protect plumbing.
- Protection: All components safely mounted within the frame.
- Lifting Eyes: Mounting positions for lifting or storage.



The Neptune+ OG line is our newest development in the Neptune Series of watermakers. The rugged design addresses the demanding needs of the Oil and Gas industry, Rental Fleets, Isolated Island applications or anywhere environmental conditions require solid engineering and trouble-free operation. Building on the foundation and excellent rack record of the Neptune+APC, we've increased filtration, added FRP cluster housings and direct drive pumps. The frame with built-in lifting eyes, comes in 316 Stainless Steel or 6061 Aluminum. Our V4 HMI control system is fully automated and customizable through a marine grade, high resolution Touch Screen. Enclosures are completely NEMA 4X compliant and explosion proof ratings are also available. Couple this unit with its corresponding media filtration skid and you'll have the optimal system.

NEPTUNE+ OG SERIES MODELS

Horizontal	GPD/LPD	M3	GPH/LPH
NHOG34463+ APC	3400/12870	12.88	142/538
NHOG47463+ APC	4750/17981	18.00	198/750
NHOG60463+ APC	6000/22713	22.73	250/947
NHOG72463+ APC	7200/27255	27.27	300/1136
NHOG80463+ APC	8000/30283	30.30	334/1265
NHOG90463+ APC	9000/34069	34.10	375/1420
NHOG100463+ APC	10000/37854	37.88	417/1579

FCI Watermakers Neptune+ - Accessories

Order No.	Mfg. No. / Description	List Price	Order No.	Mfg. No. / Description	List Price
343223	(20-2261) Filter Cart. - 5 Micron 5" x 13"	\$68.75 A0-5786000	343213	(20-0019) Filter Cart. - 5 Micron 2-1/2" x 9-3/4"	\$11.00 A0-0011000
343226	(48-0199) Cat Pump Oil Pint	\$12.70 A0-0721000	343216	(20-0020) Filter Cart. - 20 Micron 2-1/2" x 9-3/4"	\$11.00 A0-0011000
343229	(48-2374) Oil Pint	\$12.70 A0-0721000	343219	(20-0025) Carbon Filter 2-1/2" x 9-3/4"	\$15.75 A0-5751000



FCI Watermakers Poseidon+ (10,000-26,500 GPD)



- Electronics
- Trolling Motors
- Instruments
- Electrical
- Lighting
- Anchor & Dock
- Safety
- Steering, Controls

The Poseidon+ marine reverse osmosis system is the industry's choice when commercial applications call for substantial capacities of fresh water. This high output unit features unrivaled quality and superior manufacturing with proven reliability in the most demanding of applications. The frame is powder coated aluminum with built-in forklift slots and lifting eyes are optional. Our V4 HMI control system is fully automated and customizable through a marine grade, high resolution Touch Screen mounted in a stainless steel enclosure, which is NMEA 4X compliant. With production ranges from 14,265 - 27,210 GPD, capacity can be easily re-configured with additional vessels. The Poseidon+ is commonly used around the world on offshore oil platforms, petroleum support vessels, commercial ships, military vessels, mid-sized hotels, island applications and various remote necessities.

For over three decades, FCI Watermakers has been pioneering technologies and manufacturing the most reliable, trouble-free watermaking systems for the offshore and boating industries. Each unit is manufactured and live-tested in our facility. Your system comes with piece of mind and a readily available customer service and technical support team. Our worldwide service network ensures proper maintenance and unrivaled satisfaction.

STANDARD FEATURES

- Voltage: 220/380/460, 3-ph, 50/60 Hz.
- State-of-the-art engineering.
- Next generation advanced touch screen controller with complete system readouts.
- 316SS high-pressure pump.
- Multiple display station capabilities.
- Built-in media filtration.
- 120 sq. ft. of 5 micron pleated filtration.
- Pulsation dampener.
- Timing belt drive system.
- Vibration isolation.
- Automatic Flush System.
- TEFC Motors.
- Thermal overload protection.
- Flow meters and flow sensors.
- 316SS pressure transducers.
- Pretreatment lockout.

Horizontal	GPD/LPD	M3	GPH/LPH	Recovery Rate %
P54463+	14,265/53,999	54	417/1,578	24
P65463+	17,171/64,999	65	521/1,972	29
P81463+	21,397/80,996	81	667/2,525	37
P103463+	27,210/103,001	103	792/2,998	47

- Pumps
- Fuel System
- Seating & Pedestals
- Trailer
- Tops & Covers
- Perform.
- Propellers
- Engine & Care
- Cleaning & Care
- Paint & Paint Acc.
- Fun & Flotation
- Topside Acc.
- Cockpit & Deck
- Hardware, Fasteners
- Camouflage
- Misc.
- Comm.



DOCKSIDE TREATMENT SYSTEM

The FCI Dockside Treatment System (DTS) is another FCI Watermakers innovation, specifically designed to treat dock water. The FCI DTS+Solo is a stand-alone dockside water purifying unit allowing you enjoy fresh purified drinking, cooking, and bath water from your dockside source. Its compact, modular design allows it to be tucked away just about anywhere. This advanced system includes a GAC and sediment filter, making it optimized for extended membrane life, which means less maintenance, lower operating costs and more enjoyment out on the water. The FCI DTS+Solo eliminates viruses, bacteria, and cysts. It also removes up to 99% of total dissolved solids (TDS), causing surfaces to dry without leaving water spots. Spend less time wiping down your vessel, and relish the benefits of spot-free wash-downs to extend the life of your vessel's paint and wax finish. The FCI Dockside Treatment System encompasses all of the qualities and reliability you have come to know with FCI Watermakers.



PURIFY DOCK WATER WITH ONE CONVENIENT UNIT

BENEFITS:

- Purified dock water for drinking, cooking, and bathing with no equipment on the dock needed
- Removes up to 99% of TDS
- Removes viruses, bacteria, and cysts
- Spot-free wash-down saves time, with no need to chamois-dry surfaces
- Extends your vessel's paint and wax life
- Compact, space-saving design
- Pumps and motors included
- Extremely low power consumption
- Exceptionally low noise and vibration
- Wall- or deck-mountable

Basket Strainer and Tailpiece

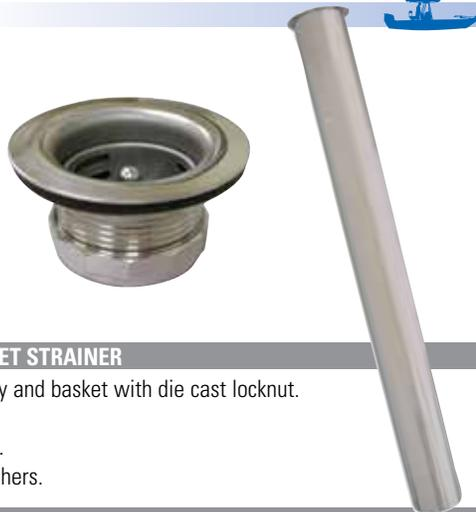

JUNIOR DUO BASKET STRAINER

- Stainless steel body and basket with die cast locknut.
- Threads: 1-1/2".
- Fits 1-3/4" bar sink.
- Complete with washers.

SINK TAILPIECE

- Chrome plated brass - 22 gauge.
- Dimensions: 1-1/2" x 4".

Order No.	Mfg. No. / Description	List Price
541068	(DUPLEX/1H4FL)	\$22.98 HO-9731000

Johnson Pump Water Pressure Pump - 1.1 GPM

SPXFLOW
Johnson Pump



- Self priming diaphragm style demand pump
- Great for bar sinks.
- Can be mounted above water tank.
- Easy access, low maintenance.
- For single tap use.
- 1.1 GPM.
- 12 volt.

Order No.	Mfg. No. / Description	List Price
461957	(10-22020-101)	\$74.69 G0-4005000

Jabco ParMax 1 Plus Faucet and Pump



NEW ITEM

- IP (Ingress Protection) rated cover and quick fit ports improves the installation process.
- Flow rates up to 1.0 GPM (3.8 LPM.) and operating pressures up to 35 PSI (2.4 bar).
- Demand (pressure switch shut-off).
- Provide dependable run dry capabilities, extending the life of the pump.
- Self-priming up to 6 ft. (1.8m).
- Built in thermal protector, prevents overheating to protect the pump from damage.
- Quick disconnect ports allow for quick cleaning and easy hose replacement in seconds.
- John Guest 1/4" to snap fit port (pump), 3/8" NPT male to John Guest 1/4".
- 12 volt.

Order No.	Mfg. No. / Description	List Price
417251	(42630-2992-P)	\$103.39 G0-7296000

KIT INCLUDES PUMP, FAUCET AND 20' OF 1/4" TUBING

Order No.	Mfg. No. / Description	List Price
417252	(42630-3992-P)	\$156.99 G0-8150100

Kuuma Products Water Heaters

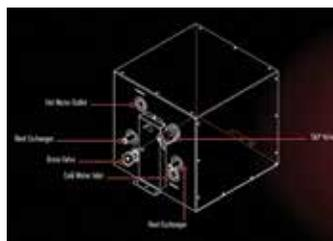

- Marine quality aluminum alloy case with TIG welded.
- Heat exchanger position/material: Front/Aluminum.
- Mount arrangement: Front/rear.
- Large diameter dual loop heat exchanger is standard.
- High temp limiter with automatic reset after breaker cycle.
- ETL listed to UL 174.
- 120V-60Hz/1500W.

Order No.	Mfg. No.	Gallon	Dimensions	List Price
609101	(11811)	6 Gal.	13-3/4" x 13-5/8" x 19-3/4"	\$377.99 F0-9546200
609202	(11841)	11 Gal.	16-1/4" x 16-1/4" x 23-1/4"	\$497.99 F0-9584300

- Electronics
- Trolling Motors
- Instruments
- Electrical
- Lighting
- Anchor & Dock
- Safety
- Steering, Controls
- Pumps**
- Fuel System
- Seating & Pedestals
- Trailering
- Tops & Covers
- Perform.
- Propellers
- Engine & Care
- Cleaning & Care
- Paint & Paint Acc.
- Fun & Flotation
- Topside Acc.
- Cockpit & Deck
- Hardware, Fasteners
- Camouflage
- Misc.
- Comm.



Long Lasting Trouble Free Water Heaters

■ ABS Approved

■ Non ABS



■ Model ME/MSE
Storage Small Capacity
 Electric water heater, 6 -120 gallon. Up to 58 KW in all 3 phase voltages. Available in cement lined steel or copper-alloy tank. USCG compliant and ABS approved.



■ Model E
Storage Small Capacity
 Vertical electric storage tank water heater, 6-119 gallon capacity. Up to 6 KW in all 1 phase voltages. Available in cement lined, steel or copper-alloy tank.



■ Model MTX/MTXA
Tankless
 High efficiency compact electric tankless water heater provides an endless flow of hot water. Significantly reduces weight and saves space. Available up to 54 KW in 1 or 3 phase voltages.



■ Model HX/TX/TXA
Tankless
 High efficiency compact electric tankless water heater provides an endless flow of hot water. Available up to 171 KW in 1 or 3 phase voltages.



■ Model MSH
Storage Large Capacity
 Vertical or horizontal packaged electric water heater, 80-5000 gallon capacity. Full range of KW ratings in all 1 or 3 phase voltages. ASME Stamped. USCG compliant and ABS approved.



■ Model SH
Storage Large Capacity
 Vertical or horizontal packaged electric water heater 80-5000 gallon capacity. Full range of KW ratings in all 1 or 3 phase voltages. ASME stamped.

■ Small Point-of-Use



■ Model CE2.5
Point-of-Use
 Compact electric water heater installs directly under fixture, 2 gallon capacity. Up to 3,000 watts at 240 volt, 1 phase. Stainless steel tank provides maximum longevity.



■ Model CE110
Point-of-Use
 Compact electric water heater installs directly under fixture, 1 gallon capacity. Up to 1,000 watts at 120 volt, 1 phase. Stainless steel tank provides maximum longevity.

- Electronics
- Trolling Motors
- Instruments
- Electrical
- Lighting
- Anchor & Dock
- Safety
- Steering, Controls
- Pumps**
- Fuel System
- Seating & Pedestals
- Trailer
- Tops & Covers
- Perform.
- Propellers
- Engine & Care
- Cleaning & Care
- Paint & Paint Acc.
- Fun & Flotation
- Topside Acc.
- Cockpit & Deck
- Hardware, Fasteners
- Camouflage
- Misc.
- Comm.

Marpac Self-Contained Portable Toilets

- High-density polyethylene construction is corrosion proof.
- No external connections required.
- High efficiency piston pump uses as little as 50ml to flush.
- Double seal valve eliminates leakage and odors.
- Quick emptying with easy-pour spout.
- Matte finish conceals scratches and is easy to clean.
- T-type flush nozzle improves flow circle while saving water.

DIMENSIONS: 16-1/4" D x 13-15/16" W x 12-1/4" H

Order No.	Description	List Price
7-0009	2.6 Gallon - Includes: Tie Down Bracket	\$114.49 GO-1767000
7-0007	Hold Down Bracket for 7-0009	\$15.49 GO-8301000

DIMENSIONS: 16-1/4" D x 13-15/16" W x 16-1/4" H

- Waste tank level indicator shows when holding tank is full.
- Exhaust valve for a smooth, even flow when emptying wastewater.

Order No.	Description	List Price
7-0010	5.2 Gallon	\$124.79 GO-1638000

REPLACEMENT PARTS

Order No.	Description	List Price
7-9909	Replacement Slide Valve	\$17.69 GO-5811000
7-9910	Replacement Fresh Water Tank Cap	\$3.69 GO-7420000
7-9911	Replacement Waste Tank Cap	\$3.69 GO-7420000
7-9912	Replacement Tank Gasket	\$1.89 GO-7210000



Thetford Porta Potti® 135 Portable Toilet



- Modern appearance.
- Ergonomic carrying handle.
- Standard lid latch.
- Durable, easy to use and easy to clean.
- Removable seat and cover for easy cleaning.
- Exclusive, rotating Pour-Out Spout.
- Bellows pump flush.
- Sealed valve keeps odors in holding tank.
- Deodorant sample included.
- Dimensions: 12.2" H x 13.5" W 15" D.
- Capacity: 2.6 gallons.
- Average flushes: 27.
- **Caution:** Do not use stiff brushes or homemade products to clean or lubricate the valve and seal of your portable toilet, as these will damage the seals and surfaces, causing odors to escape from holding tanks.

Order No.	Mfg. No. / Description	List Price
028147	(92861)	\$129.99 ZO-9909000

Thetford Porta Potti® 550P Portable Toilet



- Designed to make dockside pumpout a breeze.
- This durable toilet is sanitary, odorless and leakproof.
- High-gloss finish is easy to clean.
- Piston pump flushes fresh water to clean bowl.
- Sealed valve keeps odor in holding tank.
- Built-in deodorant storage (bottle included).
- Hold down kit secures toilet to deck.
- Easy-to-read level indicator.
- Refreshed, modern appearance.
- Cleaner seat and cover design.
- More-ergonomic.
- Carrying handle.
- Lid latch now standard.
- Redesigned valve handle, fill cap and pump.
- Capacity: Fresh water tank: 4.0 gallons. Waste water tank: 5.5 gallons.
- Average flushes: 56.

Order No.	Mfg. No. / Description	List Price
028185	(92856)	\$233.39 ZO-7365100

- Electronics
- Trolling Motors
- Instruments
- Electrical
- Lighting
- Anchor & Dock
- Safety
- Steering, Controls
- Pumps**
- Fuel System
- Seating & Pedestals
- Trailering
- Tops & Covers
- Perform.
- Propellers
- Engine & Care
- Cleaning & Care
- Paint & Paint Acc.
- Fun & Flotation
- Topside Acc.
- Cockpit & Deck
- Hardware, Fasteners
- Camouflage
- Misc.
- Comm.

Jabsco Twist 'n' Lock Manual Toilets



- Hygienic white ceramic bowl for ease of cleaning.
- Baked enamel wooden seat.
- Twist 'n' Lock safety handle and flush control lever.
- Powerful swirl action for efficient flushing.
- Full sized external seal housing allows quick clean seal replacement and instant access to pump cylinder.
- Powerful self-priming pump for above or below waterline installation.
- Crevice free contours and smooth mouldings for added hygiene.
- Automatic vacuum breaker for easier pumping.
- Angled pump housing and long stroke for ease of installation.
- Reversible pump mounting for choice of right or left handed installation.
- Connections for 3/4" ID inlet hose and 1-1/2" outlet hose.

COMPACT SIZE TOILET - 17.91" W x 16.23" D x 13" H

Order No.	Mfg. No. / Description	List Price	
414906	(29090-5000)	\$221.59	E0-9166100

HOUSEHOLD (REGULAR) SIZE TOILET - 18.50" W x 19.09" D x 13.58" H

Order No.	Mfg. No. / Description	List Price	
414918	(29120-5000)	\$281.59	G0-7688100

SERVICE KITS

Order No.	Mfg. No. / Description	List Price	
414920	(29045-0000) Up to 1997	\$95.69	G0-1146000
414932	(29045-2000) From 1998 to 2007	\$93.89	G0-1926000
414935	(29045-3000) From 2008 to Current	\$96.49	G0-5646000

Jabsco Lite Flush Electric Toilets



- Space saving stylish design.
- Compact size, rotatable seat.
- Virtually silent operation.
- Choice of leaving bowl wet or dry after use.
- Uses less than 1.0 amp/hour per day.
- Raw water only.
- Self-priming from dry up to 3 m (10 ft).
- Slow close seat and lid.
- Connections for 3/4" ID inlet hose and 1-1/2" outlet hose.
- Low water usage - 1.2 litres (1.3 US Quarts) per flush.
- Non-clogging large bore flush pump macerates waste.
- Ceramic bowl and plastic outer for light weight construction.
- Dimensions: 13-1/2" W x 15-3/4" D x 14-3/4" H.
- Complies with USCG 183.410 and ISO 8846 MARINE (Ignition protection).
- 12 volt.



Order No.	Mfg. No. / Description	List Price	
414985	(58500-0012) Foot Switch	\$736.29	E0-2225500
414988	(58500-1012) "One Touch" Control Panel	\$930.09	G0-6132600

Jabsco Electric Marine Toilets



- Hygienic white ceramic bowl for ease of cleaning.
- Baked enamel wooden seat.
- Flushing pump self-priming up to 4'.
- May be mounted 3' below the waterline.
- Built-in back flow preventer.
- Stainless steel and bronze fastenings for reliable saltwater service.
- Equally suitable for overboard or holding tank discharge.
- Connections for 5/8" to 3/4" ID inlet hose and 1" or 1-1/2" outlet hose.
- Complies with USCG 183.410 and ISO 8846 MARINE (Ignition protection).
- 12 volt.

COMPACT SIZE TOILET - 13-7/8" W x 17-3/4" D x 13-13/16" H

Order No.	Mfg. No. / Description	List Price	
414956	(37010-3092)	\$551.49	E0-2631400

HOUSEHOLD (REGULAR) SIZE TOILET - 14-3/4" W x 19-3/4" D x 14-5/8" H

Order No.	Mfg. No. / Description	List Price	
414970	(37010-4092)	\$548.79	E0-9511400

REPAIR KITS AND REPLACEMENT PARTS

Order No.	Mfg. No. / Description	List Price	
415011	(37040-0000) Service Kit - Seals and O-rings	\$71.09	G0-3674000
415023	(37041-0010) Motor/Pump Assembly, 12 volt	\$321.59	G0-7451200
415035	(37064-0000) Motor, 12 volt	\$206.09	G0-8083100

Jabsco Deluxe Flush Electric Toilet



- The stylish and extremely compact design is carefully contoured to conceal the flush pump, wiring and plumbing, whilst still featuring a full-size household seat.
- Virtually silent operation for comfort onboard.
- The 17" Slanted Back gives minimal footprint and makes it easy to mount against a sloping surface or in a corner.
- Features a multifunction 'one touch' control pad.
- Choice of four rinse options for minimum water usage 1.5 US quarts.
- High vitreous china bowl.
- No "dirt traps" for maximum hygiene and easy cleaning.
- Supplied with a solenoid valve and siphon breaker assembly for connection to any existing pressurized water system capable of delivering 2.9 US gpm (11 lpm) or more.
- The siphon breaker ensures there is no backflow from the toilet into the water system.
- Connections for 3/4" ID inlet hose and 1-1/2" outlet hose.
- Dimensions: 14-1/2" W x 17-1/2" D x 17-1/4" H.
- Complies with USCG 183.410 and ISO 8846 MARINE (Ignition protection).
- 12 volt.

Order No.	Mfg. No. / Description	List Price	
414982	(58020-1012)	\$1,048.09	G0-2220700



Jabco Electric Toilet Base Kit

- Convert our Manual Toilet Compact and Regular bowl models to full electric operation without need to alter existing inlet or discharge seacocks.
- Also converts most toilets with 4 bolt screw pattern on a 3-3/4" diameter bolt circle such as Groco, Raritan, Wilcox Crittenden, Mansfield and Sealand.
- Push button flushing for ease and simplicity of operation.
- Comprehensive kit has all necessary parts, including flushing pump, macerator pump, switch, adapters, clamps, hose and fastenings.
- Flushing pump self-priming up to 4' vertical lift.
- May be installed 3' below the waterline.
- 5/8" to 3/4" inlet, 1" outlet back flow check valve in discharge.
- Dimensions: 13-1/4" L x 8-1/4" W x 3-1/4" H.
- Complies with USCG 183.410 and ISO 8846 MARINE (Ignition protection).
- 12 volt.



Order No. Mfg. No. / Description
415085 (37010-0092)

List Price
\$575.99 GO-1958300

Johnson AquaT™ Silent Electric Compact Toilet



- Made from white vitreous porcelain, and with corrosion resistant parts throughout, the AquaT marine toilet, is quiet, robust and easy to clean.
- Equipped with 12 volt Aqua Jet pump.
- Equipped with soft closing, durable and hygienic plastic seat.
- Self-priming pump.
- May be installed above or below the waterline.
- Automatic back-flow prevention.
- Whisper quiet operation.
- Low water consumption (2-2.5 litres per flush).
- Includes: Two switch control panel for separate rinse and discharge.
- Outlet ports: 1-1/2" and 1". Inlet ports: 3/4".
- Dimensions: 17.7" D x 13.4" W x 15.7" H.
- 12 volt.

Order No. Mfg. No. / Description List Price
470081 (80-47231-01) **\$498.69** E0-2047300

Johnson AquaT™ Standard Electric Compact Toilet



- Made from white vitreous porcelain, and with corrosion resistant parts throughout, the AquaT marine toilet, is quiet, robust and easy to clean.
- Equipped with soft closing, durable and hygienic plastic seat.
- Self-priming pump.
- Low water consumption (2-2.5 litres per flush).
- May be installed above or below the waterline.
- Automatic back-flow prevention.
- Equipped with a combined pump unit for disposal and flushing.
- Includes: One touch control panel.
- Outlet ports: 1-1/2" and 1". Inlet ports: 3/4".
- Dimensions: 17" D x 13.6" W x 15.4" H.
- 12 volt.

Order No. Mfg. No. / Description List Price
470083 (80-47435-01) **\$370.09** E0-7577200

Johnson AquaT™ Manual Compact Toilet



- Made from white vitreous porcelain, and with corrosion resistant parts throughout, the AquaT marine toilet, is quiet, robust and easy to clean.
- Ergonomically designed, hand-powered piston pump that can be mounted for either left-hand or right-hand use.
- Equipped with soft closing, durable and hygienic plastic seat.
- Self-priming pump.
- May be installed above or below the waterline.
- Automatic back-flow prevention.
- Innovative brake bushing prevents annoying leakage at the handle.
- Low water consumption (2-2.5 litres per flush).
- Outlet ports: 1-1/2" and 1". Inlet ports: 3/4".
- Dimensions: 16.1" D x 17.9" W x 14" H.

Order No. Mfg. No. / Description List Price
470079 (80-47229-01) **\$171.39** E0-4582100

Groco Joker Valve



- For use with Groco Model HF Series Marine Toilets.

Order No. Mfg. No. / Description
377956 (H-27-A)

List Price
\$9.39 GO-9260000

- Electronics
- Trolling Motors
- Instruments
- Electrical
- Lighting
- Anchor & Dock
- Safety
- Steering, Controls
- Pumps**
- Fuel System
- Seating & Pedestals
- Trailering
- Tops & Covers
- Perform.
- Propellers
- Engine & Care
- Cleaning & Care
- Paint & Paint Acc.
- Fun & Flotation
- Topside Acc.
- Cockpit & Deck
- Hardware, Fasteners
- Camouflage
- Misc.
- Comm.

Marpac Macerator Pump



- Self-priming up to 6' (1.8m).
- Superior performance up to 10 GPM.
- Heavy duty 12 volt motor.
- Direct replacement for Jabsco, Johnson and Shurflo.
- Rotary cutter shreds waste before it is pumped into or out from the holding tank.
- 1-1/2" hose or NPT waste inlet, 1" hose discharge outlet.
- 1 year warranty.

Order No.	Description	List Price	
7-0901	Macerator Pump	\$127.99	G0-5758000

Jabsco Macerator Waste Pump



- Flow rate to 12 GPM.
- Self-priming up to 4'.
- New four-bladed chopper reduces clogging.
- Detects the absence of fluid then shuts off pump before impeller is damaged.
- Sensor provides adequate run-dry period to allow initial priming of the pump.
- Inlet port: 1-1/2" hose barb plus 1-1/2" NPT inlet port.
- Discharge port: 1" hose barb.
- Dimensions: 11-3/8" L x 4-3/4" W x 3-5/8" H.
- Complies with USCG Regulation 183.410 and ISO 8846 MARINE.
- 12 volt.

Order No.	Mfg. No. / Description	List Price	
415154	(18590-2092)	\$240.29	G0-9906100
415162	(18598-1000) Service Kit	\$75.89	G0-5805000

Whale Gulper Grouper Fishbox Mk3 Waste Pump



- Ideal replacement for macerator pumps.
- Long term durability - runs dry without damage.
- Includes 90° port orientation to retrofit in line with existing macerator pumps in compact areas.
- Non-choke valves- easily handle fishbox waste.
- Easy to install - 360 degree head rotation and choice of 1" (25mm) or 1-1/2" (38mm) hose connections.
- Fast pump out - up to 25.5 ltrs (6.75 US gals) per minute.

Order No.	Mfg. No. / Description	List Price	
587505	(BP4772)	\$198.99	F0-9293100

Jabsco Heavy Duty Macerator Pump - 115V AC Voltage



- Flow rate to 14 GPM.
- Self-priming up to 4'.
- Permitting the unit to be mounted above or below the tank in a convenient location.
- Thermal overload protection motor.
- Inlet port: 1-1/2" external pipe thread; Outlet port: 1" ID hose barb.
- Dimensions: 7-15/16" H x 7-1/4" W x 14-13/16" L.
- 115V AC.

Order No.	Mfg. No. / Description	List Price	
415174	(18690-0000)	\$909.09	G0-9090600

Jabsco Waste Pump



- Robust diaphragm pump passes solids and is particularly effective in emptying holding tanks.
- The multi-positional pump head offers a variety of installation options.
- Flow rate to 5 GPM.
- Self-priming up to 10'.
- Capable of extensive dry running.
- Flexible installation.
- Connections for 1-1/2" ID hose.
- Complies with USCG Regulation 183.410 and ISO 8846 MARINE.
- 12 volt.

Order No.	Mfg. No. / Description	List Price	
415136	(50890-1000)	\$359.49	G0-6804200

Whale Gulper Grouper Fishbox Mk2 Waste Pump



- Non-choke valves- easily handle fishbox waste.
- Ideal replacement for macerator pumps.
- Long term durability - runs dry without damage.
- Easy to install - 360° head rotation and choice of 1" or 1-1/2" hose connections to suit your installation needs.
- Fast pump out - up to 6.75 US gals/ 25.5 ltrs per minute.
- Fit in convenient locations - Multi-directional head position.

Order No.	Mfg. No. / Description	List Price	
587500	(BP4672)	\$202.79	F0-5914100

Shurflo Macerator Pump



- Designed specifically for sanitation waste and fish box evacuations.
- Features a premium impeller design with run-dry capability.
- Includes a seamless shell motor with O-ring sealed end bells and a sealed manual turn key.
- Unique dual blade and housing construction ensure problem free pumping, providing superior performance in harsh marine environments.
- Thermally protected and ignition protected.
- 13 GPM flow rate.
- Inlet port: 1-1/2" barb/1-1/2" NPT. Outlet port: 1" barb.
- 12 volt.

Order No.	Mfg. No. / Description	List Price	
353120	(3200-001)	\$209.49	G0-6304100

- Electronics
- Trolling Motors
- Instruments
- Electrical
- Lighting
- Anchor & Dock
- Safety
- Steering, Controls
- Pumps
- Fuel System
- Seating & Pedestals
- Trailering
- Tops & Covers
- Perform.
- Propellers
- Engine & Care
- Cleaning & Care
- Paint & Paint Acc.
- Fun & Flotation
- Topside Acc.
- Cockpit & Deck
- Hardware, Fasteners
- Camouflage
- Misc.
- Comm.

Johnson Pump Viking Power 32 - Shower Drain Bilge & Waste Water Pump

SPXFLOW
Johnson Pump



- Designed to meet the rigorous demands.
- Self priming to about 8.2'.
- Thanks to its single chamber design and non-choke valves, it can be used to pump un-macerated sewage to a holding tank or transfer it onwards to a septic tank.
- The pump cannot only be run dry, it can also handle a mixture of air and water without difficulty.
- Includes a hand crank in case of emergency.
- Connection: 1-1/2".
- 8.5 GPM.
- 12 volt.

Order No.	Mfg. No. / Description	List Price	
461952	(10-13373-03)	\$426.49	G0-5758200

Johnson Pump Viking Power 16 - Shower Drain Bilge & Waste Water Pump

SPXFLOW
Johnson Pump



- A modern, single-chamber self-priming diaphragm pump that can be set up in several different pump/ motor configurations.
- Self priming to about 10'.
- It is easy to install anywhere after the drain outlet in the wastewater system or as a bilge pump.
- Its non-choke valves means that no in-line filters are necessary.
- The pump can be run dry, and handle a mixture of air and water easily.
- The low pulse and muffled rubber bracket offer quiet operation.
- Connection: KlickTite XL connectors for 1" hose or 3/4" hose and 1/2" BSP threads.
- 4.2 GPM.
- 12 volt.

Order No.	Mfg. No. / Description	List Price	
461951	(10-13350-03)	\$255.89	G0-5417100

Johnson Pump Macerator Pumps

SPXFLOW
Johnson Pump



- The TA3P10-19 macerator pump takes care of toilet waste.
- A rotary cutter shreds waste before it is pumped into or out from the holding tank.
- The pump should be connected as close as possible to the holding tank discharge outlet or the bowl discharge outlet.
- 10 GPM.
- Outlet connection: 1" hose.
- Inlet connection: 1-1/2" hose or 1-1/2" NPT.
- Dimensions: 9.06" L x 4.25" W x 3.23" H.
- Note! Use unbleached lavatory paper only.

Order No.	Mfg. No. / Description	List Price	
470170	(10-24453-01) 12 volt	\$174.59	G0-8961100
470174	(10-24453-02) 24 volt	\$198.39	G0-2923100
462329	(09-45595) Service Kit	\$47.59	G0-9813000

Groco 155 Series Waste Macerator Pump

GROCO



- 155 Series waste macerator pumps make fast work (17 GPM) of holding tank pump-out.
- Sizes are available to fit any rigid holding tank (36" maximum depth, 1" inch increments).
- Since waste is macerated BEFORE leaving the tank, smaller hose and overboard seacock (3/4") may be used in the discharge line.
- Tank depth: 10".
- 12 volt.
- NOTE: New pump installations require GROCO MP Hardware (tank hardware kit), ordered separately.

Order No.	Mfg. No. / Description	List Price	
377111	(155-6110-12)	\$847.89	G0-9086500

Moeller Waste Tanks

MOELLER
marine products



- A vast array of combo water/waste tank sizes ensures you the right fit for your vessel needs.
- Features nominal wall thickness of 0.30" (7.6mm).
- Provides standard NPT openings for vent, fill and drain.
- Polyethylene tanks will not filter taste into water or emit waste odors.
- Resin meets FDA spec CFT177 1520 requirements.
- Satisfies all U.S. Coast Guard standards.

Order No.	Mfg. No. / Description	List Price	
666961	(041206) 5 Gal. 16" L x 11-3/4" W x 8" H	\$160.49	G0-3570100
666973	(041209) 9 Gal. 17" L x 13-3/4" W x 10-1/4" H	\$167.29	G0-8021100
4810084	(41215) 12 Gal. 24-1/4" L x 15-1/4" W x 8-3/4" H	\$177.59	G0-9981100
667014	(041220) 19 Gal. 21" L x 17" W x 14" H	\$251.39	G0-3486100
4810087	(41225) 25 Gal. 29-1/2" L x 16-5/8" W x 12-3/4" H	\$197.99	G0-5623100
4810088	(41229) 28 Gal. 23-1/2" L x 20" W x 15-1/2" H	\$248.19	H0-1984100
667038	(041230) 30 Gal. 28" L x 23" W x 11-1/2" H	\$294.19	G0-1179100
4810090	(41239) 39 Gal. 32" L x 21-1/2" W (top) 19-3/4" (bottom) x 14-1/2" H	\$240.99	G0-6416100
4810091	(41245) 45 Gal. 35-1/4" L x 20-7/8" W x 15-1/4" H	\$313.29	G0-0990200

PIPE-TO-HOSE KITS

- Contains parts required to attach hoses to tanks: (2) 1/2" NPT; 1/2" barb; (2) 1-1/2" NPT; 1-1/2" barb; (1) 1-1/2" MNPT; 1/2" FNPT reducer, thread sealing tape.

Order No.	Mfg. No. / Description	List Price	
4810092	(41311) Straight Pipe-to-Hose Kit	\$37.09	H0-5222000
4810094	(41390) 90° Pipe-to-Hose Kit	\$42.39	H0-3452000



SPECIAL HANDLING MAY APPLY



Groco Vented Loops

GROCO.

- Allows air to enter to break siphon, but does not permit air and odors to escape!
- Cap is threaded 1/2" NPT to accept a barb fitting if you wish to vent overboard.
- Overboard venting is required, IF used in an exhaust system.
- Mount hardware is included.



Order No.	Mfg. No. / Description	List Price	
377057	(HVL-0750) Hose ID 3/4"	\$216.99	GO-8354100
377069	(HVL-1000) Hose ID 1"	\$218.19	GO-9164100
377071	(HVL-1500) Hose ID 1-1/2"	\$240.59	GO-0216100

Rule Vented Loops

rule
a xylem brand



- For use in bilge pump installations to prevent siphoning of water back into boat from thru hull.
- Features a one-way duckbill valve incorporated in the top of the loop that allows air to enter the line when not in use while effectively sealing as water passes through.

Order No.	Mfg. No. / Description	List Price	
582850	(260) 3/4"	\$71.29	GO-6774000
582862	(261) 1-1/8"	\$80.89	GO-0245000

Forespar Vented Loops for Waste Line

FORESPAR



- Molded from high strength Marelon.
- The simple valve system incorporated in the top of the loop allows air to enter the line when not in use, yet effectively seals as water or other fluid passes through.

Order No.	Mfg. No. / Description	List Price	
353425	(903001) Barb 3/4" 4-1/2" H, 3-3/4" W	\$31.29	GO-6902000
353437	(903000) Barb 1-1/2" 5-1/4" H, 7-3/4" W	\$35.09	GO-1532000

Buck-Algonquin Bronze Vented Loop

BUCK ALGONQUIN



- Complete with joker valve.
- Hose ID 3/4".
- Overall height: 2-1/2".
- Overall width: 2-1/4".

Order No.	Mfg. No. / Description	List Price	
260909	(00VL75)	\$48.79	GO-9623000
260959	(60VL75CV) Replacement Joker Valve	\$13.98	GO-7390000

Jabco Y-Valve

JABSCO
a xylem brand



- Allows waste to be pumped overboard or into a holding tank.
- Rotating ports allow for variable routing of hoses onto the valve.
- Connections for two 1-1/2" ports and 1" inlet port.

Order No.	Mfg. No. / Description	List Price	
415201	(45490-1000)	\$97.59	GO-9356000

Forespar Y-Valve

FORESPAR



- Molded from high strength Marelon.
- The valves are operated by a simple 120° movement.
- Positive stops are provided between positions.
- Barb 1-1/2".

Order No.	Mfg. No. / Description	List Price	
353451	(902000)	\$65.89	GO-5144000

Marpac Nylon Deck Fill

marpac



- Black nylon deck fill.
- Two style caps included: Slotted and finger tighten cap.
- Cap labels also included.
- Designed for use with 1-1/2" hose.

Order No.	Description	List Price	
7-53264	Nylon Deck Fill	\$15.69	HO-1490000

Perko Fig. 1269 Waste Deck Plate for Hose

PERKO
USA



- Chrome plated zinc alloy.
- Black polymer cap.
- Deck plate key and O-ring included.
- Deck plate with cap marked "Waste".
- Uses #8 fasteners.
- Cap has a slot between the holes.
- For hose size: 1-1/2".
- Length of neck: 2-1/2". Flange OD 3-1/4".
- Mounting hole diameter: 2-1/8".

Order No.	Mfg. No. / Description	List Price	
540165	(1269 DPO CHR)	\$43.89	GO-1492000
540166	(1269 DPO 99A) Cap with O-Ring Only	\$13.59	GO-1190000

Perko Fig. 524 Non-Vented Deck Plate for Pipe

PERKO
USA



- Chrome plated cast bronze.
- Deck plate key and O-ring included.
- Uses #8 fasteners.
- Cap has a slot between the holes.
- For pipe size: 1-1/2".
- Flange OD 3-5/8". Mounting hole diameter: 2-3/8".

Order No.	Mfg. No. / Description	List Price	
540155	(0524 DPO CHR)	\$170.79	HO-7420100

- Electronics
- Trolling Motors
- Instruments
- Electrical
- Lighting
- Anchor & Dock
- Safety
- Steering, Controls
- Pumps
- Fuel System
- Seating & Pedestals
- Trailer
- Tops & Covers
- Perform.
- Propellers
- Engine & Care
- Cleaning & Care
- Paint & Paint Acc.
- Fun & Flotation
- Topside Acc.
- Cockpit & Deck
- Hardware, Fasteners
- Camouflage
- Misc.
- Comm.

- Electronics
- Trolling Motors
- Instruments
- Electrical
- Lighting
- Anchor & Dock
- Safety
- Steering, Controls
- Pumps**
- Fuel System
- Seating & Pedestals
- Trailering
- Tops & Covers
- Perform.
- Propellers
- Engine & Care
- Cleaning & Care
- Paint & Paint Acc.
- Fun & Flotation
- Topside Acc.
- Cockpit & Deck
- Hardware, Fasteners
- Camouflage
- Misc.
- Comm.

MPI Products Series 104 Premium Rubber Sanitation Hose (Single Wire)



- Premium heavy duty sanitation hose suitable for all head and holding tank connections.
- Specially compounded rubber provides maximum resistance to odor permeation and toilet chemicals.
- Helical wire construction provides excellent strength and flexibility. Resists heat and ozone.
- Is formulated for maximum resistance to weather, UV and ozone resistant.

Order No.	Mfg. No. / Description	List Price	
771534	(104-1126) 1-1/2" x 50'	\$430.29	HO-7185200

MPI Products Series 148 Premium PVC Sanitation and Water Hose



- FDA approved compounds.
- For use in holding tank connection, sanitation vent and toilet systems.
- Smooth extra heavy duty PVC tube, reinforced with PVC helical rod.
- Made with specially formulated FDA approved material to provide excellent resistance to odor permeation and toilet chemicals.
- Not recommended for use in alcohol, anti-freeze, petrochemical, potable water, solvent or pressurized water systems.

Order No.	Mfg. No. / Description	List Price	
771394	(148-0586) 5/8" x 50'	\$93.59	HO-5165000
771407	(148-0346) 3/4" x 50'	\$101.99	HO-9116000
771419	(148-1006) 1" x 50'	\$118.29	HO-7907000
771421	(148-1186) 1-1/8" x 50'	\$133.89	HO-3308000
771433	(148-1146) 1-1/4" x 50'	\$153.89	HO-3329000
771445	(148-1126) 1-1/2" x 50'	\$165.69	HO-1499000

Thetford Ecosmart Enzyme - Holding Tank Deodorant



- Natural enzymatic deodorizer.
- Quickly breaks down and liquefies waste and tissue to prevent messy clogs.
- Detergent additive keeps tank clean.
- Non-staining orange dye washes clean with soap and water.
- Carries the Terra Choice EcoLogo.

Order No.	Mfg. No. / Description	List Price	
Z03575	(32947) 36 oz.	\$17.49	HO-9401000

MPI Products Series 144 Odor-Guard Premium PVC Sanitation Hose



- Smooth wall extra heavy duty vinyl hose with PVC helical reinforcement.
- Has the same flexibility as our Premium Sanitation Hose.
- Extra odor fighting compound for all head and holding tank connections.
- Not recommended for use in alcohol, anti-freeze, petrochemical, potable water, solvent or pressurized water systems.

Order No.	Mfg. No. / Description	List Price	
771508	(144-1126) 1-1/2" x 50'	\$213.69	HO-1282100

Marpro Instant Fresh Toilet & Holding Tank Treatment



- Heavy duty formula quickly eliminates odors.
- Fresh lemon scent.
- Breaks down waste and tissue paper.
- Formaldehyde free, safe formula.
- Lubricants prevent drain valves from sticking.

Order No.	Description	List Price	
7-2727	8 fl. oz., Sold 4 Pack Only	\$14.19	FO-3990000
7-2728	32 fl. oz.	\$7.89	FO-2550000
7-2729	64 fl. oz.	\$13.99	FO-9790000

Thetford Ecosmart Nitrate - Formaldehyde-Free Formula



- Superior odor control.
- Quickly breaks down and liquefies waste and tissue to prevent messy clogs.
- Detergent additive keeps tanks clean.
- Non-staining green dye washes clean with soap and water.
- Carries the Terra Choice EcoLogo.

Order No.	Mfg. No. / Description	List Price	
M770-2949	(32949) 36 oz.	\$16.49	Z0-2701000

Marpac Mega Rolls Toilet Tissue



- Biodegradable.
- 100% recycled fibers.
- Resealable pouch.
- Dissolves quickly.
- Quality tissue.
- 2 rolls, 500 2-ply bath tissue.
- Dimensions: 4-3/8" x 3-3/4".

Order No.	Description	List Price	
7-2731	Mega Rolls Toilet Tissue	\$6.09	GO-8040000

Camco TastePURE™ Drinking Water Freshener



- Eliminate algae and slime buildup from drinking water tanks.
- Just one ounce for every 20 gallons of water helps remove bad smells and tastes.

Order No. **583701** Mfg. No. / Description (40206) 16 fl. oz. List Price **\$5.79** FO-5040000

AHEAD Sum uh dat™ Bio-Enhancer and Odor Controller



- Enhances the Natural Bio-Degrading Process.
- Increase Bacterial Metabolism by up to 1000%.
- Promotes new bacterial growth.
- Pre-measuring and dispensing bottle.
- Quickly destroys foul odors, not cover them up.
- Effective in fresh and saltwater environments.
- Environmentally friendly.
- 100% biodegradable.

Order No. **242913** Mfg. No. / Description (MSDENH) 32 fl. oz. List Price **\$41.09** EO-2803000

Star Brite Aqua Water Shock



- Instantly removes bad taste or smells from boat or RV's potable water.
- Ideal for use after seasonal storage to "freshen" water tanks.
- Removes chlorine, sulphur, plastic or metal odor and taste.
- Provides long-lasting effect, even in extreme temperatures.
- 1 fluid ounce treats 10 gallons of water.

Order No. **625725** Mfg. No. / Description (097116) 16 fl. oz. List Price **\$13.39** GO-7980000

Chlorine Tablets



Order No. **596088** Mfg. No. / Description (CZ-CLTAB10) 10# List Price **\$125.29** EO-7939000

AHEAD Sum uh dat™ Bio-Activator and Waste Degrader



- Accelerates organic waste degradation.
- Replenishes valuable micro-organisms.
- Serves as microbial food source.
- Keeps system working effectively.
- Reduces odors and solids.
- 100% biodegradable.
- Environmentally friendly.
- Improves biological activity.

Order No. **242911** Mfg. No. / Description (MSDACT) Tub Contains (20) 1 oz. Packets List Price **\$46.89** EO-7153000

Star Brite Aqua Water Treatment & Freshener



- Maintains perfect drinking water quality in boats and RV's.
- Prevents foul tasting or smelling potable water.
- Can be used as often as needed to ensure quality of bathing and drinking water and ice.
- Prevents water from taking on chlorine, sulphur, plastic or metal odor or taste.
- 1 fluid ounce treats 10 gallons of water.

Order No. **625720** Mfg. No. / Description (097008) 8 fl. oz. List Price **\$8.39** GO-2650000
 Order No. **625722** Mfg. No. / Description (097016) 16 fl. oz. List Price **\$13.39** GO-7980000

Man O War Enhancer

Order No. **596090** Mfg. No. / Description (ENH) List Price **\$80.98** EO-4706000

Bacteria Kit

Order No. **596085** Mfg. No. / Description (MANOWAR) List Price **\$136.98** EO-4720100

Formula 101 Bacteria



Order No. **202464** Mfg. No. / Description (5LB PAIL) 5 lb. Pail List Price **\$261.09** HO-5665100

SPECIAL HANDLING MAY APPLY



- Electronics
- Trolling Motors
- Instruments
- Electrical
- Lighting
- Anchor & Dock
- Safety
- Steering, Controls
- Pumps
- Fuel System
- Seating & Pedestals
- Trailer
- Tops & Covers
- Perform.
- Propellers
- Engine & Care
- Cleaning & Care
- Paint & Paint Acc.
- Fun & Flotation
- Topside Acc.
- Cockpit & Deck
- Hardware, Fasteners
- Camouflage
- Misc.
- Comm.

AHEAD Be-Hind Tank

- A fully self-contained automatic water waste discharge system.
- Designed to look just like the AHEAD Tank and connects right behind the AHEAD Tank at the same gravity water flow.
- Comes complete with a Sump Pump, a vertical float switch and a check valve, all inside a durable, lightweight and compact LLPE polyethylene tank.
- Reliable/automatic operation.
- Dimensions: 18" x 18" x 18".
- 110 volt.

Order No.	Mfg. No. / Description	List Price
242909	(WWDS-6) 6/12 Man	\$1,343.29 C0-0814110
242915	(WWDS-12) 12 Man	\$1,343.29 C0-0814110



AHEAD Tank™ Type II Marine Sanitation Devices



242905



242907

- Constructed of LLPE, a durable lightweight corrosion proof polyethylene material. Its three separate sewage treatment chambers are rotationally molded into the internal structure of one signal tank.
- It will not rust nor corrode and it's not affected by harsh chemicals, UV rays or the most extreme environmental conditions.
- Odor free operation.
- Uses fresh or salt water.
- Gravity overboard discharge.
- Includes: Installation & operation manual, Hurricane Linear Air Pump, air hose & hose barb, (4) aluminum orange powder coated mounting brackets, pail of Sumuhdat Bio-Activator & Odor Controller and 10 lb. bucket of Blue Crystal Chlorine Disinfectant Tablets.
- USCG Certified in accordance with USCG Title 33 Code of Federal Regulations (CFR) 159.16, Subpart C, 159.53 (b) Type II, 159.97 Inspected Vessels and approved worldwide in compliance with IMO Resolution MEPC.2 (VI) to meet the operational requirements referred to in Regulation 4/1.1 of Annex IV of the International Convention for the Prevention of Pollution from Ships 1973/78.

AT-6T MARINE SANITATION DEVICE - FLOW RATE: 56 GALLONS

Order No.	Mfg. No.	Dimensions	# of Persons (per 24 hrs.)	List Price
242905	(AT-6T)	42" x 18" x 20"	6 Persons	\$5,258.29 C0-5596440

AT-12T MARINE SANITATION DEVICE - FLOW RATE: 88 GALLONS

Order No.	Mfg. No.	Dimensions	# of Persons (per 24 hrs.)	List Price
242907	(AT-12T)	56" x 23" x 21"	12 Persons	\$7,958.29 C0-5546760

Sea Horse Wastewater Treatment Systems - IMO Series



SPECIAL ORDER ONLY • PRICE ON REQUEST

- Sea Horse has developed its newest units to meet the most recent IMO certified Sewage Treatment Systems regulations (IMO Res. MEPC.115(51), Reg 9.1.1, and 33 CFR 159.015). Those requirements went in to effect on Jan 1, 2010 for new vessels. Since then our customer have enjoyed the trouble free operation of the Sea Horse models they they've come to expect.
- Our units use a 2 HP high-pressure discharge pump, and a media filter with a large surface area, to ensure it maximum life.
- In addition, our control panel removes the guesswork from the operator to insure trouble free operation.
- Our main goal at Sea Horse is to make sure you can operate your vessel without worry from you're your sewage system while still maintaining the highest environmental quality.
- Features and Benefits:
IMO / USCG Certified.
2 HP TEFC High Pressure Pump.
Large surface area filter media for long life.
Custom sizing available.

- Electronics
- Trolling Motors
- Instruments
- Electrical
- Lighting
- Anchor & Dock
- Safety
- Steering, Controls
- Pumps**
- Fuel System
- Seating & Pedestals
- Trailer
- Tops & Covers
- Perform.
- Propellers
- Engine & Care
- Cleaning & Care
- Paint & Paint Acc.
- Fun & Flotation
- Topside Acc.
- Cockpit & Deck
- Hardware, Fasteners
- Camouflage
- Misc.
- Comm.



SPECIAL HANDLING MAY APPLY



Marpac Livewell Pumps - Cartridge Type



- Anti-airlock feature keeps water flowing.
- Removable powerhead design.
- Extended life water cooled motor.
- Lightweight glass resin composite impeller resists breakage.
- Thermoplastic housing resists heat and stress.
- High grade 316 stainless steel shaft.
- Just lift a tab and remove the motor to clean.
- Straight and omni-directional 90° hose barbs.
- Easy installation and easy to clean.
- Quick change motor cartridge replacement (Order No. 7-2218).
- 3/4" OD discharge port. 3/4" Straight thread NPS.

Order No.	Description	List Price	
7-2216	750 GPH, In-line with Standard 3/4" Outlet	\$50.79	GO-3043000
7-2214	750 GPH, 90° Inlets with Standard 3/4" Outlet	\$50.79	GO-3043000
7-2218	Replacement Motor Cartridge	\$33.79	GO-4622000

Rule "C Tournament" Series Livewell/Aerator Pumps

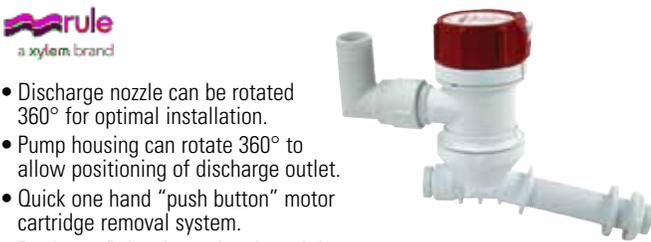

- Discharge nozzle can be rotated 360° for optimal installation.
- Pump housing can rotate 360° to allow positioning of discharge outlet.
- Quick one hand "push button" motor cartridge removal system.
- Dual port fitting for optional washdown pump.
- Angled pick-up with straight thread.

Order No.	Mfg. No. / Description	List Price	
581923	(401C) 500 GPH	\$64.09	GO-4924000
581935	(403C) 800 GPH	\$68.39	GO-2854000
581947	(405C) 1,100 GPH	\$77.89	GO-9125000

Rule "STC Tournament" Series Livewell/Aerator Pumps

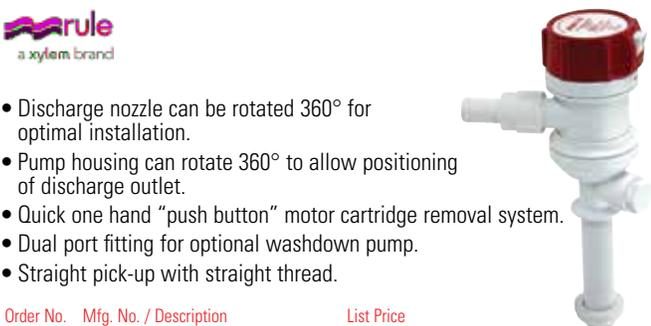

- Discharge nozzle can be rotated 360° for optimal installation.
- Pump housing can rotate 360° to allow positioning of discharge outlet.
- Quick one hand "push button" motor cartridge removal system.
- Dual port fitting for optional washdown pump.
- Straight pick-up with straight thread.

Order No.	Mfg. No. / Description	List Price	
581973	(401STC) 500 GPH	\$64.09	GO-4924000
581985	(403STC) 800 GPH	\$68.69	GO-2064000
581997	(405STC) 1,100 GPH	\$77.89	GO-9125000

Rule Fittings for Livewell/Aerator Pump



Rule Tournament Series Dual Port Livewell Pump

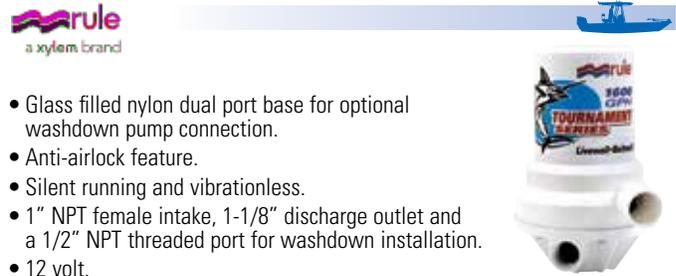

- Glass filled nylon dual port base for optional washdown pump connection.
- Anti-airlock feature.
- Silent running and vibrationless.
- 1" NPT female intake, 1-1/8" discharge outlet and a 1/2" NPT threaded port for washdown installation.
- 12 volt.

Order No.	Mfg. No. / Description	List Price	
581733	(209FDP) 1,600 GPH	\$199.89	GO-3933100

Rule Tournament Series Bronze Base Livewell Pump

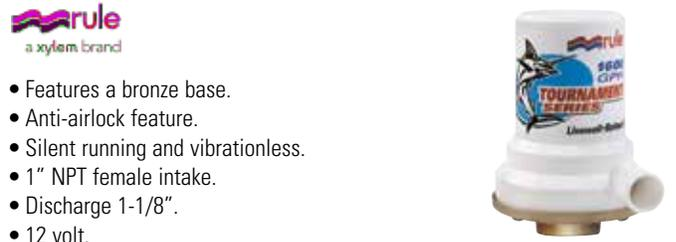

- Features a bronze base.
- Anti-airlock feature.
- Silent running and vibrationless.
- 1" NPT female intake.
- Discharge 1-1/8".
- 12 volt.

Order No.	Mfg. No. / Description	List Price	
581745	(209B) 1,600 GPH	\$210.19	GO-3804100

Rule "FC Tournament" Series Livewell/Aerator Pumps

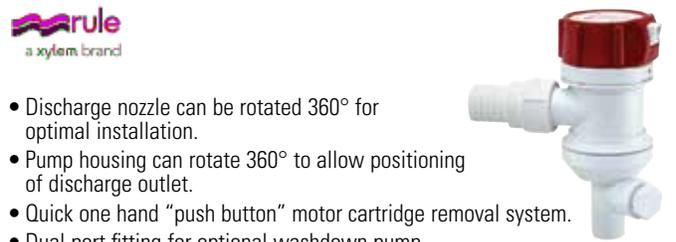

- Discharge nozzle can be rotated 360° for optimal installation.
- Pump housing can rotate 360° to allow positioning of discharge outlet.
- Quick one hand "push button" motor cartridge removal system.
- Dual port fitting for optional washdown pump.
- Tapered thread for seacock application.

Order No.	Mfg. No. / Description	List Price	
581856	(401FC) 500 GPH	\$59.39	GO-9793000
581858	(403FC) 800 GPH	\$62.89	GO-4124000
581872	(405FC) 1,100 GPH	\$67.49	GO-2254000

Rule Replacement Motor Cartridges for Tournament Series



- Quick one hand "push button" motor cartridge removal system.

Order No.	Mfg. No. / Description	List Price	
582088	(45DR) 500 GPH	\$37.99	GO-5452000
582090	(46DR) 800 GPH	\$46.29	GO-1013000
582103	(47DR) 1,100 GPH	\$49.99	GO-9433000

Rule Replacement Motor Cartridges for Original Pro-Series Livewell Pumps



- For all Pro-Series Aerator Pumps.
- Fits older Rule Aerator Pumps. Old Style.

Order No.	Mfg. No. / Description	List Price	
581555	(25DR) 500 GPH	\$36.39	GO-8342000
581567	(20RR) 700 GPH	\$51.69	GO-3643000
581579	(27DR) 1,100 GPH	\$58.49	GO-9193000

- Electronics
- Trolling Motors
- Instruments
- Electrical
- Lighting
- Anchor & Dock
- Safety
- Steering, Controls
- Pumps
- Fuel System
- Seating & Pedestals
- Trailer
- Tops & Covers
- Perform.
- Propellers
- Engine & Care
- Cleaning & Care
- Paint & Paint Acc.
- Fun & Flotation
- Topside Acc.
- Cockpit & Deck
- Hardware, Fasteners
- Camouflage
- Misc.
- Comm.

Boater Sports Dual Mount Livewell Pump



- Cartridge design means simplified maintenance and unmatched safety when out on the water.
- Cartridge easily exchanges between bilge pumps or live well pumps in case of pump failure.
- High impact, fully sealed construction.

Order No.	Mfg. No. / Description	List Price
1-57442	(57442) 800 GPH	\$33.19 HO-1991000
1-57433	(57433) Replacement Cartridge	\$26.59 HO-5951000

Attwood Tsunami Series Cartridge Aerator Pumps



- With their innovative engineering and compact design, Tsunami pumps deliver high output from a small package.
- Cooler-running motors, premium materials, watertight seals and waterproof wiring.
- Cartridges are replaceable and interchangeable between bilge and aerator pumps.
- 12 volt.

Order No.	Mfg. No.	Threaded	List Price
2350082	(4643-7) 500 GPH	3/4" With 3/4" Seacock	\$39.99 F0-9972000
2350084	(4653-7) 800 GPH	3/4" With 3/4" Seacock	\$45.89 F0-2123000

INCLUDES OUTLET HOSE FITTING

- Includes outlet hose fitting to suit a variety of applications and hose routes. Mounts through hull or remote locations.

Order No.	Mfg. No.	Threaded	List Price
236326	(4640-7) 500 GPH	3/4"	\$36.19 F0-3352000
236348	(4650-7) 800 GPH	3/4"	\$44.89 F0-2413000
236350	(4660-7) 1,200 GPH	1-1/8"	\$56.79 F0-5793000

REPLACEMENT MOTOR CARTRIDGES AND 90° CONNECTOR

Order No.	Mfg. No.	Threaded	List Price
236060	(4620-6) Repl. Motor Cartridge for 500 GPH		\$21.09 F0-6741000
236079	(4622-6) Repl. Motor Cartridge for 800 GPH		\$31.29 F0-0912000
236081	(4624-6) Repl. Motor Cartridge for 1,200 GPH		\$43.89 F0-2703000
2350199	(3890-3) 90° Hose-to-Bar Conn. - For 3/4"-14 Threads		\$6.79 F0-5740000

Shurflo Bait Sentry™ Livewell Pumps



Order No.	Mfg. No.	Outlet	For Tank Size	List Price
353114	(1700-001-030) 500 GPH	3/4"	30 Gallons	\$114.19 G0-1567000
353116	(1700-011-030) 800 GPH	3/4"	40 Gallons	\$122.59 G0-4128000
353117	(1700-021-030) 1,100 GPH	1-1/8"	50 Gallons	\$133.19 G0-4298000

Boater Sports Dual Mount Livewell Pump



- 800 GPH thru-hull, submersible livewell pump with 3/4" hose outlet.
- Straight or angled mount.
- 30" marine-grade tinned lead wires.
- Salt or freshwater.
- 12 volt.

Order No.	Mfg. No. / Description	List Price
1-57473	(57473)	\$37.29 HO-7322000

Shurflo Piranha™ Straight Port Livewell Pumps



- High density nylon housing.
- Heavy duty water cooled motor.
- Anti-airlock. Submersible.
- Removable cartridge for easy cleaning.
- Includes 6' tinned wire assembly.
- 3/4" inlet.
- Dimensions: 9-1/2" x 3-3/4".
- 12 volt.

Order No.	Mfg. No.	Discharge	List Price
353110	(357-012-10) 600 GPH	3/4"	\$55.29 G0-4073000
353112	(357-112-10) 800 GPH	3/4"	\$58.69 G0-2393000
353113	(357-102-10) 1,100 GPH	1-1/8"	\$64.79 G0-1434000
375195	(94-619-00) Repl. Cartridge for 600 GPH		\$30.89 G0-0702000
375200	(94-620-00) Repl. Cartridge for 800 & 1,100 GPH		\$51.99 G0-3843000

Shurflo Piranha™ Dual Port Livewell Pumps



- Tough nylon housing.
- Washdown port built-in.
- Anti-airlock.
- Removable cartridge for easy cleaning.
- Ignition protected.
- Includes 6' tinned wire assembly.
- 3/4" inlet.
- Dimensions: 6-1/2" x 3-3/4".
- 12 volt.

Order No.	Mfg. No.	Discharge	List Price
353104	(357-113-10) 800 GPH	3/4"	\$58.69 G0-2393000
353103	(357-103-10) 1,100 GPH	1-1/8"	\$64.79 G0-1434000
375200	(94-620-00) Replacement Cartridge		\$51.99 G0-3843000

- Electronics
- Trolling Motors
- Instruments
- Electrical
- Lighting
- Anchor & Dock
- Safety
- Steering, Controls
- Pumps**
- Fuel System
- Seating & Pedestals
- Trailer
- Tops & Covers
- Perform.
- Propellers
- Engine & Care
- Cleaning & Care
- Paint & Paint Acc.
- Fun & Flotation
- Topside Acc.
- Cockpit & Deck
- Hardware, Fasteners
- Camouflage
- Misc.
- Comm.

Johnson Pump Twin Port Aerator/Livewell Pumps

SPXFLOW
 > Johnson Pump



- Twin port pumps offer the convenience of using only the one intake for both the livewell and raw water washdown pump.
- The 3/4" tapered inlet connects directly to the seacock and the upper outlet port provides a continuous flow of water through the 3/4" discharge to the livewell while the lower outlet port connects to the washdown pump through either a 1/2" or 3/4" ports.
- New high pressure inlet seal easily handles the higher pressures created by high speed pickups commonly used.
- Note can also keep in the plug on second port and use as aerator for tight applications that can use NPT thread.
- Made in the USA.
- 12 volt.

Order No.	Mfg. No. / Description	List Price
470162	(48503) 500 GPH	\$55.49 GO-8173000
470839	(48703) 750 GPH	\$59.79 GO-6004000
470729	(48903) 1,000 GPH	\$63.99 GO-7824000

SPARE MOTOR CARTRIDGE

Order No.	Mfg. No. / Description	List Price
470740	(28552) For 500 GPH	\$25.59 GO-5171000
470738	(28572) For 750 GPH	\$35.29 GO-4632000
470726	(28512) For 1,000 GPH	\$44.79 GO-1003000

Johnson Pump Pro Series Livewell/Baitwell Pump

SPXFLOW
 > Johnson Pump



- Features heavy duty bronze bottom inlet, dual port capability, mega torque motor, double ball bearings, quiet running design, 1" NPT female intake.
- Built for the serious fisherman!
- Connection: 1-1/8" and 1-1/4".
- 12 volt.

Order No.	Mfg. No. / Description	List Price
470700	(16004B) 1,600 GPH	\$187.69 GO-5752100

Johnson Pump Livewell Timer

SPXFLOW
 > Johnson Pump



- Livewell timer will turn on or cycle your aerator to increase the life of pump motor.
- On cycle pumps for 30 seconds, off cycle is variable from 0 to 5 1/2 minutes.
- Allows for continuous run for filling livewell.
- Keeps bait or fish alive without draining battery down.
- 3 wire installation easily replaces your on-off switch.
- 3/8" mounting hole for dashes up to 1" thick.
- Made in the USA.

Order No.	Mfg. No. / Description	List Price
470746	(61125)	\$63.99 GO-7824000

Johnson Pump Cartridge Aerator Pumps

SPXFLOW
 > Johnson Pump



470699

470719



Spare Motor Cartridge

- Exclusive Anti-airlock feature.
- Quick replace motor cartridge.
- Crack resistant DuraPort fittings.
- 316 Stainless steel shaft .
- Tough thermoplastic housing.
- Extended life water cooled motor.
- Easy installation.
- 3 year warranty.
- Made in the USA.
- 12 volt.

Order No.	Mfg. No. / Description	List Price
470702	(28503) 500 GPH Straight	\$55.49 GO-8173000
470714	(38503) 500 GPH 90°	\$55.49 GO-8173000
470699	(28703) 750 GPH Straight	\$59.79 GO-6004000
470719	(38703) 750 GPH 90°	\$59.79 GO-6004000
470721	(28103-00) 1,000 GPH Straight	\$63.99 GO-7824000
470722	(38103) 1,000 GPH 90°	\$63.99 GO-7824000

SPARE MOTOR CARTRIDGE

Order No.	Mfg. No. / Description	List Price
470740	(28552) For 500 GPH	\$25.59 GO-5171000
470738	(28572) For 750 GPH	\$35.29 GO-4632000
470726	(28512) For 1,000 GPH	\$44.79 GO-1003000

Johnson Pump Mounting Bracket

SPXFLOW
 > Johnson Pump



- Gives opportunity to mount the pump on a wall.
- Suitable for Cartridge and Cartridge Duo.
- 90° side mount bracket.

Order No.	Mfg. No. / Description	List Price
470744	(10605-00)	\$13.39 GO-7980000

- Electronics
- Trolling Motors
- Instruments
- Electrical
- Lighting
- Anchor & Dock
- Safety
- Steering, Controls
- Pumps
- Fuel System
- Seating & Pedestals
- Trailering
- Tops & Covers
- Perform.
- Propellers
- Engine & Care
- Cleaning & Care
- Paint & Paint Acc.
- Fun & Flotation
- Topside Acc.
- Cockpit & Deck
- Hardware, Fasteners
- Camouflage
- Misc.
- Comm.

Boater Sports Telescopic Bucket Aerator Pump



- 12 volt aerator pump designed for use in bait buckets or ice chests.
- Adjustable spray head, suction cups and battery clips included.

Order No.	Mfg. No. / Description	List Price
1-57102	(57102)	\$41.29 HO-7742000

Attwood Tsunami RECIRQ Aerator Kit



- Recirculates livewell water to keep it cooler and rich in oxygen.
- Add this kit to any tank that already has freshwater fill system or use as backup pump for a fail-safe system.
- Recirq kit includes: (1) 500 GPH Tsunami aerator pump with short inlet, threaded outlet, (1) 4125-1 aerator spray head, (1) 4232-1 stainless steel strainer, (1) two plastic hose clamps, (1) 3/4" diameter 23" poly hose and (1) straight thread-to-barb connector.

Order No.	Mfg. No. / Description	List Price
2350068	(4253-7)	\$53.49 FO-4473000

Jabco Fish Box Evacuation Pump



- Perfect for emptying a fish box after a day's fishing.
- Self-priming up to 10'.
- Capable of extensive dry running.
- 360° rotating head for flexible installation.
- Connections for 1-1/2" and 1" ID hose.
- 12 volt.

Order No.	Mfg. No. / Description	List Price
414831	(50900-1000) 5 GPM	\$374.19 GO-1705200

Johnson Pump Aqua Jet WPS - Baitwell Pumps

2.4 GPM

- Connection: 3/8" NPT/hose 1/2", 1/2" - 14 NPSM.

Order No.	Mfg. No. / Description	List Price
461955	(10-24677-03)	\$138.59 GO-6829000

3.5 GPM

- Connection: 3/8" NPT/hose 1/2", 1/2" NPT/hose 3/4", 1/2" NPT, 3/4" hose.

Order No.	Mfg. No. / Description	List Price
470734	(1013252103BW)	\$182.39 GO-0222100

Rule Portable Aerator Kit



- Aerates from 5 to 30 gallons of water.
- Attaches easily with suction cups to any non-porous surface.
- 9" long spray tube can be custom cut to fit into any container.
- A fully adjustable spray head increases or reduces flow of water.
- Foam filtration system keeps water sparkling clean.
- The kit also includes battery clips for easy attachment to your 12 volt power source.
- 12 volt.

Order No.	Mfg. No. / Description	List Price
581896	(202K) 460 GPH	\$61.19 GO-0014000

Marpac Baitwell Pump



- Hi capacity pump delivers 5.2 GPM for superior performance.
- Rated continuous for up to 20 minutes.
- Five chamber diaphragm pump that provides superior pressure.
- Strainer uses port connection for simple installation on inlet. (This makes it possible to remove entire unit for a thorough cleaning whenever it is most convenient.)
- Strainer features a transparent cover for simple inspection.
- Easy push-in connections include 3/4" ID threaded, straight and 90° hose barbs to make rigging simple.
- 12 volt. 3 year warranty. CE certified.

Order No.	Description	List Price
7-0439	Baitwell Pump	\$229.59 GO-3835100

Shurflo Pro Baitmaster II Livewell/Washdown Pump



- For continuous duty livewell or washdown applications in harsh environments.
- Seamless motor.
- Run dry capability. Continuous duty.
- Self-priming up to 6'.
- Thermally protected and ignition protected. Sealed switch.
- Shut-off pressure: 45 PSI (3.1 bar).
- 12 volt.

Order No.	Mfg. No. / Description	List Price
353184	(4648-153-E07) 4.0 GPM	\$332.29 GO-3622200



- Designed for self priming water transfer to keep bait alive and active.
- 5 chamber pump head design for long life and quiet operation.
- 12 volt.

- Electronics
- Trolling Motors
- Instruments
- Electrical
- Lighting
- Anchor & Dock
- Safety
- Steering, Controls
- Pumps**
- Fuel System
- Seating & Pedestals
- Trailering
- Tops & Covers
- Perform.
- Propellers
- Engine & Care
- Cleaning & Care
- Paint & Paint Acc.
- Fun & Flotation
- Topside Acc.
- Cockpit & Deck
- Hardware, Fasteners
- Camouflage
- Misc.
- Comm.

- Electronics
- Trolling Motors
- Instruments
- Electrical
- Lighting
- Anchor & Dock
- Safety
- Steering, Controls
- Pumps**
- Fuel System
- Seating & Pedestals
- Trailer
- Tops & Covers
- Perform.
- Propellers
- Engine & Care
- Cleaning & Care
- Paint & Paint Acc.
- Fun & Flotation
- Topside Acc.
- Cockpit & Deck
- Hardware, Fasteners
- Camouflage
- Misc.
- Comm.

Flow-Rite Controls V1 "Open/Closed" Valve



- Remote drain control for any boat's livewell, baitwell or cooler.
- Non-directional for easy insertion into any 3/4" drain line.
- Features dual positive seals when closed and an unobstructed straight through opening when in the "Open" position.

Order No.	Mfg. No. / Description	List Price
2000630	(MPV-01-FN01)	\$44.49

ACTUATOR - SYSTEM 1 "OPEN/CLOSED"

Order No.	Mfg. No. / Description	List Price
2000627	(MPC-1-01-100)	\$24.49

Flow-Rite Controls V2 "Empty/Auto" Valves



2000628



- Reversible check valve that allows a single pump to not only perform the basic livewell functions necessary to keep the catch alive, but does it in a passive or automatic manner.
- By mounting the pump to the valve body, the operator only has to decide whether he wants his livewell functioning or empty.
- When the first fish is caught, place the valve in the "Auto" position and turn on the pump. When the boat is off plane the pump will recirculate and aerate the livewell water and simultaneously blend in a portion of fresh lake water. Used livewell water is expelled out the overflow as fresh water enters to prevent any ammonia build up.
- To empty, simply turn off the pump and move the valve to the "Empty" position for gravity draining.

Order No.	Mfg. No.	Cable Approach	Connection Type	List Price
2000632	(MPV-02-FN01)	Front	Barb	\$50.09
2000634	(MPV-02-RN01)	Rear	Barb	\$50.09

ACTUATOR - SYSTEM 2 "EMPTY/AUTO"

Order No.	Mfg. No. / Description	List Price
2000628	(MPC-1-02-100)	\$23.69

Flow-Rite Controls V3 "Recirc/Empty/Auto" Valves



2000629



- Reversible check valve that allows a single pump to not only perform the basic livewell functions necessary to keep the catch alive, but does it in a passive or automatic manner.
- By mounting the pump to the valve body, the operator only has to decide whether he wants his livewell functioning or empty.
- When the first fish is caught, place the valve in the "Auto" position and turn on the pump. When the boat is off plane the pump will recirculate and aerate the livewell water and simultaneously blend in a portion of fresh lake water. Used livewell water is expelled out the overflow as fresh water enters to prevent any ammonia build up.
- To empty, simply turn off the pump and move the valve to the "Empty" position for gravity draining.
- It also has a third closed "Recirc" position.

Order No.	Mfg. No.	Cable Approach	Connection Type	List Price
2000636	(MPV-03-FN01)	Front	Barb	\$52.09
2000638	(MPV-03-RN01)	Rear	Barb	\$52.09

ACTUATOR - SYSTEM 3 "RECIRC/EMPTY/AUTO"

Order No.	Mfg. No. / Description	List Price
2000629	(MPC-1-03-100)	\$24.49

Flow-Rite Controls Livewell ProTimers



- ProTimer automatically turns your pump on and off for desired circulation and aeration.
- Set to the desired interval and concentrate on fishing.
- ProTimer conserves battery life, is easy to install and easy to operate.
- Adjustable time between 1 runs of 1 to 12 minutes.
- For use with any livewell recirculation pump or Flow-Rite valve system with "Recirc" mode.
- Automatic operation increases fishing time.
- Ideal for tournament fishing.
- Adjustable time delay feature to meet specific ambient conditions.
- Helps to increase battery life.
- Color coding promotes ease of proper operation.
- Helps keep fish healthy and stress free.
- Self-adhesive backing for easy installation; eliminates mounting screws.
- Weather resistant Poly coated circuit board.
- Instructions included.

Order No.	Mfg. No.	List Price
7000396	(MP-103)	\$58.29

PRO TIMER PLUS+

- ProTimer Plus+ has all the features of ProTimer, plus it comes with a master control switch to control on, off or timed livewell operation.

Order No.	Mfg. No.	List Price
7000398	(MP-104)	\$94.79



Flow-Rite Controls Livewell Valve Repair Kit

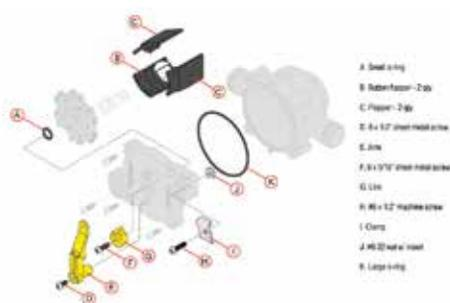

- A. Seal o-ring
- B. Rubber foot - 2/32"
- C. Flapper - 2/32"
- D. 3/4 x 1/2" inner metal arm
- E. Arm
- F. 3/4 x 1/2" inner metal arm
- G. Liner
- H. #6 x 1/2" machine screw
- I. O-ring
- J. #6-32 metric nut
- K. Large o-ring

- Repair kit does not include old style arms or system one arms.

Order No.	Mfg. No.	List Price
7000400	(MPA-060)	\$16.69

Flow-Rite Controls Actuator Upgrade Adapter



- This adapter plate and cover allows boats equipped with a competitive system, utilizing a 2-1/16" hole, to be upgraded to a Flow-Rite premium system.
- The normal hole saw size required for installation of the Flow-Rite premium actuator is 1-3/4".
- Requires (3) three MD-086 screws and (2) MD-093 for actuator installation (not included).

Order No.	Mfg. No.	List Price
7000394	(MA-010)	\$4.39

Leisure Electronics Livewell Aerator Timer Toggle Switch



- 3 position switch automatically cycles pump "On" for 30 seconds every 3 minutes.
- Or select continuous "Run" mode.
- 10 amp capacity, can run multiple pumps.

Order No.	Mfg. No. / Description	List Price
2001071	(LWS-T)	\$49.89

Leisure Electronics Livewell Aerator Timer Module



- Cycles "On" for 30 seconds every 3.5 minutes.
- Use with your existing rocker or toggle switch.
- Epoxy encapsulated waterproof module.
- 10 amp capacity, can run multiple pumps.

Order No.	Mfg. No. / Description	List Price
2001070	(LWS-M)	\$44.39

Flow-Rite Controls Flappers



- Dimensions: 1-3/8" x 7/8".

Order No.	Mfg. No. / Description	List Price
2000624	(MA-001) Regular Flapper without Button	\$2.49
2000625	(MA-002) Button Flapper with Button	\$4.19

Flow-Rite Controls Control Cables



- Each cable includes the brass attachment nut and quick disconnect locking retainer for attachment to the actuator.
- Features a stainless steel control wire for fresh or salt water use.

Order No.	Mfg. No. / Description	List Price
2000623	(MPA-CBL-08) Length 8'	\$16.89
2000620	(MPA-CBL-10) Length 10'	\$19.09
2000621	(MPA-CBL-12) Length 12'	\$20.79
2000622	(C17) Length 17'	\$27.79

Leisure Electronics Variable Livewell Aerator Timer



- Runs pump for 30 seconds.
- Off cycle is variable from 3 seconds to 5 minutes.
- Extra-long threaded brass shaft is adjustable for panels up to 5/8" thick.
- 10 amp capacity, can run multiple pumps.

Order No.	Mfg. No. / Description	List Price
2001072	(LWS-V)	\$49.89

Livewell Control Center



- Solid state livewell timer with a 1 minute run cycle and a variable off cycle of 1 to 15 minutes.
- Has a manual on/off.
- Comes fully wired.
- Face dimensions: 3" tall x 4-1/2" wide.

Order No.	Mfg. No. / Description	List Price
2000073	(752-ATEN246T) Repl. Timer - 4 Terminal	\$38.99
2000076	(VTB-1) Square Replacement Timer	\$45.09

- Electronics
- Trolling Motors
- Instruments
- Electrical
- Lighting
- Anchor & Dock
- Safety
- Steering, Controls
- Pumps
- Fuel System
- Seating & Pedestals
- Trailer
- Tops & Covers
- Perform.
- Propellers
- Engine & Care
- Cleaning & Care
- Paint & Paint Acc.
- Fun & Flotation
- Topside Acc.
- Cockpit & Deck
- Hardware, Fasteners
- Camouflage
- Misc.
- Comm.

T-H Marine The Oxygenator® - Livewell Oxygen Generator



- The Oxygenator Pro Live Well Flush Mount is a livewell oxygen generator that will retrofit most boat live wells from 10 to 20 gallons and operates off the existing boat battery.
- Manufactures 100% pure oxygen by splitting the hydrogen molecule from the oxygen molecule in water. This creates a super saturated oxygen environment, even in the warmest water.
- Power requirement: 12 volt drawing less than 1 amp.
- No switch required - automatically activated when livewell fills with water.
- Emitter size 3-3/8" in diameter.
- Rated capacity 10-20 gallons.

Order No.	Mfg. No. / Description	List Price
7001716	(O2-BK3-DP)	\$193.09 H0-5851100

T-H Marine Max-Air™ Livewell Venturi Aerator



- The venturi system draws fresh air from outside the livewell and injects tiny air bubbles into the water flowing into the livewell.
- The reduced restriction of this fitting allows more water to flow from the pump than traditional spray heads.
- The face plate inlet can be mounted anywhere above the waterline.
- Fits 3/4" hose.
- Includes: Venturi fitting with face plate and 6' tubing.

Order No.	Mfg. No. / Description	List Price
641527	(MAV-2KT-DP)	\$22.89 H0-3731000

T-H Marine Automatic Aerator Control - 10 amp



- Turns pumps on and off automatically.
- Fully adjustable timer.
- 10 amp fully waterproof circuitry.
- Handles high capacity pump current draw.
- Requires a 3" diameter round hole or a 2-1/2" square hole for mounting.
- Auto Spray (On) Time - Approximately 45 Seconds.
- Auto Delay (Off) Time - 1 minute to 10 minutes (maximum).
- Front panel is 3-1/4" x 3-1/4" and requires only 3" behind panel.

Order No.	Mfg. No. / Description	List Price
641678	(AAC-1-DP)	\$96.59 H0-5975000

T-H Marine Pro-Air System® - Livewell Aeration



- Provides long lasting oxygen rich air.
- Easy mount for fixed or portable tanks.
- Dual outlets can aerate two livewells at once.
- Pump capacity - aerates approximately 30 gallons.
- Comes complete with pump, two air stone mounts, two air stones, switch panel and 20 feet of air line tubing.
- 12 volt pump is potted and waterproof.

Order No.	Mfg. No. / Description	List Price
641503	(PAS-1-DP) Complete Kit with Air Stones	\$136.99 H0-9128000
641504	(PAP-1-DP) Pump Only	\$111.09 H0-5666000

T-H Marine EZ Pump™ Advanced Water Pick-Up Systems



- Provides water to aerator pump pickup while underway.
- UV stable and rust resistant.
- Mounts over pump intake.
- Prevents livewell system air lock.
- Screen and pick-up all in one.
- Easy installation - no drilling or running hoses.
- Intake: 1" to 3-1/2".

Order No.	Mfg. No.	Length	Size	Color	List Price
247608	(EZWHT-2-DP)	3-3/8"	Medium	White	\$23.59 H0-5141000
247617	(EZ-BLK-1-DP)	4-3/4"	Long	Black	\$23.59 H0-5141000
247619	(EZ-WHT-1-DP)	4-3/4"	Long	White	\$23.59 H0-5141000

Rule Variable Flow Control Valve



- The Variable Flow Control Valve allows increases and decreases of flow with no damage at all to the pump.
- Range includes fully open flow to zero flow.
- For use with 3/4" hose.

Order No.	Mfg. No. / Description	List Price
581618	(75)	\$18.89 G0-6621000

T-H Marine Bait Tank Plumbing Kit



- Complete kit for plumbing fixed or portable tanks.
- The kit contains the following products:
 - 641388** (ODT-190) 90° overflow drain tube - 12"
 - 6400298** (TH-1202-B) 1-1/8" thru-hull drain fitting
 - 641540** (AHV-2) Aerator spray head for current (DAH-90) Directional aerator head for current creation
 - 641375** (TEE-3/4) Tee fitting to connect both heads to pump

Order No.	Mfg. No. / Description	List Price
236388	(BWK-2-DP)	\$36.09 HO-5612000

Attwood Adjustable Spray Aerator Heads



- Polypropylene construction.
- Use on livewells that have built-in overflows or recirculating systems.
- Mounts on side of tank.
- 90° fitting for installation in tight spaces.
- Rotating head with O-ring adjusts and maintains flow setting.
- Removable head has an interference-fit thread design that will not allow it to vibrate or blow out.
- Can be installed on tanks with up to 5/8" wall thickness.
- Hose ID 3/4".

Order No.	Mfg. No. / Description	List Price
2350200	(4123-1) With Male Conn. f/Flow-Rite Quick-Lok Coupler 3	\$5.99 FO-9140000
2350201	(4125-7)	\$9.19 FO-3460000

T-H Marine Directional Flow Aerator Heads with Fitting



- Great for saltwater baitwells.
- Creates circular current.
- 90° head mounts below waterline to create a strong directional flow.
- Maximum wall thickness: 5/8".

Order No.	Mfg. No.	Hose Diameter	List Price
641589	(DAHIK-750-DP)	3/4"	\$10.49 HO-9260000
641591	(DAHIK-118-DP)	1-1/8"	\$10.49 HO-9260000

T-H Marine Aerator Spray Heads



- Sprays aerated water into livewells.
- Keeps catch and bait fish alive.
- Includes shut-off valve.
- Hose ID 3/4".
- Mounting hole diameter 1-1/16".

FIXED FLANGE						
Order No.	Mfg. No.	Thread Length	Color	Nozzle	List Price	
641540	(AHV-1DP)	3/8"	Black	Straight	\$13.29	HO-7970000
641553	(AHV-92-DP)	5/8"	White	90°	\$9.49	HO-9650000

SCREW ON VALVE						
Order No.	Mfg. No.	Thread Length	Color	Nozzle	List Price	
640108	(AHV-90DP)	3/4"	Black	90°	\$13.29	HO-7970000

Johnson Pump Aerating Heads

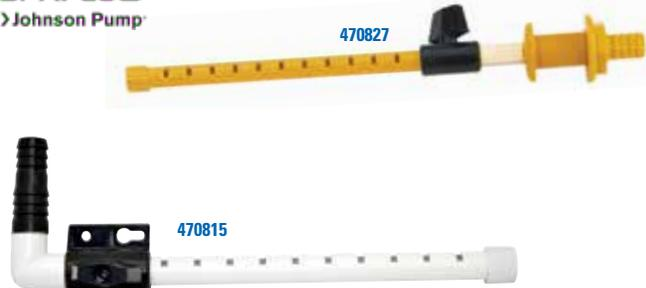

OVERALL LENGTH 13-3/4" THRU-HULL. ONE SHUT OFF VALVE		
Order No.	Mfg. No. / Description	List Price
470827	(90191-00)	\$25.59 GO-5171000

OVERALL LENGTH 10-1/2", 3/4" BARB. ONE SHUT OFF VALVE		
Order No.	Mfg. No. / Description	List Price
470815	(90681-00) With Bracket	\$23.49 GO-4751000

Rule Oxygenator Spray Head



- Rule's Oxygenator Spray Head sprays streams of water back into the livewell tank, enriching the water with oxygen.
- Adjustable spray head allows you to increase or decrease flow of water.
- For use with 3/4" hose.

Order No.	Mfg. No. / Description	List Price
581606	(78)	\$19.69 GO-9131000

- Electronics
- Trolling Motors
- Instruments
- Electrical
- Lighting
- Anchor & Dock
- Safety
- Steering, Controls
- Pumps
- Fuel System
- Seating & Pedestals
- Trailering
- Tops & Covers
- Perform.
- Propellers
- Engine & Care
- Cleaning & Care
- Paint & Paint Acc.
- Fun & Flotation
- Topside Acc.
- Cockpit & Deck
- Hardware, Fasteners
- Camouflage
- Misc.
- Comm.

Marpac Stainless Steel Wire Mesh Strainer



- This screw-on strainers are made from formed stainless steel wire mesh cloth and then molded into a PVC base with internal threads.
- Black base with 3/4" female threads.
- Packaged for display.

Order No.	Description	List Price
7-57075	Mesh Strainer	\$5.69

Rule Livewell Pump Debris Strainer



- The Livewell Pump Debris Strainer attaches directly to any pickup tubes on Rule Livewell Pumps.
- Filters out trash and debris which could clog pump.
- Stainless steel wire mesh, 3/4" female NPSM threads.

Order No.	Mfg. No. / Description	List Price
581581	(73)	\$18.99

T-H Marine Aerator Stainless Steel Wire Mesh Strainers



- Designed to provide effective, dependable protection against trash or fish scales which could clog drains in bait wells or pump impellers in aeration systems.
- Made from formed stainless steel wire mesh cloth and then molded into a black PVC base with internal threads this unit is non-corrosive, functional and looks extremely good installed on any boat.

FITS AERATOR PUMP INTAKE - 3/4" -14 THREAD

Order No.	Mfg. No. / Description	List Price
641642	(AS-1-DP)	\$11.89

FITS TH-1, 1XL, 90, 92 THRU-HULLS - 1" -8 THREAD

Order No.	Mfg. No. / Description	List Price
640088	(AS-2DP)	\$12.39

T-H Marine Thru-Hull Strainer Mount



- Designed to enable a 3/4" thru-hull passage thru a transom or livewell wall and to attach an aerator screen on the other side.
- Flange allows flush fit.
- No outside nut required.
- Threaded length: 1-3/4", overall length 4".
- Includes: Thru-hull (THSM-1) and 641642 (AS-1) wire mesh strainer.
- Fits 3/4" hose.

Order No.	Mfg. No. / Description	List Price
641869	(THSM-1KIT-DP)	\$15.29

T-H Marine Aerator Filters



- Made of black poly material.
- Protects pumps from debris.
- Screws on over pump intake fitting.

AERATOR FILTER

Order No.	Mfg. No. / Description	List Price
641604	(AF-1-DP) Fits 3/4" or 1-1/8"	\$7.19

AERATOR FILTER WITH SNAP-ON MOUNT

- Same as aerator filter above except for mounting.
- Simply install the base mount over aerator pump tube before installing nut, then simply snap aerator filter in place.
- Allows for easier cleaning of filter.

Order No.	Mfg. No. / Description	List Price
6400072	(AFM-1-DP) Fits 3/4"	\$7.49

T-H Marine Aerator Filter Domes



- This attractive, dome-shaped aerator filter protects pumps from any debris in the water.
- The fully curved and perforated surface allows more efficient flow than other molded filters.
- Easy twist-off cleaning.
- Filter mounts onto aerator pump snout or thru-hull fitting.
- This filter can also be used as a screen for overflow drains.
- Fits on standard thru-hulls or pump intakes.

Order No.	Mfg. No.	Hole I.D.	Application	List Price
6400071	(AFD-2-DP)	1"	3/4" Thru-Hull or Pump	\$8.89
6400070	(AFD-118-DP)	1-5/8"	Top of 1-1/2" Thru-Hull	\$9.29

T-H Marine Baitwell Filter with Mount



- Fits over baitwell drains.
- Prevents ingestion of bait fish.
- Mounts behind drain fitting.
- Fits 1-1/2" thru-hull.

Order No.	Mfg. No. / Description	List Price
641680	(BWF-1-DP)	\$9.59

T-H Marine Overflow Drain Tubes - Push-In



- All marine grade PVC construction for long life.
- Tough, flexible vinyl plastic end with a standpipe of white PVC tubing.
- To use simply insert vinyl end into the opening of thru-hull fitting.
- To drain livewell or baitwell, simply remove.

OVERFLOW DRAIN TUBES

Order No.	Mfg. No.	Fits Drain:	Length	List Price
641387	(ODT-1-DP)	1-1/8"	Straight 12"	\$11.19 HO-1760000
641388	(ODT-190-DP)	1-1/8"	90° 12"	\$13.69 HO-1280000

OVERFLOW DRAIN TUBES WITH SCREEN

Order No.	Mfg. No.	Fits Drain:	Length	List Price
641399	(ODT-2-DP)	1-1/2"	Straight 18"	\$30.79 HO-7481000
641438	(ODT-290-DP)	1-1/2"	90° 18"	\$34.19 HO-1502000

FILTER SCREENS

Order No.	Mfg. No. / Description	List Price
641390	(ODTS-2-DP) For ODT-2 and ODT-290	\$6.79 HO-7040000

T-H Marine Livewell Overflow Tube/Utility Storage Clips



- UV stable molded holding clips.
- Mount anywhere to hold items securely.
- Fits ODT-2 - Overflow Drain Tubes or any 1-1/2" tube.
- Sold per pair.

Order No.	Mfg. No. / Description	List Price
237203	(ULC-1-DP) Black	\$6.99 HO-9140000

T-H Marine Overflow Drain Tubes - Screw-In



- All marine grade PVC construction for long life.
- Straight tube.
- These overflow drain tubes feature a threaded end fitting that screws into a threaded thru hull drain. This means of securing the tube assures that the tube will not come out of the fitting in even the roughest conditions. To drain, simply unscrew the tube. A neoprene gasket provides a water tight seal.

OVERFLOW DRAIN TUBE WITH GLUED TOP SCREEN

Order No.	Mfg. No.	Fits Drain:	Length	List Price
641395	(ODT112GSTWDP)	1-1/8"	12"	\$14.89 HO-3980000

OVERFLOW DRAIN TUBE WITH SCREEN

Order No.	Mfg. No.	Fits Drain:	Length	List Price
641400	(ODT-2T)	1-1/2"	18"	\$29.49 HO-9671000

T-H Marine G-Juice® Livewell Treatment and Fish Care Formula



- A single phase, full functional water conditioner for use in fresh and salt water.
- Conditions water entering the livewell, bait tanks, minnow buckets and in fish transport situations.
- Non-toxic to humans, pets and aquatic life.
- Does not contain any salt.
- Removes Nitrites, Ammonia, Chlorine, Chloramines and Heavy Metals.
- Adds Essential Electrolytes.
- Replaces skin slime and stops bleeding.
- Approved for use with THE OXYGENATOR.

FRESHWATER

Order No.	Mfg. No. / Description	List Price
640963	(U28-FW) 8 oz.	\$16.39 HO-3890000
640964	(U216-FW) 16 oz.	\$24.09 HO-5441000

SALTWATER

Order No.	Mfg. No. / Description	List Price
640966	(U264-SW) 64 oz.	\$63.89 HO-3383000

- Electronics
- Trolling Motors
- Instruments
- Electrical
- Lighting
- Anchor & Dock
- Safety
- Steering, Controls
- Pumps
- Fuel System
- Seating & Pedestals
- Trailering
- Tops & Covers
- Perform.
- Propellers
- Engine & Care
- Cleaning & Care
- Paint & Paint Acc.
- Fun & Flotation
- Topside Acc.
- Cockpit & Deck
- Hardware, Fasteners
- Camouflage
- Misc.
- Comm.

T-H Marine G-Force™ Conservation Cull System



LIMITED QUANTITIES

- Straight from the livewell to the balance beam.
- Allows you to handle your fish only once.
- Six numbered buoys.
- Stainless steel hooks.
- Uses a strong plastic clip to hold tight around the lip.
- Aluminum balance beam included.
- Buoy holder for quick & easy storage of each cull float.
- Built-in retainer for stabilizing weight.

Order No. Mfg. No. / Description List Price

T-H Marine G-Force™ Conservation Cull System - Gen 2



- Patent pending.
- Simplified cull clip.
- Stainless steel spring loaded one hand operation.
- Removable floats.
- Color coded line.
- Non-penetrating clip.
- Balance beam included.
- 6 color-coded buoys.
- Allows quicker culling - More fishing time!
- Uses a stronger plastic clip to hold tight around the lip.
- Buoy holder for quick and easy storage of each Cull Ball.

Order No. Mfg. No. / Description List Price
642652 (GFC-CCSG2-DP) **\$58.09** H0-5843000

- Electronics
- Trolling Motors
- Instruments
- Electrical
- Lighting
- Anchor & Dock
- Safety
- Steering, Controls
- Pumps
- Fuel System
- Seating & Pedestals
- Trailer
- Tops & Covers
- Perform.
- Propellers
- Engine & Care
- Cleaning & Care
- Paint & Paint Acc.
- Fun & Flotation
- Topside Acc.
- Cockpit & Deck
- Hardware, Fasteners
- Camouflage
- Misc.
- Comm.