

Catálogo de accesorios Náuticos



Perform.



Propellers



Engine
& Care



Cleaning
& Care



Paint &
Paint Acc.



Fun &
Flotation



Topside
Acc.



Cockpit
& Deck



Hardware,
Fasteners



Camouflage



Misc.



Comm.



Parte 2

2021

El Navegante

www.repuestoselnavegante.com



- Trolling Motors
- Instruments
- Electrical
- Lighting
- Anchor & Dock
- Safety
- Steering, Controls
- Pumps
- Fuel System
- Seating & Pedestals
- Trailer
- Tops & Covers
- Perform.
- Propellers
- Engine & Care
- Cleaning & Care
- Paint & Paint Acc.
- Fun & Flotation
- Topside Acc.
- Cockpit & Deck
- Hardware, Fasteners
- Camouflage
- Misc.
- Comm.

Bienvenidos a Repuestos El Navegante.

Aquí podrás encontrar mas de **35.000** productos de diferentes fabricantes, con una gran variedad de accesorios y componentes para tu embarcación, contamos con mas de 20 años de experiencia en el sector náutico, no dudes en contactarnos para aclarar cualquier duda que tengas, prestamos asesoría técnica lo que es un valor agregado, y te dará tranquilidad a la hora de tomar una decisión de compra.

Nota Importante:

Debido a las restricciones causadas por el Covid 19, y otros problemas a nivel Mundial muchas empresas se vieron afectadas debido a la falta de materia prima, por este motivo tanto los precios como las fechas de entrega sufrieron cambios en gran cantidad de productos, comuníquese con nosotros a través del correo: repuestoselnavegante@gmail.com y solicite su presupuesto sin compromiso, también puede comunicarse vía Telegram o WhatsApp escaneando los códigos QR.

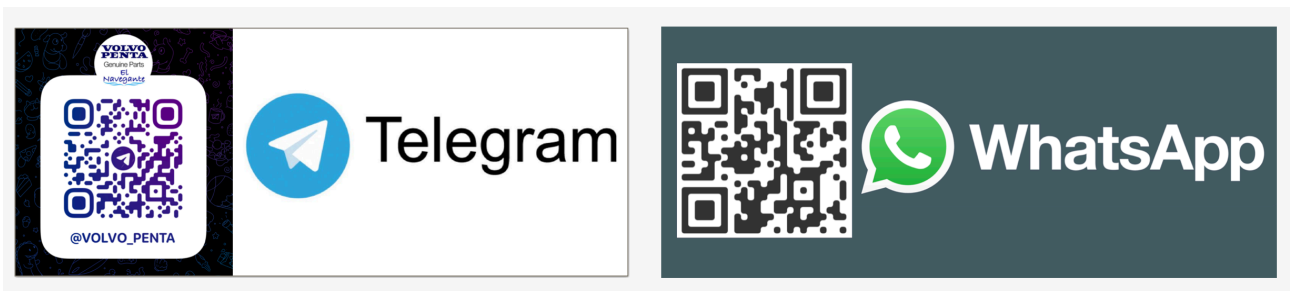

Los productos aquí publicados se encuentran en varias partes del mundo, pero la mayoría se encuentran en Estados Unidos y Europa, por lo que estos precios no incluyen gastos de envío.

También puede consultar en nuestra pagina www.repuestoselnavegante.com nuestros términos y condiciones antes de efectuar la compra, ahí podrá ver también nuestra política de devoluciones.

Los productos pueden ser entregados en un currier de su confianza.

En nuestra pagina podrá encontrar mas de **3.500** productos para entrega inmediata.

Nos especializamos en repuestos Volvo Penta, Cummings, Yanmar, Caterpillar, Mercruiser.

Ofrecemos repuestos para Generadores Onan, Kohler, Westerbeke, Fisher Panda y Northern Lights.



Davis Instruments Vantage Vue® Wireless Weather Station

DAVIS



Sensor suite and console not shown to scale.

- The Davis Vantage Vue weather station combines Davis legendary accuracy and rugged durability into a compact station that's easy to set up and use. Vantage Vue includes a sleek but tough outdoor sensor array and a distinctive LCD console. Its unique Weather Center function provides additional information on each weather variable.
- Station includes: Console, Integrated Sensor Suite including temperature, wind and rain sensors and mounting hardware.

Order No. Mfg. No. / Description
322030 (6250)

List Price
\$562.09 F0-6439300

CONSOLE FEATURES:

- Time & Date: View the current time and date or time of sunrise/sunset.
- Moon Phase: See the eight phases of the moon from new to full.
- Forecast Icons: Icons let you know to expect sun, part sun, clouds, rain or snow.
- Temperature & Humidity: Console updates outside temperature every 10 seconds and inside temperature every minute. In addition, outside humidity updates every 50 seconds and inside humidity every minute.
- Retransmits: Main console can extend range to additional consoles up to 1,000 ft.
- Barometer: Five-position trend arrow shows whether barometric pressure is rising, falling or stable.
- Variable Display Options: See updated variables every 10 seconds for heat index and wind chill to get a better "feel" for the outside environment.
- Rain: Console updates rain totals and rain rate every 20 seconds for the last 25 hours, days, months.
- "Change in Weather Since Yesterday" Feature: Allows comparisons of changes of temperature and barometric pressure from day to day.
- Weather Center: Weather Center provides additional information for each weather variable, such as daily highs and lows, temperature changes by the hour and barometric pressure changes. Also displays astronomical data such as meteor showers.
- User-Friendly Keypad: Domed buttons are easy to sense and press. Glow-in-the-dark keypad buttons give you access to weather information all day and all night. The Done key returns user to "current" screen from anywhere in the program.
- Graphs: Graph the last 25 hours, days or months. View up to 50 graphs including temperature, rain, rain rate, wind and barometric pressure - all on the console.
- "This Time Yesterday" Feature: Data point on the graph indicates the weather during the same time yesterday to help compare and analyze day-to-day weather trends.
- Alarms: Set 22 simultaneous, different alarms to warn of dangers such as high winds, freezing temperatures, rain rate, flood warning and more.
- Wind Speed: See windspeed updates every 2.5 seconds. Displays windspeed in miles per hour, meters per second, kilometers per hour and knots. Provides the average and high wind speed for two-minute and ten-minute intervals.

INTEGRATED SENSOR SUITE (ISS) FEATURES:

- Wireless: Frequency-hopping spread spectrum radio ensures consistent transmission up to 1000 ft. (300 m) from integrated sensor suite to console.
- Rain Collector: Self-emptying tipping spoon measures rain with 0.01" (0.2 mm) resolution.
- Anemometer: Records wind speeds as low as 2 mph (3 km/h) and as high as 180 mph (290 km/h).
- Weather Proof Cover: Corrosion-resistant cover provides durability in extreme conditions. Electronics are potted or over-molded for added moisture shielding.
- Radiation Shield: Provides excellent protection from solar radiation and other sources of radiated and reflected heat.
- Temperature/Relative Humidity: Provides outside temperature readings from -40° to 150° F (-40° to 65° C). Also measures relative humidity from 0 - 100%.
- Easy installation: Installs easy and quickly with included mounting hardware kit.
- Wind Direction: Measures wind direction in compass points or degrees.
- Solar Panel: Energizes the station during the day. On-board super capacitor provides power at night. Lithium battery provides backup when needed.
- Bubble Level: Allows more accurate installation and better data collection.

SPECIFICATIONS:

- Console: Backlit LCD display measures 3" x 4.13". Console dimensions: 7.5" x 5.75" x 4.5". Weighs 1.48 lbs.
- Integrated Sensor Suite (ISS). Dimensions: 12.95" x 5.75" x 13.40". Weighs 5.44 lbs.
- Vantage Vue mounts on top of poles 1" to 1-3/4" in diameter. Pole sold separately. Tripod also available.

Davis Charting Kit



DAVIS

- An excellent gift idea for cruisers and racers alike.
- Includes: One-Arm Protractor, Course Plotter, Protractor Triangle, Parallel Rules, Dividers, pencil and instruction booklet.
- It's all organized in a 5-3/4" x 16-1/4" heavy gauge plastic storage case.

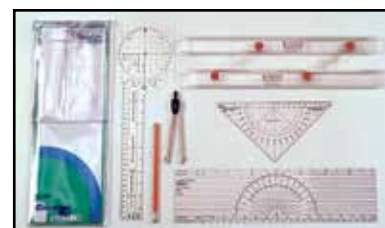

Order No. Mfg. No. / Description
321996 (083)

List Price
\$55.29 F0-0783000

Electronics

Trolling Motors

Instruments

Electrical

Lighting

Anchor & Dock

Safety

Steering, Controls

Pumps

Fuel System

Seating & Pedestals

Trailering

Tops & Covers

Perform.

Propellers

Engine & Care

Cleaning & Care

Paint & Paint Acc.

Fun & Flotation

Topside Acc.

Cockpit & Deck

Hardware, Fasteners

Camouflage

Misc.

Comm.

Davis Instruments Cabled Vantage Pro2™ Weather Station



- Includes: Vantage Pro2 console, integrated sensor suite, mounting hardware, and AC power adapter.
- Integrated sensor suite includes rain collector, temperature and humidity sensors, anemometer, and 40' anemometer cable.
- A 100' cable connects the sensor suite to the console.
- It offers the ultimate in versatility and options for the professional weather observer and the serious weather enthusiast.
- A wide range of options and sensors.
- You'll get your own local forecast, highs and lows, totals or averages, and graphs for virtually all weather variables over the past 24 days, months or years all without using a PC.
- Fast updates every 2.5 seconds (10x faster than the competition).
- Vantage Pro2 is also an excellent choice for emergency professionals, farmers, schools, researchers, municipalities and others to monitor wind and moisture conditions, irrigation requirements, and potential flooding.
- It can be customized with a range of add-on options, such as solar and UV radiation sensors, and soil moisture stations.
- Cabled model is perfect for economical installation or for field installation using our Complete System Shelter.
- No solar power.

VANTAGE PRO2 FEATURES:

- Rainfall measured in 0.01 or 0.2 mm increments.
- Temperature, both inside and outside, currently and for each of the last 24 hours.
- Humidity, both inside and outside, currently and for each of the last 24 hours.
- Wind Speed in 1 mph, 1 knot, 1 km/hr, or 0.1 m/s resolution. Anemometer can be installed separately from rain collector for highest accuracy.
- Wind Direction, both current and dominant, shown on compass rose with 16 points.
- Barometric Pressure given by a five-position trend arrow.
- Current and Historical Data, such as highs and lows, may be viewed for up to 24 days, months or years.
- Forecast displayed in icons for sun, partly cloudy, clouds, rain or snow. 12-hour icon forecast plus 2448 hour ticker tape forecast at bottom of screen.
- Moon Phases in eight stages, from new to full to new.
- Time and Date always on view. Also displays time of sunrise, sunset, time and date of highs and lows.
- Ticker Tape Display provides expanded forecast details and additional information on current conditions.
- Graphing Function shows last 24 hours, days or months of readings or highs and lows. View over 80 graphs, including additional analyses of temperature, rain rate, wind and barometric pressure. Optional WeatherLink software allows even greater analysis.
- Alarms may be set for more than 70 functions.

Order No. **322026** Mfg. No. / Description (6152C) List Price **\$793.19** F0-3255500

Weems & Plath Brass Endurance 125 Barometer



- Maintenance-free, ultra-hard brass finish.
- Beveled glass crystal.
- The Endurance barometers have temperature compensated, fully adjustable aneroid movements with inch and millibar scales.
- Our standard barometer movements are calibrated for altitudes to 3,500' above sea level.
- Dimensions: Dial 4-7/8", base 6", depth 1-5/8".
- Weight: 1.3 lbs.

Order No. **281651** Mfg. No. / Description (530700) List Price **\$196.59** F0-1673100

Weems & Plath Anniversary Barometer



- Forged from solid brass that is hand polished and flawlessly lacquered.
- Highly reliable and accurate double diaphragm German aneroid movement.
- Displays both of the barometric scales; inches of mercury and millibars.
- Movement is temperature compensated and calibrated for altitudes up to 3,500 feet above sea level.
- Dimensions: Dial 5-1/4", base 7", depth 3-1/2".
- Weight: 7 lbs. 2.5 oz.

Order No. **281664** Mfg. No. / Description (100775) List Price **\$984.39** G0-4595600

Weems & Plath Brass Endurance 125 Clock



- Easy-to-read dial, maintenance-free finish and weatherproof construction.
- Beveled glass crystal.
- O-ring seated behind glass for weatherproof construction.
- Dimensions: Dial 4-7/8", base 6", depth 1-5/8".
- Weight: 1.3 lbs.
- AA battery included.

Order No. **281650** Mfg. No. / Description (530500) List Price **\$184.89** F0-2492100

Weems & Plath Anniversary 8-Day Wind Ship's Bell Clock



- Resonates with the rich sound of the traditional ships bell cycle, ringing every half hour.
- Equipped with handcrafted German Hermle 11-jewel, key wound movement with bell silencer and created from solid forged brass that is hand polished and flawlessly lacquered.
- The distinctive dial of the ship bell clock is intricately etched to create a subtle but rich pattern.
- Dimensions: Dial 5-1/4", base: 7", depth: 3-1/2".
- Weight: 8 lbs. 2 oz.

Order No. **281660** Mfg. No. / Description (100275) List Price **\$1,668.09** G0-2671110

- Electronics
- Trolling Motors
- Instruments
- Electrical
- Lighting
- Anchor & Dock
- Safety
- Steering, Controls
- Pumps
- Fuel System
- Seating & Pedestals
- Trailing
- Tops & Covers
- Perform.
- Propellers
- Engine & Care
- Cleaning & Care
- Paint & Paint Acc.
- Fun & Flotation
- Topside Acc.
- Cockpit & Deck
- Hardware, Fasteners
- Camouflage
- Misc.
- Comm.

Steiner Marine 7 x 50 Binoculars



- 7x Magnification is the marine standard, with a wide, stable image for tracking other boats, buoys and bridge numbers even in rough water.
- High Contrast Optics provide bright, sharply contoured images with natural color definition for outstanding viewing quality.
- Floating Prism System uses flexible silicon lens mount to absorb severe shock, impact and abuse without damage.
- Sports-Auto Focus System lets you focus each eyepiece to your vision once, then keeps images razor sharp from 20 yards to infinity.
- Waterproof and Rubber Armored durable construction that can stand up to wet conditions and ergonomic ridges and pads for a secure, comfortable grip.
- Magnification: 7x. Objective lens: 50. Field of view: 356 ft.

Order No.	Mfg. No. / Description	List Price
548238	(575)	\$453.79 FO-5671300

Marpac Number and Letter Kits



- Contains: 4 of each number and letter - plus 16 dashes!
- 3" tall block style.
- Ideal for boat registration and identification numbers.
- Great for adding vessel names to life ring buoys.
- Black self-aligning. Pressure sensitive mylar.
- Meets Coast Guard requirements.

Order No.	Description	List Price
7-0780	Number and Letter Kit, White	\$5.49 GO-8630000
7-0782	Number and Letter Kit, Black	\$5.49 GO-8630000

Boater Sports 3" Letter and Number Kits



7-52290



- Custom Letter Kits include 4 sets of the letters A-Z and the numbers 0-9 (146 total) plus 16 dashes.
- Fuel, fading and scratch resistant. UV Coated.
- Meets US Coast Guard guidelines when properly applied on contrasting background.

Order No.	Mfg. No. / Description	List Price
7-52290	(52290) 3" Shaded - White/Black	\$14.19 GO-1590000
1-52310	(52310) 3" Block - Blue	\$10.69 HO-1460000

Boater Sports 3" New Style - Outlined Letter and Number Kits



- Premium Letter and Number Kits.
- Great looks for your boat with the new black or white fade outline
- Features high grade vinyl and adhesive for seasons of use
- Convenient new package minimizes need for large footprint at retail.
- Meets USCG Regulations when applied correctly.

Order No.	Mfg. No. / Description	List Price
1-52318	(52318) Black Outline	\$17.49 HO-9401000

Davis Queaz-Away Travelers' Wristbands



- A non-drug aid for people on the go.
- The unpleasant effects of winding roads, rough seas, bumpy flights, rocking trains and spinning Ferris wheels can ruin a trip or outing.
- Queaz-Away wristbands exert gentle pressure on points of each wrist, easing the miserable effects of travel.
- Made of tough, long-lasting, washable materials.
- One size fits all. Handy carrying case included. Sold per pair.

Order No.	Mfg. No. / Description	List Price
499818	(400)	\$7.49 FO-4250000

Hardline Products Series 200 Registration Kits



- This 3" size factory-matched kits includes 4 sets of the letters A-Z and 0-9, for a total of 146 decals.
- Series 200: Outline color shades into body color for that custom airbrushed look.

Order No.	Mfg. No.	Color	Outline	List Price
659273	(REBKG200)	Red w/Black Fade	Black	\$21.49 HO-9821000
659275	(TEBKG200)	Teal w/Black Fade	Black	\$21.49 HO-9821000
659277	(BLBKG200)	Blue w/Black Fade	Black	\$21.49 HO-9821000
2560041	(BJBKG200)	Bluejay w/Black Fade	Black	\$21.49 HO-9821000
2560047	(BLK200EC)	Black		\$10.79 HO-7460000
2560050	(BLKKI200)	Black	Kiwi	\$21.49 HO-9821000
2560053	(BMBKG200)	Blue Metallic	Black	\$21.49 HO-9821000
2560061	(PUTEG200)	Purple w/Teal Fade	Teal	\$21.49 HO-9821000
2560066	(REPUG200)	Red w/Black Fade	Purple	\$21.49 HO-9821000
2560080	(WHI200EC)	White		\$10.79 HO-7460000
2560085	(YEPUG200)	Yellow w/Purple Fade	Purple	\$21.49 HO-9821000
257510	(BRBKG200)	Brown w/Black Fade	Black	\$21.49 HO-9821000
257520	(CHBKG200)	Chrome w/Black Fade	Black	\$24.79 HO-7841000
257540	(RUBKG200)	Burgundy w/Black Fade	Black	\$21.49 HO-9821000
257545	(SIBKG200)	Silver w/Black Fade	Black	\$21.49 HO-9821000
257560	(WHBKG200)	White w/Black Fade	Black	\$21.49 HO-9821000
257565	(YEBKG200)	Yellow w/Black Fade	Black	\$21.49 HO-9821000

- Electronics
- Trolling Motors
- Instruments
- Electrical
- Lighting
- Anchor & Dock
- Safety
- Steering, Controls
- Pumps
- Fuel System
- Seating & Pedestals
- Trailer
- Tops & Covers
- Perform.
- Propellers
- Engine & Care
- Cleaning & Care
- Paint & Paint Acc.
- Fun & Flotation
- Topside Acc.
- Cockpit & Deck
- Hardware, Fasteners
- Camouflage
- Misc.
- Comm.

- Electronics
- Trolling Motors
- Instruments
- Electrical
- Lighting
- Anchor & Dock
- Safety
- Steering, Controls
- Pumps
- Fuel System
- Seating & Pedestals
- Trailer
- Tops & Covers
- Perform.
- Propellers
- Engine & Care
- Cleaning & Care
- Paint & Paint Acc.
- Fun & Flotation
- Topside Acc.
- Cockpit & Deck
- Hardware, Fasteners
- Camouflage

Hardline Products Series 300 Registration Kits



- This 3" size factory-matched number kit includes 4 sets of the letters A-Z and the numbers 0-9, for a total of 146 decals.
- These number kits resist fuel, fading and scratches.
- They are UV coated for protection from the sun and meet the US Coast Guard guidelines when installed correctly.

Order No.	Mfg. No.	Color	Outline	List Price
2560043	(BLBKG300)	Blue w/Black Fade	Black	\$21.49 HO-9821000
2560055	(BRBKG300)	Brown w/Black Fade	Black	\$21.49 HO-9821000
2560058	(CHBKG300)	Chrome w/Black Fade	Black	\$24.79 HO-7841000
2560063	(REBKG300)	Red w/Black Fade	Black	\$21.49 HO-9821000
2560073	(SIBKG300)	Silver w/Black Fade	Black	\$21.49 HO-9821000
2560078	(WHBKG300)	White w/Black Fade	Black	\$21.49 HO-9821000
2560083	(YEBKG300)	Yellow w/Black Fade	Black	\$21.49 HO-9821000

Hardline Products Series 320 Registration Kits



- Series 320 - solid color block font with a drop shadow.
- Complete sets of registration letters & numbers for boat, or PWC.
- Factory Matched colors from the manufacturer.
- These number kits resist fuel, fading and scratches.
- Are UV coated for protection from the sun.
- Meet US Coast Guard guidelines and include 4 sets of A-Z, 0-9, for a total of 146 decals.
- 100 mph tested.

Order No.	Mfg. No.	Color	Outline	List Price
257505	(BLKSI320)	Black	Silver	\$21.49 HO-9821000
257515	(BRBLK320)	Brown	Black	\$26.29 HO-7751000
257535	(REBLK320)	Red	Black	\$21.49 HO-9821000
257550	(SIBLK320)	Silver	Black	\$21.49 HO-9821000
2560045	(BLBLK320)	Blue	Black	\$21.49 HO-9821000

Hardline Products Series 350 Registration Kits



- Series 350 - solid color block font.
- Complete sets of registration letters & numbers for boat, or PWC.
- Factory Matched colors from the manufacturer.
- These number kits resist fuel, fading and scratches.
- Are UV coated for protection from the sun.
- Meet US Coast Guard guidelines and include 4 sets of A-Z, 0-9, for a total of 146 decals.
- 100 mph tested.

Order No.	Mfg. No.	Color	List Price
2560048	(BLK350EC)	Black	\$10.79 HO-7460000
2560052	(BLU350EC)	Blue	\$10.79 HO-7460000
2560081	(WHI350EC)	White	\$10.79 HO-7460000

Hardline Products Series 400 Registration Kits



- This 3" size factory-matched number kit includes 4 sets of the letters A-Z and the numbers 0-9, for a total of 146 decals.
- These unique number kits set themselves apart from other styles with shading from left to right of each character.
- Evolutionary shadowing and stroke graphics make these number kits a popular pick.
- These number kits resist fuel, fading and scratches.
- They are UV coated for protection from the sun and meet the US Coast Guard guidelines when installed correctly.

Order No.	Mfg. No.	Color	Outline	List Price
2560044	(BLBKG400)	Blue	Black	\$21.49 HO-9821000
2560049	(BLK400EC)	Black		\$10.79 HO-7460000
2560059	(CHBKG400)	Chrome	Black	\$24.79 HO-7841000
2560064	(REBKG400)	Red	Black	\$21.49 HO-9821000
2560071	(RUBKG400)	Burgundy	Black	\$21.49 HO-9821000
2560074	(SIBKG400)	Silver	Black	\$21.49 HO-9821000
2560079	(WHBKG400)	White	Black	\$21.49 HO-9821000
2560084	(YEBKG400)	Yellow	Black	\$21.49 HO-9821000

- Misc.
- Comm.

Injury Plaque

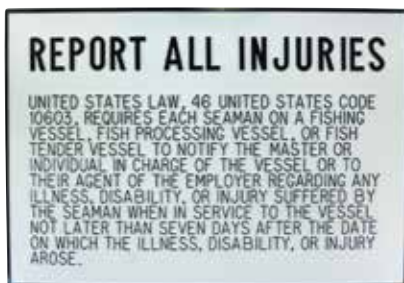

- Meets federal requirements on commercial vessels.
- Black on white background with adhesive backing.

Order No. Mfg. No. / Description List Price
255952 (P-230) Dimensions: 8-5/8" x 5-7/8" **\$15.49** H0-9290000

Pollution Control Plaque

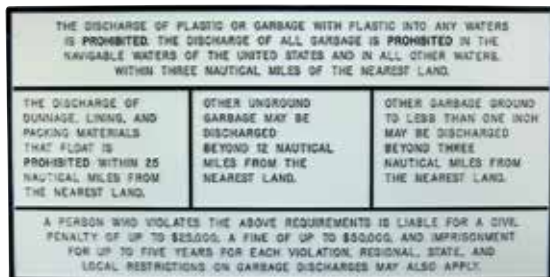

- Meets federal standards.
- Required on all boats 26' to display overboard discharge laws.
- Adhesive strip backing. Easy to apply.
- Black text on white plastic background.

Order No. Mfg. No. / Description List Price
255948 (P-227) Dimensions: 9-1/4" x 4-1/2" **\$12.39** H0-3470000

Marpac Key Float



- 2-piece key float.

Order No. Description List Price
7-52286 Key Float **\$2.19** G0-7410000

Marpac Floating Key Chain



- High visibility.
- Durable soft foam.
- Holds up to 4 keys.

Order No. Description List Price
7-52284 Floating Key Chain **\$2.99** G0-0020000

Drug Plaque



- Meets federal requirements on commercial vessels.
- Easy to apply.
- Adhesive backing.

Order No. Mfg. No. / Description List Price
255949 (P-229) Dimensions: 6-3/4" x 4" **\$12.39** H0-3470000

Oil Discharge Plaque

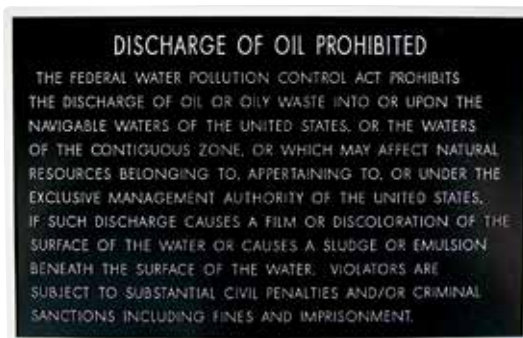

- Meets federal standards.
- Required on all boats 26' and over with enclosed engine compartment.
- Adhesive strip backing. Easy to apply.
- White text on black background.

Order No. Mfg. No. / Description List Price
255946 (P-204) Dimensions: 8" x 5" **\$9.39** H0-3650000

Boater Sports Key Float/Registration Holder



Order No. Mfg. No. / Description List Price
1-52261 (52261) Red **\$3.59** H0-5120000

- Electronics
- Trolling Motors
- Instruments
- Electrical
- Lighting
- Anchor & Dock
- Safety
- Steering, Controls
- Pumps
- Fuel System
- Seating & Pedestals
- Trailer
- Tops & Covers
- Perform.
- Propellers
- Engine & Care
- Cleaning & Care
- Paint & Paint Acc.
- Fun & Flotation
- Topside Acc.
- Cockpit & Deck
- Hardware, Fasteners
- Camouflage
- Misc.
- Comm.

Custom Key Float Program

Dealer name _____ Dealer number _____ SHOW _____
 Phone _____ Fax _____ Date _____
 Dealer email address for proof _____



677 Cochran Steet
 Simi Valley, CA 93065
 805-581-4700 phone
 805-581-0022 fax
 sales@hardlineproducts.com

Art on File? yes _____ no _____ \$50 new art one time charge.
 Art work must be supplied on disk or emailed in high resolution
 jpeg, eps or tiff format only. Custom order key float 250 pcs. minimum.

1 side _____
 2 sides _____ additional \$.10
 \$20 color change if differnt ink color from 1st side.

If dealer does not have logo or artwork they can choose from 3 differnt font styles below. (Circle one)
 Pick float color and ink color. Choices are RKF, WKF, BKF, YKF,
 Live Area is 3/4" X 2" approx.



ORDER NUMBER	Key Float COLOR	Ink COLOR	Descript	SUG. DEALER	Qty.
RKF	red	na	blank	\$1.64	
RKF-BK	red	white	boat keys	\$1.64	
RKF-GIS	red	white	get in sit..	\$1.64	
WKF	white	na	custom	\$1.64	
WKF-BK	white	blue	boat keys	\$1.64	
WKF-GIS	white	blue	get in sit..	\$1.64	
BKF	blue	na	blank	\$1.64	
BKF-BK	blue	white	boat keys	\$1.64	
BKF-GIS	blue	white	get in sit..	\$1.64	
YKF	yellow	na	blank	\$1.64	
YKF-BK	yellow	black	boat keys	\$1.64	
YKF-GIS	yellow	black	get in sit..	\$1.64	
LL-12	yellow	green	bass	\$1.64	
L-12	yellow	blue	ski grl.	\$1.64	
M-12	yellow	black	marlin	\$1.64	
AN-12	yellow	black	anchor	\$1.64	
SD-12	yellow	black	scuba	\$1.64	
CS-01	24pcs mixed	mixed	clip strip	\$42.13	
X-24	24pcs mixed	bass & ski girl	pop box	\$42.13	

Dealer art on file Copy for Key Float
 250 pcs. min for custom key float

All artwork must be submitted ready to print as is. We will make our best attempt to center the image on the key float unless otherwise indicated.
 We only accept High resolution AI, EPS and PDF files. We need your file to have been created in Adobe Illustrator (or another drawing program) and saved as an EPS or AI or JPEG file. All fonts must be saved as "Outlines". Files created in Photoshop or taken off the internet (rasterized) will print with jagged edges on all sides of the graphics. If we do not have a vector file (made from shapes) we will have to regenerate the artwork at a \$60 fee. All files must be one color setup.
 No dropshadows, outlines or fades. If your artwork is wrong and you sign off on the proof then your Key float will print wrong. What you submit is what we print.

Subtotal _____
Discount _____
Shipping _____
Total _____

- Electronics
- Trolling Motors
- Instruments
- Electrical
- Lighting
- Anchor & Dock
- Safety
- Steering, Controls
- Pumps
- Fuel System
- Seating & Pedestals
- Trailerling
- Tops & Covers
- Perform.
- Propellers
- Engine & Care
- Cleaning & Care
- Paint & Paint Acc.
- Fun & Flotation
- Topside Acc.
- Cockpit & Deck
- Hardware, Fasteners
- Camouflage

- Misc.
- Comm.

Grid Panels

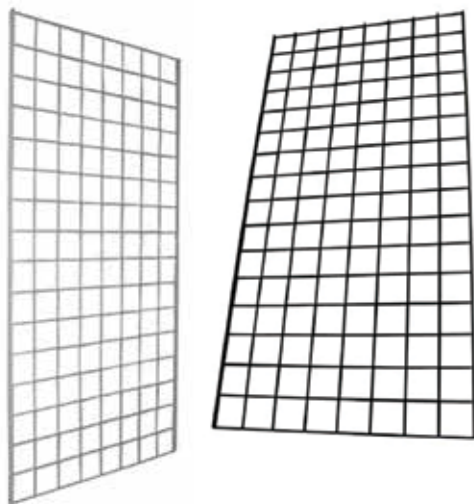

Order No.	Mfg. No. / Description	List Price
2000956	(10-026BL-3) 2' x 6' Black	\$20.19 A0-9102000
2000970	(10-027WH-3) 2' x 7' White	\$23.49 A0-9432000

Grid Universal Panel Joiner Clips



• Hardware to join panels of grid.

Order No.	Mfg. No. / Description	List Price
2000967	(12-016BL) Black	\$0.29 A0-9200000
2000979	(12-016WH) White	\$0.29 A0-9200000

Hooks for Grid

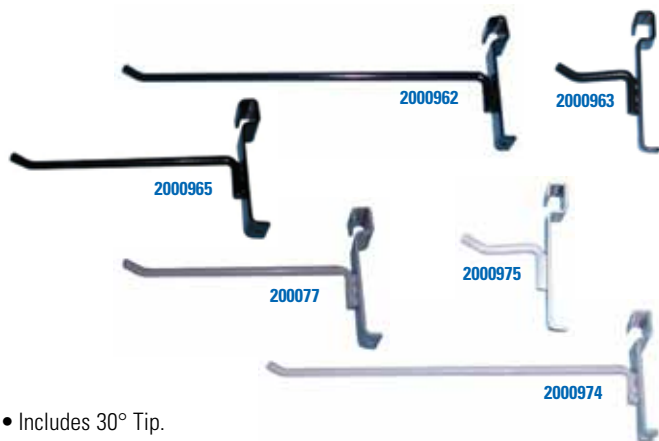

• Includes 30° Tip.

Order No.	Mfg. No. / Description	List Price
2000963	(14-002BL) Length 2" Black	\$0.29 A0-9200000
2000964	(14-004BL) Length 4" Black	\$0.39 A0-9300000
2000965	(14-006BL) Length 6" Black	\$0.39 A0-9300000
2000966	(14-008BL) Length 8" Black	\$0.49 A0-9400000
2000962	(14-010BL) Length 10" Black	\$0.49 A0-9400000
2000975	(14-002WH) Length 2" White	\$0.29 A0-9200000
2000976	(14-004WH) Length 4" White	\$0.39 A0-9300000
2000977	(14-006WH) Length 6" White	\$0.39 A0-9300000
2000978	(14-008WH) Length 8" White	\$0.49 A0-9400000
2000974	(14-010WH) Length 10" White	\$0.49 A0-9400000

Grid Bases with Casters



Order No.	Mfg. No. / Description	List Price
2000958	(12-003BL) 3-Way Base Black	\$23.69 A0-9632000
2000971	(12-003WH) 3-Way Base White	\$23.69 A0-9632000
2000959	(12-004BL) 4-Way Base Black	\$28.39 A0-9382000
2000972	(12-004WH) 4-Way Base White	\$28.39 A0-9382000

Grid Wall Mount Holders



• Length 2-1/2".

Order No.	Mfg. No. / Description	List Price
2000968	(12-015BL) Black	\$0.89 A0-9800000
2000980	(12-015WH) White	\$0.99 A0-9900000

Waterfalls for Grid

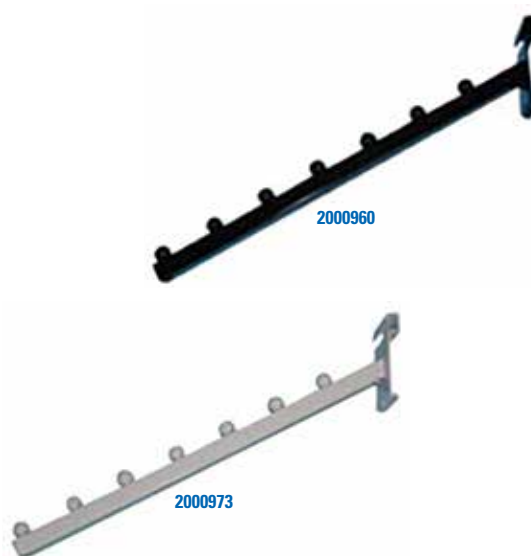

• Square tubing.
• 7 balls on tube.

Order No.	Mfg. No. / Description	List Price
2000960	(13-005BL) Black	\$2.59 A0-9520000
2000973	(13-005WH) White	\$2.59 A0-9520000

- Electronics
- Trolling Motors
- Instruments
- Electrical
- Lighting
- Anchor & Dock
- Safety
- Steering, Controls
- Pumps
- Fuel System
- Seating & Pedestals
- Trailering
- Tops & Covers
- Perform.
- Propellers
- Engine & Care
- Cleaning & Care
- Paint & Paint Acc.
- Fun & Flotation
- Topside Acc.
- Cockpit & Deck
- Hardware, Fasteners
- Camouflage
- Misc.
- Comm.



SPECIAL HANDLING MAY APPLY



Marpac Peg Board Hooks



- .148 diameter.
- Sold 25 hooks per pack.

Order No.	Description	List Price
7-0549	2"	\$13.59 GO-1190000
7-0548	4"	\$22.29 GO-3941000
7-0546	6"	\$24.79 GO-1661000
7-0547	8"	\$26.99 GO-8081000

Header Card Kit



- Keep things organized with these attractive header cards.
- Signs included for:

Accessories	Engine Care	Lights	Safety
Boat Care	Fishing	Mooring	Seats
Electrical	Fuel	Promotion	Trailer
Electronics	Hardware	Pumps	Water Sports

Order No.	Description	List Price
101100	Header Card Kit	\$88.99 GO-2695000

Marpac Rolling Display Rack



- Place where ever it's needed most.
- Measures: 36" x 48" tall.
- Black wire rack includes: 12 large and 12 small hooks.
- Two complete rack assemblies included per package.

Order No.	Description	List Price
7-8998	Rolling Display Rack	\$201.99 GO-3353100

Sign Holder



- These 6" x 1-1/8" sign holders are made of clear plastic with a self adhesive base.

Order No.	Description	List Price
101129	Sign Holder	\$2.29 D0-3810000

Guest Oscillating Marine Fan



- 120° adjustable oscillating fan.
- Folds out of the way when it's not in use and can be mounted on the wall, ceiling or dash.
- Built-in on/off switch.
- Translucent fan blades.
- 7-1/2" vinyl-coated fan guard.
- Stands 8" from mounting surface.
- Mounting base dim.: 3-3/8" L x 1-1/2" W.
- 12 volt, 1.2 amp draw.

Order No.	Mfg. No. / Description	List Price
379049	(900)	\$118.89 FO-2238000

Marpac Marine Cabin Fan



- Weatherproof vinyl coated fan guard.
- Easy installation.
- Fixed or 90° "sweep" motion.
- 8 preset fan positions with adjustable tilt.
- 12 volt.

Order No.	Description	List Price
7-0117	Marine Cabin Fan	\$23.19 GO-4551000

KeelShield® Keel Guard



- Just Prep, Peel and Stick - No Down Time!
- KeelShield brand keel protectors provide the strongest most durable protection for your hull.
- Protects your keel from abrasion, scratches and scars from concrete ramps, rocky shores, beaching, launching, loading and submerged objects.
- Made of DOW Urethane Polymers and the best 3M adhesive system available.
- Works on fiberglass, most aluminum and most personal watercraft.
- You want the #1 keel protector than look for the KeelShield Gator.
- Made with pride in the USA.
- Lifetime warranty.

Order No.	Mfg. No. / Description	List Price
482013	(KS5BLK) Black Length 5'	\$136.49 F0-4559000
482016	(KS5WHT) White Length 5'	\$136.49 F0-4559000
402019	(KS6BLK) Black Length 6'	\$163.79 F0-5641100
482018	(KS-6LGY) Light Gray Length 6'	\$163.79 F0-5641100
4830017	(KS-6DGY) Dark Gray Length 6'	\$163.79 F0-5641100
482020	(KS6WHT) White Length 6'	\$163.79 F0-5641100
482022	(KS7BLK) Black Length 7'	\$191.09 F0-6733100
482026	(KS7LGY) Light Gray Length 7'	\$191.09 F0-6733100
482028	(KS7WHT) White Length 7'	\$191.09 F0-6733100
4830024	(KS-7OWH) Off White Length 7'	\$191.09 F0-6733100
482030	(KS8BLK) Black Length 8'	\$218.39 F0-7825100
4830030	(KS-8LGY) Light Gray Length 8'	\$218.39 F0-7825100
482034	(KS8WHT) White Length 8'	\$218.39 F0-7825100
4830031	(KS-8OWH) Off White Length 8'	\$218.39 F0-7825100

BowShield Bow Guard



- Guaranteed bow protection from docks, trailer stops and bow rollers.
- Made of durable 316 marine grade mirror finish stainless steel.
- Pre-creased centerline for easy bending and fitting.
- It is easy to apply and comes complete with a 24 hour cure urethane adhesive for a permanent installation.
- Prevent damage preserve value.
- 3 year warranty for original purchaser.

Order No.	Mfg. No. / Description	List Price
402017	(BSS) Small 6-1/2" x 6"	\$38.79 F0-5172000
402018	(BSM) Medium 7-1/2" x 9"	\$44.89 F0-2413000

Hamby's Protector The "Original" Beaching Bumper



- Made from only the highest quality Dow and Dupont polymers and are injection molded one at a time to provide a unique sleek design.
- The Original Beaching Bumper is professionally installed using an epoxy adhesive and fiberglass matting which ensures a long lasting bond.
- Hamby's Beaching Bumpers are sold only to Hamby's Authorized Installing Dealers. To become a installing dealer the first purchase is a minimum of 4 or more Original Hamby's Beaching Bumpers.
- Any new dealer will receive all required tools and instructions at no extra charge.
- Total installation kit worth approximately \$150.00.
- Installation kit will be drop shipped.

Order No.	Mfg. No. / Description	List Price
2000948	(H-6-BLK) Black Length 6'	\$400.49 F0-4308200
2000950	(H-8-BLK) Black Length 8'	\$435.19 F0-3640300

Hamby's Protector Light Duty Beaching Bumper



- Super tough urethane.
- Injection molded one at a time.
- 3M VHB (Very High Bond) Adhesive.
- 5/16" thick.
- 6' long by 5" wide.
- Tapered edge enhances the appearance.
- Easy to install.
- Backed up by the Hamby's name, the leader in the keel protection industry.

Order No.	Mfg. No. / Description	List Price
2000951	(HLD-BLK) Black 6' x 5"	\$247.19 F0-3037100



SPECIAL HANDLING MAY APPLY



- Electronics
- Trolling Motors
- Instruments
- Electrical
- Lighting
- Anchor & Dock
- Safety
- Steering, Controls
- Pumps
- Fuel System
- Seating & Pedestals
- Trailer
- Tops & Covers
- Perform.
- Propellers
- Engine & Care
- Cleaning & Care
- Paint & Paint Acc.
- Fun & Flotation
- Topside Acc.
- Cockpit & Deck
- Hardware, Fasteners
- Camouflage
- Misc.
- Comm.

Imtra Roca Wiper Systems - W10 Series



- A compact system for windows with a maximum reach of 35".
- Self-parking (right or left).
- Solid brass, nickel-plated, knurled drive nut and bearing.
- Stainless steel drive shaft, mounting bracket and fasteners.
- Proprietary motor magnets for quieter operation.
- Sweep angle adjustment: 10° increments.
- Sweep angle range: 40° - 110°.
- Sweeps per minute: 35 (low), 55 (high).
- Max arm: 24". Max blade: 22".
- Order motor, arm and blade separately.

Order No.	Mfg. No.	Shaft Length	Bulkhead Thickness	List Price
679413	(RC524991) 12 volt	2"	1-5/8"	\$184.49 H0-9601100
679451	(RC524992) 24 volt	2"	1-5/8"	\$213.99 H0-9382100
679425	(RC525891) 12 volt	3"	2-5/8"	\$191.19 H0-1741100

Imtra Exalto Type 1 Wiper System



- A premier continuous duty wiper system for windows under 46.9" in height.
- Dynamically parks (right or left).
- Bulkhead thickness: 3/4".
- 316 stainless steel drive and idler shafts.
- Stepless adjustable sweep angle from 40° - 90°.
- Allows tuning of wiping angle to maximize cleared area.
- Sweeps per minute: 40 (low), 60 (high).
- Max arm: 31.1". Max blade: 31.5".
- Order motor, arm and blade separately.

Order No.	Mfg. No. / Description	List Price
679670	(EXA2168.30) 24 volt	\$784.19 H0-1507400

Imtra Exalto Combination Rotary Switches



- Variable intermittent time delay.
- Continuous low and high speed.
- Push button wash function.
- Dynamic park or coast to park.
- For use with Exalto Wiper Motors.

Order No.	Mfg. No. / Description	List Price
679414	(EX2158) 12 volt	\$166.29 H0-7799000
679415	(EX2159) 24 volt	\$172.99 H0-9730100

Imtra Coastal Plus Pendulum Wiper Arms - W10/W12 Series



- Constructed of 304 stainless steel and UV-stable synthetics.
- Easy snap-in blade connection.
- Adjustable length wiper arms.
- Fits most motors with .54" shaft diameter.
- Black.
- Adjustable tip blade connection.
- Accept standard wiper blades only.

Order No.	Mfg. No. / Description	List Price
679416	(RC538218) Adjustable from 13" to 18"	\$62.99 H0-9773000
679417	(RC538224) Adjustable from 18" to 24"	\$65.19 H0-1193000

Imtra Roca Wiper Blades - W Series



- Designed to fit Roca wiper arms, as well as AFI/Marinco and Ongaro arms.
- Powder-coated steel with durable rubber insert.
- Includes: Mounting clips suitable for other attachment methods.

Order No.	Mfg. No. / Description	List Price
679418	(RC520912) Length 12"	\$14.39 H0-3680000
679419	(RC520914) Length 14"	\$16.39 H0-3890000
679420	(RC520918) Length 18"	\$20.59 H0-5321000
679421	(RC520922) Length 22"	\$25.29 H0-7151000

Imtra Exalto Type 1 Pantograph Wiper Arms



- 316 stainless steel components with brass attachment heads.
- Adjustable length wiper arms.
- Adjustable spring mechanism in drive gallery.
- Low-glare black polyester epoxy coating over sandblasted stainless steel surface for durable finish.
- Accepted blade length: 11.8" to 31.5".

Order No.	Mfg. No. / Description	List Price
679675	(EX2136AS) Adjustable from 20.7" to 25.6"	\$489.29 H0-7539200

Imtra Exalto Heavy Duty Wiper Blades - Type 1



- Durable stainless steel upper bridges with high-impact polymer lower bridges for optimal blade/glass contact.

Order No.	Mfg. No. / Description	List Price
679683	(EX216122) Length 27.5"	\$142.99 H0-9758000
679685	(EX216123) Length 29.5"	\$124.79 H0-7847000

Trico Air Pressure Windshield Wiper Power Units

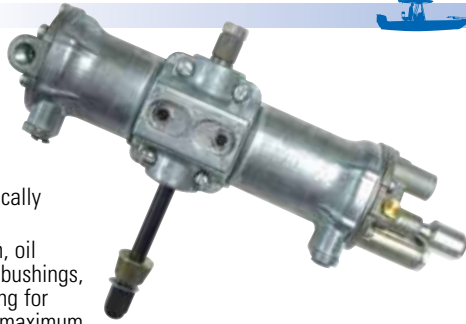

- 90° stroke, automatically parks on left side.
- Low air consumption, oil impregnated bronze bushings, molded piston packing for greater air seal and maximum power.
- Shaft not included.

Order No.	Mfg. No. / Description	List Price	
662797	(FPDP-60L) 60° Sweep	\$396.59	H0-5973200
662812	(FPDP-80L) 80° Sweep	\$396.59	H0-5973200

Trico Windshield Wiper Blades for Flat Windshields - 61 Series



- Adapter included.

Order No.	Mfg. No. / Description	List Price	
662898	(61-180 (5)) Length 18"	\$23.98	H0-9341000
662901	(61-210 (5)) Length 21"	\$21.98	H0-9131000

Marpac Self-Parking Windshield Wiper Kit



- Motor waterproof to stringent IP66 standards.
- 80° or 110° sweep angle.
- Adjustable self-parking position.
- Corrosion resistant powder coated aluminum alloy motor body with stainless steel shaft.
- Excellent for flat or curved windshields.
- 11" blade composite blade with marine grade rubber squeegee.
- Stainless steel powder coated arm adjusts from 11"-14".
- Single speed.
- Easy to install.
- CE approved.

Order No.	Description	List Price	
7-0447	Windshield Wiper Kit	\$108.39	G0-2627000
7-0445	Adjustable Wiper Arm	\$23.89	G0-1061000
7-0446	Wiper Blade	\$9.29	G0-2260000

Trico Adjustable Wiper Arm - 73 Series



- A silver finish and feature an adjustable saddle and arm length.
- Includes: Adjustable saddle to hold blade, cap nut, washer and knurled driver for attachment to flat taper shaft.

Order No.	Mfg. No. / Description	List Price	
662709	(44-05) Adjustable from 14" to 18"	\$86.59	H0-5915000

Trico Flat Taper Shafts - Model JF-1376



Order No.	Mfg. No. / Description	List Price	
662874	(JF1376-76K) Length 5-7/16"	\$65.79	H0-7493000
662886	(JF1376-107K) Length 6-11/16"	\$66.49	H0-9893000
662850	(F1376-12K) Length 8-7/16"	\$50.98	H0-9503000
662862	(SP4080-1A) Shaft Attachment Kit	\$73.98	F0-9715000

Marinco 500 Wiper Kits



- Kits include: 500 Waterproof Wiper Motor with 11.5" deluxe stainless steel curved blade (33004) and deluxe adjustable (6.75" to 10.5") stainless steel arm (33006AS).
- Motor is self-parking, totally sealed and 100% waterproof.
- Motor housing is UV stabilized high-temperature, high-impact thermoplastic.
- Windshield mount: .5" shaft diameter.
- Shaft length 2-1/2".
- Maximum current draw: 2 amps.
- 12 volt.

Order No.	Mfg. No. / Description	List Price	
215144	(30004) 80° Sweep	\$239.49	F0-4676100
215168	(30005) 110° Sweep	\$239.49	F0-4676100

- Electronics
- Trolling Motors
- Instruments
- Electrical
- Lighting
- Anchor & Dock
- Safety
- Steering, Controls
- Pumps
- Fuel System
- Seating & Pedestals
- Trailer
- Tops & Covers
- Perform.
- Propellers
- Engine & Care
- Cleaning & Care
- Paint & Paint Acc.
- Fun & Flotation
- Topside Acc.
- Cockpit & Deck
- Hardware, Fasteners
- Camouflage
- Misc.
- Comm.

Wiper Adjustable Arms



Order No.	Mfg. No. / Description	List Price
679502	(LE721156S) Adjustable Arm	\$57.49 HO-9443000
679505	(LE581022-1S) Adjustable H/D Arm, 11" to 15"	\$59.49 HO-9653000
679506	(LE581022-2S) Adjustable H/D Arm, 15" to 19"	\$53.19 HO-1913000
679653	(RC520160) Small Parts Kit for WWF Wiper	\$7.98 FO-9550000

Wiper Arm Blades



USE WITH 679502 ADJUSTABLE ARM

Order No.	Mfg. No. / Description	List Price
679487	(BD721020-12S) Length 12"	\$38.29 HO-7922000

HEAVY DUTY BLADE - USE WITH 679505 OR 679506 ADJUSTABLE ARMS

Order No.	Mfg. No. / Description	List Price
679510	(BD721011-14S) Length 14"	\$19.49 HO-9611000
679515	(BD721011-18S) Length 18"	\$23.19 HO-1931000
679520	(BD721011-22S) Length 22"	\$25.79 HO-7451000

- Electronics
- Trolling Motors
- Instruments
- Electrical
- Lighting
- Anchor & Dock
- Safety
- Steering, Controls
- Pumps
- Fuel System
- Seating & Pedestals
- Trailer
- Tops & Covers
- Perform.
- Propellers
- Engine & Care
- Cleaning & Care
- Paint & Paint Acc.
- Fun & Flotation
- Topside Acc.
- Cockpit & Deck
- Hardware, Fasteners
- Camouflage
- Misc.
- Comm.

Marpac Safety Snaps



- Stainless steel.

Order No.	Description	Gauge	OD	List Price
7-0284	Length Overall 2-1/2"	Gauge OD 1/4"		\$3.89 GO-1620000
7-0285	Length Overall 3-1/8"	Gauge OD 5/16"		\$5.89 GO-5930000
7-0286	Length Overall 4"	Gauge OD 3/8"		\$9.49 GO-6360000
7-0290	Length Overall 4-3/4"	Gauge OD 7/16"		\$13.09 GO-7780000

Marpac Safety Spring Hooks



- Plated steel.
- Interlocking tongue to insure safety.
- Spring loaded.
- Capacity shown in safe working load.
- Slide blister pack.

Order No.	Description	Safe Work Load	List Price
7-54333	4-1/4"	900 lbs.	\$5.29 GO-4530000

Mossy Oak® Camouflage Safety Spring Hook



- Interlocking tongue, spring loaded.
- Mossy Oak Shadow Grass Blades pattern.

Order No.	Mfg. No. / Description	List Price
1-34072	(34072) 3-1/8"	\$3.89 EO-2920000

Marpac Solid Brass Swivel Eye Snap Hooks



- Solid brass.

Order No.	Description	Sold	List Price
7-0280	3-1/4" L with 5/8" Eye ID	Two Per Card	\$8.29 GO-5550000
7-0281	3-5/8" L with 3/4" Eye ID	One Per Card	\$5.09 GO-1430000
7-0282	4-1/2" L with 7/8" Eye ID	One Per Card	\$6.49 GO-5340000

Perko Swivel Eye Snap



- Chrome plated zinc alloy.
- Interlocking tongue with spring.
- Eye ID 5/8".
- Length overall 3".

Order No.	Mfg. No. / Description	List Price
531574	(1289 DPO CHR)	\$10.19 GO-3860000

Marpac Solid Bronze Fixed Eye Snap Hooks



- Solid bronze.

Order No.	Description	Eye ID	List Price
7-0278	Length Overall 2-1/8"	3/8"	\$4.69 GO-4130000
7-0279	Length Overall 2-7/8"	5/8"	\$3.59 GO-1420000
7-0685	Length Overall 3-1/4"	11/16"	\$6.99 GO-8640000
7-1350	Length Overall 3-7/8"	3/4"	\$6.59 GO-2440000

Marpac Utility Snap Hook



- Forged zinc plated steel.
- 1,000 lbs. breaking strength.

Order No.	Overall	Dia.	Opening	Eye ID	List Price
7-0289	4-1/2"	3/4"	1"	2-1/2"	\$2.89 G0-4910000

Mossy Oak® Camouflage Universal Snap Hook



- Spring loaded.
- Mossy Oak Shadow Grass Blades pattern.

Order No.	Mfg. No. / Description	List Price
1-34073	(34073)	\$4.49 E0-7330000

Marpac Snap Hook



- Malleable iron.
- 2,300 lbs. breaking strength.

Order No.	Description	List Price
7-0288	Length 3-1/2" Eye 2"	\$4.19 G0-1820000

Marpac Solid Brass Swivel Eye Bolt Snap Hooks



- Solid brass.

Order No.	Description	List Price
7-1360	Length Overall 3-1/4" 3/4" Eye ID	\$6.49 G0-5340000
7-1362	Length Overall 3-1/2" 1" Eye ID	\$4.29 G0-7820000

Boater Sports Utility Winch Hook - Long



- 4-1/4" spring loaded closure, heavy duty zinc plated steel hook.
- Safe working load: 2,000 lbs.
- Slide blister pack.

Order No.	Mfg. No. / Description	List Price
1-54337	(54337)	\$5.49 HO-9230000

Boater Sports Utility Winch Hook - Zinc Plated



- 4" spring loaded closure, heavy duty zinc plated steel hook.
- Safe working load: 1,500 lbs.
- Slide blister pack.

Order No.	Mfg. No. / Description	List Price
1-54336	(54336)	\$5.09 HO-5030000

- Electronics
- Trolling Motors
- Instruments
- Electrical
- Lighting
- Anchor & Dock
- Safety
- Steering, Controls
- Pumps
- Fuel System
- Seating & Pedestals
- Trailering
- Tops & Covers
- Perform.
- Propellers
- Engine & Care
- Cleaning & Care
- Paint & Paint Acc.
- Fun & Flotation
- Topside Acc.
- Cockpit & Deck
- Hardware, Fasteners
- Camouflage
- Misc.
- Comm.

Pelican Release Hook - Stainless Steel



- Cast 316 stainless steel.
- Feature a hinged link that can be quickly secured or released by a sliding ring.
- Capable of being released under load these hooks are used as a removable fastener in lifeline applications where a gate is required.
- Eye allows line to be spliced directly to the hook or attached by way of a turnbuckle fork.
- Length overall 4". Eye ID 1/2" x 3/8".

Order No.	Mfg. No. / Description	List Price
310413	(DHK01002)	\$43.09 B0-8783000

Pelican Release Hook - Cast Bronze



- Cast bronze.
- Feature a hinged link that can be quickly secured or released by a sliding ring.
- Capable of being released under load these hooks are used as a removable fastener in lifeline applications where a gate is required.
- Eye allows line to be spliced directly to the hook or attached by way of a turnbuckle fork.
- Length overall 4". Eye ID 1/2" x 3/8".

Order No.	Mfg. No. / Description	List Price
691041	(189780)	\$15.69 G0-1501000

Marpac Padlocks



- Includes: 2 nickel plated brass keys.
- Solid brass body and shackle.

Order No.	Description	List Price
7-0020	1-1/4"	\$6.39 G0-8240000
7-0022	1-1/2"	\$9.59 G0-3460000
7-0024	2"	\$13.49 G0-4090000

Electronics

Trolling Motors

Instruments

Electrical

Lighting

Anchor & Dock

Safety

Steering, Controls

Pumps

Fuel System

Seating & Pedestals

Trailering

Tops & Covers

Perform.

Propellers

Engine & Care

Cleaning & Care

Paint & Paint Acc.

Fun & Flotation

Topside Acc.

Cockpit & Deck

Hardware, Fasteners

Camouflage

Misc.

Comm.