

# Catálogo de accesorios Náuticos



Perform.



Propellers



Engine  
& Care



Cleaning  
& Care



Paint &  
Paint Acc.



Fun &  
Flotation



Topside  
Acc.



Cockpit  
& Deck



Hardware,  
Fasteners



Camouflage



Misc.



Comm.



Parte 2

# 2021

El Navegante

[www.repuestoselnavegante.com](http://www.repuestoselnavegante.com)



- Trolling Motors
- Instruments
- Electrical
- Lighting
- Anchor & Dock
- Safety
- Steering, Controls
- Pumps
- Fuel System
- Seating & Pedestals
- Trailer
- Tops & Covers
- Perform.
- Propellers
- Engine & Care
- Cleaning & Care
- Paint & Paint Acc.
- Fun & Flotation
- Topside Acc.
- Cockpit & Deck
- Hardware, Fasteners
- Camouflage
- Misc.
- Comm.

## Bienvenidos a Repuestos El Navegante.

Aquí podrás encontrar mas de **35.000** productos de diferentes fabricantes, con una gran variedad de accesorios y componentes para tu embarcación, contamos con mas de 20 años de experiencia en el sector náutico, no dudes en contactarnos para aclarar cualquier duda que tengas, prestamos asesoría técnica lo que es un valor agregado, y te dará tranquilidad a la hora de tomar una decisión de compra.

### Nota Importante:

Debido a las restricciones causadas por el Covid 19, y otros problemas a nivel Mundial muchas empresas se vieron afectadas debido a la falta de materia prima, por este motivo tanto los precios como las fechas de entrega sufrieron cambios en gran cantidad de productos, comuníquese con nosotros a través del correo: [repuestoselnavegante@gmail.com](mailto:repuestoselnavegante@gmail.com) y solicite su presupuesto sin compromiso, también puede comunicarse vía Telegram o WhatsApp escaneando los códigos QR.

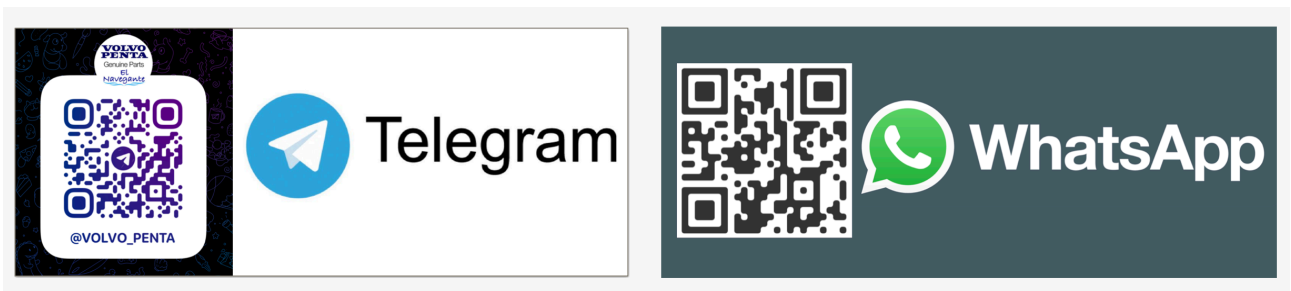

Los productos aquí publicados se encuentran en varias partes del mundo, pero la mayoría se encuentran en Estados Unidos y Europa, por lo que estos precios no incluyen gastos de envío.

También puede consultar en nuestra pagina [www.repuestoselnavegante.com](http://www.repuestoselnavegante.com) nuestros términos y condiciones antes de efectuar la compra, ahí podrá ver también nuestra política de devoluciones.

Los productos pueden ser entregados en un currier de su confianza.

En nuestra pagina podrá encontrar mas de **3.500** productos para entrega inmediata.

Nos especializamos en repuestos Volvo Penta, Cummings, Yanmar, Caterpillar, Mercruiser.

Ofrecemos repuestos para Generadores Onan, Kohler, Westerbeke, Fisher Panda y Northern Lights.

**Taco Marine Flexible Black Vinyl Rub Rails**

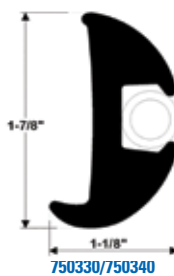

- Easy handling makes these rub rails a good choice for Do-It-Yourself boaters.
- Soft durometer provides cushion effect to absorb impact.
- Tight radius bending accomplished with minimal heating.

Order No.	Mfg. No.	Length	Use Vinyl Insert	List Price	
750302	(V11-0809BKA)	50'	V12-0810 or 3/8" Rope	\$150.09	FO-6050100
750326	(V11-3447BKA)	50'	750542 (V12-0003) or 1/2" Rope	\$210.49	FO-4374100
750330	(V112423BKA50)	50'	750542 (V12-0003) or 1/2" Rope	\$334.09	FO-6833200
750340	(V112423BKA70)	70'	750542 (V12-0003) or 1/2" Rope	\$432.59	FO-1820300

**FLEXIBLE VINYL INSERT - DIAMETER 1/2", LENGTH 70'**

Order No.	Mfg. No. / Description	List Price	
750542	(V120003BKA70) Black	\$78.99	FO-9255000

**Taco Marine Black Nylon End Caps**



- Durable black nylon.
- Caps rub rail to finish end of rail and ensure inserts stay intact. Uses screw #8.
- Sold in pairs.

**FOR RUB RAIL 750326 (V11-3447) & V21-9659**

Order No.	Mfg. No. / Description	List Price	
750718	(F90-0002BKN1)	\$21.09	FO-6741000

**FOR RUB RAIL 750340 (V11-2423) & V11-3426**

Order No.	Mfg. No. / Description	List Price	
750720	(F90-0001BKN1)	\$27.39	FO-7191000

**Taco Marine Black Rub Rail Kits**



- Kits include: Rub rail, insert, end caps and screws.

**BLACK FLEXIBLE VINYL RUB RAIL KITS**

Order No.	Mfg. No.	Dimensions	Insert Color	List Price	
751001	(V11-0809BWK5)	1-1/16" H x 11/16" W x 50' L	White	\$255.09	FO-6587100
751025	(V11-3447BWK5)	1-1/4" H x 15/16" W x 50' L	White	\$338.89	FO-2273200
751013	(V11-2423BBK5)	1-7/8" H x 1-1/16" W x 50' L	Black	\$446.89	FO-2821300
751030	(V11-3426BBK7)	1-7/8" H x 1-3/8" W x 70' L	Black	\$621.69	FO-8153400

**BLACK SEMI-RIGID VINYL RUB RAIL KITS**

Order No.	Mfg. No.	Dimensions	Insert Color	List Price	
751037	(V11-4135BKA3)	1-7/8" H x 3/4" W x 30' L	No Insert	\$246.99	FO-9827100
751040	(V119795BBK50)	1-1/2" H x 3/4" W x 50' L	Black	\$406.29	FO-0448200



Semi-Rigid Vinyl Rub Rail Kit



Flexible Vinyl Rub Rail Kit

**Taco Marine Rigid Vinyl Rub Rail with No Insert**



- Ideal for work boats.
- Designed for use without an insert.
- Provides basic protection.
- Drilled and countersunk for #10 screw on 6" centers.
- Length 20'.

Order No.	Mfg. No. / Description	List Price	
750545	(V21-3671BKA2) Black	\$120.49	FO-4348000

**Taco Marine Aluminum Rub Rail**

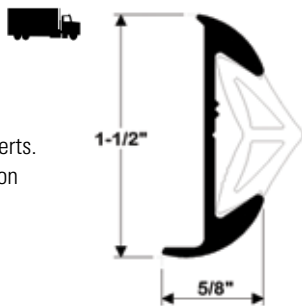

- Polished, clear anodized finish.
- Designed for use with flexible vinyl inserts.
- Drilled and countersunk for #8 screws on 6" centers.
- Use insert V12-0338.
- Height 1-1/2", width 5/8".
- Length 12'.

Order No.	Mfg. No. / Description	List Price	
749157	(A11-0638TAL)	\$94.69	FO-8266000

**Taco Marine Stainless Steel Hollow Back Rub Rails**



- Type 304 marine grade stainless steel.
- Polished mirror finish.
- Concave back design fits rigid vinyl rub rail.
- Drilled and countersunk on 6" centers.
- Length 12'.

Order No.	Mfg. No.	Width	Gauge	Screw #	List Price	
747709	(S11-4511P12)	3/4"	.062"	Screw #8	\$60.29	FO-0224000
747723	(S11-4650P12')	1"	.077"	Screw #10	\$90.09	FO-6036000

**Taco Marine Flexible Black Vinyl Inserts for Aluminum Rub Rail**

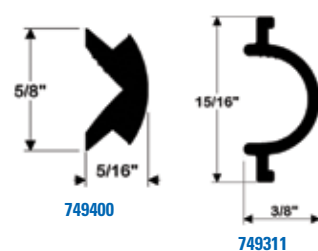

- For use with aluminum rub rails.
- Soft PVC insert provides cushion effect to absorb impact.
- Length 50'.

Order No.	Mfg. No. / Description	List Price	
749311	(V12-0317BKA) For Alum. Rub Rail A11-0317	\$117.79	FO-5428000
749400	(V12-0342BKA) For Alum. Rub Rail A11-0342	\$70.39	FO-7294000



**SPECIAL HANDLING MAY APPLY**



- Electronics
- Trolling Motors
- Instruments
- Electrical
- Lighting
- Anchor & Dock
- Safety
- Steering, Controls
- Pumps
- Fuel System
- Seating & Pedestals
- Trailer
- Tops & Covers
- Perform.
- Propellers
- Engine & Care
- Cleaning & Care
- Paint & Paint Acc.
- Fun & Flotation
- Topside Acc.
- Cockpit & Deck
- Hardware, Fasteners
- Camouflage
- Misc.
- Comm.



**Barbour Plastics Rub Rails**

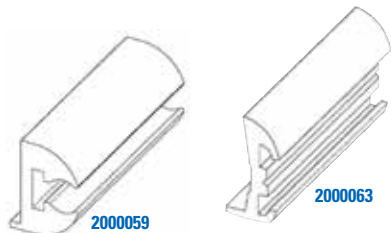

- Black flex vinyl.

**RUB RAIL - LENGTH 50'**

Order No.	Mfg. No. / Description	List Price	
2000059	(AL-2015) Flex Base Rub Rail	\$275.09	F0-6529100
2000063	(AL-2235-R) Rigid Base Rub Rail	\$193.29	F0-0353100

**Radial 30 Rub Rail Kits**



- Fast and easy to install, Radial is the PVC fender profile without rivals.
- It's different from all other profiles on the market and can be cold fitted in just a few steps.
- The soft insert is supplied in custom cut reels, to avoid waste and unsightly seams.
- Easy to install with seamless, Italian style.
- 1-1/8".
- Includes: 46' complete profile, (2) end caps and (1) joint cap.

Order No.	Mfg. No. / Description	List Price	
866100	(T130-141-004) White	\$182.39	G0-0222100
866105	(T130-141-004) Black	\$182.39	G0-0222100

**T-H Marine Rub Rail End Caps**



- Molded black plastic.
- Designed to fit rubber rail molding.
- This unit attaches with screw through the vinyl or rope trim to prevent trim from slipping out.
- UV stable, chemical resistant and corrosion proof molded caps provide attractive and long lasting service.
- Sold per pair.

Order No.	Mfg. No. / Description	List Price	
640064	(ECR-1-DP) For 1-1/2" Wide Molding	\$9.39	H0-3650000
6400139	(ECR-2-DP) For 1-3/4" Wide Molding	\$9.39	H0-3650000

**Barbour Plastics Flex Inserts**

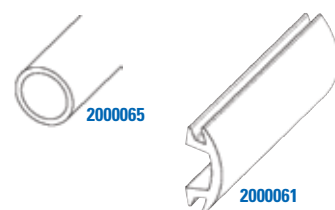

- Black flex vinyl.

**INSERT - LENGTH 50'**

Order No.	Mfg. No. / Description	List Price	
2000061	(AL-2029) Flex Insert for 2000063	\$113.19	F0-3297000
2000065	(AL-2713-F) Flex Tube Insert for 2000059	\$80.19	F0-3165000

**Radial 40 Rub Rail Kits**



- Fast and easy to install, Radial is the PVC fender profile without rivals.
- It's different from all other profiles on the market and can be cold fitted in just a few steps.
- The soft insert is supplied in custom cut reels, to avoid waste and unsightly seams.
- Easy to install with seamless, Italian style.
- 1-5/8".
- Includes: 52' complete profile, (2) end caps and (1) joint cap.

Order No.	Mfg. No. / Description	List Price	
866110	(T130-140-110) White	\$311.39	G0-3680200
866115	(T130-140-110) Black	\$311.39	G0-3680200

**T-H Marine Rub Rail Splices**



- Molded black plastic.
- Designed to fit both aluminum and rubber rail molding.
- This unit attaches with screws through the vinyl or rope trim to prevent trim from slipping out.
- UV stable, chemical resistant and corrosion proof molded caps provide attractive and long lasting service.
- Butt splice for 1-1/4" to 1-1/2" rub rail, 2-1/4" long.
- Sold per pair.

Order No.	Mfg. No. / Description	List Price	
6400278	(SR1DP)	\$8.39	H0-3050000

**Taco Marine Flexible Vinyl Trim - Self-Locking**

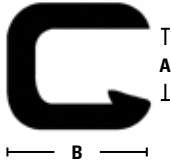

- Made of flexible PVC.
- Covers unfinished edges and follows almost any contour or radius.
- Integrated interior aluminum clip and gripping tongue ensures a better fit.
- Packaged 25' length per box.

**BLACK**

Order No.	Mfg. No.	Opening	Flex Trim	List Price	
623635	(V301005B25-1)	5/32"	9/16"	\$71.99	F0-9305000
623637	(V301008B25-1)	1/4"	1/2"	\$60.69	F0-8424000
623639	(V301312B25-1)	3/8"	5/8"	\$102.69	F0-8817000

**WHITE**

Order No.	Mfg. No.	Opening	Flex Trim	List Price	
623636	(V301005W25-1)	5/32"	9/16"	\$60.69	F0-8424000
623638	(V301008W25-1)	1/4"	1/2"	\$65.39	F0-7754000

**Trim-Lok U-Channel Edging**

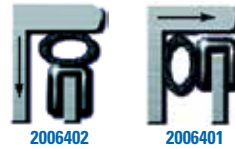

- The original "Trim Lok" gives a beautiful finished look! Just push it on and its on to stay...no stapling or glue... Saves on labor...grips on difficult materials, compound curves, etc..
- Rubber-Lok has individual metal clips inside that provide a secure grip.
- Comes with an aluminum inner core for corrosion resistance, light weight.
- Finish is textured for appearance.
- Accommodates edges up to 3/16".
- Sold by the linear foot. Cut to order (Not all locations).

Order No.	Mfg. No. / Description	List Price	
2006401	(6100A) Black With Side Seal	\$5.99	H0-9530000
2006402	(6100C) Black With Top Seal	\$5.99	H0-9530000
2006403	(TL) Black No Seal	\$1.99	H0-9110000
2006404	(TL-W) White No Seal	\$2.69	H0-1610000

**Standard Products Vinyl Trim - Self-Locking**

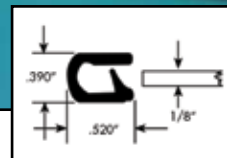
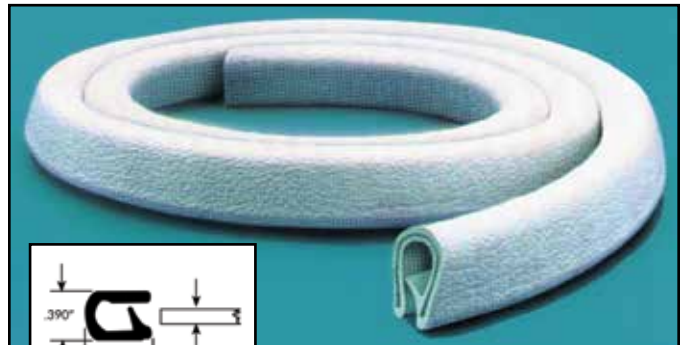

- Flexible embossed vinyl aluminum core QuickEdge trim.
- Standard single lip trim for 1/8" to 3/16" edges.
- Grips edges from .090" to .190" thick.
- Priced per foot. Sold 200' rolls only. One box = Two rolls (400').

Order No.	Mfg. No. / Description	List Price	
623643	(75000346) White	\$2.19/ft.	H0-1310000
623644	(75000348) Black	\$1.99/ft.	H0-9110000

**Taco Marine Aluminum T-Hatch Trim**



- Polished, clear anodized finish.
- Ideal for hatches.
- Height 3/4", width 1-1/8".
- Length 12'.

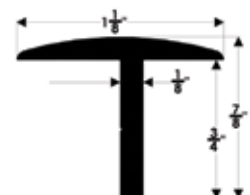

Order No.	Mfg. No. / Description	List Price	
748460	(A50-0304TAL)	\$107.89	F0-2557000



**SPECIAL HANDLING MAY APPLY**



- Electronics
- Trolling Motors
- Instruments
- Electrical
- Lighting
- Anchor & Dock
- Safety
- Steering, Controls
- Pumps
- Fuel System
- Seating & Pedestals
- Trailering
- Tops & Covers
- Perform.
- Propellers
- Engine & Care
- Cleaning & Care
- Paint & Paint Acc.
- Fun & Flotation
- Topside Acc.
- Cockpit & Deck
- Hardware, Fasteners
- Camouflage
- Misc.
- Comm.

- Electronics
- Trolling Motors
- Instruments
- Electrical
- Lighting
- Anchor & Dock
- Safety
- Steering, Controls
- Pumps
- Fuel System
- Seating & Pedestals
- Trailering
- Tops & Covers
- Perform.
- Propellers
- Engine & Care
- Cleaning & Care
- Paint & Paint Acc.
- Fun & Flotation
- Topside Acc.
- Cockpit & Deck
- Hardware, Fasteners
- Camouflage
- Misc.
- Comm.

**Perko Figs. 918 Rim Lock Set**



- Chrome plated zinc alloy.
- Regular bevel with box strike.
- Locks by turn button from inside or key from outside.
- For door thickness: 5/8" to 1-3/8".
- Dimensions case: 3-7/8" x 2".
- Dimensions escutcheon: 4-3/8" x 1-1/4".
- Uses #6 fasteners.
- Complete with two keys.

Order No. **543517** Mfg. No. / Description (0918 DPO CHR) List Price **\$163.39** GO-7490100

**Perko Fig. 930 Rim Latch Set**



- Chrome plated zinc alloy.
- Sliding lock button.
- Reverse bevel with flush strike.
- For door thickness: 5/8" to 1-3/8".
- Dimensions case: 2-1/8" x 1-3/4".
- Dimensions escutcheon: 4-3/8" x 1-1/4".
- Uses #6 fasteners.

Order No. **543644** Mfg. No. / Description (0930 DPO CHR) List Price **\$92.69** GO-0126000

**Perko Fig. 927 Mortise Lock Set**



- Chrome plated zinc alloy.
- Locked by turn button from inside or key from outside.
- Bevel can be reversed during installation.
- For door thickness: 1" to 1-3/8".
- Dimensions case: 2-3/4" x 2".
- Dimensions escutcheon: 4-3/8" x 1-1/4".
- Uses #6 fasteners.
- Complete with two keys.

Order No. **543606** Mfg. No. / Description (0927 DPO CHR) List Price **\$148.79** GO-9699000

**Perko Fig. 921 Flush Lock and Latch**



- Chrome plated zinc alloy.
- Lock with 2 keys.
- For door thickness 1/2" to 3/4".
- Installs in a 1-5/8" diameter hole.
- Face plate dimensions: 2-1/4" x 2".

Order No. **543531** Mfg. No. / Description (0921 DPO CHR) List Price **\$51.79** GO-0743000

**Perko Fig. 928 Rim Latch Set**



- Chrome plated zinc alloy.
- Sliding lock button.
- Regular bevel with box strike.
- For door thickness: 5/8" to 1-3/8".
- Dimensions case: 2-1/8" x 1-3/4".
- Dimensions escutcheon: 4-3/8" x 1-1/4".
- Uses #6 fasteners.

Order No. **543618** Mfg. No. / Description (0928 DPO CHR) List Price **\$92.69** GO-0126000

**Perko Fig. 567 Tubular Latch Set**



- Chrome plated zinc alloy.
- Sliding lock button.
- For door thickness 1" to 1-3/8".
- Dimensions case: 4-3/8" x 1-1/4".
- Tube OD 3/4".
- Uses #6 fasteners.

Order No. **540977** Mfg. No. / Description (0567 DPO CHR) List Price **\$109.19** GO-6137000

**Perko Fig. 960 Mortise Latch Set**



- Chrome plated zinc alloy.
- Turn button lock.
- Bevel can be reversed during installation.
- For doors thickness: 1" to 1-3/8".
- Dimensions case: 2-1/4" x 1-13/16".
- Dimensions escutcheon: 4-3/8" x 1-1/4".
- Uses #6 fasteners.

Order No. **543973** Mfg. No. / Description (0960 DPO CHR) List Price **\$97.19** GO-2156000



Perko Figs. 931 and 932 Flush Lock and Latches



- Chrome plated zinc alloy.
- Black polymer with stainless steel stem and lock nut.
- For door thickness 1/4" to 1-1/8".
- Installs in a 2" diameter hole.
- Face plate dimensions: 2-1/2" x 2-1/2".
- Adjustment cam bar: 3/8" to 3".

WITH OFFSET CAM BAR AND FLEXIBLE POLYMER STRIKE

Order No.	Mfg. No. / Description	List Price	
543648	(0931 DP1 BLK) Lock with 2 Keys	\$48.19	G0-9223000
543632	(0932 DP1 BLK) Latch, Non-Locking	\$39.19	G0-6262000

WITH OFFSET ADJUSTABLE CAM BAR

Order No.	Mfg. No. / Description	List Price	
5315155	(0931 DP2 BLK) Lock with 2 Keys	\$48.19	G0-9223000
543640	(0932 DP2 BLK) Latch, Non-Locking	\$39.19	G0-6262000

REPLACEMENT CAM BARS

Order No.	Mfg. No. / Description	List Price	
543649	(0931 001 99A) Offset Cam Bar	\$18.49	G0-9321000
5315151	(0931 002 99A) Offset Adjustable Cam Bar	\$23.89	G0-1061000
5315152	(0931 003 99A) Straight Cam Bar	\$18.49	G0-9321000

Perko Figs. 1091 "T" Handle Surface Mount Locks and Latches



- Black polymer body.
- Chrome plated zinc alloy "T" handle.
- Stainless steel stem.
- Gasket included for smooth surface applications.
- Toothed back for carpet surface applications.
- Face plate diameter: 3".
- Installs in a 2-1/2" diameter hole for mounting surfaces 1/8" to 3/4" thick.

WITH OFFSET CAM BAR ADJUSTS 3/4" TO 2-3/8"

Order No.	Mfg. No. / Description	List Price	
536520	(1091 DP1 BLK) Lock with 2 Keys	\$54.09	G0-4263000
5315035	(1092 DP1 BLK) Latch, Non-Locking	\$44.89	G0-8003000

WITH STRAIGHT CAM BAR ADJUSTS 1-1/4" TO 1-7/8"

Order No.	Mfg. No. / Description	List Price	
5315033	(1091 DP3 BLK) Lock with 2 Keys	\$50.29	G0-9633000
5315036	(1092 DP3 BLK) Latch, Non-Locking	\$44.89	G0-8003000

White Cap T-Handle Latches



- Black nylon.
- Diameter 3".
- Cut-out: 2-1/2".
- Surface depth: 1/8" - 3/4".
- Includes: Neoprene O-ring, key and fastener.
- Note: Must order cam bar separately!

WITH CHROME PLATED ZAMAC T-HANDLE

Order No.	Mfg. No. / Description		List Price	
2011596	(S-0226B) Locking	No Cam Bar	\$36.69	H0-1022000
2011603	(S-0230B) Non-Locking	No Cam Bar	\$30.89	H0-3581000

WITH BLACK NYLON T-HANDLE

Order No.	Mfg. No. / Description		List Price	
2011610	(3226BC) Locking	No Cam Bar	\$47.19	H0-1382000
2011611	(3230B) Non-Locking	No Cam Bar	\$26.59	H0-5951000

T-HANDLE CAM BARS

- Zinc cam bar.
- Cam ONLY!
- Order T-handle latches separately.

Order No.	Mfg. No. / Description		List Price	
2011597	(S-0226LO) Offset-Long, 2-7/8" L		\$5.09	H0-5030000
2011598	(S-226LOSTR) Offset-Long Star w/Opening, 2-7/8" L		\$6.59	H0-5930000
2011599	(S-0226SO) Offset-Short, 2-1/4" L		\$5.29	H0-7130000
2011600	(S-0226A) Straight-Long, 2-5/8" L		\$5.89	H0-3530000
2011601	(S-0226ASTR) Straight-Long Star w/Opening, 2-5/8" L		\$4.89	H0-3920000
2011602	(S-226SL) Straight-Short, 1-7/8" L		\$5.79	H0-7430000

T-H Marine Anchor Handle Locks



- Fits aluminum, fiberglass and carpeted lids.
- Sure grip two-finger handle.
- Waterproof O-ring seal.
- Stainless steel stem.
- Single hex nut installation.
- Gasket included for smooth surface applications.
- Toothed and "Double-D" shaped mounting for carpeted lids.
- Powder coated steel pawls - straight and offset.
- Mounts in lids up to 3/4" thick. Installs into a 2-3/8" to 2-1/2" hole.
- Universal replacement for all T-H Marine or Perko.

Order No.	Mfg. No. / Description	List Price	
639802	(ALC-2-DP) White Base with Chrome Handle	\$43.19	H0-1952000
639804	(ALC-1-DP) Black Base with Chrome Handle	\$42.79	H0-7652000
639806	(AL-1-DP) Black Base with Black Handle	\$41.49	H0-9842000

- Electronics
- Trolling Motors
- Instruments
- Electrical
- Lighting
- Anchor & Dock
- Safety
- Steering, Controls
- Pumps
- Fuel System
- Seating & Pedestals
- Trailering
- Tops & Covers
- Perform.
- Propellers
- Engine & Care
- Cleaning & Care
- Paint & Paint Acc.
- Fun & Flotation
- Topside Acc.
- Cockpit & Deck
- Hardware, Fasteners
- Camouflage
- Misc.
- Comm.

- Electronics
- Trolling Motors
- Instruments
- Electrical
- Lighting
- Anchor & Dock
- Safety
- Steering, Controls
- Pumps
- Fuel System
- Seating & Pedestals
- Trailering
- Tops & Covers
- Perform.
- Propellers
- Engine & Care
- Cleaning & Care
- Paint & Paint Acc.
- Fun & Flotation
- Topside Acc.
- Cockpit & Deck
- Hardware, Fasteners
- Camouflage
- Misc.
- Comm.

**Marpac Stainless Steel Push to Close Latches**



- Stainless steel face and pull.
- Corrosion resistant materials.
- Flush mount.
- Pull to open.
- Single, round-hole installation.
- Inside actuation when locked or unlocked.

**NON-LOCKING LATCHES**

Order No.	Description	Cutout Size:	List Price	
7-2267	1-3/4" OD	1-3/8"	\$27.19	GO-2281000
7-2270	2-3/8" OD	2"	\$33.69	GO-7522000

**LOCKING LATCH**

Order No.	Description	Cutout Size:	List Price	
7-2271	2-3/8" OD	2"	\$43.19	GO-4982000

**Marpac Push to Close Latches**



- Pull to open.
- Corrosion resistant materials.
- Single, 2" diameter round-hole installation.
- Fits panels .475" to .675" thick.

Order No.	Description	Color	List Price	
7-2260	Black		\$8.89	GO-6950000
7-2261	White		\$8.89	GO-6950000

**Marpac Stainless Steel Lift & Turn Latches**



- Cast stainless steel.
- 180° turn and close capability.

Order No.	Description	Cutout Size:	List Price	
7-1370	3" OD	2-1/2"	\$78.59	GO-6625000
7-1371	2-1/2" OD	2"	\$46.99	GO-8413000

**Marpac Push to Close Latch**



- Pull to open.
- Corrosion resistant materials.
- Single, 2" diameter round-hole installation.
- Fits panels .475" to .675" thick.

Order No.	Description	Color	List Price	
7-2265	Black		\$27.89	GO-9681000

**T-H Marine Nautical Slam Latch**



- Oval top, nautical design.
- Low profile.
- Totally corrosion resistant.
- UV stable.
- Resistant to chemicals including acetone, alcohol, gasoline, etc.
- Stainless steel pawl catch, mounting hardware and striker plate.
- Simple installation in a 2" round hole.
- Fits 1-1/16" to 7/8" lids.

Order No.	Mfg. No. / Description	Color	List Price	
641085	(NFSL-5-1-DP) Black		\$24.09	H0-5441000





Freshwater Exclusive



Saltwater Exclusive

Perko Fig. 1177 Door Stop



- Chrome plated zinc alloy.
- Rubber bumper.
- Length 1".
- 1-1/4" OD.
- Uses #4 fasteners.

Order No. Mfg. No. / Description List Price  
**532906** (1177 DPO CHR) **\$9.89** GO-3660000

Perko Fig. 1216 Door Button with Spring



- Chrome plated zinc alloy.
- Black polymer button.
- Supplied with phosphor bronze tension spring.
- 1-3/4" OD.
- Uses #6 fasteners.

Order No. Mfg. No. / Description List Price  
**533364** (1216 DPO CHR) **\$13.49** GO-4090000

Perko Fig. 574 Door Stop and Holder



- Chrome plated bronze.
- Rubber bumper.
- Dimensions: 3-1/4" L x 1-3/4" O.D.

Order No. Mfg. No. / Description List Price  
**534068** (0574 DP2 CHR) **\$111.39** GO-3647000

T-H Marine Anti-Rattle Pontoon Gate Door Stops



- Injection molded pontoon gate door stop.
- Stops gate rattle.
- Requires no welding.
- Simple installation with one #10 screw.
- Gray.

WITH RIBS FOR 1-1/4" TUBING

Order No. Mfg. No. / Description List Price  
**6400127** (DS-1L-DP) Left Hinge **\$5.59** HO-5330000  
**6400128** (DS-1R-DP) Right Hinge **\$5.59** HO-5330000

WITHOUT RIBS - UNIVERSAL FIT

Order No. Mfg. No. / Description List Price  
**6400129** (DS-2L) Left Hinge **\$4.09** HO-5420000  
**6400130** (DS-2R) Right Hinge **\$4.09** HO-5420000

T-H Marine Pontoon Gate Latches



- Nylon molded part - prevents rattle.
- Operates on right or left hinged gates.
- Fits 1", 1-1/8" and 1-1/4" square tubing.
- Prevents gate from swinging inward.
- All parts install on gate only.

Order No. Mfg. No. / Description List Price  
**247750** (GL-1-DP) Black **\$17.49** HO-9401000  
**247751** (GL-2-DP) Gray **\$17.49** HO-9401000



Perko Fig. 1056 Elbow Catch



- Chrome plated zinc alloy with stainless steel spring.
- Dimensions: 1-1/8" x 9/16".
- Uses #6 fasteners.

Order No. Mfg. No. / Description List Price  
**531675** (1056 DPO CHR) **\$15.69** GO-1501000

- Electronics
- Trolling Motors
- Instruments
- Electrical
- Lighting
- Anchor & Dock
- Safety
- Steering, Controls
- Pumps
- Fuel System
- Seating & Pedestals
- Trailering
- Tops & Covers
- Perform.
- Propellers
- Engine & Care
- Cleaning & Care
- Paint & Paint Acc.
- Fun & Flotation
- Topside Acc.
- Cockpit & Deck
- Hardware, Fasteners
- Camouflage
- Misc.
- Comm.

**Marpac Stainless Steel Ball Catch**



- Heavy duty cast type 316 marine grade stainless steel.
- Dimensions: 2" W x 3/8" H.

Order No.	Description	List Price	
7-0221	Ball Catch	\$14.89	G0-8990000

**Marpac Plastic Door Latches**



- Set includes one male and one female.
- Uses #6 fasteners.
- Sold 3 sets per card.

Order No.	Description	List Price	
7-0220	Plastic Door Latch	\$6.99	G0-8640000

**Perko Fig. 554 Door Catch**



- White polymer.
- Stainless steel mounting and keeper screws.
- Catch dimensions: 1-1/4" x 5/8".
- Catch screw size 3/4" x #8.
- Uses #4 R.H. fasteners.
- Sold 2 per pack.

Order No.	Mfg. No. / Description	List Price	
540837	(0554 DP)	\$10.49	G0-3070000

**Perko Fig. 559 Door Catch**



- Black polymer ball stud and socket.
- Stud dimensions: 1-1/8" x 3/8".
- Socket dimensions: 1-3/8" x 7/8".
- Uses #4 R.H. fasteners.
- Sold 2 per pack.

Order No.	Mfg. No. / Description	List Price	
540838	(0559 DP)	\$6.99	G0-8640000

**Perko Fig. 1065 Door Holder**



- Stainless steel clip has 1-3/8" x 7/16" base.
- Chrome plated zinc alloy arrow has 1-5/8" x 3/4" base.
- Projects 1-3/4".
- Uses #8 fasteners.
- Sold 1 per card, 5 cards per box.

Order No.	Mfg. No. / Description	List Price	
531764	(1065 DPO CHR)	\$25.79	G0-8271000

**Perko Fig. 956 Cabin Door Hooks**



- Chrome plated cast bronze.
- Sold 1 per card, 5 cards per box.

Order No.	Mfg. No.	Length	List Price	
547337	(0956 DP4 CHR)	3"	\$34.99	H0-9902000
547349	(0956 DP6 CHR)	4"	\$49.09	G0-9823000
547363	(0956 DP8 CHR)	6"	\$62.19	H0-1373000

**Perko Fig. 1199 Cabin Door Hooks**



- Chrome plated zinc alloy.
- Lightweight design.
- Uses #6 fasteners.
- Sold 1 per card.

Order No.	Mfg. No.	Length	List Price	
533263	(1199 DP1 CHR)	1-3/4"	\$11.59	G0-7770000
533249	(1199 DP2 CHR)	2-1/4"	\$12.59	G0-4480000
533251	(1199 DP3 CHR)	3"	\$12.89	G0-4680000

**Perko Fig. 1287 Cabin Door Hooks**



- Chrome plated zinc alloy.
- Modern design.
- Uses #6 fasteners.
- Sold 1 per card.

Order No.	Mfg. No.	Length	List Price	
534037	(1287 DP1 CHR)	2"	\$11.59	G0-7770000
534051	(1287 DP2 CHR)	2-1/2"	\$12.49	G0-7380000
534063	(1287 DP3 CHR)	3"	\$13.09	G0-7780000

**Perko Fig. 1101 Cupboard Bolt**



- Chrome plated zinc alloy.
- Black polymer slide and knob.
- Overall dimensions: 2-1/8" x 1-1/2".
- Uses #6 fasteners.

Order No.	Mfg. No. / Description	List Price	
531928	(1101 DPO CHR)	\$25.99	G0-1471000

**Perko Fig. 1102 Cupboard Catches**



- Chrome plated zinc alloy.
- Overall dimensions: 1-1/2" x 1-7/8".
- Uses #6 fasteners.

Order No.	Mfg. No. / Description	List Price	
531942	(1102 001 CHR) Box Strike	\$39.29	H0-7532000
531954	(1102 002 CHR) 3/8" Box Strike	\$39.29	H0-7532000
531957	3/16" Spacers for 531954	\$3.19	H0-1910000

**Perko Fig. 1053 Ship Bolt**



- Chrome plated bronze.
- Includes brass friction spring to eliminate rattle and provide detented operation.
- Overall dimensions: 2-5/8" x 1-1/4".
- Uses #6 fasteners.

Order No.	Mfg. No. / Description	List Price	
531649	(1053 DPO CHR)	\$52.79	G0-7353000

**Perko Fig. 947 Barrel Bolts**



- Chrome plated bronze body and high impact black nylon bulkhead keeper.
- 3/8" Diameter bolt.
- Bulkhead keeper easily installs in a 5/8" hole.
- Includes friction pad to eliminate rattle and provide smooth operation.
- Includes both styles of keepers.
- Uses #6 fasteners.

Order No.	Mfg. No. / Description	List Price
547298	(0947 DP1 CHR) Overall Dim.: 3-7/16" x 1-7/16"	\$53.09 G0-7553000
543808	(0947 DP2 CHR) Overall Dim.: 4-5/16" x 1-7/16"	\$46.19 G0-5903000
543535	(0947 DP3 CHR) Overall Dim.: 5-1/4" x 1-7/16"	\$56.79 G0-5083000

**Marpac Stainless Steel Lift Ring**



- Polished 304 stainless steel.
- Surface mount installation.
- Dimensions: 2-1/8" x 1-15/16".

Order No.	Description	List Price
7-0084	Lift Ring	\$4.49 G0-1030000

**Marpac Stainless Steel Flush Lifting Handle**



- Polished stainless steel.
- Dimensions: 2-1/4" x 3".
- Uses #8 fasteners.

Order No.	Description	List Price
7-0085	Flush Lifting Handle	\$6.89 G0-2640000

**Perko Fig. 776 Flush Lifting Handles**

- Chrome plated bronze.
- Uses #8 fasteners.

**FIG. 776 FLUSH LIFTING HANDLE**

- Face plate dimensions: 3" x 2-1/4".
- Inside handle dimensions: 1-7/8" x 1".

Order No.	Mfg. No. / Description	List Price
542185	(0776 DP1 CHR)	\$63.29 G0-0424000

**FIG. 776 FLUSH LIFTING HANDLE - MOUNTING HOLES AT CORNERS**

- Face plate dimensions: 3-3/4" x 2-3/4".
- Inside handle dimensions: 2-3/16" x 1-3/16".

Order No.	Mfg. No. / Description	List Price
542197	(0776 DP2 CHR)	\$81.89 G0-7845000

**Marpac Barrel Bolts**



- Precision cast stainless steel.

Order No.	Description	List Price
7-0409	Dimensions: 3-1/2" x 1-1/2"	\$23.99 G0-7061000
7-0410	Dimensions: 4-1/2" x 1-1/2"	\$23.79 G0-4951000

**Perko Fig. 1051 Flush Ring Catch**



- Chrome plated zinc alloy.
- Phosphor bronze spring.
- Dimensions: 2-1/4" x 1-3/8".
- Uses #6 fasteners.

Order No.	Mfg. No. / Description	List Price
531637	(1051 DP0 CHR)	\$26.89 G0-2081000

**Marpac Locking Lift Ring**



- Keep valuables protected with this easy to install lock.
- Includes regular and offset cams.
- Dimensions: 2-1/8" x 1-15/16".

Order No.	Description	List Price
7-54205	2 Keys	\$10.19 G0-3860000

**Perko Fig. 1220 Flush Lifting Handle**



- Chrome plated zinc alloy.
- Face plate dimensions: 3" x 2-1/4".
- Inside handle dimensions: 1-7/8" x 1".
- Uses #8 fasteners.

Order No.	Mfg. No. / Description	List Price
533427	(1220 DP0 CHR)	\$19.89 G0-3331000

- Electronics
- Trolling Motors
- Instruments
- Electrical
- Lighting
- Anchor & Dock
- Safety
- Steering, Controls
- Pumps
- Fuel System
- Seating & Pedestals
- Trailering
- Tops & Covers
- Perform.
- Propellers
- Engine & Care
- Cleaning & Care
- Paint & Paint Acc.
- Fun & Flotation
- Topside Acc.
- Cockpit & Deck
- Hardware, Fasteners
- Camouflage
- Misc.
- Comm.



**Perko Fig. 841 Flush Ring Pull**



- Chrome plated zinc alloy.
- Face plate dimensions: 1-3/4" x 1-3/8".
- Uses #6 fasteners.

Order No. Mfg. No. / Description List Price  
**542490** (0841 DPO CHR) **\$15.29** G0-4201000

**Perko Fig. 1103 Flush Ring Pull**



- Chrome plated bronze.
- Face plate dimensions: 2-9/16" x 2".
- Uses #8 fasteners.

Order No. Mfg. No. / Description List Price  
**531978** (1103 DPO CHR) **\$45.89** G0-5703000

**Perko Fig. 575 Flush Ring Pull**



- Chrome plated bronze.
- Face plate dimensions: 2-5/8" x 2".
- Uses #8 fasteners.

Order No. Mfg. No. / Description List Price  
**541044** (0575 DPO CHR) **\$45.99** G0-1803000

**White Cap Flush Pull Ring**



- Chrome plated.
- Maintains a flush appearance and recessed for safety.
- Dimensions: 1-1/2" x 1-3/4"

Order No. Mfg. No. / Description List Price  
**2011618** (S-3360C) **\$15.69** H0-1490000

**Perko Fig. 1232 Flush Ring Pull**



- Chrome plated zinc alloy.
- Face plate 1-5/8" OD.
- Uses #6 fasteners.

Order No. Mfg. No. / Description List Price  
**533618** (1232 DP1 CHR) **\$15.19** G0-8101000

**Marpac Flush Hatch Pull**



- Injection molded and large enough to get your fingers in.
- Strong material will flex but not break when stepped on.
- Dimensions: 2-1/4" x 2-1/4".

Order No. Description List Price  
**7-54207** Flush Hatch Pull **\$3.19** G0-4120000

**T-H Marine Lid Lift Pull**



- Injection molded and large enough to get your fingers in.
- The bottom cup prevents water from entering box.
- Outside dimensions: 2-3/4" x 2-3/4".
- Hose size: 2-1/8".
- Uses (4) #6 fasteners.

Order No. Mfg. No. / Description List Price  
**642277** (LL-1-DP) Black **\$7.69** H0-1640000

**Perko Fig. 1016 Flush Pull**



- Black polymer.
- Easily installs in a 1-3/4" diameter hole.
- Face plate dimensions: 2-1/4" x 2-1/4".
- Depth 15/16".
- Uses #6 fasteners.

Order No. Mfg. No. / Description List Price  
**531550** (1016 DPO BLK) **\$3.99** G0-7620000

**T-H Marine Large Lid Lift Pull**



- Large 3-finger pull.
- Provides flush pull for opening lids and hatches.
- The bottom cup prevents water from entering box.
- Outside dimensions: 3-1/2" x 2-1/4".
- Hose size: Two each 1-1/2".

Order No. Mfg. No. / Description List Price  
**642252** (LLR-1) Black **\$4.59** H0-5720000

**Perko Fig. 958 Drawer Pull**



- Chrome plated zinc alloy.
- Overall width 3-7/16", inside width 2-5/16".
- Uses #6 fasteners.

Order No. Mfg. No. / Description List Price  
**543961** (0958 DPO CHR) **\$18.09** G0-2121000

**Marpac Stainless Steel Hatch Cover Pull**



- Type 304 stainless steel with electro-polished finish.
- Stainless steel washer and keep ring.
- Lays flat - easy to use.
- Lifting disc: 1-1/4". Stem diameter: 3/16".

Order No. Mfg. No. / Description List Price  
**7-0651** Hatch Cover Pull **\$3.39** G0-7220000

**Marpac Drawer Knob**



- Cast 316 stainless steel with 1" screw.
- Diameter 1"

Order No. Mfg. No. / Description List Price  
**7-0408** Drawer Knob **\$6.99** G0-8640000

- Electronics
- Trolling Motors
- Instruments
- Electrical
- Lighting
- Anchor & Dock
- Safety
- Steering, Controls
- Pumps
- Fuel System
- Seating & Pedestals
- Trailering
- Tops & Covers
- Perform.
- Propellers
- Engine & Care
- Cleaning & Care
- Paint & Paint Acc.
- Fun & Flotation
- Topside Acc.
- Hardware, Fasteners
- Camouflage
- Misc.
- Comm.

**Marpac Push-to-Close Latch**



- Chrome.
- Corrosion and UV resistant.
- Quick, round-hole installation.
- Knob stores flush; pops out at a touch.
- Pull the knob to open, simply push the door to close.

Order No.	Description	List Price
7-2285	Push-to-Close Latch	\$28.59 GO-6191000

**Perko Fig. 1198 Safety Hasps**



- Chrome plated zinc alloy.
- Width 1". Padlock clearance 1/4".
- Uses #6 fasteners.

**CLOSED LENGTH: 3"**

Order No.	Mfg. No. / Description	List Price
533237	(1198 DP2 CHR)	\$20.69 GO-6831000

**CLOSED LENGTH: 3-3/4"**

Order No.	Mfg. No. / Description	List Price
533227	(1198 DP3 CHR)	\$21.19 GO-0241000

**Marpac Locking Push-to-Close Latch**



- Glass reinforced black nylon.
- Corrosion resistant.
- Locking.
- Pull tab in line with latching pawl.

Order No.	Description	List Price
7-2280	Push-to-Close Latch	\$29.69 GO-9891000

**Perko Fig. 998 Safety Hasp**



- Chrome plated bronze.
- Width 1".
- Closed length: 3".
- Padlock clearance: 9/32".
- Uses #6 fasteners.

Order No.	Mfg. No. / Description	List Price
544329	(0998 DP2 CHR)	\$49.69 GO-9233000

**Marpac Swivel Lock Hasps**



- Type 304 stamped stainless steel.
- A strong versatile utility hasp with a swivel head.
- Uses #6 fasteners.

Order No.	Dimensions	List Price
7-0216	2-3/4" x 1"	\$9.19 GO-6160000
7-0218	3-1/4" x 1"	\$13.09 GO-7780000

**Perko Fig. 1194 Swivel Safety Lock Hasp**



- Chrome plated zinc alloy.
- Padlock eye swivels to act as a latch.
- Width 1". Closed length: 3".
- Padlock clearance: 11/32".
- Uses #6 fasteners.

Order No.	Mfg. No. / Description	List Price
533173	(1194 DPO CHR)	\$23.89 GO-1061000

**SPARE KEEPER, 1 PER CARD**

Order No.	Mfg. No. / Description	List Price
533174	(1194 DPO 99A)	\$12.39 GO-0380000

**Marpac 90° Angle Bracket**



- Polished stainless steel.
- Leg length 2-3/8", leg width 9/16".
- Sold per pair.

Order No.	Description	List Price
7-0411	90° Angle Bracket	\$4.89 GO-8230000

**Marpac Butt Hinges**



- Polished, stamped type 304 stainless steel.
- .060 gauge.
- Uses #8 fasteners, except 7-1009 uses #10 fasteners.
- Sold per pair.

Order No.	Description	List Price
7-1007	Open Width 2" Pin Length 2"	\$9.49 GO-6360000
7-1008	Open Width 2" Pin Length 3"	\$11.89 GO-7970000
7-1009	Open Width 3" Pin Length 3"	\$13.89 GO-1390000

**Marpac Stay-Put Hinges**



- 316 stainless steel and phosphor bronze construction for maximum corrosion resistance.
- No more limp hinges.
- Holds open hatches, live well lids, electronic box doors-stays where it's put.
- Eliminates the need for gas shocks or hatch springs in some applications.
- Patented friction technology from GEM.
- Replaces existing hinges with matching mounting holes.
- Used on over 100 boat manufacturers including: Chaparral Boats, Robalo Boats, Yellowfin Yachts, Sea Ray, Sea Hunt Boats, Tidewater Boats, Sundance Skiffs, Maverick, Cobia and Key West Boats.
- Uses #8 fasteners.
- Note: DO NOT attempt to adjust the tension of the friction hinge in any way.

Order No.	Description	List Price
7-1475	Butt Hinge 4 Hole 1-1/2" L x 1-1/2" W	\$34.09 GO-4822000
7-1479	Utility Hinge 6 Hole 3" L x 1-1/2" W	\$39.09 GO-9162000
7-1481	Butt Hinge 4 Hole 2" L x 2" W	\$38.69 GO-2952000
7-1483	Butt Hinge 6 Hole 3" L x 2" W	\$47.49 GO-2813000

- Electronics
- Trolling Motors
- Instruments
- Electrical
- Lighting
- Anchor & Dock
- Safety
- Steering, Controls
- Pumps
- Fuel System
- Seating & Pedestals
- Trailering
- Tops & Covers
- Perform.
- Propellers
- Engine & Care
- Cleaning & Care
- Paint & Paint Acc.
- Fun & Flotation
- Topside Acc.
- Cockpit & Deck
- Hardware, Fasteners
- Camouflage
- Misc.
- Comm.

**Marpac Butt Hinges**



**HEAVY DUTY, CAST STAINLESS STEEL**

- Uses #10 fasteners. Sold per pair.

Order No.	Description	List Price
7-0970	1-1/2" x 1-1/2"	\$22.79

**STAINLESS STEEL**

- Uses #8 fasteners. Sold per pair.

Order No.	Description	List Price
7-0686	1-5/16" W (Open) x 1-1/2" L	\$7.89

**Marpac Utility Hinge**



- Stamped stainless steel.
- Open width 3". Pin length 1-1/2".
- Uses #8 fasteners.
- Sold per pair.

Order No.	Description	List Price
7-0457	Utility Hinge	\$11.29

**Perko Fig. 808 Hinge**



- Chrome plated zinc alloy.
- Open width 3". Pin height 1-1/2".
- Uses #8 fasteners.
- Sold per pair.

Order No.	Mfg. No. / Description	List Price
542325	(0808 DPO CHR)	\$29.49

**Marpac Utility Hinge**



- Stamped stainless steel.
- Open width 2".
- Pin length 1-1/2".
- Uses #8 fasteners.
- Sold per pair.

Order No.	Description	List Price
7-0458	Utility Hinge	\$10.59

**Perko Fig. 988 Offset Shortside Hinge**



- Chrome plated bronze.
- Open width 2-1/4".
- Pin height 1-1/2".
- Shortside width 3/4", offset 3/8".
- Uses #8 fasteners.
- Sold per pair.

Order No.	Mfg. No. / Description	List Price
544230	(0988 DP1 CHR)	\$71.39

**Perko Fig. 1213 Shortside Hinge**



- Chrome plated zinc alloy.
- Pin height 1-1/2".
- Open width 2-1/2".
- Shortside width 3/4". Uses #8 fasteners.
- Sold per pair.

Order No.	Mfg. No. / Description	List Price
533338	(1213 DP1 CHR)	\$23.49

**Perko Fig. 1214 Offset Shortside Hinge**



- Chrome plated zinc alloy.
- Open width 2-1/2".
- Pin height 1-1/2".
- Shortside width 3/4", offset 3/8".
- Uses #8 fasteners.
- Sold per pair.

Order No.	Mfg. No. / Description	List Price
533340	(1214 DP1 CHR)	\$23.49

**Perko Fig. 1293 Loose Pin Butt Hinges**



- Chrome plated zinc alloy.
- Stainless steel removable pin.
- Uses #8 fasteners, except 534176 uses #10 fasteners.
- Sold per pair.

Order No.	Mfg. No. / Description	List Price
534138	(1293 DP3 CHR) 1-1/2" x 2" 4 Screws Per Hinge	\$23.69
534188	(1293 DP4 CHR) 2" x 2" 4 Screws Per Hinge	\$24.19
534176	(1293 DP9 CHR) 3" x 3" 6 Screws Per Hinge	\$31.09

**Perko Fig. 951 Hinge**



- Chrome plated bronze.
- Open width 3". Pin height 1-1/2".
- Uses #8 fasteners.
- Sold per pair.

Order No.	Mfg. No. / Description	List Price
543858	(0951 DP1 CHR)	\$76.59

**Marpac Utility Hinge**



- Stainless steel.
- Flush mount.
- Dimensions: 2.664" x 1.5".
- Sold per pair.

Order No.	Description	List Price
7-1010	Utility Hinge	\$14.19

**Perko Fig. 942 Offset Hinge**



- Chrome plated zinc alloy.
- Open width 1-1/2".
- Pin height 1-1/2".
- Offset 3/8".
- Uses #8 fasteners.
- Sold per pair.

Order No.	Mfg. No. / Description	List Price
543746	(0942 DPO CHR)	\$22.99

**Marpac Offset Shortside Hinge**



- Polished, stamped type 304 stainless steel.
- Thickness .060" gauge.
- Open width 2", pin length 1-1/2", offset 3/8".
- Uses #8 fasteners.
- Sold per pair.

Order No.	Description	List Price
7-1005	Shortside Hinge	\$13.59



**Marpac Strap Hinges**



- Polished, cast 316 stainless steel.
- Uses #10 fasteners.
- Sold per pair.

Order No.	Description	List Price
7-0500	Dimensions: 4" x 1" 4 Screw Holes	\$17.89 GO-9911000
7-0501	Dimensions: 6" x 1" 6 Screw Holes	\$20.79 GO-3931000

**Marpac Flush Mount Concealed Hinge**



- Stamped type 304 stainless steel with satin finish.
- Dimensions: 2-3/4" x 1-7/8".
- Sold per pair.

Order No.	Description	List Price
7-0105	Flush Mount Concealed Hinge	\$8.09 GO-2450000

**Marpac Chrome Plated Brass Motor Box Hinge**



- Heavy duty chrome plated brass.
- Removable.
- Length 4", width at pin: 2-1/8".
- Uses #14 fasteners (not included).

Order No.	Description	List Price
7-0211	Motor Box Hinge	\$11.39 GO-3670000

**Perko Fig. 957 Non-Mortised Hinge**



- Chrome plated stamped brass.
- Easily installs without mortising.
- Closed width 7/8".
- Pin height 3-3/8".
- Uses #8 fasteners.
- Sold per pair.

Order No.	Mfg. No. / Description	List Price
543959	(0957 DPO CHR)	\$34.89 GO-8332000

**Piano Hinges**

- Sold in 18" lengths only.

**STAINLESS STEEL - .040 GAUGE**

Order No.	Mfg. No. / Description	List Price
2000934	(SS040125-18) Open Width 1-1/4"	\$10.89 HO-3560000
2000935	(SS040150-18) Open Width 1-1/2"	\$10.19 HO-1160000
2000936	(SS040200-18) Open Width 2"	\$12.39 HO-3470000

**Marpac Strap Hinges**



- Polished, stamped type 304 stainless steel.
- Uses #8 fasteners.
- Sold per pair.

Order No.	Description	List Price
7-0455	Dimensions: 4" x 1-3/16"	\$11.49 GO-0770000
7-0456	Dimensions: 6" x 1-3/16"	\$13.79 GO-4290000

**Perko Fig. 271 Inset Hinge**



- Chrome plated stamped brass.
- Semi-concealed for inset doors.
- Dimensions: 2-3/4" x 2-1/2". Inset 3/8".
- Uses #4 fasteners. Sold per pair.

Order No.	Mfg. No. / Description	List Price
536613	(0271 DPO CHR) Display Pack	\$28.39 GO-2091000
536601	(0271 000 CHR) Bulk	\$32.89 GO-4022000

**Marpac Hatch Hinge**



- Polished stainless steel.
- Length 2-7/8", width 2-5/8", height 1-5/32".
- Uses #10 fasteners.

Order No.	Description	List Price
7-0213	Hatch Hinge	\$31.69 GO-3212000

**Continuous "Piano" Hinges**



**ALUMINUM - MILL FINISH**

- 3/16" holes drilled on 4" centers.

Order No.	Description	List Price
740515	Open Width 1-1/2" Length 6' .040" Gauge	\$15.69 HO-1490000
740527	Open Width 2" Length 6' .040" Gauge	\$23.89 HO-3341000

**TYPE 304 STAINLESS STEEL BRIGHT ANNEALED - .040" GAUGE**

- Drilled and countersunk on 2" centers.

Order No.	Open Width	Length	Uses	List Price
740565	1-1/4"	6'	#5 Fasteners	\$37.69 HO-1622000
740577	1-1/2"	6'	#6 Fasteners	\$38.29 HO-7922000
740589	2"	6'	#6 Fasteners	\$50.09 HO-5003000



**SPECIAL HANDLING MAY APPLY**



- Electronics
- Trolling Motors
- Instruments
- Electrical
- Lighting
- Anchor & Dock
- Safety
- Steering, Controls
- Pumps
- Fuel System
- Seating & Pedestals
- Trailering
- Tops & Covers
- Perform.
- Propellers
- Engine & Care
- Cleaning & Care
- Paint & Paint Acc.
- Fun & Flotation
- Topside Acc.
- Cockpit & Deck
- Hardware, Fasteners
- Camouflage
- Misc.
- Comm.

## Lenco Electric Hatch Lifts

### 12-Volt Models



#### Lenco Electric Hatch Lifts / 12-Volt Models

Order No.	Lenco Part#	Superseded Part#	L.O.A. Retract	Approx. Stroke	L.O.A. Extend	Price
249789	20760-001	HL-400	15"	4"	19"	\$394.29 G0-7146200
249804	20764-001	HL-800S	20"	8"	28"	\$419.89 G0-3318200
252748	20768-001	HL-1200S	24"	12"	36"	\$446.49 G0-5199200
252749	20770-001	HL-1200	29"	12"	41"	\$448.79 G0-9600300
252750	20774-001	HL-1600S	29"	16"	45"	\$496.69 G0-8723300
252762	20776-001	HL-1600	33"	16"	49"	\$484.29 G0-7442300
252774	20778-001	HL-2000S	33"	20"	53"	\$540.69 G0-6226300
252786	20780-001	HL-2000	37"	20"	57"	\$526.29 G0-1625300
249878	20782-001	HL-2400S	37"	24"	61"	\$586.79 G0-5139300
249880	20784-001	HL-2400	41"	24"	65"	\$586.79 G0-5139300
249892	20788-001	HL-3000	47"	30"	77"	\$628.79 G0-9212400

12-Volt models with 2' leads and deutsch connectors. Includes high impact, corrosion proof mounting brackets and stainless steel pull pins.



- Electronics
- Trolling Motors
- Instruments
- Electrical
- Lighting
- Anchor & Dock
- Safety
- Steering, Controls
- Pumps
- Fuel System
- Seating & Pedestals
- Trailering
- Tops & Covers
- Perform.
- Propellers
- Engine & Care
- Cleaning & Care
- Paint & Paint Acc.
- Fun & Flotation
- Topside Acc.
- Cockpit & Deck
- Hardware, Fasteners
- Camouflage
- Misc.
- Comm.

#### Features include:

- ▶ Clear anodized aluminium tubing
- ▶ Clutchless ball screw design will not drift, never binds and runs in sync on dual lift applications
- ▶ Inline motor design delivers over **500 lbs** of force
- ▶ Water resistant & non-corrosive materials
- ▶ Ball screw spins freely when hatch is fully opened or closed eliminating limit switches and burned out motors
- ▶ Powdered metal gears for strength and precision
- ▶ Stainless steel ram locks in any position
- ▶ CE-certified, ignition protected and ABYC compliant
- ▶ 20 AMP circuit breaker & 20 AMP rated switch required



Please visit [lencomarine.com](http://lencomarine.com) for hatch lift mounting specifications.

#### HATCH LIFT EXTENSION HARNESSES & OTHER ACCESSORIES AVAILABLE BELOW

Order No.	Lenco Part#	Description	Price
252577	15096-001	Rocker Switch for Single hatch lift applications Clamshell packaged	\$64.29 G0-7034000
252580	15098-001	For Dual hatch lift applications Clamshell packaged	\$85.29 G0-4175000

#### Single Rocker Switch for Hatch Lifts

Single Rocker Switch for hatch lifts with two 30" non-terminated power leads. For single and dual hatch lift applications



## Deutsch Connected Actuator Extension Harnesses

### Replacement Part



Order No.	Lenco Part #	Description	Price
252655	30133-001D	7' 16-AWG Clamshell Packaged	\$28.59 G0-6191000
252659	30133-002D	14' 16-AWG Clamshell Packaged	\$35.29 G0-4632000
252661	30133-103D	20' 14-AWG Clamshell Packaged	\$41.79 G0-0082000
252936	30142-201	26' 12-AWG Poly Bagged	\$80.09 G0-6635000

#### Deutsch Connected Actuator Extension Harnesses

To be used with all Lenco Electric Hatch Lift Models ABYC Compliant  
(Sold individually - one needed per actuator)



## Stainless Steel Non-Locking Slide Bracket

### For use with Hatch Lifts



Order No.	Lenco Part #	Description	Price
249999	70381-001	Stainless Steel Slide Bracket	\$63.99 G0-7824000

In case of power failure, this bracket allows you to pull the hatch open a minimum of 5" in order to remove bolt for access.



**Marpac Gas Spring Hatch Lifts**



- Stainless steel.
- Socket End Style.
- The ideal solution for lifting, lowering and counterbalancing weight.
- The gas spring is a self-contained, nitrogen-driven counterbalance product which provides uniform handle forces, non-catastrophic failure and many years of service.
- Because energy is provided through gas pressure, our gas springs give you repeatable, unvarying performance which is superior to mechanical, spring or damper type products.

Order No.	Retracted Length	Approximate Stroke	Extended Length	Output Force	Shaft Dia.	List Price	
7-1386	5.5"	2"	7.5"	20 lbs.	6mm	\$22.49	G0-7051000
7-1375	7"	3"	10"	40 lbs.	8mm	\$29.99	G0-9002000
7-1387	7"	3"	10"	40 lbs.	6mm	\$23.99	G0-7061000
7-1388	7"	3"	10"	60 lbs.	6mm	\$26.39	G0-8671000
7-1389	8"	4"	12"	30 lbs.	6mm	\$29.89	G0-3002000
7-1377	9.5"	5.5"	15"	20 lbs.	8mm	\$32.29	G0-3612000
7-1390	9.5"	5.5"	15"	40 lbs.	6mm	\$30.39	G0-6302000
7-1379	9.5"	5.5"	15"	60 lbs.	8mm	\$35.49	G0-8732000
7-1392	10.2"	7"	17.2"	20 lbs.	6mm	\$28.79	G0-9291000
7-1381	10.2"	7"	17.2"	40 lbs.	8mm	\$37.39	G0-5052000
7-1394	12"	8"	20"	60 lbs.	6mm	\$31.29	G0-6902000
7-1383	12"	8"	20"	90 lbs.	8mm	\$37.39	G0-5052000
7-1385	12"	8"	20"	120 lbs.	8mm	\$37.39	G0-5052000

**BRACKETS FOR GAS SPRING HATCH LIFTS - SOLD IN PAIRS**

- Corrosion resistant stainless steel.
- Uses #10 fasteners.

Order No.	Description	List Price	
7-1396	Flat Mount with 10mm Ball Stud	\$8.99	G0-2060000
7-1397	90° Mount with 10mm Ball Stud	\$8.99	G0-2060000
7-1398	90° Mount with 10mm Ball Stud	\$11.09	G0-3470000

**Attwood Mounting Brackets for Gas Springs**



- Constructed of zinc plated steel with a black painted finish.
- Pem type: Ball 10mm. Pem direction: Forward.
- Sold each.

Order No.	Mfg. No. / Description	List Price	
2350214	(SL50BP3-1)	\$5.39	F0-7730000
2350216	(SL58BP3-1)	\$2.99	F0-9020000
2350217	(SL65BP3-1)	\$2.89	F0-2020000

**White Cap Lid-Lift Gas Springs**



- Heavy duty steel coated with heat cured paint.
- O-ring insures proper sealing to force oil towards the orifice piston.
- Piston assembly provides precise control during the extension stroke.
- Sold individually.

Order No.	Mfg. No.	Extended	Compressed	Supports	List Price	
2011540	(G-3120C)	7.5"	5.5"	20 lbs.	\$20.99	H0-9521000
2011541	(G-3140C)	7.5"	5.5"	40 lbs.	\$20.99	H0-9521000
2011536	(G-3020C)	10"	7"	20 lbs.	\$20.99	H0-9521000
2011538	(G-3040C)	10"	7"	40 lbs.	\$20.99	H0-9521000
2011555	(G-3520C)	12"	8.5"	20 lbs.	\$20.99	H0-9521000
2011556	(G-3530C)	12"	8.5"	30 lbs.	\$20.99	H0-9521000
2011542	(G-3320C)	15"	9.5"	20 lbs.	\$20.99	H0-9521000
2011543	(G-3330C)	15"	9.5"	30 lbs.	\$20.99	H0-9521000
2011544	(G-3340C)	15"	9.5"	40 lbs.	\$20.99	H0-9521000
2011546	(G-3360C)	15"	9.5"	60 lbs.	\$20.99	H0-9521000
2011558	(G-3620C)	17"	10.25"	20 lbs.	\$20.99	H0-9521000
2011559	(G-3630C)	17"	10.25"	30 lbs.	\$20.99	H0-9521000
2011560	(G-3640C)	17"	10.25"	40 lbs.	\$20.99	H0-9521000
2011562	(G-3660C)	17"	10.25"	60 lbs.	\$20.99	H0-9521000
2011563	(G-3690C)	17"	10.25"	90 lbs.	\$20.99	H0-9521000
2011548	(G-3420C)	20"	12"	20 lbs.	\$20.99	H0-9521000
2011549	(G-3430C)	20"	12"	30 lbs.	\$20.99	H0-9521000
2011550	(G-3440C)	20"	12"	40 lbs.	\$20.99	H0-9521000
2011551	(G-3460C)	20"	12"	60 lbs.	\$20.99	H0-9521000
2011553	(G-3480C)	20"	12"	80 lbs.	\$20.99	H0-9521000
2011554	(G-3490C)	20"	12"	90 lbs.	\$20.99	H0-9521000
2011547	(G-34120C)	20"	12"	120 lbs.	\$20.99	H0-9521000

**ZINC PLATED STEEL BRACKETS - SOLD EACH**

Order No.	Mfg. No. / Description	List Price	
2011531	(G-1015C) 1-3/4" L x 5/8" W x 1-1/4" H	\$7.59	H0-5540000
2011532	(G-1020C) 2-1/2" L x 3/4" W x 1-7/16" H	\$7.59	H0-5540000

**BLACK COMPOSITE END FITTINGS - SOLD IN PAIRS**

Order No.	Mfg. No. / Description	List Price	
2011533	(G-1030C) Spring Retainer	\$11.79	H0-7070000
2011535	(G-1130C) Snap-On Cap	\$9.49	H0-9650000

**Attwood Zinc Plated Threaded Stud for Gas Springs**



- Used as an alternative to mounting brackets, threaded studs can be mounted directly to hatches or other mounting surfaces that are made of metal or another material with the strength to withstand the forces of a gas-spring attachment point.
- With 10mm ball end.
- Length 9/16"

Order No.	Mfg. No. / Description	List Price	
2350218	(SL69BS-1)	\$5.59	F0-1930000

- Electronics
- Trolling Motors
- Instruments
- Electrical
- Lighting
- Anchor & Dock
- Safety
- Steering, Controls
- Pumps
- Fuel System
- Seating & Pedestals
- Trailering
- Tops & Covers
- Perform.
- Propellers
- Engine & Care
- Cleaning & Care
- Paint & Paint Acc.
- Fun & Flotation
- Topside Acc.
- Cockpit & Deck
- Hardware, Fasteners
- Camouflage
- Misc.
- Comm.



**Perko Fig. 762 Hatch Support Brace**



Note: Illustration is port side.

- Chrome plated brass.
- One end angled base, the other end flat base.
- Open length 14".
- Uses #8 fasteners.
- Sold per pair (Port and Starboard).

Order No.	Mfg. No. / Description	List Price	
542111	(0762 DP3 CHR)	\$155.39	GO-1140100

**T-H Marine Lid and Hatch Support Springs**



- Features a stainless steel spring that snaps straight to a support position when opened.
- The stainless steel spring then supports the lid, hatch or cover in the open position.
- When closing simply deflect the spring which allows spring to bend and rotate at the mounting positions.
- Molded black nylon ends for mounting.

Order No.	Mfg. No.	Diameter	Length	Supports Up to	List Price	
641060	(LS-2-DP)	7/16"	8-1/2"	10 lbs.	\$17.99	HO-9701000
642368	(HS-1-DP)	5/8"	12"	20 lbs.	\$30.49	HO-9281000

**Handi-Man Windshield Support Tubes**



- Designed to fit many bow rider style boats, with walk through windshield.
- Black anodized aluminum tube resists corrosion.

Order No.	Mfg. No. / Description	List Price	
7270021	(01617) Length 10"	\$13.49	HO-9080000
7270022	(01619) Length 11"	\$13.29	HO-7970000
7270024	(01623) Length 13"	\$13.49	HO-9080000
7270025	(01625) Length 14"	\$13.29	HO-7970000

**Perko Figs. 1290 and 1291 Windshield Adjusters**



Note: Illustration is port side.

- Chrome plated zinc alloy.
- Black polymer knob.
- Length overall: 12".
- Adjustment length: 9-1/2".
- Uses #8 fasteners.
- Sold per pair (Port and Starboard).

Order No.	Mfg. No. / Description	List Price	
534087	(1290 DPO CHR) Side Mount	\$88.69	GO-2495000
534102	(1291 DPO CHR) Offset Mount	\$88.69	GO-2495000

**Marpac Hatch Support Spring**



- Stainless steel hatch spring holds open hatches, doors, table leaves, etc.
- Holds up to 10 lbs.
- Length 8".

Order No.	Description	List Price	
7-54208	Hatch Support Spring	\$6.39	GO-8240000

**Perko Fig. 797 Hatch Adjuster**



- Chrome plated brass and zinc alloy.
- Black polymer knob.
- Arm length: 10".
- Adjustable length: 9-1/2".
- Slide length: 10-3/4".
- Uses #8 fasteners.

Order No.	Mfg. No. / Description	List Price	
542301	(0797 DPO CHR)	\$129.99	HO-9977000

**Taylor Made Windshield Support Bars**



- Used as original equipment on many fine walk-thru windshields.
- Made from anodized aluminum tubing with nylon fittings.
- The fittings allow for pivot in almost every direction for easy installation.
- Sold in single units.

Order No.	Mfg. No. / Description	List Price	
723535	(1632) Length 11"	\$22.79	F0-5951000
723537	(1634) Length 12"	\$22.79	F0-5951000
723536	(1636) Length 13"	\$22.79	F0-5951000

**Perko Fig. 1116 Windshield Adjuster**



- Chrome plated brass and zinc alloy.
- Black polymer knob.
- Rod OD: 3/8".
- Rod length: 12".
- Uses #8 fasteners.
- Sold each.

Order No.	Mfg. No. / Description	List Price
532108	(1116 DP3 CHR)	\$85.39 GO-1275000

**Perko Fig. 769 Hatch Fastener or Windshield Keeper**



- Chrome plated brass and zinc alloy.
- Black polymer handle.
- Base dimensions: 1-1/2" x 5/8".
- Uses #8 fasteners.

Order No.	Mfg. No. / Description	List Price
542123	(0769 DPO CHR)	\$60.29 GO-9304000

**Marpac Windshield Fastener**



- Black nylon.
- Windshield quick release fasteners make removing and installing windshield easy.

Order No.	Description	List Price
7-54211	Windshield Fastener	\$6.49 GO-5340000

**Perko Fig. 935 Sliding Window Stop**



- Chrome plated zinc alloy with polymer cover on stopping plate.
- Stopping plate length 1-1/2".
- Mounting plate dimensions: 1-7/8" x 3/4".
- Uses #8 fasteners.

Order No.	Mfg. No. / Description	List Price
543668	(0935 DPO CHR)	\$17.59 GO-9711000

**Perko Fig. 697 Hatch Fastener or Windshield Keeper**



- Chrome plated brass and zinc alloy.
- Keeper: 1-1/2" x 3/4".
- Bracket: 1-1/2" x 5/8".
- Bolt length: 1-1/2".
- Uses #8 fasteners.

Order No.	Mfg. No. / Description	List Price
541385	(0697 DPO CHR)	\$38.29 GO-5652000

**Perko Fig. 967 Hatch Fastener or Windshield Keeper**



- Chrome plated bronze.
- Keeper dimensions: 1-7/8" x 7/8".
- Bracket dimensions: 1-9/16" x 1".
- Bolt length: 1-1/2".
- Uses #8 fasteners.

Order No.	Mfg. No. / Description	List Price
546929	(0967 DPO CHR)	\$96.49 GO-5646000

**T-H Marine Windshield Fastener**



- Molded of UV stable polymer that will not corrode.
- The base mounts with two screws to the boat and the quick twist fastener passes thru the windshield.
- Includes: Windshield fasteners, wing nut head and base.

Order No.	Mfg. No. / Description	List Price
642374	(WSH-1PR-DP) Sold Per Pair	\$15.29 HO-7190000

Electronics

Trolling Motors

Instruments

Electrical

Lighting

Anchor & Dock

Safety

Steering, Controls

Pumps

Fuel System

Seating & Pedestals

Trailering

Tops & Covers

Perform.

Propellers

Engine & Care

Cleaning & Care

Paint & Paint Acc.

Fun & Flotation

Topside Acc.

Cockpit & Deck

Hardware, Fasteners

Camouflage

Misc.

Comm.

**Marpac Stainless Steel Hold Down Clamp**



- Stainless steel.
- Dimensions: 3" L x 1-1/2" W.

Order No.	Description	List Price	
7-0223	Hold Down Clamp	\$24.79	GO-1661000

**Marpac Stainless Steel Hold Down Clamp**



- Stainless steel.
- Heavy duty.
- Uses #10 fasteners (not included).
- Dimensions: 4" L x 1-7/8" W x 1" H.

Order No.	Description	List Price	
7-0225	Hold Down Clamp	\$20.29	GO-9531000

**Perko Fig. 1112 Hold Down Clamp**



- Chrome plated bronze.
- Flat mounting.
- Dimensions: 1-1/2" W x 3" L.
- Uses #8 fasteners.

Order No.	Mfg. No. / Description	List Price	
532057	(1112DPO CHR)	\$88.39	GO-2295000

**Buck Algonquin Transom Door Latch**



- 316 stainless steel.
- Polish finish.
- Handle length: 6-1/4".
- Overall height: 1-1/4".
- Plate size: 1-1/2" W x 3" L.

Order No.	Mfg. No. / Description	List Price	
260757	(70TDLS625)	\$49.79	GO-6333000

**Marpac T-Handle Latch**



- Flexible.
- Non-corrosive, non-conductive, UV resistant materials.
- Compensates for misalignment in 3 planes.
- Built-in drag keeps latch stationary when unlatched.
- Length 4.81".

Order No.	Description	List Price	
7-2255	T-Handle Latch	\$11.69	GO-3870000

**Marpac Stainless Steel Hold Down Clamp**



- Stainless steel.
- 90° angle mounting
- Dimensions: 2-1/2" L x 1-1/2" W.

Order No.	Description	List Price	
7-0224	Hold Down Clamp	\$24.79	GO-1661000

**Marpac Chrome Plated Brass Hold Down Clamp**



- Chrome plated brass.
- Heavy duty.
- Uses #10 fasteners (not included).
- Dimensions: 4" L x 1-3/4" W.

Order No.	Description	List Price	
7-0214	Hold Down Clamp	\$10.39	GO-6960000

**Attwood Padlock Eye Clamp**



- Chrome finish.
- Flush mount.
- Has no exposed mounting screws.
- Accommodates padlocks with 1/4" diameter or smaller shackle.
- Rugged, secure locking device with easy-to-use flip handle.
- Closed size: 4-1/4" x 1-1/2".
- Uses (4) #8 fasteners.

Order No.	Mfg. No. / Description	List Price	
7000016	(2012A3)	\$26.29	F0-0481000

**Marpac Soft Draw Latch**



- Made with corrosion resistant materials.
- Over-center latching.
- Cushions impact, absorbs vibration, tolerates misalignment.
- Concealed mounted stainless steel keeper.
- Patented design.
- Dimensions: 4" x 1-1/2".

Order No.	Description	List Price	
7-2250	Draw Latch	\$23.39	GO-7651000

- Electronics
- Trolling Motors
- Instruments
- Electrical
- Lighting
- Anchor & Dock
- Safety
- Steering, Controls
- Pumps
- Fuel System
- Seating & Pedestals
- Trailering
- Tops & Covers
- Perform.
- Propellers
- Engine & Care
- Cleaning & Care
- Paint & Paint Acc.
- Fun & Flotation
- Topside Acc.
- Cockpit & Deck
- Hardware, Fasteners
- Camouflage
- Misc.
- Comm.



Perko Fig. 380 Grab Rail Posts



- Chrome plated bronze.
- Hollow, for 1" OD tubing.
- Height overall 3-3/8".
- Base OD 2-1/2".
- Uses #8 fasteners.

Order No.	Mfg. No. / Description	List Price
537994	(0380 000 CHR) End Post	\$130.79 HO-7487000
538009	(0380 A00 CHR) Center Post	\$111.59 GO-7747000

Marpac Cast Stainless Steel Rail Fittings - 30° Round Base



- Heavy duty cast type 316 marine grade stainless steel.
- Includes set screw.
- Skin packed.

Order No.	Description	List Price
7-0178	7/8" OD Tubing 2-5/8" Uses #10 Fasteners	\$15.39 GO-1301000
7-0978	1" OD Tubing 2-7/8" Uses 1/4 Fasteners	\$14.39 GO-4690000

Marpac Cast Stainless Steel Rail Fittings - 90° Round Base



- Heavy duty cast type 316 marine grade stainless steel.
- Includes set screw.
- Skin packed.

Order No.	Description	List Price
7-0180	7/8" OD Tubing 2-5/8" Uses #10 Fasteners	\$15.09 GO-1101000
7-0980	1" OD Tubing 2-3/4" Uses 1/4 Fasteners	\$15.69 GO-1501000

Marpac Cast Stainless Steel Rail Fittings - 60° Rectangular Base



- Heavy duty cast type 316 marine grade stainless steel.
- Includes set screw.
- Skin packed.

Order No.	Description	List Price
7-0182	7/8" OD Tubing Uses #10 Fasteners	\$15.39 GO-1301000
7-0982	1" OD Tubing Uses 1/4 Fasteners	\$15.69 GO-1501000

Marpac Hand Rail Bases



- 316 stainless steel hand rail bases.
- Fittings for 7/8" OD tubing have 1-1/2" base.
- Fittings for 1" OD tubing have 1-3/4" base.
- Have no set screw.

Order No.	Description	List Price
7-0187	Forward 120° For 7/8" OD Tubing	\$10.39 GO-6960000
7-0188	Center 60° For 7/8" OD Tubing	\$9.29 GO-2260000
7-0189	Aft 60° For 7/8" OD Tubing	\$10.49 GO-3070000
7-0987	Forward 120° For 1" OD Tubing	\$12.89 GO-4680000
7-0988	Center 60° For 1" OD Tubing	\$11.89 GO-7970000
7-0989	Aft 60° For 1" OD Tubing	\$11.89 GO-7970000

Marpac Cast Stainless Steel Rail Fittings - 60° Round Base



- Heavy duty cast type 316 marine grade stainless steel.
- Includes set screw.
- Skin packed.

Order No.	Description	List Price
7-0179	7/8" OD Tubing 2-5/8" Uses #10 Fasteners	\$14.79 GO-1990000
7-0979	1" OD Tubing 2-3/16" Uses 1/4 Fasteners	\$14.39 GO-4690000

Marpac Cast Stainless Steel Rail Fittings - 30° Rectangular Base



- Heavy duty cast type 316 marine grade stainless steel.
- Includes set screw.
- Skin packed.

Order No.	Description	List Price
7-0181	7/8" OD Tubing 2-5/8" Uses #10 Fasteners	\$15.39 GO-1301000

Marpac Cast Stainless Steel Rail Fittings - 90° Rectangular Base



- Heavy duty cast type 316 marine grade stainless steel.
- Includes set screw.
- Skin packed.

Order No.	Description	List Price
7-0183	7/8" OD Tubing Uses #10 Fasteners	\$15.59 GO-5401000
7-0983	1" OD Tubing Uses 1/4 Fasteners	\$14.39 GO-4690000

- Electronics
- Trolling Motors
- Instruments
- Electrical
- Lighting
- Anchor & Dock
- Safety
- Steering, Controls
- Pumps
- Fuel System
- Seating & Pedestals
- Trailer
- Tops & Covers
- Perform.
- Propellers
- Engine & Care
- Cleaning & Care
- Paint & Paint Acc.
- Fun & Flotation
- Topside Acc.
- Cockpit & Deck
- Hardware, Fasteners
- Camouflage
- Misc.
- Comm.

**Marpac Cast Stainless Steel Rail Fittings - 60° Tee**



- Heavy duty cast type 316 marine grade stainless steel.

Order No.	Description	List Price
7-0202	7/8" OD Tubing	\$13.99 G0-7390000
7-1002	1" OD Tubing	\$13.99 G0-7390000

**Marpac Cast Stainless Steel Rail Fittings - 90° Tee**



- Heavy duty cast type 316 marine grade stainless steel.

Order No.	Description	List Price
7-0186	7/8" OD Tubing	\$11.69 G0-3870000
7-0986	1" OD Tubing	\$11.69 G0-3870000

**Marpac Cast Stainless Steel Rail Fittings - 90° Elbows**



- Heavy duty cast type 316 marine grade stainless steel.

Order No.	Description	List Price
7-0192	7/8" OD Tubing	\$12.99 G0-0780000
7-0992	1" OD Tubing	\$12.39 G0-0380000

**Marpac Cast Stainless Steel Rail Fitting - 110° Bow Form**



- Heavy duty cast type 316 marine grade stainless steel.

Order No.	Description	List Price
7-0190	7/8" OD Tubing	\$29.59 G0-3891000

**Taco Marine Tubing for Rail Fittings**



- With a closely drawn inside and outside diameter tolerance, our extruded round aluminum is an excellent product to use with rail and top fittings.
- When compared to standard extruded tube, our aluminum extruded tube maintains superior strength, stability and quality appearance.

**ALUMINUM TUBING**

- Brite anodized finish.

Order No.	Description	Wall Thickness	List Price
741909	7/8" x 6'	.058"	\$42.09 F0-6492000
741911	7/8" x 20'	.058"	\$70.69 F0-8494000

**STAINLESS STEEL TUBING**

- High polished, type 304.

Order No.	Description	Wall Thickness	List Price
741935	7/8" x 6'	.049"	\$48.89 F0-2243000
741947	7/8" x 20'	.065"	\$152.99 F0-9070100
741973	1" x 6'	.049"	\$49.09 F0-6343000
741985	1" x 20'	.065"	\$167.19 F0-3071100

Electronics

Trolling Motors

Instruments

Electrical

Lighting

Anchor & Dock

Safety

Steering, Controls

Pumps

Fuel System

Seating & Pedestals

Trailer

Tops & Covers

Perform.

Propellers

Engine & Care

Cleaning & Care

Paint & Paint Acc.

Fun & Flotation

Topside Acc.

Cockpit & Deck

Hardware, Fasteners

Camouflage

Misc.

Comm.

**SPECIAL HANDLING MAY APPLY**

T-H Marine Molded Boat Grab Handles



- Molded, UV resistant grab handles.
- Soft overmold on firm handle.
- Textured for sure grip.
- Rubberized ergonomic feel.
- Hidden fasteners.
- Center of screw to center of screw measures 7-1/4".

Order No.	Mfg. No. / Description	List Price
327318	(GHB-1-DP) Black	\$14.19 HO-1580000
327319	(GHB-1FW-DP) White	\$14.19 HO-1580000

Marpac Utility Transom Handle



- Heavy duty cast marine grade stainless steel.
- Use #10 fasteners.
- Dimensions: 5-7/8" L x 1-15/16" W x 1-13/16" H.

Order No.	Description	List Price
7-0648	Transom Handle	\$12.99 GO-0780000

Perko Fig. 775 Handles



- Chrome plated bronze.
- Sold per pair.

LENGTH OVERALL 4-1/4"

- Length inside 2-1/2". Height inside 7/8". Uses #6 fasteners.

Order No.	Mfg. No. / Description	List Price
547452	(0775 DP1 CHR)	\$72.99 GO-0984000

LENGTH OVERALL 5-3/4"

- Length inside 3-5/8". Height inside 1-3/8". Uses #8 fasteners.

Order No.	Mfg. No. / Description	List Price
542161	(0775 DP2 CHR)	\$85.49 GO-8275000

Perko Fig. 610 Wardrobe or Utility Hook



- Chrome plated zinc alloy.
- Base width 1-1/8". Projection 1-3/8".
- Uses #6 fasteners.

Order No.	Mfg. No. / Description	List Price
541195	(0610 DPO CHR)	\$6.09 GO-8040000

Perko Fig. 975 Coat and Hat Hook



- Chrome plated zinc alloy.
- Base width 1-1/4". Projection 3".
- Uses #6 fasteners.

Order No.	Mfg. No.	List Price
544141	(0975 DP2 CHR)	\$6.99 GO-8640000

Detmar Snap Cover Grab Handle



- Attractively styled, this hard grip handle has integrated, hinged caps which snap over the mount holes so no fasteners are visible after mounting.
- No loose caps make installation handling easier and eliminate cap loss.
- Textured to blend with any interior or exterior application.
- 2-hole for 1/4" machine or wood screws.
- Dimensions: 9" L x 2-3/16" H x 1-1/8" W with 1-1/2" finger clearance.

Order No.	Mfg. No. / Description	List Price
2000538	(12-1300) Black	\$5.29 FO-0730000

Perko Fig. 1222 Handle



- Chrome plated zinc alloy.
- Length overall 5-3/4".
- Inside dimensions: 3-5/8" L x 1-1/4" H. Uses #8 fasteners.
- Sold per pair.

Order No.	Mfg. No. / Description	List Price
533439	(1222 DPO CHR)	\$20.69 GO-6831000

Perko Fig. 1231 Handle



- Chrome plated zinc alloy.
- Length overall 6".
- Inside dimensions: 3-1/2" L x 1-5/16" H. Uses 1/4" fasteners.
- Sold per pair.

Order No.	Mfg. No. / Description	List Price
533617	(1231 DPO CHR)	\$24.69 GO-4561000

White Cap Hand Rail Stanchions



- 304 stainless steel.
- Length 12".

Order No.	Mfg. No. / Description	List Price
2011651	(S-7091P) Includes 1/4"-20 Studs	\$60.79 HO-7463000
2011653	(S-7094P) No Studs, Requires 1/4" Fastener	\$33.69 HO-1202000

Perko Fig. 344 Folding Step



- Chrome plated manganese bronze.
- Stainless steel spring holds step in open or closed position.
- Step dimensions: 4-1/8" x 2-1/4". Bracket dimensions: 4-1/4" x 1-3/4".
- Folded projection 1-3/8".
- Uses 5/16" R.H. fasteners.

Order No.	Mfg. No. / Description	List Price
537603	(0344 DPO CHR)	\$170.79 GO-3441100

- Electronics
- Trolling Motors
- Instruments
- Electrical
- Lighting
- Anchor & Dock
- Safety
- Steering, Controls
- Pumps
- Fuel System
- Seating & Pedestals
- Trailering
- Tops & Covers
- Perform.
- Propellers
- Engine & Care
- Cleaning & Care
- Paint & Paint Acc.
- Fun & Flotation
- Topside Acc.
- Cockpit & Deck
- Hardware, Fasteners
- Camouflage
- Misc.
- Comm.



**Marpac Stainless Steel Hollow Base Cleats**



- Polished stainless steel.
- Fastens with 1/4" screws.

Order No.	Description	List Price	
7-0169	Length 4-1/2"	\$10.89	GO-0370000
7-0170	Length 6"	\$16.79	GO-5211000
7-0171	Length 8"	\$26.19	GO-5571000
7-0172	Length 10"	\$44.19	GO-1692000

**Marpac Galvanized Standard Dock Cleats**

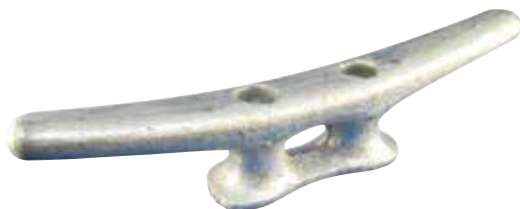

- Hot dipped galvanized gray iron.
- Measured from tip to tip.

Order No.	Description	List Price	
7-2290B	Length 4"	\$2.19	GO-7410000
7-2292B	Length 6"	\$2.69	GO-0810000
7-2294B	Length 8"	\$5.89	GO-5930000
7-2296B	Length 10"	\$9.39	GO-9260000
7-2298B	Length 12"	\$13.99	GO-7390000

**Perko Fig. 530 Aluminum Open Base Cleats**



- Heavy duty aluminum.

Order No.	Mfg. No. / Description	List Price	
540472	(0530 008 ALU) Length 8"	\$49.59	GO-3233000
540484	(0530 010 ALU) Length 10"	\$75.59	GO-5605000
540496	(0530 012 ALU) Length 12"	\$123.29	GO-0628000

**Buck Algonquin Stainless Steel Open Base Cleat**



- Polished 316 stainless steel.
- Predrilled with four holes.
- Base dimensions: 1-3/8" W x 4" L.
- Overall length 14-7/8", overall height 3-15/16".

Order No.	Mfg. No. / Description	List Price	
263378	(70COBS1500)	\$208.69	GO-2893100

**Perko Fig. 545 Aluminum Plain Finished Cleats**



- Pressure cast aluminum.

**CLOSED BASE - LENGTH 6"**

Order No.	Mfg. No. / Description	List Price	
540725	(0545 DP6 ALU)	\$16.79	GO-5211000

**OPEN BASE - LENGTH 8"**

Order No.	Mfg. No. / Description	List Price	
540737	(0545 DP8 ALU)	\$22.89	GO-4351000

**Marpac Zamak Open Base Cleats**



- Traditional style chrome plated zamak cleat.
- Open base.
- Uses #8 fasteners (Not included).

Order No.	Description	List Price	
7-54032	Length 4-1/2"	\$5.09	GO-1430000
7-54034	Length 6"	\$6.69	GO-8440000

**Perko Chromalex® Cleats**



- Chrome plated zinc alloy with black polymer base.
- Open base.

Order No.	Mfg. No. / Description	List Price
534277	(1306 DP1 CHR) Length 4-1/2" Sold Per Pair	\$25.89 G0-5371000
534289	(1306 DP2 CHR) Length 6" Sold Each	\$22.79 G0-7251000

**Marpac High Impact Nylon Cleats**



- Durable high impact black nylon yacht cleats.

Order No.	Length	Head Screws	Package	List Price
7-0340	4-1/2"	#10 Oval Machine	2 Per Card	\$2.79 G0-7810000
7-0340S	4-1/2"	#10 Oval Machine	Bucket of 24 Cleats	\$21.99 G0-3741000
7-0341	6"	1/4" Oval Machine	2 Per Card	\$3.59 G0-1420000
7-0341B	6"	1/4" Oval Machine	Bulk, Sold Each	\$2.79 G0-7810000
7-0341S	6"	1/4" Oval Machine	Bucket of 24 Cleats	\$27.99 G0-5781000
7-0338	8"	1/4" Oval Machine	2 Per Card	\$6.39 G0-8240000
7-0338B	8"	1/4" Oval Machine	Bulk, Sold Each	\$5.49 G0-8630000
7-0339	10"	5/16" Oval Machine	2 Per Card	\$7.29 G0-8840000
7-0339B	10"	5/16" Oval Machine	Bulk, Sold Each	\$7.09 G0-5740000

**Attwood Neat Cleat**



- Each stanchion is a 7/8" rod of solid enhanced #316 stainless steel alloy.
- The friction springs holds the cleat up at any position and make sure it stays up when pulled up.
- Has a neat, continuous contour to prevent snags and stubbed toes.
- The receptacle outlet is sized for standard 1/4" pilot tubing (not included) so you can use parts from existing inventory.

Order No.	Mfg. No. / Description	List Price
334005	(66517-7) Length 6"	\$81.09 F0-6765000

**Accon Slim-Line™ Pull-Up Cleats**

- Made of marine grade 316 stainless steel.
- Sleek, narrow design allows for installation where other flush-mounted cleats won't fit.
- Easy to pull up, the recess in the base allows the cleat to be grasped quickly and easily.
- Each cleat is shipped with a backing plate which also serves as the cut-out template.

Order No.	Mfg. No. / Description	Call for Price
S/O	(304-4) Length 4-1/2"	Call for Price
S/O	(304-6) Length 6"	Call for Price
S/O	(304-8) Length 8"	Call for Price
S/O	(304-10) Length 10"	Call for Price
S/O	(304-10) Waterproofing Cup for 304-4	Call for Price
S/O	(304-6C) Waterproofing Cup for 304-6	Call for Price
S/O	(304-8C) Waterproofing Cup for 304-8	Call for Price
S/O	(304-10C) Waterproofing Cup for 304-10	Call for Price

**Perko Fig. 1326 Open Base Cleat**



- Chrome plated zinc alloy with black polymer base.
- Base dimensions: 3-5/8" x 7/8".

Order No.	Mfg. No. / Description	List Price
5315076	(1326 DP2 CHR) Length 5-3/4"	\$19.09 G0-9721000

**Mossy Oak® Camouflage Nylon Cleats**



- Open base nylon cleat.
- Good for boats or docks.
- 2 mounting holes.
- Mossy Oak Shadow Grass Blades pattern.

Order No.	Mfg. No. / Description	List Price
1-34070	(34070) Length 4-1/2"	\$5.69 E0-7240000
1-34071	(34071) Length 6"	\$7.89 E0-2950000

**Marpac Deluxe Pull Up Cleats**



- Use only a drill or hole saw for installation.
- Closed position only 1/2" above deck.
- Water resistant O-ring included.
- Uses standard 3/8" studs.
- Wider finger grip for ease of use.
- Eliminates standing water on base.

Order No.	Description	List Price
7-1017	Length 4" Slim Line Design	\$72.59 G0-4684000
7-1018	Length 6" Wide Base Design	\$80.99 G0-6245000

**Accon Marine**



- Electronics
- Trolling Motors
- Instruments
- Electrical
- Lighting
- Anchor & Dock
- Safety
- Steering, Controls
- Pumps
- Fuel System
- Seating & Pedestals
- Trailering
- Tops & Covers
- Perform.
- Propellers
- Engine & Care
- Cleaning & Care
- Paint & Paint Acc.
- Fun & Flotation
- Topside Acc.
- Cockpit & Deck
- Hardware, Fasteners
- Camouflage
- Misc.
- Comm.

Accon Flush-Mounted Pull-Up Cleats

Accon Marine



- Made of marine grade 316 stainless steel.
- Sealed base eliminates the need for a waterproofing cup, water can be drained through a fitting at the bottom of the unit.
- Can be converted to a lifting cleat by inserting a connecting rod in the base of the unit and attaching the rod to the bow eye.
- Each cleat is shipped with a backing plate that also serves as the cut-out template.
- Screws are not included.

Order No.	Mfg. No. / Description	Call for Price
S/O (209-4)	Length 4-1/2"	Call for Price
S/O (209-4-CA)	Length 4-1/2" with Lifting Hardware	Call for Price
S/O (209-4-LH)	Lifting Hardware for 4-1/2"	Call for Price
S/O (209-6)	Length 6"	Call for Price
S/O (209-6-CA)	Length 6" with Lifting Hardware	Call for Price
S/O (209-6-LH)	Lifting Hardware for 6"	Call for Price
S/O (209-8)	Length 8"	Call for Price
S/O (209-8-CA)	Length 8" with Lifting Hardware	Call for Price
S/O (209-8-LH)	Lifting Hardware for 8"	Call for Price
S/O (209-10)	Length 10"	Call for Price
S/O (209-10-CA)	Length 10" with Lifting Hardware	Call for Price
S/O (209-10-LH)	Lifting Hardware for 10"	Call for Price
S/O (209-10-S)	Length 10", Stud Mount	Call for Price
S/O (209-10-S-CA)	Length 10" with Lifting Hardware, Stud Mount	Call for Price
S/O (209-4-TMP)	Top-Mount Backing Plate for 209-4	Call for Price
S/O (209-6-TMP)	Top-Mount Backing Plate for 209-6	Call for Price
S/O (209-8-TMP)	Top-Mount Backing Plate for 209-8	Call for Price
S/O (209-10-TMP)	Top-Mount Backing Plate for 209-10	Call for Price

Accon Pull-Up Cleats

Accon Marine



- Made of marine grade 316 stainless steel.
- Each cleat is supplied with a waterproofing cup.
- Each cleat is shipped with a backing plate that also serves as the cut-out template.
- Fasten with (4) screws (Not included).

Order No.	Mfg. No. / Description	Call for Price
S/O (205-12)	Length 12" Through-Bolted	Call for Price
S/O (205-12-S)	Length 12" Stud Mount	Call for Price
S/O (115-15)	Length 15" Through-Bolted	Call for Price
S/O (115-15-S)	Length 15" Stud Mount	Call for Price

Accon Pop-Up® Cleats

Accon Marine



- Made of marine grade 316 stainless steel.
- Cleat pops up at the touch of a button - simply push it back down when it is no longer needed and it locks in the flush position.
- In the up position, Pop-Up Cleats function exactly like conventional cleats.
- Each cleat is shipped with a backing plate which also serves as the cut-out template.
- Screws are not included.

Order No.	Mfg. No. / Description	Call for Price
S/O (202-4)	Length 4-1/2"	Call for Price
S/O (202-6)	Length 6"	Call for Price
S/O (202-6-S)	Length 6" Stud Mount	Call for Price
S/O (202-8)	Length 8"	Call for Price
S/O (202-8-S)	Length 8" Stud Mount	Call for Price
S/O (202-10)	Length 10"	Call for Price
S/O (202-4C)	Waterproofing Cup for 202-4	Call for Price
S/O (202-6C)	Waterproofing Cup for 202-6	Call for Price
S/O (202-8C)	Waterproofing Cup for 202-8	Call for Price
S/O (202-10C)	Waterproofing Cup for 202-10	Call for Price
S/O (202-4-TMP)	Top-Mount Backing Plate for 202-4	Call for Price
S/O (202-6-TMP)	Top-Mount Backing Plate for 202-6	Call for Price
S/O (202-8-TMP)	Top-Mount Backing Plate for 202-8	Call for Price
S/O (202-10-TMP)	Top-Mount Backing Plate for 202-10	Call for Price
S/O (600)	Brass Through Hull Fitting	Call for Price
S/O (601)	Plastic Through Hull Fitting	Call for Price
S/O (602)	Stainless Steel Through Hull Fitting	Call for Price

Accon Wide-Line Cleats

Accon Marine



- Sleek, low profile appearance.
- Large flange helps cover rough cut-out area.
- Made of marine grade 316 stainless steel.
- Mounts from the bottom via welded stainless steel threaded studs.
- Each cleat is shipped with a 1/8" thick backing plate which also serves as the cut-out template.
- Drill four holes and saw-cut clearance between the two center holes.

Order No.	Mfg. No. / Description	Call for Price
S/O (305-4)	Length 4-1/2"	Call for Price
S/O (305-6)	Length 6"	Call for Price
S/O (305-8)	Length 8"	Call for Price
S/O (305-10)	Length 10"	Call for Price

WATERPROOFING CUP

Order No.	Mfg. No. / Description	Call for Price
S/O (305-4C)	For 305-4	Call for Price
S/O (305-6C)	For 305-6	Call for Price
S/O (305-8C)	For 305-8	Call for Price
S/O (305-10C)	For 305-10	Call for Price



**Accon Lifting Cleat**

*Accon Marine*

Lift Cleat with Base (203-6-CB)



Complete Lift Cleat Assembly (203-6-CA)



- All stainless steel parts.
- Cleat and base are 316, lifting hardware is 304.
- Standard rod length is 12".
- The sling is a solid casting for increased strength.
- A cut-out template is supplied.
- Fastens to deck with four #10 screws (not included).
- The maximum working load is 4,000 lbs. in the direction of the axis of the threaded rod shank only.

Order No.	Mfg. No. / Description	Call for Price
S/O	(203-6-CA) Complete Lift Cleat Assembly	Call for Price

**ACCESSORIES**

Order No.	Mfg. No. / Description	Call for Price
S/O	(203-6-CB) Lift Cleat with Base	Call for Price
S/O	(209-6-R) Rod, 12"	Call for Price
S/O	(209-6-R-18) Rod, 18"	Call for Price
S/O	(209-6-R-24) Rod, 24"	Call for Price
S/O	(203-SPE) Sling (Casting)	Call for Price
S/O	(203-CBL) Cross Bar for Sling	Call for Price
S/O	(203-BE) Bow Eye	Call for Price

**Accon Oval Lifting Eye**

*Accon Marine*

- Small compact unit.
- Unit can be drained or sealed water tight.
- Hub pivots two ways to overcome a slight misalignment at installation.
- All stainless steel parts; eye and base are 316, lifting hardware is 304.
- The sling is a solid casting for increased strength.
- Requires less clearance under deck than our lifting cleats.
- Fastens to deck with four #10 screws (Not included).



Order No.	Mfg. No. / Description	Call for Price
S/O	(201-EA) Complete Lift Eye Assembly	Call for Price
S/O	(201-LE) Lift Eye with Base	Call for Price
S/O	(201-LER) 12" Rod	Call for Price
S/O	(203-S) Sling (Casting)	Call for Price
S/O	(203-CBL) Cross Bar for Sling	Call for Price
S/O	(203-BE) Bow Eye	Call for Price

**Accon Extra Large Round Lifting Eye**

*Accon Marine*

- All stainless steel parts; eye and base are 316, lifting hardware is 304.
- The sling is a solid casting for increased strength.
- 3-1/4" diameter hole required.
- Fastens to deck with four 1/4" screws (Not included).



Order No.	Mfg. No. / Description	Call for Price
S/O	(203-EA-XL) Complete Lift Eye Assembly	Call for Price
S/O	(203-XL) Lift Eye with Base	Call for Price
S/O	(203-BE) Bow Eye	Call for Price

**Accon Folding Cleats**

*Accon Marine*



Model 333-4



Model 332-6

- Mounts on the surface of the boat.
- No cut-outs or hole saws required.
- These cleats lock down when not needed, and spring up when release button is pushed in.
- Model 333 Cleat - Release slide is located on the top of the cleat.
- Model 332 Cleat - Release button is located on the side of the cleat.
- No drain receptacles required. They do not leak into the boat.
- Constructed of marine grade 316 cleat SS and brightly polished.

Order No.	Mfg. No. / Description	Call for Price
S/O	(333-3.5) Length 3-1/2" Visible Screw Holes	Call for Price
S/O	(334-3.5) Length 3-1/2" No Visible Screw Holes	Call for Price
S/O	(333-4) Length 4-1/2" Visible Screw Holes	Call for Price
S/O	(334-4) Length 4-1/2" No Visible Screw Holes	Call for Price
S/O	(332-6) Length 6" Visible Screw Holes	Call for Price
S/O	(332-6-S) Length 6" No Visible Screw Holes	Call for Price
S/O	(332-8) Length 8" Visible Screw Holes	Call for Price
S/O	(332-8-S) Length 8" No Visible Screw Holes	Call for Price

**Accon Round Lifting Eye**

*Accon Marine*

- All stainless steel parts; eye and base are 316, lifting hardware is 304.
- The sling is a solid casting for increased strength.
- 2-3/8" diameter hole required.
- Fastens to deck with four #10 screws (Not included).
- Standard rod length is 12".
- Parts may be purchased separately.
- The maximum working load is 4,000 lbs. in the direction of the axis of the threaded rod shank only. Test results available upon request.



Order No.	Mfg. No. / Description	Call for Price
S/O	(203-EA) Complete Lift Eye Assembly	Call for Price
S/O	(203-LE) Lift Eye with Base	Call for Price
S/O	(203-LER) 12" Rod	Call for Price
S/O	(203-S) Sling (Casting)	Call for Price
S/O	(203-CBR) Cross Bar for Sling	Call for Price
S/O	(203-BE) Bow Eye	Call for Price

**Accon Lifting Eye Accessories**

*Accon Marine*

Pivot Attachment



Order No.	Mfg. No. / Description	Call for Price
S/O	(201-DP) Drain Plug	Call for Price
S/O	(201-DF) Drain Fitting	Call for Price
S/O	(209-PA) Pivot Attachment	Call for Price

- Electronics
- Trolling Motors
- Instruments
- Electrical
- Lighting
- Anchor & Dock
- Safety
- Steering, Controls
- Pumps
- Fuel System
- Seating & Pedestals
- Trailering
- Tops & Covers
- Perform.
- Propellers
- Engine & Care
- Cleaning & Care
- Paint & Paint Acc.
- Fun & Flotation
- Topside Acc.
- Cockpit & Deck
- Hardware, Fasteners
- Camouflage
- Misc.
- Comm.

**Marpac Lifting Eye with Cleat**



- Polished, type 316 cast stainless steel.
- Threaded for 5/8" - 11 rod.
- Sold each.

Order No.	Description	List Price
7-0176	Lifting Eye	\$32.79 GO-7912000

**Marpac Lifting Eye**



- Polished 316 stainless steel.
- Tapped for 5/8" connecting rods.
- Large 1-1/2" inside diameter eye.
- Lifting eye with O-ring.

Order No.	Description	List Price
7-0177	Lifting Eye	\$39.59 GO-3562000

**Marpac Adjustable Keel Plate**



- Cast stainless steel.
- Shank dimensions: 3/8" x 3".
- Uses 5/8" threaded rod.

Order No.	Description	List Price
7-0125	Keel Plate	\$52.79 GO-7353000

**Marpac Stainless Steel Rope Deck Pipe**



- Cast stainless steel.
- Base dimensions: 5-5/8" x 4-1/16".

Order No.	Description	List Price
7-0941	Rope Deck Pipe	\$102.39 GO-0686000

**Stainless Steel All Threaded Rods**

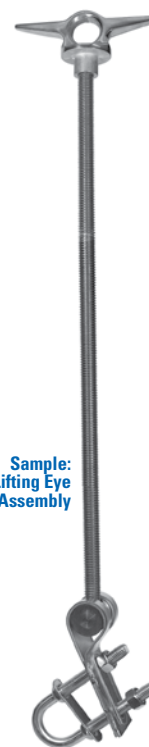

Sample: Lifting Eye Assembly

- Length 3'.

Order No.	Description	List Price
731479	10-24	\$9.49 HO-9650000
731481	1/4-20	\$10.69 HO-1460000
731483	5/16-18	\$16.09 HO-5690000
731485	3/8-16	\$22.59 HO-5531000
731487	1/2-13	\$44.19 HO-1562000
731489	5/8-11	\$46.09 HO-5672000
731491	3/4-10	\$114.39 HO-3686000

**Perko Fig. 757 Rope Deck Pipe**



- Chrome plated zinc alloy.
- Maximum rope size: 1".
- Flange OD 3-3/8".
- Uses #8 fasteners.

Order No.	Mfg. No. / Description	List Price
542009	(0757 DPO CHR)	\$34.69 GO-4232000

**Perko Fig. 1057 Rope Deck Pipe**



- High impact black polymer.
- UV stabilized, fiber reinforced.
- Hinged, snap-down cover.
- Maximum rope size: 7/8".
- Flange OD 3-3/4".
- Uses #8 fasteners.

Order No.	Mfg. No. / Description	List Price
531585	(1057 DPO BLK)	\$20.39 GO-6631000

**Perko Fig. 752 Oval Hawse Hole Plate**



- Chrome plated bronze.
- Eliminate deck and rope chaffing when cleats are mounted on a vertical surface inside cockpits.
- Spigot length 1-1/4".
- Outside dimensions: 4-1/4" x 6", inside dimensions: 2-1/8" x 4-1/8".
- Uses 1/4" fasteners.

Order No.	Mfg. No. / Description	List Price
541967	(0752 000 CHR)	\$149.79 GO-6300100

**Marpac Bow Chock**



- Polished, type 316 cast stainless steel.
- Length 4-1/2".
- Sold per pair.

Order No.	Description	List Price
7-0173	Bow Chock	\$30.69 G0-6502000

**Marpac Straight Chock**



- Stainless steel.
- Length 5".
- Sold per pair.

Order No.	Description	List Price
7-0940	Straight Chock	\$31.69 G0-3212000

**Perko Fig. 1223 Skene Bow Chock**



- Chrome plated zinc alloy.
- Maximum rope size: 1/2".
- Overall length 3-1/2". Width 7/8".
- Uses #8 fasteners.

Order No.	Mfg. No. / Description	List Price
533453	(1223 DPO CHR)	\$12.99 G0-0780000

**Accon Folding Chocks**



- Folds down when not in use.
- Marine grade 316 stainless steel.
- Surface mount - no cut-out required.

Order No.	Mfg. No. / Description	Call for Price
S/O	(502-4) Length 4-1/2"	Call for Price
S/O	(502-6) Length 6"	Call for Price

**Accon Pop-Up® Chocks**



- Chock easily pulls up for use.
- Simply press it down when not needed to keep deck clutter free.
- Made of marine grade 316 stainless steel.
- Fastens to deck with two #10 screws (not included).

Order No.	Mfg. No. / Description	Call for Price
S/O	(500) 4-1/2" Set of Port & Starboard Chocks	Call for Price
S/O	(500-6) 6" Set of Port & Starboard Chocks	Call for Price
S/O	(501) 4-1/2" Straight Stern Chock	Call for Price
S/O	(501-6) 6" Straight Stern Chock	Call for Price
S/O	(500-DF) Drain Fitting	Call for Price
S/O	(500-DP) Drain Plug	Call for Price

- Electronics
- Trolling Motors
- Instruments
- Electrical
- Lighting
- Anchor & Dock
- Safety
- Steering, Controls
- Pumps
- Fuel System
- Seating & Pedestals
- Trailering
- Tops & Covers
- Perform.
- Propellers
- Engine & Care
- Cleaning & Care
- Paint & Paint Acc.
- Fun & Flotation
- Topside Acc.
- Cockpit & Deck
- Hardware, Fasteners
- Camouflage
- Misc.
- Comm.



**Marpac Stainless Steel Stern Eyes**



- All stainless steel.
- Large backing plate helps distribute loads.
- Mounting nuts included.

Order No.	Diameter	Shaft Length	List Price
7-0124	3/8"	3"	\$6.89 GO-2640000
7-0123	1/2"	3-7/16"	\$10.99 GO-6370000

**Marpac Stainless Steel Bow Eyes**



- All stainless steel.
- Rounded plates won't gouge fiberglass.
- Mounting nuts included.

Order No.	Diameter	Shaft Length	List Price
7-0122	3/8"	3"	\$6.49 GO-5340000
7-0120	1/2"	3-7/16"	\$10.49 GO-3070000

**EPCO Bow Eye**



- 304 stainless steel for marine applications.
- Easy to install - all 4 nuts adjustable to conform to surfaces, and later on, to compressed walls, if needed.
- Overall length: 8".
- Center to center: 2".
- Thread length: 5-1/2". Thread diameter: 5/8".
- Face plates and nuts included.

Order No.	Mfg. No. / Description	List Price
209232	(16-151-00000)	\$30.39 F0-7212000

**Marpac Twin Shank Bow Eye**



- Zamak chrome plated.
- For use on the bow or stern.
- Diameter: 3/8".
- Shaft length: 4-7/8".
- Washers and nuts included.

Order No.	Description	List Price
7-54135	Twin Shank Bow Eye	\$10.39 GO-6960000

**Marpac Bow/Stern Eye**



- Zamak chrome plated eye.
- Cadmium plated shanks, nut and washer.
- Eye hole: 1-1/2" ID.
- Diameter: 3/8".
- Shank length: 3" and 5" included.

Order No.	Description	List Price
7-54134	Bow/Stern Eye	\$7.29 GO-8840000

- Electronics
- Trolling Motors
- Instruments
- Electrical
- Lighting
- Anchor & Dock
- Safety
- Steering, Controls
- Pumps
- Fuel System
- Seating & Pedestals
- Trailer
- Tops & Covers
- Perform.
- Propellers
- Engine & Care
- Cleaning & Care
- Paint & Paint Acc.
- Fun & Flotation
- Topside Acc.
- Cockpit & Deck
- Hardware, Fasteners
- Camouflage
- Misc.
- Comm.