

# Catálogo de accesorios Náuticos



Perform.



Propellers



Engine  
& Care



Cleaning  
& Care



Paint &  
Paint Acc.



Fun &  
Flotation



Topside  
Acc.



Cockpit  
& Deck



Hardware,  
Fasteners



Camouflage



Misc.



Comm.



Parte 2

# 2021

El Navegante

[www.repuestoselnavegante.com](http://www.repuestoselnavegante.com)



- Trolling Motors
- Instruments
- Electrical
- Lighting
- Anchor & Dock
- Safety
- Steering, Controls
- Pumps
- Fuel System
- Seating & Pedestals
- Trailer
- Tops & Covers
- Perform.
- Propellers
- Engine & Care
- Cleaning & Care
- Paint & Paint Acc.
- Fun & Flotation
- Topside Acc.
- Cockpit & Deck
- Hardware, Fasteners
- Camouflage
- Misc.
- Comm.

## Bienvenidos a Repuestos El Navegante.

Aquí podrás encontrar mas de **35.000** productos de diferentes fabricantes, con una gran variedad de accesorios y componentes para tu embarcación, contamos con mas de 20 años de experiencia en el sector náutico, no dudes en contactarnos para aclarar cualquier duda que tengas, prestamos asesoría técnica lo que es un valor agregado, y te dará tranquilidad a la hora de tomar una decisión de compra.

### Nota Importante:

Debido a las restricciones causadas por el Covid 19, y otros problemas a nivel Mundial muchas empresas se vieron afectadas debido a la falta de materia prima, por este motivo tanto los precios como las fechas de entrega sufrieron cambios en gran cantidad de productos, comuníquese con nosotros a través del correo: [repuestoselnavegante@gmail.com](mailto:repuestoselnavegante@gmail.com) y solicite su presupuesto sin compromiso, también puede comunicarse vía Telegram o WhatsApp escaneando los códigos QR.

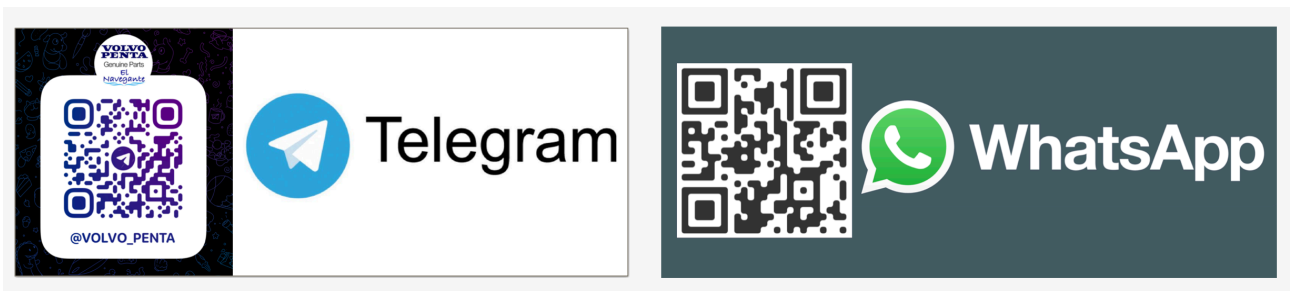

Los productos aquí publicados se encuentran en varias partes del mundo, pero la mayoría se encuentran en Estados Unidos y Europa, por lo que estos precios no incluyen gastos de envío.

También puede consultar en nuestra pagina [www.repuestoselnavegante.com](http://www.repuestoselnavegante.com) nuestros términos y condiciones antes de efectuar la compra, ahí podrá ver también nuestra política de devoluciones.

Los productos pueden ser entregados en un currier de su confianza.

En nuestra pagina podrá encontrar mas de **3.500** productos para entrega inmediata.

Nos especializamos en repuestos Volvo Penta, Cummings, Yanmar, Caterpillar, Mercruiser.

Ofrecemos repuestos para Generadores Onan, Kohler, Westerbeke, Fisher Panda y Northern Lights.



## Bottom Paint Comparison Chart

Types of Paint	Marpro	Pettit	Interlux	Sea Hawk
<b>Ablative</b> - Also known as self-polishing bottom paint, it is softer than hard-bottom paint and allows the coating to wear off at a controlled rate. Much like a bar of soap, once the boat moves in the water or there is a current and/or tide, the outer layer slowly wears away and reduces the paint buildup. The wearing away of the self-polishing bottom paint allows for new, unoxidized paint to be exposed. Therefore, if you are trailering your boat, or if it comes in and out of the water for any reason, it is recommended to use an ablative paint. Recommended for trailered boats.				
<b>BEST</b>	<b>Super-B Gold</b> Biocide: 67% Copper Dual Biocide: Yes	<b>Odyssey Triton</b> Triple Biocide	<b>Micron 66</b> (Saltwater Only) Biocide: 40.41% Copper Dual Biocide: Yes	<b>Biocop TF</b> Biocide: 38% Copper Dual Biocide: Yes
<b>BETTER</b>	<b>Super-B Ocean</b> Biocide: 45% Copper Dual Biocide: No	<b>Ultima SR-60</b> Biocide: 60% Copper Dual Biocide: Yes	<b>Micron Extra</b> Biocide: 38.6% Copper Dual Biocide: Yes	<b>Cukote</b> Biocide: 47.57% Copper Dual Biocide: No
<b>GOOD</b>	<b>Super-B Atlantic</b> Biocide: 35% Copper Dual Biocide: No	<b>Ultima SR-40</b> Biocide: 40% Copper Dual Biocide: Yes	<b>Micron CSC</b> Biocide: 37.2% Copper Dual Biocide: No	<b>AF33</b> Biocide: 47.57% Copper Dual Biocide: No
	<b>Super-B New England</b> Biocide: 25% Copper Dual Biocide: No	<b>Odyssey HD</b> Biocide: 45.7% Copper Dual Biocide: No		
		<b>Premium HRT</b> Biocide: 45.7% Copper Dual Biocide: No		
<b>Hard</b> - A hard modified epoxy. After a hard-bottom paint is applied, it is very durable and does not wear off. Hard bottom paints typically have a higher ratio of pesticides (usually copper) in them that are exposed in the outer surface of the bottom paint coating. As time goes by, the copper oxidizes and becomes less effective in combating marine growth. Hard bottom paint is generally used on boats when the boat sits for long periods of time without moving at all, or there is little movement of water (current/tide) around the boat. You should not use a hard paint if the boat is removed from the water longer than 72 hours, such as on a trailer or a lift. After 72 hours the hard-bottom paint will oxidize on the outer surface as a result of the air and becomes ineffective. If the boat is trailered or in a lift, the use of an ablative bottom paint is recommended.				
<b>BEST</b>	<b>Superkote Gold</b> Biocide: 67% Copper Dual Biocide: Yes	<b>Trinidad PRO/Trinidad SR</b> Biocide: 75% Copper Dual Biocide: Yes	<b>Ultra with Biolux</b> Biocide: 66% Copper Dual Biocide: Yes	<b>Tropikote</b> Biocide: 75.8% Copper Dual Biocide: Yes
<b>BETTER</b>	<b>Superkote Ocean</b> Biocide: 45% Copper Dual Biocide: No	<b>Trinidad HD</b> Biocide: 53.3% Copper Dual Biocide: No	<b>Fiberglass Bottomkote NT</b> Biocide: 25% Copper Dual Biocide: No	<b>Sharkskin</b> Biocide: 45.2% Copper Dual Biocide: Yes
<b>GOOD</b>	<b>Superkote Atlantic</b> Biocide: 35% Copper Dual Biocide: No	<b>Unepoxy HRT</b> Biocide: 23.7% Copper Dual Biocide: Yes		<b>Talon</b> Biocide: 33.6% Copper Dual Biocide: No
<b>Aluminum</b> Aluminum boat bottom paint that is copper-free, self-polishing, and safe for aluminum boats. The ideal bottom paint for pontoon boats and other aluminum boats.				
<b>BEST</b>	<b>Aluma Pro</b> Biocide: 45% Cuprous Thiocyanate Dual Biocide: No	<b>Vivid</b> Biocide: 25% Cuprous Thiocyanate Dual Biocide: Yes	<b>Trilux 33</b> Biocide: Cuprous Thiocyanate, Zinc Pyrithione Dual Biocide: Yes	<b>Mission Bay CF</b> Biocide: Zinc Oxide, Zinc Pyrithione Dual Biocide: No
<b>BETTER</b>	<b>Super-B ECO</b> Biocide: Zinc Omadine Dual Biocide: No	<b>ECO HRT</b> Biocide: Econeal, Zinc Pyrithione Dual Biocide: Yes	<b>Pacifica Plus</b> Biocide: Zinc Pyrithione Dual Biocide: Yes	<b>Smart Solution</b> Biocide: Econeal Dual Biocide: Yes
<b>GOOD</b>				<b>Color Kote</b> Biocide: Econeal, Zinc Omadine, Copper Thiocyanate Dual Biocide: Yes
<b>Water-Based</b> - Water-based bottom paints have low VOCs, are easy to apply, and clean up with water. They are also environmentally friendly. Water-based antifouling paints have little odor when applying and are perfect for indoor applications.				
<b>BEST</b>	<b>Aqua-B</b> Biocide: 45% Copper Dual Biocide: No	<b>Hydrocoat SR</b> Biocide: 40% Copper Dual Biocide: Yes	<b>Aqua One</b> Biocide: 28.45% Copper Dual Biocide: No	<b>Montery</b> Biocide: 54.67% Copper Dual Biocide: No
<b>BETTER</b>		<b>Hydrocoat ECO</b> Biocide: Econeal Dual Biocide: Yes	<b>Fiberglass Bottomkote Aqua</b> Biocide: 35% Copper Dual Biocide: No	
<b>GOOD</b>		<b>Hydrocoat</b> Biocide: 40% Copper Dual Biocide: No		
		<b>Neptune HRT</b> Biocide: 25.25% Copper Dual Biocide: No		

Electronics

Trolling Motors

Instruments

Electrical

Lighting

Anchor &amp; Dock

Safety

Steering, Controls

Pumps

Fuel System

Seating &amp; Pedestals

Trailering

Tops &amp; Covers

Perform.

Propellers

Engine &amp; Care

Cleaning &amp; Care

Paint &amp; Paint Acc.

Fun &amp; Flotation

Topside Acc.

Cockpit &amp; Deck

Hardware, Fasteners

Camouflage

Misc.

Comm.

**Bottom Paint Comparison Chart**

Types of Paint	Marpro	Pettit	Interlux
<b>Yacht Paint</b>			
			<b>Micron 99</b> (Boats Over 84') Biocide: Zinc Pyrithione  Dual Biocide: Yes
<b>Sailboat Paint</b>			
		<b>Black Widow</b> Biocide: 25% Copper Dual Biocide: Yes	<b>VC 17m Extra</b> Biocide: Cyclopropyl Dual Biocide: Yes
<b>Epoxy Primers</b>			
	<b>Mar-Protect Epoxy Primer</b> High build epoxy primer. Heavy duty 3:1 epoxy coating. Excellent anti-corrosive.	<b>Protect High Build Primer</b> Two component, epoxy coating. High-solids formula. Dependable corrosion protection. Reduces water absorption.	<b>InterProtect® 2000E/2001E</b> Two-part epoxy coating. Excellent adhesion. Long overcoating times. Use above & below waterline.
		<b>Alumaprotect Primer</b> 2 part strontium chromate. Primary coat over bare aluminum. Provides maximum resistance. Resists water.	<b>InterProtect® HS</b> High solids, two-part epoxy. Reduces water migration. Most restrictive VOC regulations.
<b>Primers</b>			
		<b>Rustlok Steel Primer</b> Moisture and corrosion proof. Water impervious barrier. Corrosion protection.	<b>Primocon® Underwater Primer</b> Anti-corrosive primer. Reduce pitting of the metal. For underwater metal surfaces.
		<b>Metal Primer</b> Two component primer. Self-etching type wash primer. Excellent adhesive bond. For use on bare metals.	<b>Primocon® Aerosol</b> Non-bleeding, anti-corrosive. Reduces galvanic corrosion.
		<b>Underwater Metal Kit</b> Includes metal primer and tie coat primer.	
<b>Prop, Underwater Hardware and Outdrive</b>			
		<b>Prop Coat Barnacle Barrier</b> Aerosol protection for bare metal including: Steel, stainless steel, cast iron, copper, bronze, galvanized steel and lead. Can be used above & below waterline.	<b>Trilux 33 Aerosol</b> Biolux technology. For aluminum outboards, Outdrives and aluminum hulls. For use in fresh, salt and brackish water.

- Electronics 
- Trolling Motors 
- Instruments 
- Electrical 
- Lighting 
- Anchor & Dock 
- Safety 
- Steering, Controls 
- Pumps 
- Fuel System 
- Seating & Pedestals 
- Trailerling 
- Tops & Covers 
- Perform. 
- Propellers 
- Engine & Care 
- Cleaning & Care 
- Paint & Paint Acc. 
- Fun & Flotation 
- Topside Acc. 
- Cockpit & Deck 
- Hardware, Fasteners 
- Camouflage 
- Misc. 
- Comm. 



# Safeguard Your Bottom Preserve Your Wallet<sup>SM</sup>



Antifouling Paints • Primers • Topside Enamels

[www.repuestoselnavegante.com](http://www.repuestoselnavegante.com) El Navegante



# HIGH LOAD COPPER BOTTOM PAINT



400 SQ FT / GAL YIELDS 2 MILS D.F.T.  
 TIME TO OVERCOAT - 80° F - 8 HRS  
 TIME TO LAUNCH - 16 HOURS  
 2 COATS, 3RD ON WATERLINE

THINNER  
 AS REQUIRED FOR  
 PROPER FLOW AND  
 PERFORMANCE  
 QUARTS - 7-2675  
 GALLONS - 7-2674



## Slime Control Xtra™ Multi-Season Protection - 67% Copper Boosted Copper Ablative

■ SUPER-B GOLD™ is the highest performance ablative copolymer on the market today. The highest copper content (67%) in our line, and in addition our performance booster SCX™ (Slime Control Xtra™) provides outstanding protection against slime, grass and weed. Continual release of biocide makes this self polishing copolymer most effective for anti-fouling protection, with only minimal paint buildup. Tough, multi-season paint for superior protection against hard and soft growth in extreme fouling conditions, and can re-launch after extended haul-out while retaining original antifouling properties. Perfect for powerboats and sailboats, and can be applied directly over properly prepared ablatives, epoxies and vinyl's, and most any other hard or ablative bottom paints.

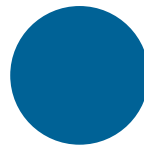

7-2629 Gallon  
 7-2630 Quart  
 BLUE

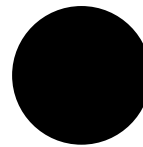

7-2633 Gallon  
 7-2634 Quart  
 BLACK



7-2627 Gallon  
 GREEN



7-2631 Gallon  
 RED



400 SQ FT / GAL YIELDS 2 MILS D.F.T.  
 TIME TO OVERCOAT - 80° F - 8 HRS  
 TIME TO LAUNCH - 16 HOURS  
 2 COATS, 3RD ON WATERLINE

THINNER  
 AS REQUIRED FOR  
 PROPER FLOW AND  
 PERFORMANCE  
 QUARTS - 7-2675  
 GALLONS - 7-2674



## Slime Control Xtra™ Multi-Season Protection - 67% Copper Boosted Hard Modified Epoxy

■ SUPERKOTE GOLD™ is the highest performance modified hard epoxy product on the market today. The highest copper content (67%) in our line, and in addition our performance booster SCX™ (Slime Control Xtra™) provides outstanding protection against slime, grass and weed. Continual release of biocide makes this modified hard epoxy the most effective for anti-fouling protection. Superior protection against hard and soft growth in extreme fouling conditions. Perfect for powerboats and sailboats, and can be applied directly over properly prepared epoxies and vinyls, and most any other hard bottom paints.

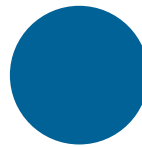

7-2609 Gallon  
 BLUE

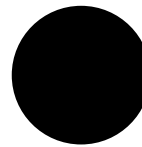

7-2613 Gallon  
 BLACK

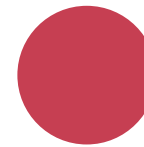

7-2611 Gallon  
 RED

# MEDIUM LOAD COPPER BOTTOM PAINT



400 SQ FT / GAL YIELDS 2 MILS D.F.T.  
 TIME TO OVERCOAT - 80° F - 8 HRS  
 TIME TO LAUNCH - 16 HOURS  
 2 COATS, 3RD ON WATERLINE

**THINNER**  
 AS REQUIRED FOR  
 PROPER FLOW AND  
 PERFORMANCE  
 QUARTS - 7-2675  
 GALLONS - 7-2674



## SUPER-B OCEAN™ Multi-Season Protection 45% Copper Ablative

■ **SUPER-B OCEAN™** has a high cuprous oxide content (45%) with a coating that provides a self-polishing ablative technology. This coating will provide multi-season protection for moderate fouling conditions. No paint buildup will occur and eliminates the need for heavy sanding. Perfect for powerboats and sailboats in seasonal boating conditions. Can be applied directly over properly prepared vinyl's, epoxies and most any other hard or multi-season bottom paints.

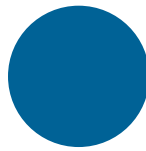

7-2635 Gallon  
 7-2636 Quart  
 BLUE

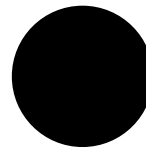

7-2639 Gallon  
 7-2640 Quart  
 BLACK

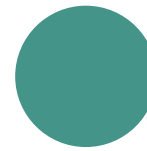

7-2641 Gallon  
 7-2642 Quart  
 GREEN



7-2637 Gallon  
 7-2638 Quart  
 RED



400 SQ FT / GAL YIELDS 2 MILS D.F.T.  
 TIME TO OVERCOAT - 80° F - 8 HRS  
 TIME TO LAUNCH - 16 HOURS  
 2 COATS, 3RD ON WATERLINE

**THINNER**  
 AS REQUIRED FOR  
 PROPER FLOW AND  
 PERFORMANCE  
 QUARTS - 7-2675  
 GALLONS - 7-2674



## SUPERKOTE OCEAN™ Multi-Season Protection - 45% Copper Hard Modified Epoxy

■ **SUPERKOTE OCEAN™** has a high cuprous oxide content (45%) with a coating that provides a modified epoxy technology. This coating will provide multi-season protection for moderate fouling conditions. Perfect for powerboats and sailboats in seasonal boating conditions. Can be applied directly over properly prepared vinyl's, epoxies and most any other hard bottom paints.

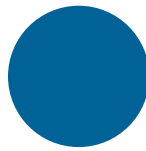

7-2619 Gallon  
 7-2620 Quart  
 BLUE

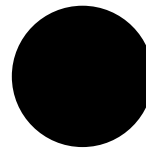

7-2623 Gallon  
 7-2624 Quart  
 BLACK

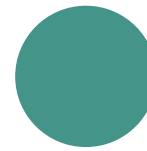

7-2617 Gallon  
 7-2618 Quart  
 GREEN



7-2621 Gallon  
 7-2622 Quart  
 RED

# SINGLE SEASON COPPER BOTTOM PAINT



## Single Season Ablative - 35% Copper

■ **SUPER-B ATLANTIC™** is a single-season, high cuprous oxide ablative antifouling bottom paint that utilizes a highly effective self-polishing technology. No paint buildup will occur and eliminates the need for heavy sanding when it's time to re-coat your hull. SUPER-B ATLANTIC is perfect for powerboats and sailboats in seasonal boating condition. Apply directly over properly prepared vinyls, epoxies and most other hard or multi-season bottom paints.

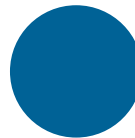

7-2821 Gallon  
BLUE

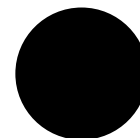

7-2818 Gallon  
BLACK



## Single Season Ablative - 25% Copper

■ **SUPER-B NEW ENGLAND™** is a single-season, good performing ablative antifouling bottom paint that protects against hard and soft growth in low-to-moderate fouling conditions. This product is self-polishing with no heavy paint buildup from repainting seasonally. Apply directly over any properly sanded hard or ablative bottom paint or epoxy primer.

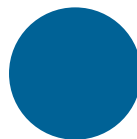

7-2872 Gallon  
BLUE

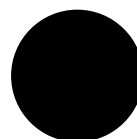

7-2874 Gallon  
BLACK



7-2878 Gallon  
BLUE



7-2876 Gallon  
RED



# ALUMINUM BOAT BOTTOM PAINT



**THINNER**  
AS REQUIRED FOR  
PROPER FLOW AND  
PERFORMANCE  
QUARTS - 7-2675  
GALLONS - 7-2674



## ALUMA PRO™

Multi-Season Protection

Bright Color Ablative Bottom Paint

Perfect For Aluminum, Fiberglass Hulls, & Trailerable Boats

45% Copper Thiocyanate

■ **ALUMA PRO™** bottom paint has the cleanest, brightest colors, the whitest whites and the blackest black. Combine all of that with a multi-season self polishing ablative copolymer, and our bottom paint line is as effective as it is clean & vibrant. This product provides antifouling protection against barnacles, algae and hydroids in salt and fresh water on boat bottoms only. This product has universal application over all types of properly prepared bottom paints. For use on fiberglass, aluminum, wood & steel hulls.

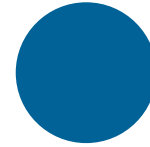

7-2603 Gallon  
7-2604 Quart  
BLUE

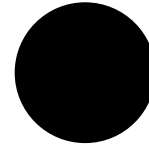

7-2605 Gallon  
7-2606 Quart  
BLACK

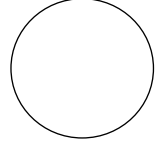

7-2600 Gallon  
7-2601 Quart  
WHITE

## WATER BASED BOTTOM PAINT



400 SQ FT / GAL YIELDS 2 MILS D.F.T.  
TIME TO OVERCOAT - 80° F - 8 HRS  
TIME TO LAUNCH - 16 HOURS  
2 COATS, 3RD ON WATERLINE

## AQUA B™

Multi-Season Protection

45% Copper Ablative

Water Based - No Solvent Smell

Cleans Up With Water

■ **AQUA B™** has a high copper content (45%) in a waterbase ablative technology. This coating will provide multi-season protection for medium fouling conditions. No paint buildup will occur and eliminates the need for heavy sanding. Multi-season paint for superior protection against hard and soft growth in fouling waters, and can re-launch after extended haul-out while retaining original antifouling properties. Perfect for powerboats and sailboats, and can be applied directly over properly prepared ablatives, epoxies and vinyl's, and most any other hard or ablative bottom paints.

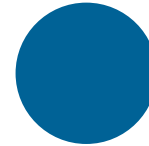

7-2708 Gallon  
7-2709 Quart  
BLUE

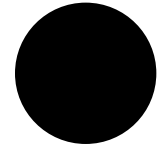

7-2710 Gallon  
7-2711 Quart  
BLACK

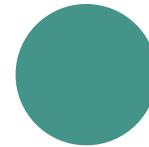

7-2712 Gallon  
7-2713 Quart  
GREEN

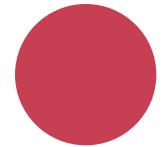

7-2714 Gallon  
7-2715 Quart  
RED

## COPPER FREE BOTTOM PAINT



## SUPER-B ECO™

Multi-Season Protection

Copper Free Antifouling

Professional Boatyard Coating

5.6% Tralopyril & 4% Zinc Pyrithione

■ **SUPER-B ECO™** is a high performance solvent-base antifouling paint that uses a high-end technology of 5.6% tralopyril and 4% zinc pyrithione. Provides multi season antifouling protection against barnacles, algae, slime and hydroids in salt and fresh water on boat bottoms only. Its ablative copolymer base renders a smooth finish with durability and abrasion resistance. Releases biocide by the constant exposure of new paint film to the water. Has universal application over all types of properly prepared bottom paints. For use on fiberglass boats, as well as aluminum, wood and steel hulls.

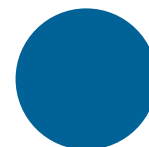

7-2811 Gallon  
BLUE

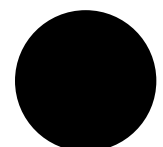

7-2802 Gallon  
7-2800 Quart  
7-2798 Pint  
BLACK

# EPOXY PRIMER



## Barrier Coat Primer - 7-267-

■ **MAR-PROTECT™ EPOXY PRIMER** provides a seamless epoxy coating that creates a high build water barrier that eliminates any direct path for water migration. Mar-Protect Epoxy Primer is a heavy duty 3:1 epoxy coating that prevents water absorption and blistering of your fiberglass hull, and makes an ideal barrier coat for metal hulls.

- High Build Epoxy Primer
- Prevents Water Absorption and Blistering
- Eliminates Direct Path for Water Migration
- Heavy Duty 3:1 Epoxy Coating
- Excellent Anti-Corrosive Substrate Primer for Metals

# TOPSIDE ENAMEL



## Alkyd Topside Enamel

■ **PROFESSIONAL FISHBOAT COATINGS** are single component topside alkyd enamels giving you a hard protective coating for high gloss, color retention, and long durability. PROFESSIONAL FISHBOAT COATINGS are fast drying which, when brushed or rolled, give a smooth finish with excellent handle and flow. This widely used alkyd topside enamel has good resistance to tough chemicals, cleaning solutions and ultraviolet light with its advanced ultraviolet technology. Can be used on fiberglass, wood, aluminum and steel.

- Brushed or rolled gives a smooth finish with excellent handle and flow
- High Gloss with Great UV protection
- Good color retention
- Good durability to cleaning solutions, abrasion & stains
- Fiberglass, Wood, Aluminum and Steel
- High Performance Coating for Marine, Industrial & Offshore Structures

▶ **THINNER**  
AS REQUIRED FOR  
PROPER FLOW AND  
PERFORMANCE  
QUARTS - 7-2675  
GALLONS - 7-2674

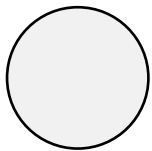

7-2696 Gallon  
7-2697 Quart  
**WHITE UNDERCOAT  
(Primer)**

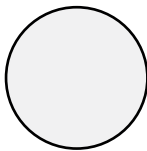

7-2662 Gallon  
7-2663 Quart  
**SEMI-GLOSS  
WHITE**

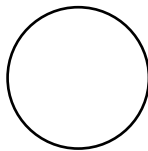

7-2649 Gallon  
7-2650 Quart  
**GLOSS WHITE**

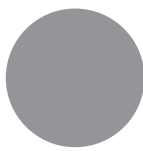

7-2652 Gallon  
7-2653 Quart  
**MEDIUM GRAY**

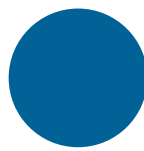

7-2658 Gallon  
7-2659 Quart  
**BLUE**

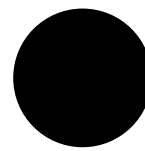

7-2654 Gallon  
7-2657 Quart  
**BLACK**

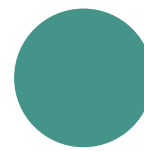

7-2656 Gallon  
7-2657 Quart  
**GREEN**

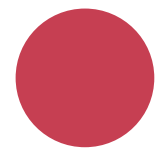

7-2664 Gallon  
7-2665 Quart  
**RED**

# PAINT COMPARISON CHART

MARPRO®	INTERLUX®	PETTIT®	SEAHAWK®	WEST MARINE®	SEACHOICE
SUPER-B GOLD™	Micron 66™	Ultima SR™	Tropikote Biocide™	—	—
SUPERKOTE GOLD™	Ultra™	Trinidad SR™	Tropikote™	—	—
SUPER-B OCEAN™	Micron CSC™	Horizons™ or Odyssey™	Cukote™	CPP Plus™	Yacht Shield™
SUPERKOTE OCEAN™	F/B Bottomkote™	Unepoxy Plus™	Sharkskin™	BottomShield™	Ultimate Defense™
ALUMA PRO™	Trilux 33™	Vivid™	Mission Bay™	—	—
SUPER-B ATLANTIC™	Act™	HRT Premium™	AF 33™	—	Ablative Plus™
SUPER-B ECO™	Pacific Plus™	HRT Eco™ or Ultima ECO™	Smart Solution™	—	—
SUPER-B NEW ENGLAND™	—	Neptune HRT™	Talon™	Bottomshield™	Ablative Plus™
AQUA-B™	Aqua-One™	Hydrocoat™	Monterey™	WBA™	—
MAR-PROTECT™ EPOXY PRIMER	Inter Protect	Pettit Protect	Tuff Stuff	—	—
FISHBOAT COATING TOPSIDE ENAMEL	Brightside	EZPoxy	—	—	—

Interlux® and Interlux® products are registered trademarks of the Akzo Nobel Company. Pettit® & Pettit® products are registered trademarks of RPM®. Seahawk® and Seahawk® products are registered trademarks of New Nautical Coatings. West Marine® products are registered trademarks of West Marine®.

# APPLICATION TIPS

## APPLYING ANTIFOULING PAINTS

- Mechanically stir the paint thoroughly
- Use a 3/8" - 1/2" nap solvent resistant roller. Recommended thickness is normally achieved by the application of 2 - 3 coats.
- Apply an extra coat of antifouling to the waterline. Allow paint to dry thoroughly between coats and prior to launch.
- Small amounts of thinner may be required but should be kept to a minimum.
- Only apply between 50 - 85 degrees F.
- Humidity greater than 65% may slow drying
- Do not paint in direct sunlight or high winds
- Surface must be dry and free from contamination
- All products are formulated to cover 400 square feet per gallon
- Read the product label thoroughly

## HOW MUCH ANTIFOULING PAINT DO I NEED?

The amount of paint needed can be summarized:

- $\text{Length} \times \text{Beam} \times .85 = \text{Total}$
- $\text{Total} / 400 \text{ square feet per gallon} = \text{Total Quantity Needed}$
- This is for 2 coats
- 2-3 coats are recommended

BOAT SIZE	BOTTOM PAINT NEEDED
14' Outboard	1 Quart
18' Runabout	2 Quarts
20' Sailboat	3 Quarts
24' Runabout	3 Quarts
30' Sailboat	1 Gallon plus 2 Quarts
32' Cruiser	1 Gallon plus 2 Quarts
36' Auxiliary	2 Gallons
40' Cruiser	2 Gallons

## ALUMINUM PONTOON BOTTOM SYSTEM

■ **MarPro's Aluma Pro** antifouling paint for aluminum and pontoon hulls, when applied over Mar-Protect Epoxy Primer, provides maximum protection for the hull preventing exposure to electrolysis and corrosion. By keeping the aluminum hull from coming in contact with both salt water and the antifouling paint film, this system eliminates the worries associated with protecting underwater aluminum.

### For Bare Hulls:

Many pontoon boat manufacturers apply a wax coating to pontoons before they leave the factory in order to better preserve the aluminum finish. This wax **MUST** be removed prior to painting.

1. Degrease/Dewax aluminum hull by scrubbing with a commercial dewaxer using a wet/dry method to remove this wax.
2. Sandblast or sand the surface with 60-grit sandpaper to achieve a good adhesion profile.
3. Apply two coats of Mar-Protect Epoxy Primer.
4. Apply two coats of Aluma Pro.

### For Previously Painted Hulls:

1. If the previous coating is compatible and is in good condition, thoroughly sand with 80-grit paper.
2. Solvent clean with MarPro Thinner to remove residue.
3. Apply one coat of Aluma Pro. If the previous coating is soft or in poor condition, remove to the bare surface by sanding or using a paint remover. Proceed with the Bare Hulls system as described above.

### For Previously Primed Hulls:

Mar-Protect Epoxy Primer may be applied over existing two-part epoxy finishes, provided they are in good condition. If existing primer is in poor condition, remove completely and proceed with the Bare Hulls system described above.

1. Sandblast, or heavily sand the surface with 60-grit sandpaper to achieve a good adhesion profile.
2. Wipe clean with MarPro Thinner.
3. Apply two coats of Mar-Protect Epoxy Primer.
4. Apply two coats of Aluma Pro. The coating performance is only as good as the surface to which it is applied.



[www.DonovanMarine.com](http://www.DonovanMarine.com)



**MARPRO ABLATIVE ANTIFOULING PAINTS**

**Marpro Super-B Gold™**



- High load copper boosted ablative.
- Self polishing ablative with cuprous oxide and SCX boosting biocides.
- Multi season protection.
- Relaunch without painting.
- Eliminates heavy sanding.
- Excellent protection for high to extreme fouling conditions.

Order No.	Color	Size	List Price	
7-2627	Green	Gallon	\$278.59	F0-1059100
7-2629	Blue	Gallon	\$278.59	F0-1059100
7-2630	Blue	Quart	\$92.09	F0-6446000
7-2631	Red	Gallon	\$278.59	F0-1059100
7-2633	Black	Gallon	\$278.59	F0-1059100
7-2634	Black	Quart	\$78.19	F0-3745000

**Marpro Super-B Ocean™**



- Medium load copper ablative.
- Self polishing protection.
- No paint build up.
- Eliminates heavy sanding.
- Good protection for moderate fouling conditions.

Order No.	Color	Size	List Price	
7-2641	Green	Gallon	\$151.39	F0-7950100
7-2642	Green	Quart	\$54.39	F0-7083000
7-2635	Blue	Gallon	\$151.39	F0-7950100
7-2636	Blue	Quart	\$54.39	F0-7083000
7-2637	Red	Gallon	\$151.39	F0-7950100
7-2638	Red	Quart	\$54.39	F0-7083000
7-2639	Black	Gallon	\$151.39	F0-7950100
7-2640	Black	Quart	\$54.39	F0-7083000

**Marpro Super-B Atlantic™**



- Single season copper ablative.
- Self polishing protection.
- No paint build up.
- Eliminates heavy sanding.
- Good protection for moderate fouling conditions.

Order No.	Color	Size	List Price	
7-2821	Blue	Gallon	\$108.09	F0-6657000
7-2818	Black	Gallon	\$108.09	F0-6657000

**Marpro Super-B New England™**



- Single season copper ablative.
- Controlled polishing ablative.
- Full season protection.
- No paint buildup. Eliminates heavy sanding.
- Excellent protection for low to moderate fouling conditions.

Order No.	Color	Size	List Price	
7-2878	Green	Gallon	\$94.49	F0-4166000
7-2872	Blue	Gallon	\$94.49	F0-4166000
7-2876	Red	Gallon	\$94.49	F0-4166000
7-2874	Black	Gallon	\$94.49	F0-4166000

**MARPRO ALUMINUM ANTIFOULING PAINTS**

**Marpro Aluma Pro™**



- Multi season self polishing ablative.
- Self polishing ablative with bright colors.
- Perfect for aluminum, fiberglass, wood and steel boats - including trailer boats.
- No paint buildup.
- Eliminates heavy sanding.
- Good protection for tough fouling conditions.

Order No.	Color	Size	List Price	
7-2600	White	Gallon	\$282.29	F0-0679100
7-2601	White	Quart	\$71.39	F0-7994000
7-2603	Blue	Gallon	\$295.59	F0-1960200
7-2604	Blue	Quart	\$76.29	F0-0435000
7-2605	Black	Gallon	\$295.59	F0-1960200
7-2606	Black	Quart	\$76.29	F0-0435000

**Marpro Super-B ECO™**



- Copper free antifouling.
- No copper with all hull types including aluminum.
- Contains combination of patented SCX biocides.
- Multi seasonal antifouling.
- Eliminates heavy sanding, compatible with other existing bottom systems.
- Good protection for moderate to high fouling conditions.

Order No.	Color	Size	List Price	
7-2811	Blue	Gallon	\$271.09	F0-6798100
7-2798	Black	Pint	\$43.29	F0-0303000
7-2800	Black	Quart	\$66.69	F0-8664000
7-2802	Black	Gallon	\$271.09	F0-6798100



**SPECIAL HANDLING MAY APPLY**



- Electronics
- Trolling Motors
- Instruments
- Electrical
- Lighting
- Anchor & Dock
- Safety
- Steering, Controls
- Pumps
- Fuel System
- Seating & Pedestals
- Trailering
- Tops & Covers
- Perform.
- Propellers
- Engine & Care
- Cleaning & Care
- Paint & Paint Acc.
- Fun & Flotation
- Topside Acc.
- Cockpit & Deck
- Hardware, Fasteners
- Camouflage
- Misc.
- Comm.

MARPRO HARD ANTIFOULING PAINTS

Marpro Superkote Gold™



- High load copper boosted hard modified epoxy.
- Multi season protection.
- Relaunch without painting.
- Eliminates heavy sanding.
- Excellent protection for high to extreme fouling conditions.

Order No.	Color	Size	List Price	
7-2609	Blue	Gallon	\$305.39	F0-7731200
7-2611	Red	Gallon	\$305.39	F0-7731200
7-2613	Black	Gallon	\$305.39	F0-7731200

Marpro Superkote Atlantic™



- SUPERKOTE ATLANTIC has a high cuprous oxide content (35%) with a coating that provides a modified epoxy technology.
- This coating will provide full season protection for moderate fouling conditions.
- Perfect for powerboats and sailboats in seasonal boating conditions.
- Can be applied directly over properly prepared vinyl's, epoxies and most any other hard bottom paints.

Order No.	Color	Size	List Price	
7-2592	Blue	Gallon	\$101.89	F0-2317000

Marpro Mar-Protect Epoxy Primer™



- Barrier coat primer.
- Prevents water absorption and blistering.
- Eliminates direct path for water migration.
- Heavy duty 3:1 epoxy coating.
- Excellent anti-corrosive substrate for metals.

Order No.	Size	List Price	
7-2670	Gallon	\$112.39	F0-7687000

Marpro Superkote Ocean™



- Medium load copper hard modified epoxy.
- Multi seasonal protection.
- No paint build up.
- Eliminates heavy sanding.
- Good protection for moderate fouling conditions.

Order No.	Color	Size	List Price	
7-2617	Green	Gallon	\$151.09	F0-6750100
7-2618	Green	Quart	\$52.29	F0-0663000
7-2619	Blue	Gallon	\$151.09	F0-6750100
7-2620	Blue	Quart	\$52.29	F0-0663000
7-2621	Red	Gallon	\$151.09	F0-6750100
7-2622	Red	Quart	\$52.29	F0-0663000
7-2623	Black	Gallon	\$151.09	F0-6750100
7-2624	Black	Quart	\$52.29	F0-0663000

MARPRO WATER-BASED ANTIFOULING PAINT

Marpro Aqua-B™



- High performance water based copper ablative.
- Self polishing water based ablative.
- Multi seasonal protection.
- No paint build up.
- Eliminates heavy sanding.
- Good protection for moderate fouling conditions.

Order No.	Color	Size	List Price	
7-2712	Green	Gallon	\$143.79	F0-5600100
7-2713	Green	Quart	\$51.69	F0-8163000
7-2708	Blue	Gallon	\$143.79	F0-5600100
7-2709	Blue	Quart	\$51.69	F0-8163000
7-2714	Red	Gallon	\$143.79	F0-5600100
7-2715	Red	Quart	\$51.69	F0-8163000
7-2710	Black	Gallon	\$143.79	F0-5600100
7-2711	Black	Quart	\$51.69	F0-8163000

Marpro Mar-Protect 70 High Solids Epoxy Primer™



- A surface tolerant, two part 70% solids tar free epoxy anticorrosive primer.
- Epoxy anticorrosive coating for use on the entire vessel: Underwater, topside, deck, house, water ballast tank, cofferdam, voids, cargo holds and internal spaces.

Order No.	Color	Size	List Price	
7-2680	White	Gallon	\$58.98	F0-9214000
7-2682	Medium Gray	Gallon	\$58.98	F0-9214000

SPECIAL HANDLING MAY APPLY

- Electronics
- Trolling Motors
- Instruments
- Electrical
- Lighting
- Anchor & Dock
- Safety
- Steering, Controls
- Pumps
- Fuel System
- Seating & Pedestals
- Trailer
- Tops & Covers
- Perform.
- Propellers
- Engine & Care
- Cleaning & Care
- Paint & Paint Acc.
- Fun & Flotation
- Topside Acc.
- Cockpit & Deck
- Hardware, Fasteners
- Camouflage
- Misc.
- Comm.

**Marpro Fishboat Coatings™ - Alkyd Topside Enamel**



- Alkyd topside enamel.
- Brushed or rolled gives a smooth finish with excellent handle and flow.
- High gloss with great UV protection.
- Good color retention.
- Good durability to cleaning solutions, abrasion and stains.
- Fiberglass, wood, aluminum and steel.
- High performance coating for marine, industrial and offshore structures.

Order No.	Color	Size	List Price	
7-2649	Gloss White	Gallon	\$53.69	F0-8573000
7-2650	Gloss White	Quart	\$15.39	F0-7701000
7-2652	Medium Gray	Gallon	\$53.69	F0-8573000
7-2653	Medium Gray	Quart	\$15.39	F0-7701000
7-2654	Gloss Black	Gallon	\$53.69	F0-8573000
7-2655	Gloss Black	Quart	\$15.39	F0-7701000
7-2656	Green	Gallon	\$53.69	F0-8573000
7-2657	Green	Quart	\$15.39	F0-7701000
7-2658	Blue	Gallon	\$53.69	F0-8573000
7-2659	Blue	Quart	\$13.39	F0-7390000
7-2662	Semi-Gloss White	Gallon	\$53.69	F0-8573000
7-2663	Semi-Gloss White	Quart	\$15.39	F0-7701000
7-2664	Red	Gallon	\$53.69	F0-8573000
7-2665	Red	Quart	\$15.39	F0-7701000

**Marpro Thinner for Marine Coatings**



- Improves application and flow of coating.
- Improves flow for brushing and rolling.
- Compatible with antifoulings, primers and enamels.
- Cleanup of paint supplies.

Order No.	Size	List Price	
7-2674	Gallon	\$31.89	F0-2322000
7-2675	Quart	\$11.79	F0-5280000

**Blue Water Coal Tar Epoxy Primer™**



- Heavy duty high build epoxy primer.
- 4:1 Mix ratio.
- Prevents rust and corrosion.
- Excellent adhesion and abrasion resistance.
- Provides 16 mils protection in two coats.
- Recommended for saltwater immersion service.
- Meets Coast Guard C-200 Specifications.

Order No.	Mfg. No.	Color	Size	List Price	
759069	(MA8003K)	Black	Gallon Kit	\$79.98	F0-9955000

**Marpro Camouflage Paint**



- Dull-finish marine paint is perfect for hunting or fishing vehicles.
- High quality, temporary finish for use on duck boats, skiffs and canoes.
- Easily removed with the included neutralizer.
- Brush, roll or spray on finish.

Order No.	Color	Size	List Price	
7-2661	Brown	Quart	\$15.39	F0-7701000

**Marpro White Undercoater**



- One coat is good for coverage of 75 square feet/quart.
- Great coverage, quick dry, great adhesion for topcoat.

Order No.	Size	List Price	
7-2697	Quart	\$14.59	F0-1201000

**Blue Water Marine Alkyd 50™**



- A single component marine grade alkyd finish.
- High gloss and good color retention.
- Fast drying and good leveling characteristics.
- Good resistance to chemicals cleaners and abrasion.

Order No.	Mfg. No.	Color	Size	List Price	
759502	(BWC3035G)	White Primer	Gallon	\$70.89	F0-2694000

**Blue Water Rusty Metal Primer™**



- Commercial/Industrial Only.
- Apply over rusty steel, clean steel, galvanized, zinc, aluminum or painted surfaces.
- Locks rust in place.
- Can be overcoated with Marine Alkyd 50 or Marine Urethane Finishes.

Order No.	Mfg. No.	Color	Size	List Price	
759540	(BWC5905G)	Gray	Gallon	\$74.29	F0-0025000



**SPECIAL HANDLING MAY APPLY**



- Electronics
- Trolling Motors
- Instruments
- Electrical
- Lighting
- Anchor & Dock
- Safety
- Steering, Controls
- Pumps
- Fuel System
- Seating & Pedestals
- Trailer
- Tops & Covers
- Perform.
- Propellers
- Engine & Care
- Cleaning & Care
- Paint & Paint Acc.
- Fun & Flotation
- Topside Acc.
- Cockpit & Deck
- Hardware, Fasteners
- Camouflage
- Misc.
- Comm.



# FEAR NO FOULING

**THE MOST  
ADVANCED  
& POWERFUL  
ANTIFOULING  
PAINT EVER  
MADE.**

AVAILABLE IN THESE COLORS

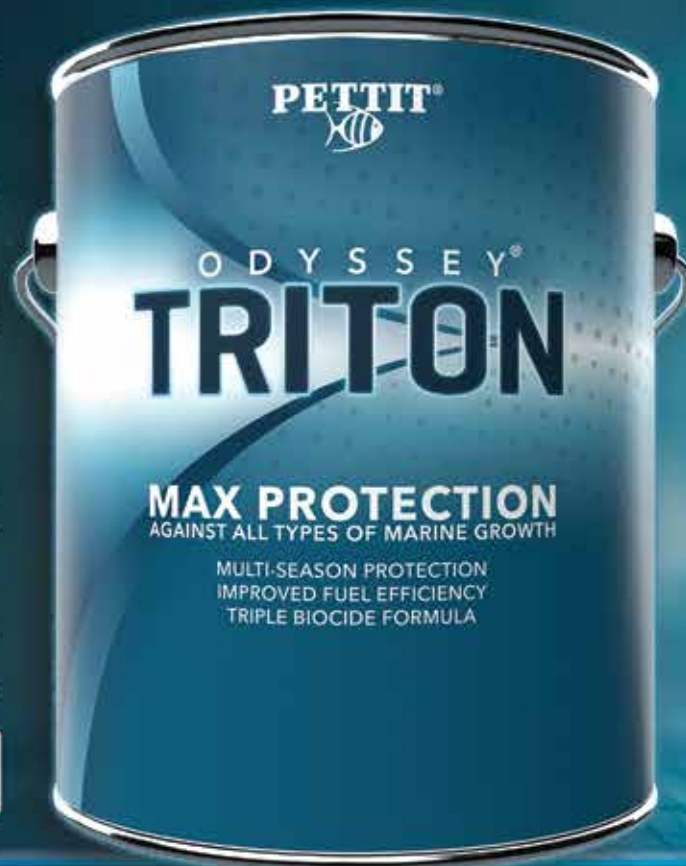

**PROTECTS AGAINST ALL MARINE GROWTH  
MULTI-SEASON ABLATIVE PROTECTION  
MAXIMUM FUEL EFFICIENCY  
TRIPLE BIOCIDES FORMULA**



**COMBO PACK REBATE OFFER:  
\$50 BACK PER COMBO**

WHEN YOU PURCHASE  
ODYSSEY® TRITON &  
RUNNING GEAR GUARDIAN™  
(BOAT OWNERS ONLY - LIMIT 2 COMBOS)

**PETTIT**

800-221-4466

WWW.PETTITPAINT.COM

[www.repuestoselnavegante.com](http://www.repuestoselnavegante.com)

*El Navegante*



## HYDROCOAT TECHNOLOGY ANTIFOULING

**HYDROCOAT®** Water-Based Ablative Paints have fewer VOC's, no foul smell and clean-up is simple with soap and water. Yet with all this green going for it, Hydrocoat® is a very effective antifouling and is as good as the best solvent-based bottom paints. Hydrocoat® can be applied over any other bottom paint without any preparation. Hydrocoat® makes everything easier, from painting, to clean-up, to breathing.



**Hydrocoat®** offers excellent multi-season protection against all types of fouling. Its innovative technology replaces the harsh solvents found in most bottom paints with water, resulting in an easier application and clean up, with no heavy solvent smell. Hydrocoat®'s ablative surface wears away with use, exposing fresh biocide while eliminating paint build-up and the need for sanding. Its unlimited dry time to launch allows for painting in the fall.



**Hydrocoat® ECO** Self-polishing, water-based ablative technology with organic Ecomea® biocide. Hydrocoat® Eco utilizes the highest level of new metal-free Ecomea® biocide available combined with a slime fighting inhibitor for unprecedented multi-season protection. This copper-free formula is compatible over almost all bottom paints and is safe for use on all substrates including steel and aluminum.



## ODYSSEY® MULTI-SEASON ABLATIVE ANTIFOULING

**Odyssey®** Solvent-Based Antifouling Paints wear away with use exposing new biocides. Both the biocides and the paint film disappear over time. These paints can be used multi-season and maintain a more steady performance throughout their useful life. These paints require movement of the boat in order to work. Works similar to a bar of soap by polishing away with use.



**Odyssey® Triton** delivers exceptional, multi-season, tri-biocide performance by combining the proven reliability of Copper Thiocyanate, the impressive strength of ECONEA®, and the versatile organic boosting biocide Zinc Omadine. This combination makes Odyssey® Triton effective against all types of fouling found in the harshest of marine environments.



**Odyssey® 60** delivers exceptional, multi-season, performance against fouling by offering the highest copper content in an ablative available. With significantly more copper than many competitors, Odyssey® 60 offers stronger protection at a better value. Fast dry technology provides quick turnaround and increased production for all applicators.



**Odyssey® HD** multi-season antifouling combines controlled polishing ablative technology with a high copper content to provide a paint film strong enough to handle the tough marine environment from coast to coast. Odyssey® HD is compatible over most finishes and will not build up over time, leaving running surfaces smooth and clean. Odyssey® HD's copolymer resins withstand hauling and relaunching without losing effectiveness for both power and sailboats.



### PETTIT BOTTOM PAINT COMPATIBILITY CHART

This chart is intended as a guide only, additional preparation may be involved due to condition and age of the substrate. For additional paints or other preparation information, contact us at: 800-221-4466 or www.pettitpaint.com

	EXISTING BOTTOM PAINT	HARD ANTIFOULING	DURABLE ABLATIVE	SOFT ABLATIVE	MODIFIED ANTIFOULING	FRESHWATER ANTIFOULING
		Baltoplate Black Widow® Bottomkote Aqua Bottom Pro Gold! BottomShield Defense Vivid® Epoxy Cop Sharkskin Talon Trinidad® (All) Tropikote Ultra Ultra-Kote Unepoxy (All) VC Offshore	Cukote Hydrocoat® (All) Horizons Micron® CSC Micron® Extra Micron® Optima Neptune 5 PCA Gold! Trilux 33 Ultima® SR-40 Odyssey® 60	Ablative Plus AF-33 ACT Aqua-One Bottomkote NT CPP Micron® CF Micron® Optima Micron® WA Monterey Pacifica Plus™ Proguard Ablative Smart Solution™ Super B Ablative Ultima® Eco Armor	Biocop TF* Bottomkote Pro Micron® 99* Micron® 66* Seamate Ultima® 55A Islands 44 TF* Tropikote EX* Islands 44 Plus* Biotin Plus*	FW 21 VC 17 SR 21 VMG
NEW BOTTOM PAINT	Black Widow® Trinidad® (All) Vivid®	SAND & APPLY	HEAVY SAND & APPLY	REMOVE	REMOVE	REMOVE
	ECO HRT® Premium HRT® Unepoxy HRT®	SAND & APPLY	LIGHT SAND & APPLY	LIGHT SAND & APPLY	SAND & APPLY	REMOVE
	Odyssey® HD Ultima® SR-40 Odyssey® 60 Odyssey® Triton	SAND & APPLY	LIGHT SAND & APPLY	SAND & APPLY	HEAVY SAND & APPLY	REMOVE
	Hydrocoat® Hydrocoat® Eco Neptune HRT®	LIGHT SAND & APPLY	POWERWASH & APPLY	LIGHT SAND & APPLY	SAND & APPLY	SAND & APPLY
	SR-21™	SAND & APPLY	REMOVE	REMOVE	REMOVE	CLEAN & APPLY

\*Tin copolymer paints and modified antifouling paints (SPC technology) should be sealed with a coat of 6627 Tie Coat Primer, allow to dry 4 hours and apply new antifouling paint. This document is intended as a guide only, additional preparation may be involved due to condition and age of substrate.



## TRINIDAD\* HARD ANTI FOULING

TRINIDAD\* products have a proven track record of dependable antifouling performance, the active ingredient leaches out while the paint film stays mostly intact. Trinidad\* products do not require movement and work equally well at the dock and underway. Trinidad\* harnesses the power of an extremely high load of biocides to combat even the most extreme fouling conditions.



**Trinidad\*PRO** - the standard by which all bottom paints are measured. It remains the longest lasting, strongest antifouling paint available. Trinidad\*PRO provides unprecedented resistance to all fouling. Its hard protective coating has excellent adhesion, and withstands the toughest abuse. Left in the water, it will provide years of dependable service.



**Trinidad\* 75** - with a proven track record of dependable antifouling performance, Trinidad\* 75 has earned its reputation as one of the most respected names in the industry. Trinidad\* 75 harnesses the power of an extremely high load of cuprous oxide, to combat even the most extreme fouling conditions. Trinidad\* 75's durable, hard epoxy finish has excellent adhesion, and when left in the water, will provide years of dependable service. The antifouling of choice for professional applicators everywhere.



**Trinidad\* HD** provides excellent, long lasting protection, even under the toughest antifouling conditions. Trinidad\*HD provides dependable in-water antifouling protection while meeting the 330 gram per liter VOC regulations. Trinidad\*HD does not require movement and works equally as well at the dock or underway. It's durable hard modified epoxy finish has excellent adhesion, and is highly abrasion resistant. A good choice for powerboat or sailboat use in tropical and other warm waters where extreme fouling exists.



## UNDERWATER METAL PROTECTION



**Running Gear Guardian™** is designed to prevent fouling on all underwater metal running gear such as propellers, trim tabs, propeller shafts and rudder, prop struts, sail drives, strainers, bow and stern thrusters and other underwater metal or running gear by providing incredibly effective and long-lasting protection. Even low levels of fouling on running surfaces can cause efficiency losses up to 20%.



BLACK - 1870

## HRT\* - HYBRID REACTIVE TECHNOLOGY

HRT\* - Hybrid Reactive Technology features high density biocide utilization to maximize effectiveness by using biocide more effectively along with film modifiers to reduce yearly build-up, maintain uniform color consistency, and lower weight while providing a smoother finish than traditional paints. These film modifiers also increase coverage by 25% and continues working whether the vessel is stationary or in motion.



**Premium HRT\*** multi-season high copper antifouling uses the latest technology available to create a hybrid paint film strong enough to handle the tough marine environment without building up over time. Equally effective on both power and sailboats, Premium HRT\* provides excellent antifouling protection without the costs associated with high end antifoulants. Its ease of use, impressive coverage, and attractive price tag make it an excellent choice for use as a boatyard's "house paint".



**ECO HRT\*** copper-free antifouling uses the latest technology available to create a hybrid paint film strong enough to handle the tough marine environment without building up over time. ECO HRT\* smooth durable paint surface wears away over time, eliminating paint film build up and the need for sanding. This copper-free formula can be safely applied to all aluminum-hulled boats. It provides excellent antifouling protection and can be hauled and re-launched without any loss of effectiveness.



**Neptune HRT\*** water-based antifouling uses the latest technology available to create a hybrid paint film strong enough to handle the tough marine environment. Soap and water clean up along with no strong solvent smell, yields a user-friendly application. Neptune HRT\* does not require sanding between coats saving time and money. With low VOC it's ideal for marinas under restrictions. Neptune HRT\* can be used over all previously painted surfaces.



**Unepoxy HRT\*** seasonal antifouling uses the latest technology available to create a hybrid paint film strong enough to handle the tough marine environment without building up over time. It is a dependable antifouling paint formulated to provide outstanding protection at a very affordable price. Its smooth durable finish is able to withstand beaching, trailering, and season long abuse.



## HOW MUCH BOTTOM PAINT DO I NEED?

- 1 Calculate the square footage of the hull to be painted - multiply the length of the hull by the beam then multiply that total by .85



$$\text{Length} \times \text{Beam} \times .85 = \text{Square Feet of Hull}$$

- 2 Divide that number (your square foot total) by the amount of coverage the selected bottom paint offers. This will give you a one-coat total.



## ANTIFOULING SPEEDCOATING



**Vivid®** offers the brightest colors, the blackest black and the whitest white available. Dual biocides provide excellent multi-season protection. Hybrid technology incorporates all the benefits of ablative and hard paints in one. Its hard, smooth surface withstands trailering and is easily burnished to a high performance racing finish. Vivid resists build-up and can be hauled and relaunched without repainting. Safe for use on properly primed aluminum. The perfect choice for any boat.



**Black Widow®** is the slickest, fastest, ultra-smooth burnishable racing finish available. Its powerful dual-biocides provide multi-season protection in all waters. Black Widow® is easily applied by roller, brush, or spray and is easily burnishable to a metallic "gun-metal" shine. Black Widow® makes an excellent paint for the bottom of any boat where speed is the number one priority, including racing sailboats, and high performance offshore powerboats. Black Widow® contains four strong slickening agents: Molybdenum Disulfide, PTFE, Graphite and Silicon.



DARK BLUE - 1269    BLACK - 1869

### Vivid Base Colors



WHITE - 1161

BLUE - 1261

GREEN - 1361

YELLOW - 1461

RED - 1661

BLACK - 1861

### Vivid Mixed Colors



4 White / 1 Yellow

1 White / 1 Yellow

4 Yellow / 1 White

1 Red / 1 Yellow

4 Yellow / 1 Red

1 Red / 1 White

1 Red / 4 White

4 Yellow / 1 Blue

1 Yellow / 1 Blue

4 Blue / 1 Yellow

4 Green / 1 Yellow

1 Green / 1 White

1 Blue / 4 White

4 Blue / 1 Red

1 Blue / 1 Red

1 Blue / 4 Red

4 White / 1 Black

1 Black / 1 White

Note: All swatch colors shown in this brochure are approximations of the actual paint color in the can or mixes.

## EPOXY PRIMER BARRIER COAT

### Pettit Protect® - 2 Coat Barrier Coat



#### High-Build Epoxy Primers -

- Faster and easier application
- Comprehensive gelcoat blister repair and prevention
- High-build formula covers in 2 coats vs the competitions 5 or 6 coats
- Exclusive low-VOC formula developed specifically for friendly application



GRAY - 4700/4701



WHITE - 4100/4101

**Pettit Protect®** is a heavy duty, two component, epoxy coating for use where maximum resistance to fresh or salt water is required. It reduces water absorption making it an excellent choice for osmotic blister prevention and repair. Its high-solids formula allows for quicker and easier application with fewer coats necessary for effective protection. It also offers dependable corrosion protection on all underwater metals.

### What makes Pettit Protect® different?

**Pettit Protect®** uses significantly more of the waterproofing agent MICA. MICA at the highest concentration possible provides excellent protection from water intrusion.



## PROPELLER AND SHAFT



**Prop Coat Barnacle Barrier® 1792** provides protection for bare metals including steel, stainless steel, cast iron, copper, bronze, galvanized steel, and lead. It forms an excellent bond to underwater metals and running gear, and inhibits corrosion on these surfaces. Prop Coat Barnacle Barrier®'s smooth, hard surface will self-clean in service, and can be used above or below the waterline. The dried film of Prop Coat contains the highest percentage of pure Zinc.

## CLEANERS / DEWAXERS



**Bio-Blue Hull Surface Prep 92** de-waxes, cleans, and prepares bare fiberglass for painting. Easily removes unwanted contaminants and mold release agents prior to painting. When used with 4700/4701 Pettit Protect® and antifouling paint, it is part of an easy 1-2-3 system.

PETTIT ABLATIVE ANTIFOULING PAINTS

Pettit Ultima® SR-60 Ablative Antifouling Paint

PETTIT



- Dual biocides provide exceptional, multi-season, performance.
- Provides unmatched multi-season performance.
- High copper content yields best protection and longevity in high fouling areas.
- Slime release technology combines high biocide load with PTFE for better performance.
- **Thinner:** 185 Ablative Thinner.

Order No.	Mfg. No.	Color	Size	List Price	
732510	(1032GL)	Blue	Gallon	\$369.79	E0-4377200
732512	(1033GL)	Green	Gallon	\$369.79	E0-4377200
732514	(1036GL)	Red	Gallon	\$369.79	E0-4377200
732516	(1038GL)	Black	Gallon	\$369.79	E0-4377200

Pettit Odyssey HD Multi-Season Ablative Antifouling Paint

PETTIT



- Fast dry, VOC compliant standard for boatyards.
- High-copper ablative protection in all waters.
- Smooth polishing finish prevents buildup and sanding.
- Compatible over most bottom paints.
- Covered by HD (Hull Defense) 18 Month Limited Warranty.
- **Thinner:** 120 Brushing Thinner or 121 Spray Thinner.

Order No.	Mfg. No.	Color	Size	List Price	
732657	(1207GL)	Blue	Gallon	\$241.69	E0-7218100
732671	(1307GL)	Green	Gallon	\$241.69	E0-7218100
732695	(1607GL)	Red	Gallon	\$241.69	E0-7218100
732710	(1807GL)	Black	Gallon	\$241.69	E0-7218100

Pettit Premium HRT Multi-Season Antifouling Paint

PETTIT



- Multi-Season Antifouling Paint.
- High-copper hybrid protection.
- Smooth durable polishing finish.
- Compatible over most bottom paints.
- **Thinner:** 120 Brushing Thinner or 121 Spray Thinner.

Order No.	Mfg. No.	Color	Size	List Price	
736504	(1219GL)	Blue	Gallon	\$141.19	E0-9850100
736528	(1319GL)	Green	Gallon	\$141.19	E0-9850100
736542	(1619GL)	Red	Gallon	\$141.19	E0-9850100
736566	(1819GL)	Black	Gallon	\$141.19	E0-9850100

Pettit Ultima® SR-40 Multi-Season Ablative Antifouling Paint

PETTIT



- Dual biocides with 40% copper for outstanding fouling control.
- Unique controlled wear rate minimizes build up and keeps surfaces smooth.
- Multi-season ablative technology provides a continuous supply of fresh biocides.
- Slime release technology combines high biocide load with PTFE for better performance.
- **Thinner:** 120 Brushing Thinner.

Order No.	Mfg. No.	Color	Size	List Price	
732560	(1098GL)	Black	Gallon	\$313.09	E0-2843200

Pettit Odyssey Triton Ablative Antifouling Paint

PETTIT



- Three biocides provide unparalleled multi-season protection in the harshest environments.
- Maximum fuel efficiency and reduced build-up.
- Maximum protection against all types of marine growth.
- Compatible over most bottom paints.
- Covered by the enhanced HD (Hull Defense) 24 Month Limited Warranty.

Order No.	Mfg. No.	Color	Size	List Price	
732746	(1299GL)	Blue	Gallon	\$403.29	E0-7420300
732809	(1899GL)	Black	Gallon	\$403.29	E0-7420300

Pettit Horizons Multi-Season Ablative Antifouling Paint

PETTIT



- High copper load for multi-season protection in all conditions.
- Ablative technology eliminates sanding and buildup.
- Greater antifouling protection at a lower cost.
- The standard ablative for many boatyards.
- **Thinner:** 120 Brushing Thinner or 121 Spray Thinner.

Order No.	Mfg. No.	Color	Size	List Price	
733820	(1250GL)	Blue	Gallon	\$184.39	C0-3765100

SPECIAL HANDLING MAY APPLY

- Electronics
- Trolling Motors
- Instruments
- Electrical
- Lighting
- Anchor & Dock
- Safety
- Steering, Controls
- Pumps
- Fuel System
- Seating & Pedestals
- Trailer
- Tops & Covers
- Perform.
- Propellers
- Engine & Care
- Cleaning & Care
- Paint & Paint Acc.
- Fun & Flotation
- Topside Acc.
- Cockpit & Deck
- Hardware, Fasteners
- Camouflage
- Misc.
- Comm.



**PETTIT ABLATIVE WATER BASED ANTIFOULING PAINTS**

**Pettit Hydrocoat® SR Water-Based Dual Biocide Antifouling Paint**

PETTIT

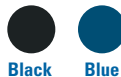

- The best just got better with added slime resistance.
- Dual-Biocides provide outstanding multi-season protection.
- Ablative, self-polishing technology eliminates sanding and paint build-up.
- Easy to apply and cleans up with soap and water.
- **Thinner:** Water.

Order No.	Mfg. No.	Color	Size	List Price	
732485	(1247GL)	Blue	Gallon	\$238.69	CO-9820200
732493	(1847GL)	Black	Gallon	\$238.69	CO-9820200

**Pettit Hydrocoat® Water-Based Multi-Season Antifouling Paint**

PETTIT



- Simply the best water-based ablative multi-season protection.
- Ablative, self polishing technology eliminates sanding and paint build-up.
- Environmentally friendly, easy to apply and cleanup with soap & water.
- Unlimited dry time to launch, can be painted in the fall or winter.
- **Thinner:** Water.

Order No.	Mfg. No.	Color	Size	List Price	
732467	(1240GL)	Blue	Gallon	\$237.29	E0-7977100
732470	(1340GL)	Green	Gallon	\$237.29	E0-7977100
732481	(1640GL)	Red	Gallon	\$237.29	E0-7977100
732479	(1840GL)	Black	Gallon	\$237.29	E0-7977100

**Pettit Hydrocoat® ECO Water-Based Multi-Season Antifouling Paint**

PETTIT



- Water-based, copper-free, self-polishing ablative antifouling paint.
- Co-polymer ablative technology eliminates sanding and paint build-up.
- Dual-biocides provide outstanding multi-season protection in all conditions.
- Uses the power of organic ECONEA for better protection and a greener earth.
- **Thinner:** Water.

Order No.	Mfg. No.	Color	Size	List Price	
732586	(1204GL)	Blue	Gallon	\$327.59	E0-9654200
732588	(1204Q)	Blue	Quart	\$73.59	CO-5526000
732594	(1304Q)	Green	Quart	\$72.19	CO-6316000
732604	(1804GL)	Black	Gallon	\$327.59	E0-9654200
732606	(1804QT)	Black	Quart	\$109.89	E0-2428000

**Pettit Neptune HRT Water-Based Antifouling Paint**

PETTIT



- Water-Based Antifouling Paint.
- Economical hybrid protection.
- Smooth durable polishing finish.
- Apply over most antifouling paints.
- Simple soap and water clean up.
- **Thinner:** 140 Water-Based Brushing Thinner.

Order No.	Mfg. No.	Color	Size	List Price	
737265	(1243GL)	Blue	Gallon	\$123.79	E0-4829000
737289	(1343GL)	Green	Gallon	\$123.79	E0-4829000
737304	(1643GL)	Red	Gallon	\$123.79	E0-4829000
737328	(1843GL)	Black	Gallon	\$123.79	E0-4829000

**PETTIT HARD ANTIFOULING PAINTS**

**Pettit Trinidad PRO Hard Antifouling Paint with Slime Resistant**

PETTIT



- Trinidad PRO formula in our Pro Coatings line available to professional applicators.
- Dual biocides with high copper load (70%) offers unprecedented protection.
- Hard durable finish for long lasting performance.
- **Thinner:** 120 Brushing Thinner or 121 Spray Thinner.

Order No.	Mfg. No.	Color	Size	List Price	
736908	(1082GL)	Blue	Gallon	\$323.29	E0-7424200
736922	(1083GL)	Green	Gallon	\$323.29	E0-7424200
736946	(1086GL)	Red	Gallon	\$323.29	E0-7424200
736960	(1088GL)	Black	Gallon	\$323.29	E0-7424200

**Pettit Trinidad HD Multi-Season Hard Antifouling Paint**

PETTIT



- Fast-Dry Technology.
- High copper load offers excellent performance in all conditions.
- Hard, durable, finish for long lasting performance.
- Excellent adhesion to fiberglass, wood and steel hulls.
- Covered by HD (Hull Defense) 18 Month Limited Warranty.
- **Thinner:** 120 Brushing Thinner or 121 Spray Thinner.

Order No.	Mfg. No.	Color	Size	List Price	
737013	(1271GL)	Blue	Gallon	\$241.69	E0-7218100
737051	(1671GL)	Red	Gallon	\$241.69	E0-7218100
737075	(1871GL)	Black	Gallon	\$241.69	E0-7218100



**SPECIAL HANDLING MAY APPLY**



- Electronics
- Trolling Motors
- Instruments
- Electrical
- Lighting
- Anchor & Dock
- Safety
- Steering, Controls
- Pumps
- Fuel System
- Seating & Pedestals
- Trailer
- Tops & Covers
- Perform.
- Propellers
- Engine & Care
- Cleaning & Care
- Paint & Paint Acc.
- Fun & Flotation
- Topside Acc.
- Cockpit & Deck
- Hardware, Fasteners
- Camouflage
- Misc.
- Comm.

**PETTIT HARD ANTIFOULING PAINTS**

**Pettit Unepoxy HRT Seasonal Antifouling Paint**

**PETTIT**



- Seasonal Antifouling Paint.
- Economical hybrid protection.
- Smooth durable polishing finish.
- Compatible over most bottom paints.
- **Thinner:** 120 Brushing Thinner or 121 Spray Thinner.

Order No.	Mfg. No.	Color	Size	List Price	
736801	(1211GL)	Blue	Gallon	\$109.19	E0-9818000
736819	(1211QT)	Blue	Quart	\$35.69	E0-7762000
736821	(1311GL)	Green	Gallon	\$109.19	E0-9818000
736845	(1611GL)	Red	Gallon	\$109.19	E0-9818000
736869	(1811GL)	Black	Gallon	\$109.19	E0-9818000
736871	(1811QT)	Black	Quart	\$35.69	E0-7762000

**Pettit Trinidad 75 Hand Antifouling Paint for Professional Applicators**

**PETTIT**

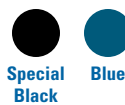

- Trinidad formula in our Pro Coatings line available to professional applicators.
- Proven track record of unparalleled performance.
- Designed for extreme fouling conditions with a high copper load.
- Left in the water, Trinidad 75 provides classic, year-round service.
- **Thinner:** 120 Brushing Thinner or 121 Spray Thinner.

Order No.	Mfg. No.	Color	Size	List Price	
732392	(1074GL)	Blue	Gallon	\$279.59	E0-9690200
732455	(1079GL)	Special Black	Gallon	\$279.59	E0-9690200

**PETTIT ALUMINUM BOAT ANTIFOULING PAINTS**

**Pettit Vivid Hybrid Multi-Season Dual Biocide Antifouling Paint**

**PETTIT**



- Hybrid technology offers all the advantages of ablative and hard paints.
- Clean, bright colors including true white and black.
- Dual-biocides provide excellent multi-season protection.
- Excellent for Racing, Trailering or Rack Stored Boats.
- Also, excellent for aluminum boats.
- **Thinner:** 120 Brushing Thinner or 121 Spray Thinner.

Order No.	Mfg. No.	Color	Size	List Price	
733611	(1161GL)	White	Gallon	\$334.89	E0-7115200
733613	(1161QT)	White	Quart	\$112.79	E0-9548000
733623	(1261GL)	Blue	Gallon	\$334.89	E0-7115200
733627	(1261QT)	Blue	Quart	\$114.29	E0-2758000
733635	(1361GL)	Green	Gallon	\$358.19	E0-4686200
733659	(1661GL)	Red	Gallon	\$334.89	E0-7115200
733661	(1861GL)	Black	Gallon	\$334.89	E0-7115200
733673	(1861QT)	Black	Quart	\$112.79	E0-9548000

**Pettit ECO HRT Copper-Free Antifouling Paint**

**PETTIT**



- Copper-Free Antifouling Paint.
- Economical hybrid protection.
- Smooth durable polishing finish.
- Compatible over most bottom paints.
- Can be safely applied to all aluminum-hulled boats.
- **Thinner:** 120 Brushing Thinner or 121 Spray Thinner.

Order No.	Mfg. No.	Color	Size	List Price	
737102	(1200GL)	Blue	Gallon	\$168.89	E0-7662100
737126	(1300GL)	Pontoon Gray	Gallon	\$168.89	E0-7662100
737140	(1800GL)	Black	Gallon	\$168.89	E0-7662100
737152	(1800SC)	Black	12 oz. (Spray)	\$36.39	E0-9272000

**PETTIT SAILBOAT ANTIFOULING PAINTS**

**Pettit Black Widow Racing Finish Antifouling Paint**

**PETTIT**



- Contains four slickening agents: Molybdenum Disulfide, PTFE, Graphite and Silicon.
- Slickest, fastest, and easiest to clean racing paint.
- Provides high performance, multi season, dual biocide antifouling protection.
- Can be polished to a mirror-like finish.
- **Thinner:** 120 Brushing Thinner or 121 Spray Thinner.

Order No.	Mfg. No.	Color	Size	List Price	
733166	(1269GL)	Dark Blue	Gallon	\$356.69	E0-2576200
733215	(1869GL)	Black	Gallon	\$362.59	E0-4917200

**SPECIAL HANDLING MAY APPLY**



Electronics

Trolling Motors

Instruments

Electrical

Lighting

Anchor & Dock

Safety

Steering, Controls

Pumps

Fuel System

Seating & Pedestals

Trailering

Tops & Covers

Perform.

Propellers

Engine & Care

Cleaning & Care

Paint & Paint Acc.

Fun & Flotation

Topside Acc.

Cockpit & Deck

Hardware, Fasteners

Camouflage

Misc.

Comm.

**Pettit Alumaspray + Antifouling Paint**



- For Aluminum Outdrives & Outboards.
- Contains no copper compounds-will not cause galvanic corrosion.
- Advance Slime Resistance.
- May be hauled and relaunched without recoating.

Order No.	Mfg. No.	Color	Size	List Price
733798	(1863EA)	Black	12 oz.	\$37.09 E0-2872000

**Pettit Copper Guard Antifouling Paint**



- Unepoxy Standard formula in our Pro Coatings line available to professional applicators.
- Contains the highest copper load in its class.
- Excellent coverage, adhesion, and compatibility.
- **Thinner:** 120 Brushing Thinner or 121 Spray Thinner.

Order No.	Mfg. No.	Color	Size	List Price
732366	(1042GL)	Blue	Gallon	\$95.49 C0-7118000

**Pettit EZ Prime Topside Paint Undercoater**



- Should be used as a base coat whenever the surface to be painted is aged, cracked, checked, pitted, or in any way less than smooth.
- It can be applied to fiberglass, wood and previously painted surfaces.
- Excellent filling properties which can be used for a full, one-coat application.
- **Thinner:** 120 Brushing Thinner or 121 Spray Thinner.

Order No.	Mfg. No.	Color	Size	List Price
734699	(6149GL)	White	Gallon	\$89.69 E0-7276000
734702	(6149QT)	White	Quart	\$31.99 E0-9932000

**Pettit EZ Decks - Non-Skid Deck Paint**



- It contains a silica grit that produces a slip-resistant finish on all decks and cabin soles.
- The durable weather resistant finish resists long term abrasion and abuse.
- Loaded with ultraviolet filters to fight against fading while offering superior color retention that will stay vibrant for years without peeling or cracking like other deck finishes.
- **Thinner:** 120 Brushing Thinner.

Order No.	Mfg. No.	Color	Size	List Price
734081	(3127GL)	White	Gallon	\$116.59 E0-4478000
734082	(3127QT)	White	Quart	\$28.69 C0-9342000
734087	(3129GL)	Gray	Gallon	\$116.59 E0-4478000

**Pettit Neptune5 Hybrid Antifouling Paint**



- Durable, smooth, thin-film finish resists build up.
- Compatible over all bottom paints.
- Simple soap and water clean up.
- Thinner: Water.

Order No.	Mfg. No.	Color	Size	List Price
733208	(1243GL)	Blue	Gallon	\$122.59 E0-4919000

**Pettit EZ-Poxy Modern Polyurethane Topside Paint**



- A modern one-part polyurethane topside and deck enamel improved by the addition of silicone for a brilliant shine and easy brush-ability.
- Its advanced ultraviolet filters enhance the superior gloss retention and durability of polyurethane.
- The result is a topside finish that's exceptionally easy to apply, producing a lasting gelcoat-like brilliance with a minimum of effort.
- Formerly Easyoxo.
- **Thinner:** 120 Brushing Thinner or 121 Spray Thinner.

Order No.	Mfg. No.	Color	Size	List Price
734031	(3106GL)	Semi-Gloss White	Gallon	\$113.59 E0-9158000
734043	(3106QT)	Semi-Gloss White	Quart	\$42.19 E0-4613000
734055	(3108GL)	Hatteras Off-White	Gallon	\$119.39 E0-4598000
734067	(3108QT)	Hatteras Off-White	Quart	\$42.19 E0-4613000
734093	(3175GL)	White	Gallon	\$113.69 E0-7258000
734106	(3175QT)	White	Quart	\$42.19 E0-4613000
734168	(3213QT)	Blue Ice	Quart	\$46.29 E0-2743000
734221	(3229QT)	Bikini Blue	Quart	\$45.09 E0-2833000
734269	(3237QT)	Electric Sapphire Blue	Quart	\$45.09 E0-2833000
734295	(3248QT)	Ocean Blue	Quart	\$45.09 E0-2833000
734310	(3303QT)	Dull Dead Grass	Quart	\$33.19 E0-9842000
734334	(3333QT)	Seafoam Green	Quart	\$44.79 E0-9533000
734346	(3348QT)	Jade Green	Quart	\$43.39 E0-4523000
734360	(3350QT)	Kelly Green	Quart	\$44.79 E0-9533000
734423	(3518QT)	Sandtone	Quart	\$45.09 E0-2833000
734461	(3624QT)	Fire Red	Quart	\$49.49 E0-2173000
734485	(3626QT)	Burgundy	Quart	\$50.79 E0-9083000
734550	(3711GL)	Platinum	Gallon	\$126.69 E0-2059000
734562	(3711QT)	Platinum	Quart	\$45.09 E0-2833000
734586	(3720QT)	Steel Gray	Quart	\$43.39 E0-4523000
734625	(3801QT)	Black	Quart	\$42.89 E0-7123000

**SKIDLESS COMPOUND**

- A dry powder which may be added to any Pettit Topside Paint to produce a rough textured finish.

Order No.	Mfg. No. / Description	List Price
736249	(9900PT) Pint	\$23.29 E0-7471000



**SPECIAL HANDLING MAY APPLY**



- Electronics
- Trolling Motors
- Instruments
- Electrical
- Lighting
- Anchor & Dock
- Safety
- Steering, Controls
- Pumps
- Fuel System
- Seating & Pedestals
- Trailer
- Tops & Covers
- Perform.
- Propellers
- Engine & Care
- Cleaning & Care
- Paint & Paint Acc.
- Fun & Flotation
- Topside Acc.
- Cockpit & Deck
- Hardware, Fasteners
- Camouflage
- Misc.
- Comm.



PETTIT UNDERWATER METAL PROTECTION

Pettit Running Gear Guardian



- Superior underwater metal protection.
- Multi-season dual biocide formula prevents all fouling.
- Easiest application with long lasting results.
- Excellent adhesion and corrosion protection.
- Durable, slick, ultra-smooth finish.
- Increased fuel efficiency.
- For use on ALL underwater metals; propellers, rudders, trim tabs, propeller shafts, strainers, sail drives, struts, bow & stern thrusters.
- Will cover 65 sq. ft. of underwater metals.

Order No.	Mfg. No. / Description	List Price
<b>733750</b>	(1870)	<b>\$181.99</b> E0-9463100

Pettit Prop Coat Barnacle Barrier



- Provides superior underwater metal corrosion protection.
- Excellent adhesion to clean metals.
- Dried paint film contains the highest amount of pure zinc available.
- It's smooth, hard surface will self-clean in service and can be used above and below the waterline.
- Fast dry formula in an easy to use aerosol spray can or quart for large applications.

Order No.	Mfg. No. / Description	List Price
<b>733801</b>	(1792SC) 20 oz.	<b>\$29.79</b> E0-4322000
<b>733813</b>	(1792QT) Quart	<b>\$93.39</b> E0-4007000

PETTIT PRIMERS

Pettit Protect High Build Epoxy Primer



- A heavy duty, two component, epoxy coating for use where maximum resistance to fresh or salt water is required.
- It reduces water absorption making it an excellent choice for osmotic blister prevention and repair.
- Its high-solids formula allows for quicker and easier application with fewer coats necessary for effective protection.
- Higher-solids equals 3 coat application instead of 6 needed by competitive products.
- It also offers dependable corrosion protection on all underwater metals.
- Use 97 Epoxy Thinner is needed.

WHITE		
Order No.	Mfg. No. / Description	List Price
<b>735321</b>	(4100/4101GL) Gallon Set	<b>\$121.69</b> E0-7219000

GRAY		
Order No.	Mfg. No. / Description	List Price
<b>735324</b>	(4700/4701GL) Gallon Set	<b>\$120.09</b> E0-7009000
<b>735336</b>	(4700/4701QT) Quart Set	<b>\$42.89</b> E0-7123000

Pettit Rustlok Steel Primer



- An easy to apply, moisture and corrosion proof primer for use on all cast iron and steel surfaces, including galvanized, stainless.
- Its water impervious barrier offers excellent adhesion and corrosion protection even over rusted surfaces.
- Use 120 thinner for brushing, rolling and clean-up.

Order No.	Mfg. No. / Description	List Price
<b>735235</b>	(6980GL) Gallon	<b>\$121.59</b> E0-9119000
<b>735247</b>	(6980QT) Quart	<b>\$43.69</b> E0-7723000

Pettit Tie Coat Primer



- A general purpose, chlorinated rubber primer for use on metal surfaces and as a tie coat between different types of coatings.
- Can be used above and below the waterline.
- When used over Pettit 6455/044 Metal Primer, it forms an excellent, easy to use system for use on all underwater running gear.
- Use Epoxy Thinner 97 to thin if necessary.

Order No.	Mfg. No. / Description	List Price
<b>735196</b>	(6627GL) Gallon	<b>\$125.69</b> E0-7249000
<b>735209</b>	(6627QT) Quart	<b>\$44.79</b> E0-9533000

Pettit Alumaprotect Aluminum Epoxy Primer



- A 2 part strontium chromate primer designed to form the ideal barrier coat over roughed bare aluminum.
- Alumaprotect provides maximum resistance to fresh or salt water, thus eliminating corrosion.
- This complete coating system resists water, industrial chemical fumes and very humid environments.
- Intended to be used as a primary coat over bare aluminum hulls and outdrives.
- Two coats are recommended over sandblasted aluminum.

Order No.	Mfg. No. / Description	List Price
<b>735174</b>	(4400/4401.75) .75 Gallon	<b>\$129.99</b> E0-9479000

SPECIAL HANDLING MAY APPLY

**PETTIT VARNISHES**

**Pettit Z-Spar Captain's Varnish**



- Highly regarded for its ease of application, outstanding gloss retention and tough yet flexible durability.
- A combination of phenolic and alkyd resins blended with tung and linseed oils provide excellent performance.
- It's warm, light amber hue will enhance the rich, classic bright work appearance.
- Use 120 thinner for brushing, rolling and clean-up. Use 121 thinner for spraying.



Order No.	Mfg. No. / Description	List Price	
380446	(1015GL) Gallon	\$123.79	E0-4829000
380460	(1015QT) Quart	\$40.79	E0-9503000
380458	(1015PT) Pint	\$22.99	E0-4271000

**Pettit Z-Spar Captain's Ultra-Clear Varnish**



- A premium urethane varnish specially formulated for maximum durability and ease of application.
- The strong ultraviolet inhibitors help it maintain outstanding gloss long after ordinary varnishes have faded.
- Provides remarkable resistance against scratching and chipping.
- It's easy brushability, excellent leveling capabilities and fast build-up.
- Use 120 thinner for brushing, rolling and clean-up. Use 121 thinner for spraying.



Order No.	Mfg. No. / Description	List Price	
738003	(2067QT) Quart	\$51.59	E0-9683000

**Pettit Z-Spar Flagship Varnish**



- A special blend of phenolic and alkyd resins combined with tung and linseed oils offer excellent performance and a warm, light amber hue.
- Contains an ultraviolet light filter in conjunction with a light stabilizer to screen the sun's damaging rays for longer life.
- Has the highest build and film depth per coat, as well as excellent abrasion resistance and a high gloss finish.
- Use 120 thinner for brushing, rolling and clean-up. Use 121 thinner for spraying.



Order No.	Mfg. No. / Description	List Price	
380472	(2015QT) Quart	\$45.09	E0-2833000

**Pettit Z-Spar Captain's Satin Varnish**



- Designed to enhance the beauty of interior woodwork with its soft, satin finish.
- Its pale, durable, long lasting polyurethane coat is water and alcohol-resistant.
- Satin Sheen is easy to apply and is intended for interior use only.
- Use 120 thinner for brushing, rolling and clean-up. Use 121 thinner for spraying.



Order No.	Mfg. No. / Description	List Price	
380509	(V975QT) Quart	\$40.79	E0-9503000

**PETTIT EPOXY SYSTEMS AND COMPONENTS**

**Pettit Splash Zone 2-Part Epoxy Compound**



- An extremely hard, abrasion and impact resistant, two-part epoxy patching compound.
- It can be applied in or out of water to repair boat hulls, buoys, seawalls, docks, bridge abutments and more.
- Provides excellent protection against corrosion of metals and erosion and deterioration of concrete or wood.
- Not for use in potable water.

Order No.	Mfg. No. / Description	List Price	
735734	(A-788QT) Quart Set	\$54.39	E0-9704000
735728	(A-788HGS) 1/2 Gallon Set	\$101.69	E0-7267000
735722	(A-788-2GL) 2 Gallon Set	\$233.79	E0-4357100

**Pettit EZ-Fair - Epoxy Fairing Compound**



- EZ-Fair is a lightweight, two-part epoxy putty designed for filling and smoothing surface imperfections above and below the waterline.
- The special resins used in EZ-Fair impart a high degree of water and chemical resistance to the product, making it an integral part of the Pettit Gelcoat Blister Repair System.
- In addition, EZ-Fair is the product of choice for fairing metal keels or any underwater surface.
- Use it for leveling uneven surfaces, filling gouges, scratches or other damage on fiberglass, wood or metal surfaces.
- It's excellent chemical and water resistance make it the ideal choice for repairing blistered gelcoat in an osmotic blister repair system.
- EZ-Fair is non-sagging and non-shrinking and sands to a smooth finish.

Order No.	Mfg. No. / Description	List Price	
735317	(7050QT) Quart	\$73.29	E0-7945000
735319	(7050CRT) 2:1 A/B Mix, 250 ml	\$30.59	E0-4922000



**SPECIAL HANDLING MAY APPLY**



- Electronics
- Trolling Motors
- Instruments
- Electrical
- Lighting
- Anchor & Dock
- Safety
- Steering, Controls
- Pumps
- Fuel System
- Seating & Pedestals
- Trailering
- Tops & Covers
- Perform.
- Propellers
- Engine & Care
- Cleaning & Care
- Paint & Paint Acc.
- Fun & Flotation
- Topside Acc.
- Cockpit & Deck
- Hardware, Fasteners
- Camouflage
- Misc.
- Comm.



Electronics

Trolling Motors

Instruments

Electrical

Lighting

Anchor & Dock

Safety

Steering, Controls

Pumps

Fuel System

Seating & Pedestals

Trailer

Tops & Covers

Perform.

Propellers

Engine & Care

Cleaning & Care

Paint & Paint Acc.

Fun & Flotation

Topside Acc.

Cockpit & Deck

Hardware, Fasteners

Camouflage

Misc.

Comm.

**PETTIT EPOXY SYSTEMS AND COMPONENTS**

**Pettit Flexpoxy - Flexible 2-Part Repair Epoxy**

**PETTIT**

- Flexpoxy is a two-part epoxy resin that does not sag, run or shrink.
- Its thick formula allows it to fill large cavities in a single application.
- When cured, it remains flexible making it ideal for environments that require flex such as keel joint repairs.
- Flexpoxy creates a superior bond to all epoxies, polyester resins, metals and wood.
- It can be sanded, machined, cut, filed, planed, drilled, tapped or nailed making it perfect for filling, filleting, forming, fairing and fastening.
- This low odor formula is resistant to chemicals and is safe to use above and below the waterline.
- Flexpoxy can be molded and shaped during application and is easily tinted with paints and stains.
- Flexpoxy can be over coated by most paints and stains.



Order No.	Mfg. No. / Description	List Price
<b>735300</b>	(7076CRT) 2:1 A/B Mix, 250 ml	<b>\$29.89</b> E0-2422000

**PETTIT WOOD FINISHES**

**Pettit EZ-Wood Sealer**

**PETTIT**

- Seals open wood grain providing a more uniform finish.
- For all woods including teak, mahogany, oak, ash, fir, and plywood.
- Prevents excessive vehicle absorption from primers, paints, or varnishes.
- Excellent penetration into raw wood for improved stability and moisture resistance.



Order No.	Mfg. No. / Description	List Price
<b>380511</b>	(2018QT) Quart	<b>\$30.59</b> E0-4922000

**PETTIT THINNERS**

**Pettit Brushing Thinner #120**

**PETTIT**

- A general purpose thinner.
- Recommended thinner for clean-up of all Pettit, Z\*Spar and Shipendec solvent based topside enamels and varnishes as well as all antifouling paints except for Hydrocoat and Ultima SR-60.



Order No.	Mfg. No. / Description	List Price
<b>735918</b>	(120GL) Gallon	<b>\$54.59</b> E0-4904000
<b>735920</b>	(120QT) Quart	<b>\$22.49</b> E0-7861000

**Pettit Spraying Thinner #121**

**PETTIT**

- A fast evaporating thinner used to reduce most Pettit, Z\*Spar and Shipendec products before spray application.
- This thinner flashes out rapidly.



Order No.	Mfg. No. / Description	List Price
<b>735956</b>	(121QT) Quart	<b>\$23.99</b> E0-9971000

**Pettit Fiberglass Dewaxer**

**PETTIT**

- Fiberglass Dewaxer is a special blend of solvents, formulated to cut through and remove mold release, grease, and previously applied waxes from the gelcoat.
- Can be used above and below the waterline.
- Fiberglass de-waxing is necessary because visible and invisible release agents remain on the hull from the manufacturing process.
- Covers approximately 400 square feet per gallon.



Order No.	Mfg. No. / Description	List Price
<b>736237</b>	(D95GL) Gallon	<b>\$48.79</b> C0-7414000

**Pettit EZ Cabin Coat Interior Paint**

**PETTIT**

- A high performance, water-based paint specially formulated for areas that are prone to moisture.
- Its durable finish easily withstands the humid, challenging conditions that promote unsightly mildew growth and cause paint failures in cabin interiors.
- Provides a moisture resistant, mildew proof finish that will stay good-looking, bright and color-fast for years.
- Ideal for high humidity areas such as cabin interiors, heads, lockers, cabinets, drawers and closets, it can be used on all interior surfaces, such as drywall, wood, fiberglass, wood coverings and even tile.
- Provides excellent adhesion to most glossy surfaces without the need for sanding.



Order No.	Mfg. No. / Description	List Price
<b>734069</b>	(3121QT) White Quart	<b>\$24.19</b> C0-6502000

# Premium Yacht Paint Solutions

## Topside Finishes

### Perfection®

A high-gloss, high-performance two-part polyurethane that combines a long lasting abrasion and chemical resistant finish with superb protection from the detrimental effects of UV rays. Its abrasion resistance makes it ideal for application to decks and gunwales. Perfection can be used anywhere above the true waterline on properly prepared fiberglass, wood, aluminum, steel and epoxy. The superb high-gloss characteristics, long-wasting color retention and durability makes Perfection the finest coating available.



Professional quality results are made easy with Perfection.

Snow White YHB000	Mediterranean White YHA184	Off-White YHA192	Oyster White YHA194	Matterhorn White YHA196
Arctic White YHS248	Pearl White YHS253	Platinum YHA183	Cream YHS070	Fighting Lady Yellow YHS056
Rochele Red YHS299	Jade Mist Green YHB663	Lauderdale Blue YHS936	Royal Blue YHA216	Mauritius Blue YHF991
Flag Blue YHK990	Jet Black YHY999			

### Brightside® Polyurethane

Brightside is a hard, easy to use high-gloss one-part polyurethane topside finish. It has excellent application characteristics that yield a "sprayed on" look when brush applied in thin coats. Brightside is ideal for use anywhere above the true waterline and is easy to clean, resists staining and has great abrasion resistance. Brightside is also available in select colors in pints for striping and boottops.



Blue-Glo White Y4259	White Y4359*	Off-White Y4381	Matterhorn White Y4360	Seattle Gray Y4205
Kingston Gray Y4190	Steel Gray Y4250	Black Y4258*	Light Blue Y4351	Medium Blue Y4353
Largo Blue Y4100	Ocean Blue Y4253 (C.C. Blue)	Sapphire Blue Y4241	Dark Blue Y4316	Flag Blue Y4990*
Sundown Buff Y4237	Grand Banks Beige Y4217	Bristol Beige Y4207	Hatteras Off-White Y4208	Sea Green Y4247
Fire Red Y4248*	Yellow Y4152	Hatteras Off-White (1990) Y4218		

### Interdeck

An excellent slip-resistant finish with a tough polyurethane resin that protects decks against everyday wear and tear. It contains a fine aggregate and will apply easily on all substrates. Interdeck has a low sheen finish to reduce sun glare from decks.



White YJB000	Gray YJF684	Cream YJC089	Sand Beige YJG009

### Bilgekote®

A fast drying, durable coating formulated for application in bilge areas. Bilgekote helps prevent substrate absorption of oil, gasoline or sludge (into wood and fiberglass surfaces). Want an easy-to-clean finish? Try Bilgekote today!



Gray YMA100	White YMA102



# Interlux® Antifouling Range

## Micron Technology Polishing Antifouling

- Micron is the original controlled-polishing antifouling, offering outstanding performance longevity with an extensive track record
- Longest lasting, multi-season protection with the ability to haul and relaunch without repainting
- Becomes smoother with use, reducing drag and maximizing fuel savings.

### Micron® 99

Ultimate Self-polishing antifouling designed for large yachts

- Multi-season antifouling with advanced Biolux® SPC Technology
- Controlled polishing for sustained protection in all waters
- For use on larger hulls (82+ feet) - professionally licensed application



Not for use in California

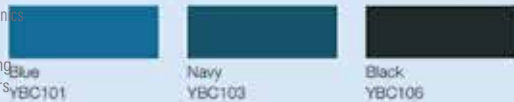

### Micron® CSC

Proven and trusted multi-season antifouling for all fouling threats

- Proven and trusted multi-season performance
- Suitable for power and sail, in all waters
- Minimizes paint build-up and sanding
- Not for use on aluminum
- Also available in High Solids VOC compliant formulation



### Micron® 66

Advanced self-polishing antifouling for multi-season performance

- Premium antifouling performance in the harshest fouling conditions - Use in salt water only
- Controlled polishing even while stationary
- Helps minimize sanding, drag and fuel consumption

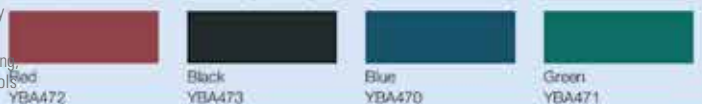

### Micron® WA

Micron Technology in a water-based formula

- Water Activated Matrix™ Technology delivers powerful protection with crisp, vibrant colors
- Outstanding protection in all waters
- Easy to apply, fast drying and easy clean up



Not for use in California

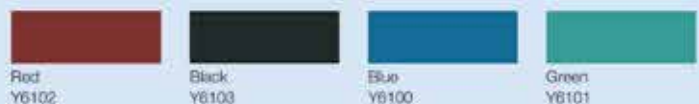

### Micron® Extra

Exceptional antifouling performance in all conditions

- Exceptional multi-seasonal polishing antifouling protection for all waters
- Biolux boosts performance by controlling slime
- Haul and relaunch without repainting with no paint buildup



### VC®17m Extra

High-performance, Low-friction antifouling for a smooth finish and dual protection for power and sail boats

- Dual protection with Biolux® Technology for protection against all fouling types
- Thin film with a fluoro-microadditive creates smooth, low-friction surface
- Provides a hard, smooth racing finish
- Quick-drying for a fast relaunch



Not for use in California



### NEW Micron Navigator™

Environmentally conscious multi-seasonal antifouling

- Water-based copper free available in bright colors
- Fast drying and lower temperature application - schedule flexibility
- Suitable for use on all boats types and substrates (includ. aluminum), in all waters



NEW!



### Micron® CF

Multi-season copper free antifouling for all substrates in all waters

- Multi-season, copper free antifouling
- Combats slime, shells and other fouling threats
- Suitable for use on all boats and substrates



## Pacifica® Plus

Ablative antifouling in a copper free formula, suitable for all boats and waters

- Ablative copper free season to season antifouling
- Biolux® Technology and E-conea™ for proven protection
- Fast-drying, low VOC

E-conea™ is a trademark of Johnson & Johnson.



## Ultra with Biolux®

Premium hard antifouling protection for high fouling areas

- Premium hard antifouling for long-lasting protection
- Biolux® Technology to help block slime
- Fast-drying, low VOC



## ACT

Well performing, low-maintenance season to season ablative antifouling

- Season to season antifouling performance
- Eliminates build-up and sanding
- Overcoats existing antifouling



Not for use in California



## Fiberglass Bottomkote® Aqua

Versatility, value and protection in a water-based antifouling

- Multi-Seasonal high performance antifouling performance
- Smooth, colorfast, and durable finish
- Thin film finish delivers minimal paint build-up



Not for use in California



For use on larger vessels (82+ feet) - professionally licensed application only.

## Aqua-One Performance Ablative

Convenient water-based antifouling for outstanding protection

- Outstanding water-based antifouling
- Easy application and clean-up
- Minimizes sanding requirements



Not for use in California

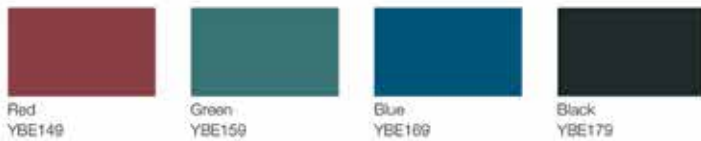

## Trilux® 33

Bright antifouling for all boats including aluminum

- Available in three bright colors, including white
- Biolux® Technology to help block slime
- Formulated for use on all boat types and substrates including aluminum
- available in aerosol formulation for use on drives and underwater metals



\* available in aerosol

## Fiberglass Bottomkote® NT

Quick to apply, easy to maintain, long-lasting antifouling

- Seasonal performance at a good value
- Dual resin technology minimizes build-up and sanding
- Paint and launch on the same day



## Non-antifouling InterZinc®

Underwater metal protection

- Metallic underwater corrosive protection
- Convenient, easy to use aerosol
- Superior adhesion for underwater metals





## InterProtect® Primers with Micro-Plates®

InterProtect primers with Micro-Plates can be used above and below waterline and on all substrates. Micro-Plate® Technology creates an overlapping barrier to help stop water migration through the coating reducing water migration through the epoxy to the hull surface which could lead to blistering.



### InterProtect® 2000E

- Fast drying, easy application
- Use as part of a no sand system
- The industry standard for more than 20 years

### InterProtect® HS

- High solids two-part epoxy
- High solids for fewer coats to achieve film build
- Protect metals from rust and oxidation
- Reduced solvent emissions

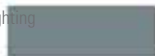

Y2000E

White Y2002E

Gray YPA423KIT

## Interlux® Wood Solutions

### Cetol® Marine

Cetol Marine with Next Wave™ UV-absorbing technology is a durable translucent protective wood finish for use above the waterline on interior and exterior woods. Next Wave technology is a unique UV package of advanced Ultra Violet absorbers that provide greater protection, durability and longevity. Cetol Marine has excellent weathering properties and allows for the natural expansion and contraction of wood which prevents Cetol Marine from cracking. Cetol Marine is also micro-porous, allowing moisture to escape from the wood which will prevent blistering and flaking of the finish. Cetol Marine is an easy to apply, low maintenance alternative to wood oils and other wood treatments.

• **Cetol Marine** produces an attractive dark amber appearance on wood.

• **Cetol Marine Light** produces a lighter amber appearance on wood.

• **Cetol Marine Natural Teak** has a rich golden color on wood.

• **Cetol Marine Gloss** provides a high-gloss, hard-wearing, UV protection and is developed as a topcoat for Cetol Marine, Cetol Marine Light and Cetol Marine Natural Teak.



Cetol Marine NA300

Cetol Marine Light NA290

Cetol Marine Natural Teak NA316

Cetol Marine Gloss NA315

International Paint LLC, 6001 Antoine Dr. Houston, TX USA 77091 Tel: (713) 682-1711 Technical Support Tel: 1-800-468-7589

Fax: (713) 684-1301 Email: InterluxTechnicalService@akzonobel.com

interlux.com

The information given in this document is not intended to be exhaustive. Any person using this product without first making further enquiries as to the suitability of the product for the intended purpose does so at their own risk and we can accept no responsibility for the performance of the product or for any loss or damage (other than death or personal injury resulting from negligence) arising out of such use. The information contained in this document is liable to modification from time to time in the light of experience and our policy of continuous development.

All trademarks mentioned in this publication are owned by, or licensed to, the AkzoNobel group of companies. © AkzoNobel 2020. Econex™ is a trademark of Johnson & Johnson. SKJ Catalog/USA 2020

93551919

## Perfection® Plus

A high performance, two-part clear polyurethane, Perfection Plus delivers the ultimate in performance longevity resistance. The chemical cure urethane formulation combines with a best-in-class UV and HALS package to offer outstanding chemical and abrasion resistance and superb gloss and gloss retention that lasts four times longer than conventional one-part varnishes.



## Schooner® Gold

This product offers a higher film build per coat that allows both professional applicator and boat owners to achieve great results faster and in fewer coats. This 'thicker' varnish will require thinning, in most conditions, to achieve optimum flow. Schooner Gold has shown to out-perform other leading brands and will offer superb longevity and durability.



## Schooner® 96

Combines the very best of classic varnish craftsmanship with the newest technology. Schooner Varnish contains ultra-violet filters to screen the sun's damaging rays for remarkable durability, excellent water resistance and silky application. Superior self-leveling property and a bright, clear, high-gloss finish with the traditional golden color.



## Compass® Clear

Compass Clear is a highly durable one-part polyurethane gloss varnish that contains a unique combination of ultra-violet additives, HALS, surface stabilizers and antioxidants to ensure long-term gloss and clarity. Polyurethane resin adds incredible abrasion, chemical and water resistance. Superior leveling properties along with silky application allows you to achieve a professional, long lasting finish. Compass Clear is suitable for all internal and external woods, and can be applied directly to oily timber, such as teak.



## Goldspar® Satin 60

A modified polyurethane, low luster varnish designed for application to interior wood surfaces. It produces a warm, rich satin sheen finish that resists scratches and stains and applies easily enough to yield truly professional results by either brush or spray. Goldspar Satin Varnish 60 is ideal anywhere a low luster finish is desired, such as cabin soles, cabinets, counters and tables.





**INTERLUX ABLATIVE ANTIFOULING PAINTS**

**Interlux Micron® 66® Antifouling Paint with Biolux SPC**



- Micron 66 combines Biolux Technology for increased antifouling performance with a true Self Polishing Copolymer that gradually polishes over time, even while stationary, to a smooth finish.
- This ensures maximum continuous protection over a long product life, helping to minimize drag and fuel consumption.
- **Suitable water types:** Sea water and brackish water.
- **Thinner:** Special Thinner 216 or Brush-Ease 433.



Order No.	Mfg. No.	Color	Size	List Price	
406035	(YBA470/03)	Blue	3 Gallon	<b>\$1,083.99</b>	E0-9921800
406036	(YBA470/01)	Blue	Gallon	<b>\$380.29</b>	E0-2258200
406042	(YBA471/01)	Green	Gallon	<b>\$380.29</b>	E0-2258200
406048	(YBA472/01)	Red	Gallon	<b>\$380.29</b>	E0-2258200
406049	(YBA473/03)	Black	3 Gallon	<b>\$1,083.99</b>	E0-9921800
406050	(YBA473/01)	Black	Gallon	<b>\$380.29</b>	E0-2258200

**Interlux Micron® Extra Multi-Season Antifouling Paint with Biolux**



- Micron Extra delivers excellent, long lasting antifouling protection against all types of fouling in all waters, by incorporating Biolux Technology, to control slime and algae.
- Its controlled polishing helps to maximize fuel efficiency while minimizing drag and prevent paint build-up, allowing the boat to be hauled and relaunched without re-applying.
- **Suitable water types:** Sea water, fresh water and brackish water.
- **Thinner:** Special Thinner 216 or Brush-Ease 433.

Order No.	Mfg. No.	Color	Size	List Price	
406010	(Y5690/01)	Blue	Gallon	<b>\$303.09</b>	E0-2372200
406018	(Y5693/01)	Black	Gallon	<b>\$303.09</b>	E0-2372200

**Interlux Micron® CSC Multi-Season Antifouling Paint**

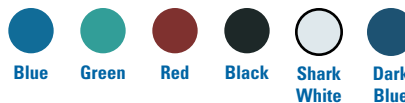

Order No.	Mfg. No.	Color	Size	List Price	
405904	(Y5580/03)	Blue	3 Gallon	<b>\$810.99</b>	E0-4280600
405907	(Y5580/01)	Blue	Gallon	<b>\$275.89</b>	E0-2960200
405921	(Y5581/01)	Green	Gallon	<b>\$275.89</b>	E0-2960200
405945	(Y5582/01)	Red	Gallon	<b>\$275.89</b>	E0-2960200
405966	(Y5583/03)	Black	3 Gallon	<b>\$810.99</b>	E0-4280600
405969	(Y5583/01)	Black	Gallon	<b>\$275.89</b>	E0-2960200
405983	(Y5584/01)	Shark White	Gallon	<b>\$275.89</b>	E0-2960200
405998	(Y5586/01)	Dark Blue	Gallon	<b>\$275.89</b>	E0-2960200

- Micron CSC provides long-lasting multi-season protection against all kinds of fouling threats, in all conditions.
- The controlled polishing also reduces the build-up of old coatings and minimizes sanding.
- The most trusted and dependable antifouling among boat owners, applicators and builders.
- **Suitable water types:** Sea water, fresh water and brackish water.
- **Thinner:** Special Thinner 216 or Brush-Ease 433.

**INTERLUX ABLATIVE WATER BASED ANTIFOULING PAINTS**

**Interlux Aqua-One™ Water-Based Ablative Antifouling Paint**



- Aqua-One combines outstanding antifouling performance in a convenient water-based ablative coating.
- The fast-dry formula makes application and clean-up easy, while the coating wears away during use, ensuring consistent performance and reducing the build-up of paint.
- **Suitable water types:** Sea water, fresh water and brackish water.
- **Thinner:** Water.

Order No.	Mfg. No.	Color	Size	List Price	
404436	(YBE169/1)	Blue	Gallon	<b>\$120.19</b>	E0-4109000
404474	(YBE159/1)	Green	Gallon	<b>\$120.19</b>	E0-4109000
404450	(YBE149/1)	Red	Gallon	<b>\$120.19</b>	E0-4109000
404400	(YBE179/1)	Black	Gallon	<b>\$120.19</b>	E0-4109000

**Interlux Fiberglass Bottomkote® Aqua Multi-Season Antifouling Paint**



- Fiberglass Bottomkote Aqua provides durable and colorfast antifouling which protects against all fouling threats.
- The water-based formula results in low odor and easy clean-up, combined with a low film thickness for a smooth racing finish. Ideal for use on new boats, trailered, and on inflatables.
- **Suitable water types:** Sea water, fresh water and brackish water.
- **Thinner:** Water.

Order No.	Mfg. No.	Color	Size	List Price	
432500	(YBA569/GL)	Blue	Gallon	<b>\$149.49</b>	E0-2121100
432524	(YBA579/GL)	Black	Gallon	<b>\$149.49</b>	E0-2121100



**SPECIAL HANDLING MAY APPLY**



- Electronics
- Trolling Motors
- Instruments
- Electrical
- Lighting
- Anchor & Dock
- Safety
- Steering, Controls
- Pumps
- Fuel System
- Seating & Pedestals
- Trailering
- Tops & Covers
- Perform.
- Propellers
- Engine & Care
- Cleaning & Care
- Paint & Paint Acc.**
- Fun & Flotation
- Topside Acc.
- Cockpit & Deck
- Hardware, Fasteners
- Camouflage
- Misc.
- Comm.

INTERLUX HARD ANTIFOULING PAINTS

Interlux Ultra™ Antifouling Paint with Biolux



- Ultra with Biolux Technology is formulated for high fouling areas & provides excellent long-term antifouling protection.
- The fast dry and low VOC formula of Ultra allows your boat to be painted and launched in the same day.
- The addition of Biolux Technology reduces slime and increases antifouling performance for a hard durable finish with excellent color stability.
- **Suitable water types:** Sea water, fresh water and brackish water.
- **Thinner:** Brush-Ease 433.

Order No.	Mfg. No.	Color	Size	List Price	
405380	(Y3449F/1)	Red	Gallon	\$204.29	E0-2235100
405411	(Y3559F/1)	Green	Gallon	\$204.29	E0-2235100
405442	(Y3669F/1)	Blue	Gallon	\$204.29	E0-2235100
405474	(Y3779F/1)	Black	Gallon	\$204.29	E0-2235100

Interlux VC® Offshore Regatta Baltoplate Racing Finish Antifouling Paint



- VC Offshore Baltoplate is a specialized hard antifouling for the dedicated racing or high performance boat, combining antifouling protection with the smoothness and low friction of a racing finish.
- For use on fiberglass, wood and primed metals (except aluminum), with proven performance on winning boats.
- **Suitable water types:** Sea water, fresh water and brackish water.
- **Thinner:** Special Thinner 216.

Order No.	Mfg. No.	Color	Size	List Price	
404804	(R3950/01)	Gray Metallic	Gallon	\$361.69	E0-7217200

Interlux Fiberglass Bottomkote® NT Antifouling Paint



- Fiberglass Bottomkote NT (New Technology) is formulated with unique Dual Resin Technology, providing the benefits of both hard and ablative antifouling.
- Combines durability, preventing premature wear-through, with slow polishing, ensuring consistent antifouling performance and a smooth finish.
- **Suitable water types:** Sea water, fresh water and brackish water.
- **Thinner:** Special Thinner 216 or Brush-Ease 433.

Order No.	Mfg. No.	Color	Size	List Price	
405654	(YBB349/01)	Red	Gallon	\$112.99	E0-4748000
405678	(YBB359/01)	Green	Gallon	\$112.99	E0-4748000
405620	(YBB369/01)	Blue	Gallon	\$112.99	E0-4748000
405591	(YBB369/QT)	Blue	Quart	\$40.69	E0-2503000
405629	(YBB379/01)	Black	Gallon	\$112.99	E0-4748000
405630	(YBB379/QT)	Black	Quart	\$40.69	E0-2503000

Interlux ACT Season - to - Season Antifouling Paint



- ACT provides great season to season antifouling performance.
- Ablative technology enables the coating to wear away during use, eliminating paint build-up and removing the need for sanding.
- Trusted by boaters and boatyards, ACT protects against moderate to heavy fouling in all water conditions.
- **Suitable water types:** Sea water, fresh water and brackish water.
- **Thinner:** Special Thinner 216 or Brush-Ease 433.

Order No.	Mfg. No.	Color	Size	List Price	
405565	(Y6690U/01)	Blue	Gallon	\$157.09	E0-2871100
405569	(Y7790U/01)	Black	Gallon	\$157.09	E0-2871100

Electronics

Trolling Motors

Instruments

Electrical

Lighting

Anchor & Dock

Safety

Steering, Controls

Pumps

Fuel System

Seating & Pedestals

Trailing

Tops & Covers

Perform.

Propellers

Engine & Care

Cleaning & Care

Paint & Paint Acc.

Fun & Flotation

Topside Acc.

Cockpit & Deck

Hardware, Fasteners

Camouflage

Misc.

Comm.

SPECIAL HANDLING MAY APPLY



**INTERLUX ALUMINUM ANTIFOULING PAINTS**

**Interlux Trilux® 33 Antifouling Paint with Biolux**



- Trilux 33 in combination with Biolux Slime Blocking Technology provides antifouling protection that is slow polishing and available in three bright colors, including white.
- Specifically formulated for use on aluminum boats, outdrives and outboards, and can also be applied to fiberglass, wood and other metals.
- **Suitable water types:** Sea water, fresh water and brackish water.
- **Thinner:** Special Thinner 216.

Order No.	Mfg. No.	Color	Size	List Price	
406252	(YBA060/01)	Blue	Gallon	\$283.59	E0-9621200
406290	(YBA063/01)	Black	Gallon	\$283.59	E0-9621200
406303	(YBA063/QT)	Black	Quart	\$83.39	E0-4526000
406319	(YBA063/PT)	Black	Pint	\$49.29	E0-7963000
406327	(YBA068/01)	White	Gallon	\$283.59	E0-9621200
406339	(YBA068/QT)	White	Quart	\$83.39	E0-4526000

**Interlux Pacifica® Plus Antifouling Paint with Biolux**



- Pacifica Plus is a copper free ablative antifouling with dual antifouling properties: Econeal for the control of barnacles and shell fouling, and Biolux Slime Blocking Technology.
- It is a fast-drying, low VOC, high solid ablative antifouling which minimizes paint build-up. Suitable for all boats including sail, power and ideal for aluminum pontoon boats.
- **Suitable water types:** Sea water, fresh water and brackish water.
- **Thinner:** Special Thinner 216.

Order No.	Mfg. No.	Color	Size	List Price	
404335	(YBB260/1)	Blue	Gallon	\$236.09	E0-7077100
404347	(YBB262/1)	Red	Gallon	\$236.09	E0-7077100
404359	(YBB263/1)	Black	Gallon	\$236.09	E0-7077100

**Interlux Trilux® 33® Aerosol Antifouling with Biolux**



- Trilux 33 Aerosol provides the same benefits as Trilux 33 in a convenient aerosol formula, utilizing Biolux Slime Blocking Technology.
- Specially formulated in Black, Grey and White for use on aluminum outdrives and other underwater metals.
- **Suitable water types:** Sea water, fresh water and brackish water.

Order No.	Mfg. No.	Color	Size	List Price	
405863	(YBA063A16)	Black	12 oz.	\$33.79	E0-4352000
405864	(YBA068A16)	White	12 oz.	\$33.79	E0-4352000
405870	(YBA064A16)	Gray	12 oz.	\$33.79	E0-4352000

**INTERLUX SAILBOAT ANTIFOULING PAINTS**

**Interlux VC® 17m Extra Antifouling Paint with Biolux**



- VC 17m Extra is a high-performance, friction-reducing antifouling that combines traditional antifouling protection with Biolux Slime Blocking Technology for complete protection in fresh water or low-fouling salt water, against zebra mussels and other fouling organisms.
- VC 17m Extra is formulated to be up to eight times thinner than traditional paint and with a fluoro-micro-additive that produces a smooth, low-drag surface, making it great for racing and cruising boats.
- **Suitable water types:** Sea water, fresh water and brackish water.
- **Thinner:** Special Thinner 216.

Order No.	Mfg. No.	Color	Size	List Price	
404169	(YBA406KIT/QT)	Blue	Quart	\$66.59	E0-4994000
404157	(YBA405KIT/QT)	Black (Original)	Quart	\$66.59	E0-4994000
404171	(YBA407KIT/QT)	Red	Quart	\$66.59	E0-4994000



**SPECIAL HANDLING MAY APPLY**



- Electronics
- Trolling Motors
- Instruments
- Electrical
- Lighting
- Anchor & Dock
- Safety
- Steering, Controls
- Pumps
- Fuel System
- Seating & Pedestals
- Trailer
- Tops & Covers
- Perform.
- Propellers
- Engine & Care
- Cleaning & Care
- Paint & Paint Acc.**
- Fun & Flotation
- Topside Acc.
- Cockpit & Deck
- Hardware, Fasteners
- Camouflage
- Misc.
- Comm.



INTERLUX TOPCOAT FINISHES

Interlux Brightside® Polyurethane Topside Finish



Yellow



Seattle Gray



Bristol Beige



Hatteras Off-White



Hatteras Off-White (1990)



Sapphire Blue



Sea Green



Fire Red



Steel Gray



Ocean Blue



Black



Blue-Glo White



Dark Blue



Light Blue



Medium Blue



White



Matterhorn White



Off-White

- A hard, high-gloss topside finish, Brightside Polyurethane creates that sprayed-on look when applied by brush in thin coats.
- It can be used anywhere above the true waterline, it's easy to clean, resists staining and has great abrasion resistance.
- **Suitable for above the waterline:** Hull, deck (non-skid additive), exterior cabin/trims, interior cabin/trims.
- **Thinner:** Brush - Brushing Thinner 333; Spray - Special Thinner 216.

Order No.	Mfg. No.	Color	Size	List Price	
407040	(Y4152/QT)	Yellow	Quart	\$40.99	E0-4703000
407052	(Y4205/QT)	Seattle Gray	Quart	\$40.99	E0-4703000
407088	(Y4207/QT)	Bristol Beige	Quart	\$40.99	E0-4703000
407103	(Y4208/QT)	Hatteras Off-White	Quart	\$40.99	E0-4703000
407140	(Y4218/QT)	Hatteras Off-White (1990)	Quart	\$40.99	E0-4703000
407280	(Y4241/QT)	Sapphire Blue	Quart	\$40.99	E0-4703000
407329	(Y4247/QT)	Sea Green	Quart	\$40.99	E0-4703000
407343	(Y4248/QT)	Fire Red	Quart	\$40.99	E0-4703000
407367	(Y4250/QT)	Steel Gray	Quart	\$40.99	E0-4703000
407406	(Y4253/QT)	Ocean Blue	Quart	\$40.99	E0-4703000
407432	(Y4258/QT)	Black	Quart	\$40.99	E0-4703000
407456	(Y4259/01)	Blue-Glo White	Gallon	\$116.79	E0-9578000
407468	(Y4259/QT)	Blue-Glo White	Quart	\$37.49	E0-2182000
407583	(Y4316/QT)	Dark Blue	Quart	\$40.99	E0-4703000
407709	(Y4351/QT)	Light Blue	Quart	\$40.99	E0-4703000
407711	(Y4353/QT)	Medium Blue	Quart	\$40.99	E0-4703000
407723	(Y4359/01)	White	Gallon	\$116.79	E0-9578000
407735	(Y4359/QT)	White	Quart	\$37.49	E0-2182000
407761	(Y4360/QT)	Matterhorn White	Quart	\$37.49	E0-2182000
407800	(Y4381/QT)	Off-White	Quart	\$37.49	E0-2182000

Interlux Interdeck Topside Finish - Non-Skid Finish



- A tough, slip resistant deck paint that protects the surface from every day wear and tear.
- It's easy to apply, comes in a range of colors and its low sheen finish helps prevent sunlight from reflecting off decks.
- **Suitable for above the waterline:** Deck - non-skid.
- **Thinner:** Special Thinner 216.

Order No.	Mfg. No.	Color	Size	List Price	
409753	(YJB000/QT)	White	Quart	\$36.89	E0-7672000
409789	(YJF684/QT)	Gray	Quart	\$36.89	E0-7672000

Interlux Premium Yacht Enamel™ Topside Finish



- With its superior hiding abilities, Premium Yacht Enamel is a very high quality topside finish.
- It's fast drying, easy to use and has excellent adhesion to properly prepared surfaces.
- You can use it above the true waterline for hull sides, decks, boot tops and fashion stripes.
- **Suitable for above the waterline:** Hull, deck (non-skid additive), exterior cabin/trims, interior cabin/trims.
- **Thinner:** Brush - Brushing Thinner 333; Spray - Special Thinner 216.

Order No.	Mfg. No.	Color	Size	List Price	
406505	(Y1/01)	White	Gallon	\$81.29	E0-7906000

Interlux Perfection® Topside Finish

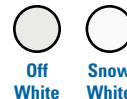

- Create a pro-like finish with this long-lasting, high-gloss topside paint.
- With UV filters, superb color retention and great chemical and abrasion resistance, it has everything you need.
- 2-part polyurethane.
- **Suitable for above the waterline:** Hull, deck (non-skid additive), exterior cabin/trims, interior cabin/trims.
- **Thinner:** YTA920, Brushing Reducer 2333N, Thinners Reducing Solvent Spray 2316N

Order No.	Mfg. No.	Color	Size	List Price	
408042	(YHA192KIT/QT)	Off White	Quart	\$77.69	E0-7285000
408080	(YHB000KIT/HG)	Snow White	Half Gallon	\$146.99	E0-4201100
408092	(YHB000KIT/QT)	Snow White	Quart	\$77.69	E0-7285000

Interlux Intergrip Noskid Compound



- A synthetic, granular material you can use on topside finishes before application, or sprinkled onto wet paint to add a more slip-resistant finish.
- The more you add, the more grip you get.
- **Suitable for above the waterline:** Deck - non-skid additive.

Order No.	Mfg. No.	Size	List Price	
409790	(Y2398C/QT)	Quart	\$33.69	E0-7252000

SPECIAL HANDLING MAY APPLY



Freshwater Exclusive



Saltwater Exclusive

Paint 1107

Paint &amp; Paint Acc.

## INTERLUX TOPCOAT FINISHES

## Interlux Bilgekote® Topside Finish



Order No.	Mfg. No.	Color	Size	List Price	
411325	(YMA102/01)	White	Gallon	\$77.09	E0-2875000
411326	(YMA102/QT)	White	Quart	\$26.79	E0-9002000
411327	(YMA100/01)	Gray	Gallon	\$77.09	E0-2875000
411328	(YMA100/QT)	Gray	Quart	\$26.79	E0-9002000

- Bilgekote is a fast drying, durable coating formulated for application to bilge areas.
- Bilgekote helps prevent absorption of oil, gasoline or sludge into wood and fiberglass.
- **Suitable for above the waterline:** Bilge/lockers.
- **Thinner:** Brush - Brushing Thinner 333; Spray - Special Thinner 216.

## INTERLUX UNDERCOATS (ABOVE THE WATERLINE)

## Interlux Epoxy Primekote™ Multi-Purpose Primer



- Suitable for use under all Interlux topside finishes, Epoxy Primekote is a multi-purpose two-part epoxy primer.
- It can be used to resurface cracked and crazed gelcoat, and over clear epoxies to eliminate the effects of amine blush.

Order No.	Mfg. No.	Size	List Price	
409108	(Y404KIT/01)	Gallon Kit	\$116.19	E0-4178000
409118	(Y404KIT/QT)	Quart Kit	\$39.99	E0-9992000

## Interlux Pre-Kote® Primer



- VOC compliant, Pre-Kote is an excellent undercoat for use with Brightside polyurethane, yacht enamels or any one-part topside finish.
- Formulated with Microspheres, it gives superior build and hide, whilst also improving flow and sandability.

Order No.	Mfg. No.	Color	Size	List Price	
408915	(Y4279/01)	White	Gallon	\$93.09	E0-2896000
408927	(Y4279/QT)	White	Quart	\$29.39	E0-4022000
408941	(Y4280/QT)	Gray	Quart	\$29.39	E0-4022000

## INTERLUX FILLERS AND EPOXY (ABOVE THE WATERLINE)

## Interlux Seam Compound White



- A durable, tight sealing compound perfect for filling hull seams of wooden boats above the waterline.
- Once applied, it remains pliable to allow for expansions and contractions of planks.
- It's also highly adhesive when applied over surfaces that have been primed properly.

Order No.	Mfg. No.	Color	Size	List Price	
410579	(Y31/QT)	White	Quart	\$39.99	E0-9992000

## INTERLUX FILLERS AND EPOXY (BELOW THE WATERLINE)

## Interlux Seam Compound Brown



- Easily applied by putty knife, Seam Compound Brown has been specifically designed for filling seams of wood boat bottoms and keel joints that flex.
- It remains durable and flexible even after it's been immersed to absorb expansion and contraction of planks.

Order No.	Mfg. No.	Color	Size	List Price	
410542	(Y30/QT)	Brown	Quart	\$37.89	E0-2482000

## INTERLUX FILLERS AND EPOXY (ABOVE AND BELOW THE WATERLINE)

## Interlux Watertite Epoxy Filler



- Watertite is a quick drying epoxy filler suitable for use on GRP, Metals and rigid Wood constructions.
- The formulation does not shrink and is extremely water resistant, making it suitable for osmosis damage repairs.
- Fills up to 3/4" without sagging.
- High-strength and adhesion properties, very fast drying and super smooth.
- Simple 1:1 mixing ratio for easy measurement of components.

Order No.	Mfg. No.	Size	List Price	
404309	(YAV135KIT500)	500 ml	\$35.69	E0-7762000
404323	(YAV135KIT/L)	Liter	\$59.39	E0-4544000



SPECIAL HANDLING MAY APPLY



www.repuestoselnavegante.com El Navegante

- Electronics
- Trolling Motors
- Instruments
- Electrical
- Lighting
- Anchor & Dock
- Safety
- Steering, Controls
- Pumps
- Fuel System
- Seating & Pedestals
- Trailer
- Tops & Covers
- Perform.
- Propellers
- Engine & Care
- Cleaning & Care
- Paint & Paint Acc.
- Fun & Flotation
- Topside Acc.
- Cockpit & Deck
- Hardware, Fasteners
- Camouflage
- Misc.
- Comm.

INTERLUX PRIMERS

Interlux InterProtect® 2000E with Micro-Plates®



- This remarkable two-part epoxy coating protects fiberglass hulls from water absorption.
- It's formulated with Microplates that creates an overlapping water barrier.
- It's also great for repairing gelcoat that has been damaged by osmotic blistering.
- Excellent adhesion to fiberglass, composite, metal and wood.
- Suitable for use above and below the waterline as a universal primer for all surfaces.
- Long overcoating times add versatility and flexibility.

Order No.	Mfg. No.	Color	Size	List Price	
409163	(Y2000EKIT/01)	Gray	Gallon	\$108.49	EO-7318000
409157	(Y2000EKIT/QT)	Gray	Quart	\$36.39	EO-9272000
409165	(Y2002EKIT/01)	White	Gallon	\$108.49	EO-7318000
409166	(Y2002EKIT/QT)	White	Quart	\$36.39	EO-9272000

3 GALLON SIZE - NEED TO ORDER CURING AGENT SEPARATELY

Order No.	Mfg. No.	Color	Size	List Price	
409150	(Y2000E/03)	Part A, Gray	3 Gallon	\$231.69	EO-7737100
409152	(Y2002E/03)	Part A, White	3 Gallon	\$231.69	EO-7737100
409154	(Y2001E/01)	Part B - Curing Agent	Gallon	\$76.99	EO-4775000

Interlux Primocon® Aerosol



- A non-bleeding, anti-corrosive primer, Primocon Aerosol provides an excellent barrier for underwater metal surfaces, reducing galvanic corrosion.
- You can use before applying Trilux 33 Aerosol or Trilux 33.

Order No.	Mfg. No.	Size	List Price	
409225	(YPA985n/16)	12 oz.	\$22.09	EO-7561000

Interlux InterProtect® HS with Micro-Plates®



- A versatile, high solids epoxy, InterProtect HS can be used above and below the waterline as a primer for all substrates.
- It's formulated with Microplates to create an overlapping water barrier and prevent blistering.
- It can also provide metal corrosion protection.
- It meets the most restrictive VOC regulations.

Order No.	Mfg. No.	Color	Size	List Price	
409190	(YPA423KIT/01)	Gray	Gallon Kit	\$125.49	EO-2149000

Interlux Primocon® Underwater Primer



- Suitable for all underwater metal surfaces, Primocon is a superb anti-corrosive primer that creates a barrier to reduce pitting.
- It's an excellent primer for antifouling paint over sanded fiberglass, and won't affect the color of antifouling paint itself.

Order No.	Mfg. No.	Color	Size	List Price	
409208	(YPA984/01)	Gray	Gallon	\$91.59	EO-9686000
409210	(YPA984/QT)	Gray	Quart	\$28.79	EO-9512000

Interlux Interprime™ Wood Sealer



- Inter-Prime Wood Sealer Clear is specially formulated to seal the grain and stop varnish from soaking into the wood.
- This allows future coats of varnish or paint to dry without high and low spots.
- It's particularly good for sealing plywood to resist cracking and checking.
- It's suitable for either interior or exterior use.

Order No.	Mfg. No.	Color	Size	List Price	
408852	(Y1026/QT)	Clear	Quart	\$23.49	EO-2671000

Interlux Fiberglass Surface Prep



- It's extremely important to remove contaminants from fiberglass for full adhesion of primers and/or antifouling paints.
- With its special low VOC formula, Fiberglass Surface Prep does this extremely effectively.
- It can also be used to remove amine blush from clear epoxy.
- And it can be used to prepare inflatable boats for antifouling

Order No.	Mfg. No.	Size	List Price	
409323	(YMA601V/QT)	Quart	\$19.79	EO-4841000

SPECIAL HANDLING MAY APPLY



- Electronics
- Trolling Motors
- Instruments
- Electrical
- Lighting
- Anchor & Dock
- Safety
- Steering, Controls
- Pumps
- Fuel System
- Seating & Pedestals
- Trailer
- Tops & Covers
- Perform.
- Propellers
- Engine & Care
- Cleaning & Care
- Paint & Paint Acc.
- Fun & Flotation
- Topside Acc.
- Cockpit & Deck
- Hardware, Fasteners
- Camouflage
- Misc.
- Comm.





## INTERLUX VARNISHES

## Interlux Perfection® Plus Varnish



- Perfection Plus really is the ultimate clear wood varnish.
- It offers outstanding chemical and abrasion resistance, UV protection and a superb gloss finish with great retention that lasts four times longer than normal one-part varnishes.
- Can be used in combination with Perfection Finish as a glaze coat to increase flow, levelling and durability.
- Suitable for oily woods like teak after adequate degreasing and substrate preparation.

Order No.	Mfg. No.	Color	Size	List Price
408408	(YVA950KIT/QT)	Clear	Quart	\$79.89 E0-2995000

## Interlux Goldspar® Satin Varnish



- Goldspar Satin produces a warm, rich satin sheen finish that's scratch and stain resistant.
- You can use it on all interior surfaces from cabin soles to cabinets - and as it's so simple to apply, you'll easily be able to create professional finish by brush or spray.

Order No.	Mfg. No.	Size	List Price
408547	(Y60/QT)	Quart	\$28.09 E0-7012000

## Interlux Schooner® Varnish



- Schooner Varnish creates a bright, clear, pristine high gloss finish with a traditional golden color.
- Added to this it offers remarkable durability, water resistance, UV protection and a nice silky application.
- Superior self-leveling properties makes it easy to get a professional finish.

Order No.	Mfg. No.	Size	List Price
408603	(Y96/QT)	Quart	\$32.09 E0-7042000

## Interlux Original® Varnish



- With good gloss and durability, Original is a traditional spar varnish that creates a stunning golden color.
- As it's so simple to apply you can create a professional with ease on interior and exterior woodwork such as cabin trim, handrails and coamings.

Order No.	Mfg. No.	Size	List Price
408561	(Y90/QT)	Quart	\$20.59 E0-4451000

## Interlux Schooner® Gold Varnish



- Schooner Gold is a premium varnish that has a higher film build per coat, so you can work faster and use fewer coats.
- It's our longest lasting one-part varnish and will require thinning in most conditions to achieve optimum flow.
- Plus, it contains advanced UV protection.
- Offers excellent self-leveling, superb longevity and durability.
- Suitable for all internal and external woods, including oily timbers such as teak.

Order No.	Mfg. No.	Size	List Price
408612	(YVA500/QT)	Quart	\$40.39 E0-9203000
408624	(YVA500/PT)	Pint	\$22.89 E0-7171000

## Interlux Cetol® Marine - Wood Treatment



## CETOL MARINE

- Next Wave UV-absorbing technology offers incredible UV protection.
- Microporous finish with UV protection that doesn't crack or flake.
- Creates an attractive dark amber appearance.

Order No.	Mfg. No. / Description	List Price
408888	(IVA300/QT) Quart	\$34.29 E0-2752000

## CETOL MARINE LIGHT

- Creates a light amber, high gloss, hard wearing topcoat finish.
- Next Wave UV-absorbing technology offers incredible UV protection.
- It can't be used on decks.

Order No.	Mfg. No. / Description	List Price
408876	(IVA290/QT) Quart	\$34.29 E0-2752000

## CETOL MARINE GLOSS

- Cetol Marine Gloss creates a superb high gloss hard wearing finish, that's really easy to clean and has excellent UV protection thanks to its Next Wave UV-absorbing technology.
- However, it can't be used on decks.

Order No.	Mfg. No. / Description	List Price
408890	(IVA315/QT) Quart	\$37.49 E0-2182000

## CETOL MARINE NATURAL TEAK

- Next Wave UV-absorbing technology offers incredible UV protection.
- Easy to apply and maintain it creates a traditional classic look that every boat owner loves.
- Specialty resins and advanced UV absorbers that provide greater protection, durability and longevity.

Order No.	Mfg. No. / Description	List Price
408903	(IVA316/QT) Quart	\$34.29 E0-2752000

Electronics

Trolling Motors

Instruments

Electrical

Lighting

Anchor &amp; Dock

Safety

Steering, Controls

Pumps

Fuel System

Seating &amp; Pedestals

Trailing

Tops &amp; Covers

Perform.

Propellers

Engine &amp; Care

Cleaning &amp; Care

Paint &amp; Paint Acc.

Fun &amp; Flotation

Topside Acc.

Cockpit &amp; Deck

Hardware, Fasteners

Camouflage

Misc.

Comm.

INTERLUX THINNERS

Interlux Fiberglass Solvent Wash



- An amazing at removing mold release agents, wax, oil and grease from hulls of bare fiberglass boats.
- It also removes wax and silicone contamination from painted hull surfaces that are being prepared for repainting.



Order No.	Mfg. No.	Size	List Price
409309	(Y202/O1)	Gallon	\$50.19 E0-4673000
409311	(Y202/QT)	Quart	\$17.49 E0-2131000

Interlux Brushing Liquid



- A slow drying solvent, Brushing Liquid 333 eases brushing and helps with the flow of specified paint coatings.
- It's also recommended for use in various topside systems to remove sanding residue from fiberglass and wood surfaces.

Order No.	Mfg. No.	Size	List Price
409462	(Y333/QT)	Quart	\$17.49 E0-2131000
409474	(Y333/PT)	Pint	\$12.29 E0-2290000

Interlux Special Thinner



- A fast evaporating solvent, Special Thinner 216 improves paint drying in cold climates and makes spray application easier.
- You can also use it to remove sanding residue from hull bottoms, wiping clean bare aluminum and for the general clean-up of paint equipment.



Order No.	Mfg. No.	Size	List Price
409373	(Y216/O1)	Gallon	\$35.29 E0-7462000
409397	(Y216/QT)	Quart	\$15.09 E0-2311000

Interlux Reducing Solvent - Spray



- For use in specific two-part polyurethane and epoxy products, Reducing Solvent 2316N is a very effective, fast evaporating solvent.
- Please make sure you read the product directions to ensure you use the correct amount.



Order No.	Mfg. No.	Size	List Price
409548	(Y2316N/O1)	Gallon	\$46.59 E0-4943000
409549	(Y2316N/QT)	Quart	\$16.39 E0-9221000

Interlux Reducing Solvent - Brush



- For use in specific two-part polyurethane and epoxy products, Reducing Solvent 2316N is a very effective, slow evaporating solvent.
- Please make sure you read the product directions to ensure you use the correct amount.

Order No.	Mfg. No.	Size	List Price
409587	(Y2333N/QT)	Quart	\$25.39 E0-4091000

Interlux Brush-Ease



- Formulated to ease brushing, rolling and to improve flow, Brush-Ease 433 is an excellent slow drying solvent.
- As it's not an all-purpose solvent, make sure you only use it in antifouling products where it states it's ok to do so.

Order No.	Mfg. No.	Size	List Price
409676	(Y433/QT)	Quart	\$15.69 E0-7711000

These are only general requirements. Thinner quality and type vary depending upon temperature and specific application.



Product	Brush Solvent	Spray Solvent
Perfection	2333N	2316N
Brightside, Yacht Enamel	333	216
Varnishes	333	216
Pre-Kote	333	216
VC 17m Extra	216	216
VC Offshore	216	216

Product	Brush Solvent	Spray Solvent
Bottom Paints (Conventional)	216	216
Micron 66, Micron Extra, Micron CSC, ACT	433	216
Trilux 33, Pacifica Plus	216	216
InterProtect 2000E	2333N	2316N
Epoxy Primekote	2333N	2316N
Primocon	433	216

SPECIAL HANDLING MAY APPLY

- Electronics
- Trolling Motors
- Instruments
- Electrical
- Lighting
- Anchor & Dock
- Safety
- Steering, Controls
- Pumps
- Fuel System
- Seating & Pedestals
- Trailing
- Tops & Covers
- Perform.
- Propellers
- Engine & Care
- Cleaning & Care
- Fun & Flotation
- Topside Acc.
- Cockpit & Deck
- Hardware, Fasteners
- Camouflage
- Misc.
- Comm.

**International Paint Intergard 822**



- A two pack epoxy filler.
- Zero VOC.
- For use as a filler for pitted steel prior to maintenance coating.
- Also, approved for use on anode shields.
- For use at Newbuilding, Maintenance and Repair or On Board Maintenance.
- Color: EAA200-Red.
- Part B (Curing Agent): EAA 201.
- Method of Application: Knife, trowel.

Order No.	Mfg. No. / Description	Size	List Price	
410819	(EAA201/94/A) Part B	Quart	\$44.89	E0-7633000
410833	(EAA200/94/A) Part A	Quart	\$44.89	E0-7633000

**International Paint Intergard 264**



- A two pack, self priming, surface tolerant epoxy with low semi-gloss finish.
- Exhibits excellent chemical and abrasion resistance.
- Low VOC.
- A universal anticorrosive for use on underwater hulls, above water and internal areas of marine vessels, barges and offshore structures.
- For use at Newbuilding, Maintenance and Repair or On Board Maintenance.
- Method of Application: Airless spray, roller, brush, conventional spray.
- For cleaning, use thinner 412065 (GTA220).

Order No.	Mfg. No.	Color	Size	List Price	
412094	(FPL274/5/A)	Red	5 Gallon	\$317.79	E0-4383200
412096	(FPJ034/5/A)	Light Gray	5 Gallon	\$317.79	E0-4383200
412097	(FPY999/5/A)	Black	5 Gallon	\$304.19	E0-4182200

**International Paint Intertuf® 262**



- A surface tolerant, two pack epoxy primer.
- As an epoxy anticorrosive coating for use from keel to rail.
- Suitable for sue with controlled cathodic protection.
- For use at Newbuilding, Maintenance and Repair or On Board Maintenance.
- For cleaning, use thinner 412065 (GTA220).

Order No.	Mfg. No. / Description	Size	List Price	
412083	(KHA302/1/A)	Light Gray	Gallon	\$77.29 E0-7975000
412084	(KHA302/5/A)	Light Gray	5 Gallon	\$226.59 E0-4996100
412091	(KHA304/5/A)	Black	5 Gallon	\$319.39 E0-4593200
412078	(KHA062)	Curing Agent - Part B	Gallon	\$66.79 E0-9005000

**International Paint Intertherm 891**



- A one pack Oleoresinous Aluminum Coating.
- As a light reflective finish for cargo holds, pipes, etc.
- It is suitable for use on surfaces that are likely to reach dry heat temperatures of up to 482° F. This may be extended up to 600° F if the dry film thickness is reduced to 0.6 mils.
- For use at Newbuilding, Maintenance and Repair or On Board Maintenance.
- Use thinner 412062 (GTA004).

Order No.	Mfg. No.	Size	List Price	
412099	(HTA002)	Gallon	\$78.19	E0-4685000

**International Paint Interlac® 665 Alkyd Finish**



- A one pack alkyd gloss finish.
- For use as an easily maintained cosmetic finish coat on areas above the waterline.
- For use at Newbuilding, Maintenance and Repair or On Board Maintenance.
- Method of Application: Airless spray, roller, brush, conventional spray.
- Use thinner 412062 (GTA004).

Order No.	Mfg. No.	Color	Size	List Price	
412014	(CLA074)	Blue White	Gallon	\$59.09	E0-2344000
412018	(CLB000)	White	Gallon	\$58.49	E0-7834000
412020	(CLB953)	Signal Blue	Gallon	\$66.39	E0-9794000
412022	(CLB134)	Safety Yellow	Gallon	\$81.29	E0-7906000
412026	(CLC287)	Signal Red	Gallon	\$83.69	E0-7726000
412030	(CLB295)	Ensign Red	Gallon	\$83.69	E0-7726000
412034	(CLC935)	Caribbean Blue	Gallon	\$69.39	E0-4025000
412036	(CLD260 PAINT)	International Orange	Gallon	\$87.39	E0-4556000
412038	(CLF684)	Surf Gray	Gallon	\$61.69	E0-7264000
412040	(CLG609)	Dark Green	Gallon	\$69.39	E0-4025000
412042	(CLK724)	Storm Gray	Gallon	\$63.59	E0-9674000
412044	(CL71048)	Haze Gray	Gallon	\$59.09	E0-2344000
412046	(CLL274)	Red Oxide	Gallon	\$64.49	E0-7384000
412047	(CL71009/1GL)	Safety Purple	Gallon	\$79.49	E0-2695000
412048	(CL71032/1)	Safety Blue	Gallon	\$64.29	E0-2284000
412050	(CLL549)	Signal Green	Gallon	\$65.39	E0-4094000
412051	(CLR764)	Admiral Gray	Gallon	\$62.59	E0-4964000
412052	(CLP462)	Alpine Green	Gallon	\$69.39	E0-4025000
412053	(CLT806)	Mid Graphite	Gallon	\$63.49	E0-2674000
412054	(CLY999)	Black	Gallon	\$41.99	E0-9413000

**International Paint Interlac 800**



- A one pack, high solids, low VOC, gloss silicone alkyd with excellent color and gloss retention.
- As an easily maintained cosmetic finish for above water areas.
- For use at Newbuilding, Maintenance and Repair or On Board Maintenance.
- Method of Application: Airless spray, roller, brush, conventional spray.
- Use thinner 412063 (GTA007).

Order No.	Mfg. No.	Color	Size	List Price	
412074	(800/Y999-1)	Black	Gallon	\$130.79	E0-9089000
412080	(800/87426)	Gunmetal Gray	Gallon	\$132.39	E0-9299000



**SPECIAL HANDLING MAY APPLY**



- Electronics
- Trolling Motors
- Instruments
- Electrical
- Lighting
- Anchor & Dock
- Safety
- Steering, Controls
- Pumps
- Fuel System
- Seating & Pedestals
- Trailing
- Tops & Covers
- Perform.
- Propellers
- Engine & Care
- Cleaning & Care
- Paint & Paint Acc.
- Fun & Flotation
- Topside Acc.
- Cockpit & Deck
- Hardware, Fasteners
- Camouflage
- Misc.
- Comm.



International Paint Interprime 198



- A quick drying, one pack primer.
- It is surface tolerant, compatible with most substrates and can be overcoated with a wide range of finishes.
- For the maintenance of above water areas.
- Approved for the carriage of grain when used as part of an approved scheme.
- For use at maintenance and repair or on board maintenance.
- Method of Application: Airless spray, roller, brush.
- Use thinner **412063** (GTA007).

Order No.	Mfg. No.	Color	Size	List Price	
<b>412057</b>	(CPA098)	Gray	Gallon	<b>\$72.59</b>	E0-4445000
<b>412058</b>	(CPA099)	Red	Gallon	<b>\$72.59</b>	E0-4445000

International Paint Progressive Barge



Order No.	Mfg. No.	Color	Size	List Price	
<b>412008</b>	(CL74840)	Brown	Gallon	<b>\$65.19</b>	E0-9884000
<b>412010</b>	(CL74913)	Yellow	Gallon	<b>\$67.39</b>	E0-4505000
<b>412012</b>	(CL75044)	Red	Gallon	<b>\$67.39</b>	E0-4505000
<b>412013</b>	(CL75044/5)	Red	5 Gallon	<b>\$324.19</b>	E0-4134200

International Paint 950 Biodegradable Cleaner



- A water base, biodegradable alkaline cleaner.
- To remove oil, grease and other contaminants prior to further surface preparation or for general cleaning purposes.
- For interior and exterior surfaces.

Order No.	Mfg. No.	Size	List Price	
<b>412061</b>	(GMA571/5)	5 Gallon	<b>\$185.89</b>	E0-2493100

International Paint Non Slip Aggregate



- A non slip aggregate for deck systems.

Order No.	Mfg. No.	Size	List Price	
<b>412060</b>	(GMA197 01)	Gallon	<b>\$27.49</b>	E0-2602000

International Paint Non-Skid Additive - Fine



Order No.	Mfg. No.	Size	List Price	
<b>412059</b>	(7754D)	Gallon	<b>\$60.89</b>	E0-7654000

International Paint Thinners



GTA004 THINNER

- A petroleum solvent used primarily as a thinner for conventional coatings.

Order No.	Mfg. No. / Description	List Price	
<b>412062</b>	(GTA004) Gallon	<b>\$37.19</b>	E0-9872000

GTA007 THINNER

- An aromatic hydrocarbon used in alkyd primers, chlorinated rubber coatings and some epoxies.

Order No.	Mfg. No. / Description	List Price	
<b>412063</b>	(GTA007) Gallon	<b>\$48.19</b>	E0-4163000

GTA220 THINNER

- An aromatic/glycol ether/ketone blend used in epoxies, vinyls and zincs.

Order No.	Mfg. No. / Description	List Price	
<b>412065</b>	(GTA220) Gallon	<b>\$37.99</b>	E0-9482000

GTA056 THINNER

- A thinner and equipment cleaner for use with certain Intershield and Interthane products in North America.

Order No.	Mfg. No. / Description	List Price	
<b>412064</b>	(GTA056/1) Gallon	<b>\$45.99</b>	E0-9443000

- Electronics
- Trolling Motors
- Instruments
- Electrical
- Lighting
- Anchor & Dock
- Safety
- Steering, Controls
- Pumps
- Fuel System
- Seating & Pedestals
- Trailer
- Tops & Covers
- Perform.
- Propellers
- Engine & Care
- Cleaning & Care
- Fun & Flotation
- Topside Acc.
- Cockpit & Deck
- Hardware, Fasteners
- Camouflage
- Misc.
- Comm.

**SPECIAL HANDLING MAY APPLY**



**AVAILABLE IN SELECTED WAREHOUSES**

**Epifanes Clear Varnish**



- This traditional marine varnish is based on tung oil, phenolic-modified alkyd resins and maximum U.V. absorbers.
- It has outstanding protection for all marine and household woods and can be applied to Interior and exterior woods above the waterline.
- It offers superior flow and durability.
- It has excellent flexibility and water resistance in all climate conditions.

Order No.	Mfg. No.	Size	List Price
023008	(CV.1000)	1,000 ML	\$54.59 G0-8563000
023010	(CV.500)	500 ML	\$29.49 G0-6791000

**Epifanes Wood Finish Gloss**



- It's based on phenolic-modified resins and tung oil with microscopic porosity properties.
- Specifically formulated for oily woods like teak and iroko, Wood Finish Gloss has an ultra high gloss finish.
- Its color is clear amber.
- Excellent flow, gloss and durability and offers great flexibility and water resistance in all weather conditions.

Order No.	Mfg. No.	Size	List Price
023040	(WFG.500)	500 ML	\$33.69 G0-7522000
023046	(WFG.1000)	1,000 ML	\$58.89 G0-6493000

**Epifanes Rapidcoat**



- Offers quick and easy wood protection without the hassle of sanding between coats.
- It's a one-component wood finish based on modified alkyd/urethane resin.
- Epifanes Rapidcoat can be used for renewing weathered areas prior to applying a varnish system or as a full system for those requiring a quick and easy semi-gloss finish with maximum durability, U.V. protection and longevity.
- Rapidcoat provides an enhancing coat that bonds extremely well to teak and other oily woods, preventing discoloration and emphasizing the natural grain of the wood.
- It has great water resistance and flexibility.

Order No.	Mfg. No.	Size	List Price
023072	(RC.750)	750 ML	\$50.39 G0-6733000

**Epifanes Easy-Flow**



- A multi-purpose additive or stand alone coating based on a selection of natural oils.
- Suitable for use in one-component conventional and half-synthetic varnishes, paints and primers to optimize impregnation/saturation and preservation of the surface.
- Flow enhancer under cold or hot working conditions.
- Stand alone product to prevent rust on steel (penetrates existing thin layers of rust through to the steel) and as impregnating oil on wood.

Order No.	Mfg. No.	Size	List Price
023015	(EF.500)	500 ML	\$27.99 G0-5781000

**Epifanes Rubbed Effect Varnish**



- A one-component interior varnish based on urethane alkyd resins, gives a rich clear amber satin finish.
- Can be applied directly to bare wood, any interior softwood or hardwood and is highly recommended for cabin sole, doors and trim.
- It's hard satin finish has good scratch and scuff resistance and is impervious to most onboard chemicals.

Order No.	Mfg. No.	Size	List Price
023018	(RE.1000)	1,000 ML	\$64.29 G0-7034000

**Epifanes Wood Finish Matte**



- It's a one-component varnish alternative based on urethane alkyd resins and tung oil and contains U.V. absorbers.
- Specifically formulated for oily woods like teak and iroko.
- It's finish is a rich matte with a clear amber color and has the appearance of being hand-rubbed.
- It offers superior flow and durability and excellent scratch resistance and exterior weather resistance.

Order No.	Mfg. No.	Size	List Price
023058	(WFM.500)	1,000 ML	\$39.49 G0-6462000

**Epifanes Rapidclear**



- Offers quick and easy wood protection without the hassle of sanding between coats.
- It's a one-component clear wood finish based on modified alkyd/urethane resin.
- Epifanes Rapidclear can be used for renewing weathered areas prior to applying a varnish system for those requiring a quick and easy semi-gloss finish with maximum durability, U.V. protection and longevity.
- Rapidclear provides an enhancing coat that bonds extremely well to teak and other oily woods, preventing discoloration and emphasizing the natural grain of the wood.
- It has great water resistance and flexibility.

Order No.	Mfg. No.	Size	List Price
023084	(RCC.750)	750 ML	\$50.39 G0-6733000

**Epifanes Thinners for Paint and Varnish**



**BRUSH THINNER FOR PAINT AND VARNISH**

- The double distillation of this thinner provides maximum purity.

Order No.	Mfg. No.	Size	List Price
023022	(TPVB.1000)	1,000 ML	\$19.29 G0-2921000

**SPRAY THINNER FOR PAINT AND VARNISH**

- Highly suited for degreasing wood and existing paint and varnish layers.

Order No.	Mfg. No.	Size	List Price
023060	(TPVS.1000)	1,000 ML	\$22.09 G0-0841000

- Electronics
- Trolling Motors
- Instruments
- Electrical
- Lighting
- Anchor & Dock
- Safety
- Steering, Controls
- Pumps
- Fuel System
- Seating & Pedestals
- Trailering
- Tops & Covers
- Perform.
- Propellers
- Engine & Care
- Cleaning & Care
- Paint & Paint Acc.
- Fun & Flotation
- Topside Acc.
- Cockpit & Deck
- Hardware, Fasteners
- Camouflage
- Misc.
- Comm.

Mascoat Sound Control - dB (Sound Damping Coating)



- Reduction of structure-borne noise and vibrations.
- Saves installation time compared to sound damping tiles.
- Reduce overall construction time-frame.
- Excellent vapor barrier.
- Keeps substrates viewable at all times.
- Protect personnel.
- Increase interior comfort.
- No risk of water entrapment.
- Lightweight compared to damping tiles.
- Meets IMO/SOLAS guidelines.
- Easily repairable if needed.

Order No.	Mfg. No.	Color	Size	List Price
496522	(2101FGDBWHT)	White	5 Gallon	\$477.99 B0-9103400

Mascoat Marine - DTM (Thermal Insulating Coating)



- Mascoat Marine-DTM insulating coating is a water-based, one-part coating comprised of air filled ceramic and silica beads held in suspension by an acrylic binder.
- It applies like paint and is maintenance-free, providing thermal insulating and anti-condensation capabilities for shipboard construction.
- Currently, Mascoat Marine-DTM insulating coating is in use on over 2000 marine vessels from Alaska to Antarctica.
- This coating can replaced most blanket and foam insulation products, resulting in substantial reduction of weight and keeping the vessel within the new stringent marine codes and classifications.
- The coating employs the best water-based coating technology and contains no harmful elements.
- Unlike other insulation methods, Mascoat Marine-DTM bonds directly to the substrate or primer, leaving no room for corrosion to take hold.
- Direct bonding gives the coating the ability to insulate your vessel without degradation of the substrate for many years to come.
- By using Mascoat Marine-DTM coating system, you can rest assured that your vessel is protected and that the interior accommodations will be comfortable.
- Users of Mascoat Marine-DTM insulation coating have found that the coating replaces most conventional insulation methods.
- While yielding the same insulation capabilities, installing costing drastically less.
- Many vessel owners have saved up to 50% on total installed costs over conventional insulation.
- Best of all, the coating is extremely lightweight.
- This allows easy application around difficult areas such as stiffeners and other tight areas without adding excess weight.

Order No.	Mfg. No.	Color	Size	List Price
496517	(1101FGDTMWH)	White	5 Gallon	\$477.99 B0-9103400

Tuff-Coat Marine Non-Skid Coating



- Ideal for commercial and recreational vessels or docks/ramps.
- Superior durability and flexibility.
- Non-abrasive, recycled rubber aggregate for traction and comfort in any weather.
- Comes in 1 gallon cans or 5 gallon pails.
- Made in the USA.

KEY FEATURES

- Water-based/no smell/water clean up.
- Rubber Aggregate/non-abrasive.
- Roll or Spray on application.
- 21 Standard Colors.
- Single Component/No Mixing.
- Chemical & UV Resistant.
- Flexible.
- Non-Flammable.
- No shipping restrictions.
- Extremely Durable.
- User Friendly.

ADHERES TO:

- Wood.
- Steel.
- Aluminum.
- Fiberglass.
- Gel Coat.
- Concrete.
- Painted Surfaces.

SPECIAL HANDLING MAY APPLY

- Electronics
- Trolling Motors
- Instruments
- Electrical
- Lighting
- Anchor & Dock
- Safety
- Steering, Controls
- Pumps
- Fuel System
- Seating & Pedestals
- Trailer
- Tops & Covers
- Perform.
- Propellers
- Engine & Care
- Cleaning & Care
- Paint & Paint Acc.
- Fun & Flotation
- Topside Acc.
- Cockpit & Deck
- Hardware, Fasteners
- Camouflage
- Misc.
- Comm.



# AWLGRIP® / AWLCRAFT® 2000 / AWLCRAFT® SE

BLUE **G** OR **H** CODE NUMBERS = AWLGRIP® / BLACK **F** CODE NUMBERS = AWLCRAFT® 2000 / RED **L** OR **E** CODE NUMBER - AWLCRAFT® SE



Soft Pink  
H7550 / F7356 / L7012



Hot Pink  
H7268 / F7286 / L7009



Bright Red Orange  
H7483 / F7414 / L7007



International Orange  
H7362 / F7233 / L7004



Vermillion  
H9202 / F9327 / L9005



Rochelle Red  
H7426 / F7321 / L7011



Treador  
H7161 / F7232 / L7008



Sunfast Red  
G7214 / F7242 / L7002



Vivid Red  
G7367 / F7200 / L7005



Claret  
G7305 / F7029 / L7003



Red Mahogany  
G7022 / F7252 / L7001



Cabernet Burgundy  
H7425 / F7320 / L7010



Catboat Tan  
H6462 / F6280 / L6012



Sahara Tan  
G6009 / F6017 / L6005



Horizons Teak  
H6443 / F6318 / L6011



Sable Brown  
G6001 / F6171 / L6001



Mocha  
G6324 / F6286 / L6007



Sarafsa Red  
G7466 / F7413 / L7006



Fighting Lady Yellow  
G9093 / F9120 / L9002



San Mateo Wheat  
G9001 / F9014 / L9001



Yellow  
H9256 / F9316 / L9006



Lemon Yellow  
H9265 / F9333 / L9008



Federal Yellow  
G9298 / F9148 / L9003



Saffron Yellow  
H9258 / F9332 / L9007



Citrus  
G9455 / F9334 / L9012



Lime  
H4661 / F4280 / L4011



Citrus Green  
H4691 / F4246 / L4012



Kelly Green  
H4302 / F4088 / L4006



Forest Green  
H4094 / F4105 / L4003



Sea Green  
H4459 / F4212 / L4009

Color chips may vary slightly from manufacturing standards. Custom color matching available. Please check pricing and availability of your chosen color with your local supplier.

# AWLGRIP® / AWLCRAFT® 2000 / AWLCRAFT® SE

BLUE **G** OR **H** CODE NUMBERS = AWLGRIP® / BLACK **F** CODE NUMBERS = AWLCRAFT® 2000 / RED **L** OR **E** CODE NUMBER - AWCRAFT® SE



Sea Foam  
H4256 / F4101 / L4004



Boston Whaler Blue  
H5462 / F5323 / L5015



Island Turquoise  
H5723 / F5624 / L5024



Teal  
H5328 / F5252 / L5011



Brightside Teal  
H4264 / F4281 / L4005



Travel Lift Blue  
H5566 / F5623 / L5020



Petrol Blue  
H5627 / F5476 / L5023

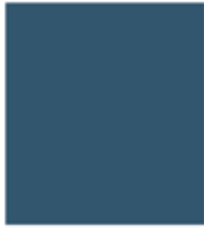

Stars & Stripes Blue  
H5161 / F5194 / L5010



Pigeon Blue  
H5511 / F5538 / L5016



Light Blue  
G5570 / F5516 / L5021



Sky Blue  
G5014 / F5256 / L5006



Bahama Blue  
H5036 / F5418 / L5007



Empress Blue  
H5041 / F5264 / L5008



Marlin Blue  
G5011 / F5015 / L5005



Ocean Blue  
H5545 / F5622 / L5019



Largo Blue  
H5732 / F5625 / L5025



Lauderdale Blue  
G5543 / F5566 / L5018



Navy Blue  
G5001 / F5028 / L5001



Royal Blue  
G5007 / F5011 / L5004



Aristo Blue  
G5003 / F5010 / L5003



Carinthia Blue  
H5342 / F5359 / L5012



Flag Blue  
G5002 / F5014 / L5002



Dark Blue  
H5524 / F5385 / L5017



Mauritius Blue  
H5615 / F5422 / L5022



Jade Mist Green  
G4089 / F4114 / L4002



Donegal Green  
H4492 / F4279 / L4010



Dark Green  
H4024 / F4121 / L4001



Timeless Green  
H4413 / F4168 / L4008



Majestic Blue  
H5409 / F5275 / L5014



Midnight Blue  
H5346 / F5381 / L5013

Color chips may vary slightly from manufacturing standards. Custom color matching available. Please check pricing and availability of your chosen color with your local supplier.

# AWLGRIP® / AWLCRAFT® 2000 / AWLCRAFT® SE

BLUE **G** OR **H** CODE NUMBERS = AWLGRIP® / BLACK **F** CODE NUMBERS = AWLCRAFT® 2000 / RED **L** OR **E** CODE NUMBER - AWLCRAFT® SE

					
Bertram White H8464 / F8510 / L8028	Sand White H8428 / F8286 / L8023	Chalky White H8337 / F8183 / L8016	Morrinsville Double H8647 / F8445 / L8033	Cream H8002 / F8016 / L8010	Lunar White H8413 / F8281 / L8019
					
Hatteras Off-White H8646 / F8300 / L8020	Hatteras Off-White 4208 H8646 / F8256 / L8047	Biscuit H8435 / F8291 / L8027	Light Ivory H8493 / F8512 / L8031	Moon Dust G6004 / F6102 / L6003	Desert Tan H6520 / F6319 / L6013
					
Grand Banks Beige H6421 / F6316 / L6009	Grand Banks Beige 4217 H6523 / F6320 / L6014	Desert Sand H6160 / F6187 / L6008	Castle Tan G6006 / F6014 / L6004	Prairie Beige G6003 / F6012 / L6002	Bristol Beige G6440 / F6317 / L6010
					
Pale Gold * H9182 / F9145 / E9013	Cordovan Gold * H9178 / F9147 / E9014	Bronze G6279 / F6321 / E6010	Super Jet Black G2017 / F2091 / L2001	Shark G1478 / F1441 / L1007	Anthracite Gray H1315 / F1304 / L1010
					
Dark Gray G1344 / F1228 / L1005	Haze Gray H1305 / F1438 / L1005	Medium Gray G1007 / F1010 / L1002	Silver * H1048 / F1195 / E1008	Medium Silver * H1303 / F1265 / E1011	Bright Aluminum * H1021 / F1206 / E1021

Color chips may vary slightly from manufacturing standards. Custom color matching available. Please check pricing and availability of your chosen color with your local supplier.

\* Metallic colors – AWLGRIP® and AWLCRAFT® 2000 is for use on smaller areas ONLY (such as stripes or parts). For larger application areas we recommend AWLCRAFT® SE Metallic finish.



# AWLGRIP® / AWLCRAFT® 2000 / AWLCRAFT® SE

BLUE **G** OR **H** CODE NUMBERS = AWLGRIP® / BLACK **F** CODE NUMBERS = AWLCRAFT® 2000 / RED **L** OR **E** CODE NUMBER = AWLCRAFT® SE

					
Snow White Revisited H8431 / F8289 / L8026	Blue Glo White H8477 / F8325 / L8029	Clipper White H8430 / F8288 / L8025	Snow White G8044 / F8063 / L8007	Cloud White G8089 / F8215 / L8008	Signal White H8386 / F8269 / L8017
					
Blanc Pur H8403 / F8270 / L8018	Oyster White H8139 / F8222 / L8014	Off White G8010 / F8020 / L8004	Stark White H8208 / F8155 / L8015	Insignia White G8022 / F8150 / L8005	Fleet White H8087 / F8185 / L8013
					
Silver White H8427 / F8285 / L8022	Brightside Off-White H8479 / F8511 / L8030	Vanilla White H8429 / F8287 / L8024	Egg Shell White G8105 / F8017 / L8011	Nordic White H8424 / F8509 / L8021	Graystone G1040 / F1182 / L1004
					
Off-White Revisited G8009 / F8166 / L8030	Matterhorn White G8003 / F8024 / L8001	Vestal White G8004 / F8018 / L8002	Blue Tone White G8212 / F8015 / L8009	Ice Blue H5004 / F5021 / L5009	Aqua Mist H4365 / F4126 / L4007
					
Kingston Gray G1359 / F1009 / L1006	Light Gray G1001 / F1007 / L1001	Seattle Gray H1313 / F1343 / L1009	Pearl Gray G1008 / F1196 / L1003	Whisper Gray G8035 / F1204 / L8006	Chevy White H8086 / F8082 / L8012

Color chips may vary slightly from manufacturing standards. Custom color matching available.  
Please check pricing and availability of your chosen color with your local supplier.

[awlgrip.com](http://awlgrip.com)



[facebook.com/awlgripfinishfirst](https://facebook.com/awlgripfinishfirst)



[twitter.com/awlgrip](https://twitter.com/awlgrip)

All trademarks mentioned in this publication are owned by, or licensed to, the AkzoNobel group of companies. © AkzoNobel 2017.

84530167



Freshwater Exclusive



Saltwater Exclusive

## AWLGRIP® Premium Polyester Urethane Topcoat

- A premium quality polyurethane high gloss finish, formulated to deliver a great appearance combined with excellent chemical resistance and hardness.
- Awlgrip topcoat has an easy mix ratio and can be combined with a range of reducers for a flexible application providing incredible results.
- Easy to apply long lasting finish.
- High gloss topcoat with outstanding DOI (distinction of image).
- Stock colors.
- All topcoats are packaged 4 Quarts/Gallons per case.

AWLGRIP



Order No.	Mfg. No. / Description	List Price			
509589	(G1001/1QTUS) Light Gray	Quart	\$80.09	E0-7006000	
509604	(G1007/1QTUS) Medium Gray	Quart	\$75.99	E0-9965000	
509628	(G1008/1QTUS) Pearl Gray	Quart	\$77.99	E0-9485000	
509666	(G1359/1QTUS) Kingston Gray	Quart	\$80.09	E0-7006000	
509692	(G2017/1GLUS) Super Jet Black	Gallon	\$255.39	E0-4519100	
509705	(G2017/1QTUS) Super Jet Black	Quart	\$85.19	E0-9836000	
509731	(G3005/1GLUS) High Gloss Clear	Gallon	\$173.19	E0-9892100	
509743	(G3005/1QTUS) High Gloss Clear	Quart	\$57.69	E0-7234000	
509832	(G5001/1QTUS) Navy Blue	Quart	\$91.59	E0-9686000	
509844	(G5002/1GLUS) Flag Blue	Gallon	\$267.49	E0-2600200	
509856	(G5002/1QTUS) Flag Blue	Quart	\$89.19	E0-9866000	
509870	(G5003/1QTUS) Aristo Blue	Quart	\$89.19	E0-9866000	
509882	(G5007/1GLUS) Royal Blue	Gallon	\$267.49	E0-2600200	
509894	(G5007/1QTUS) Royal Blue	Quart	\$89.19	E0-9866000	
509919	(G6004/1QTUS) Moon Dust	Quart	\$84.19	E0-4136000	
509933	(G7214/1QTUS) Sunfast Red	Quart	\$119.69	E0-7798000	
509971	(G7362/1QTUS) International Orange	Quart	\$119.69	E0-7798000	
509995	(G7367/1QTUS) Vivid Red	Quart	\$113.49	E0-2158000	
510001	(G8003/1GLUS) Matterhorn White	Gallon	\$224.39	E0-9286100	
510013	(G8003/1QTUS) Matterhorn White	Quart	\$74.79	E0-9065000	
510025	(G8004/1GLUS) Vestal White	Gallon	\$224.39	E0-9286100	
510037	(G8004/1QTUS) Vestal White	Quart	\$78.89	E0-7195000	
510075	(G8009/1QTUS) Off-White Revisited	Quart	\$78.89	E0-7195000	
510080	(G8010/1GLUS) Off-White	Gallon	\$224.39	E0-9286100	
510099	(G8010/1QTUS) Off-White	Quart	\$74.79	E0-9065000	

## CONVERTER:

Order No.	Mfg. No. / Description	List Price			
509755	(G3010/1GLUS) #2 Spray	Gallon	\$222.89	E0-7176100	
509779	(G3010/1QTUS) #2 Spray	Quart	\$74.39	E0-9755000	
509767	(G3010/1PTUS) #2 Spray	Pint	\$47.49	E0-2653000	

## EQUIPMENT CLEANING:

Order No.	Mfg. No. / Description	List Price			
510835	(T0001/1GLUS) Fast Spray	Gallon	\$60.59	E0-4454000	
510847	(T0001/1QTUS) Fast Spray	Quart	\$20.19	E0-4151000	
510859	(T0002/1GLUS) Fast Spray	Gallon	\$52.99	E0-4793000	
510873	(T0003/1GLUS) Standard	Gallon	\$60.69	E0-2554000	
510885	(T0003/1QTUS) Standard	Quart	\$20.79	E0-9551000	

Order No.	Mfg. No. / Description	List Price			
510114	(G8022/1QTUS) Insignia White	Quart	\$76.79	E0-9575000	
510126	(G8035/1GLUS) Whisper Gray	Gallon	\$227.79	E0-4807100	
510138	(G8035/1QTUS) Whisper Gray	Quart	\$75.99	E0-9965000	
510140	(G8044/1GLUS) Snow White	Gallon	\$218.79	E0-9046100	
510152	(G8044/1QTUS) Snow White	Quart	\$74.79	E0-9065000	
510164	(G8089/1GLUS) Cloud White	Gallon	\$224.39	E0-9286100	
510176	(G8089/1QTUS) Cloud White	Quart	\$74.79	E0-9065000	
510190	(G8212/1QTUS) Blue Tone White	Quart	\$78.89	E0-7195000	
510239	(G9093/1QTUS) Fighting Lady Yellow	Quart	\$102.49	E0-7867000	
510253	(G9298/1QTUS) Federal Yellow	Quart	\$105.89	E0-2497000	
510417	(H4094/1QTUS) Forest Green	Quart	\$101.89	E0-2467000	
510431	(H4256/1QTUS) Sea Foam	Quart	\$96.69	E0-2527000	
510455	(H4365/1QTUS) Aqua Mist	Quart	\$101.89	E0-2467000	
510479	(H5004/1QTUS) Ice Blue	Quart	\$89.19	E0-9866000	
510493	(H5409/1QTUS) Majestic Blue	Quart	\$92.79	E0-9596000	
510518	(H7161/1QTUS) Toreador Red	Quart	\$119.69	E0-7798000	
510544	(H8002/1GLUS) Cream	Gallon	\$224.39	E0-9286100	
510556	(H8002/1QTUS) Cream	Quart	\$74.79	E0-9065000	
510568	(H8015/1GLUS) Egg Shell White	Gallon	\$224.39	E0-9286100	
510570	(H8015/1QTUS) Egg Shell White	Quart	\$74.79	E0-9065000	
510594	(H8087/1QTUS) Fleet White	Quart	\$78.89	E0-7195000	
510607	(H8139/1GLUS) Oyster White	Gallon	\$224.39	E0-9286100	
510619	(H8139/1QTUS) Oyster White	Quart	\$74.79	E0-9065000	
510621	(H8208/1GLUS) Stark White	Gallon	\$224.39	E0-9286100	
510633	(H8208/1QTUS) Stark White	Quart	\$74.79	E0-9065000	

## REDUCER:

Order No.	Mfg. No. / Description	List Price			
510835	(T0001/1GLUS) Fast Spray	Gallon	\$60.59	E0-4454000	
510847	(T0001/1QTUS) Fast Spray	Quart	\$20.19	E0-4151000	
510859	(T0002/1GLUS) Fast Spray	Gallon	\$52.99	E0-4793000	
510873	(T0003/1GLUS) Standard	Gallon	\$60.69	E0-2554000	
510885	(T0003/1QTUS) Standard	Quart	\$20.79	E0-9551000	
510900	(T0005/1QTUS) Hot Weather	Quart	\$31.99	E0-9932000	

## AWLGRIP® Awlspar Varnish

AWLGRIP

- A classic phenolic tung oil varnish, used for brightwork protection against corrosion and abrasion from water and weather.
- Fast-drying and re-coatable, for quick and flexible application.
- Excellent re-coatability.
- Rich color and deep gloss.
- Highly durable and protective.

Order No.	Mfg. No. / Description	List Price			
510758	(M3131/1QTUS) Quart		\$37.89	E0-2482000	

## BRUSH REDUCER AND EQUIPMENT CLEANING:

Order No.	Mfg. No. / Description	List Price			
510974	(T0016/1QTUS) Quart		\$20.59	E0-4451000	



SPECIAL HANDLING MAY APPLY



Electronics

Trolling Motors

Instruments

Electrical

Lighting

Anchor &amp; Dock

Safety

Steering, Controls

Pumps

Fuel System

Seating &amp; Pedestals

Trailing

Tops &amp; Covers

Perform.

Propellers

Engine &amp; Care

Cleaning &amp; Care

Paint &amp; Paint Acc.

Fun &amp; Flotation

Topside Acc.

Cockpit &amp; Deck

Hardware, Fasteners

Camouflage

Misc.

Comm.

**AWLGRIP® Awlcraft® 2000 - Acrylic Urethane Topcoat**



- A two-component, premium quality acrylic urethane finish.
- Proves an easy-to-apply, high gloss finish in a wide range of colors, including metallic special effect finishes.
- Available in a range of colors and finishes, with enhanced color and gloss retention.
- Provides a buffable, high gloss finish.
- Fast-drying and easy to apply.
- All topcoats are packaged 4 Quarts/Gallons per case.

Order No.	Mfg. No. / Description	List Price			
508854	(F2091/1GLUS) Super Jet Black	Gallon	\$255.39	E0-4519100	
508866	(F2091/1QTUS) Super Jet Black	Quart	\$85.19	E0-9836000	
508878	(F3029/1GLUS) Clear	Gallon	\$170.69	E0-2082100	
508880	(F3029/1QTUS) Clear	Quart	\$58.49	E0-7834000	
508993	(F5010/1GLUS) Aristo Blue	Gallon	\$281.99	E0-9411200	
509008	(F5010/1QTUS) Aristo Blue	Quart	\$100.69	E0-8407000	
509034	(F5014/1GLUS) Flag Blue	Gallon	\$267.49	E0-2600200	
509046	(F5014/1QTUS) Flag Blue	Quart	\$93.99	E0-9407000	
509159	(F7200/1GLUS) Vivid Red	Gallon	\$358.69	E0-2096200	
509161	(F7200/1QTUS) Vivid Red	Quart	\$119.69	E0-7798000	
509274	(F8016/1GLUS) Cream	Gallon	\$230.29	E0-2727100	
509286	(F8016/1QTUS) Cream	Quart	\$78.89	E0-7195000	
509337	(F8020/1GLUS) Off-White	Gallon	\$224.39	E0-9286100	
509349	(F8020/1QTUS) Off-White	Quart	\$78.89	E0-7195000	
509351	(F8024/1GLUS) Matterhorn White	Gallon	\$224.39	E0-9286100	
509363	(F8024/1QTUS) Matterhorn White	Quart	\$74.79	E0-9065000	
509375	(F8063/1GLUS) Snow White	Gallon	\$218.79	E0-9046100	
509387	(F8063/1QTUS) Snow White	Quart	\$74.79	E0-9065000	
509399	(F8150/1GLUS) Insignia White	Gallon	\$236.49	E0-7377100	
509402	(F8150/1QTUS) Insignia White	Quart	\$78.89	E0-7195000	
509414	(F8155/1GLUS) Stark White	Gallon	\$224.39	E0-9286100	
509426	(F8155/1QTUS) Stark White	Quart	\$74.79	E0-9065000	
509438	(F8166/1GLUS) Off-White Revisited	Gallon	\$236.49	E0-7377100	
509476	(F8215/1GLUS) Cloud White	Gallon	\$224.39	E0-9286100	
509488	(F8215/1QTUS) Cloud White	Quart	\$74.79	E0-9065000	
509490	(F8222/1GLUS) Oyster White	Gallon	\$224.39	E0-9286100	
509503	(F8222/1QTUS) Oyster White	Quart	\$74.79	E0-9065000	

**AWLGRIP® Awlmix® Color Matching System**



- Awlcraft 2000 topcoat colors, including special requests for custom colors.
- We request any new formulation from Awlgrip on your behalf and we are able to mix and match most existing formulations.
- By using the Awlmix software provided by Awlgrip, you can be assured we will always have the most current formulations with an extensive choice of colors created by world-wide demand from builders and boat owners.
- The number of formulations in this database grows every month and the input from Awlgrip color chemists is crucial, as each formulation entered is thoroughly reviewed and quality controlled to provide the formulation with the greatest consistency for our day to day operation.
- We can access this information 24/7, all in order to speed up delivery to you.

What will Awlmix do for you?

- Improved service through an added choice of color selection.
- Greater ability to meet increasing customer demand of custom made colors, especially for the OEM or multi-production market.
- Capability to match 48 colors on the Awlcraft 2000 metallic color card.
- Opportunity to provide the color that your customer needs.
- Awlgrip continues to be the premium choice of topsides finishes world-wide.
- Using the Awlmix system to blend Awlgrip and Awlcraft 2000 topcoat colors on site shortens the lead time. Color access is now far beyond the traditional yacht and aerospace paint supplier.
- All colors will be shipped from our Clearwater, Ft. Lauderdale or Norwich facilities with the corresponding shipping times and fees.
- Please supply color code from chart when ordering.

Order No.	Mfg. No. / Description	List Price			
507942	White Based	Gallon	\$246.49	E0-7848100	
507954	White Based	Quart	\$86.39	E0-9746000	
507943	Black Based	Gallon	\$279.49	E0-2690200	
507955	Black Based	Quart	\$93.49	E0-2107000	
507944	Blue Based	Gallon	\$309.89	E0-2423200	
507956	Blue Based	Quart	\$100.69	E0-2557000	
507945	Green Based	Gallon	\$318.89	E0-7193200	
507957	Green Based	Quart	\$111.59	E0-9638000	
507946	Silver Based	Gallon	\$332.59	E0-4494200	
507958	Silver Based	Quart	\$105.09	E0-2887000	
507947	Yellow Based	Gallon	\$393.69	E0-7259200	
507959	Yellow Based	Quart	\$116.39	E0-9278000	
507948	Red Based	Gallon	\$375.09	E0-2318200	
507960	Red Based	Quart	\$132.69	E0-2599000	
507949	Violet Based	Gallon	\$373.89	E0-2408200	
507961	Violet Based	Quart	\$132.89	E0-7699000	
507950	Orange Based	Gallon	\$373.89	E0-2408200	
507962	Orange Based	Quart	\$132.89	E0-7699000	

- Electronics
- Trolling Motors
- Instruments
- Electrical
- Lighting
- Anchor & Dock
- Safety
- Steering, Controls
- Pumps
- Fuel System
- Seating & Pedestals
- Trailer
- Tops & Covers
- Perform.
- Propellers
- Engine & Care
- Cleaning & Care
- Paint & Paint Acc.
- Fun & Flotation
- Topside Acc.
- Cockpit & Deck
- Hardware, Fasteners
- Camouflage
- Misc.
- Comm.

**AWLGRIP® Awlwood Primer**



Order No.	Mfg. No. / Description	List Price			
510699	(J3890/1QTUS) Clear Gloss Finish	Quart	\$80.89	E0-7606000	
510700	(J3890/1GLUS) Clear Gloss Finish	Gallon	\$323.39	E0-4524200	
510697	(J3809/1QTUS) Primer - Clear	Quart	\$79.39	E0-4595000	
510702	(J7809/1QTUS) Primer - Red Tone	Quart	\$83.69	E0-7726000	
510704	(J9809/1QTUS) Primer - Yellow Tone	Quart	\$83.69	E0-7726000	
511116	(T0200/1QTUS) Brush Cleaner	Quart	\$43.39	E0-4523000	
511119	(T0201/1QTUS) Brushing Reducer	Quart	\$31.99	E0-9932000	
511121	(T0202/1QTUS) Spray Reducer	Gallon	\$33.69	E0-7252000	

- Designed for exterior application above the waterline, Awlwood Primer is part of a high-performing Primer & Clear Finish system that adheres directly to wood.
- As natural color fades, this primer helps to establish a permanent rich base color.
- Deeply permeates the grain of the wood, giving long-lasting color stability.
- Improves system flexibility, adhesion and durability.
- Can be applied in a wide range of temperatures and humidities.



**SPECIAL HANDLING MAY APPLY**



AWLGRIP® Awlmix® Color Matching System - Metallic Colors



SILVER/GRAY METALLIC COLORS

Order No.	Mfg. No.	Color	Size	List Price	
2E1001G	(E1001/1GLUS)	Sandalwood	Gallon	\$519.09	E0-2398300
2E1001Q	(E1001/1QTUS)	Sandalwood	Quart	\$213.39	E0-4006100
2E1002G	(E1002/1GLUS)	Golden Gray	Gallon	\$519.09	E0-2398300
2E1002Q	(E1002/1QTUS)	Golden Gray	Quart	\$213.39	E0-4006100
2E1004G	(E1004/1GLUS)	Twilight Gray	Gallon	\$519.09	E0-2398300
2E1004Q	(E1004/1QTUS)	Twilight Gray	Quart	\$213.39	E0-4006100
2E1005G	(E1005/1GLUS)	Moonglow Silver	Gallon	\$519.09	E0-2398300
2E1005Q	(E1005/1QTUS)	Moonglow Silver	Quart	\$213.39	E0-4006100
2E1006G	(E1006/1GLUS)	Stone Gray	Gallon	\$519.09	E0-2398300
2E1006Q	(E1006/1QTUS)	Stone Gray	Quart	\$213.39	E0-4006100
2E1009G	(E1009/1GLUS)	Crystal Silver	Gallon	\$519.09	E0-2398300
2E1009Q	(E1009/1QTUS)	Crystal Silver	Quart	\$213.39	E0-4006100

BLACK METALLIC COLORS

Order No.	Mfg. No.	Color	Size	List Price	
2E2002G	(E2002/1GLUS)	Panther Black	Gallon	\$519.09	E0-2398300
2E2002Q	(E2002/1QTUS)	Panther Black	Quart	\$213.39	E0-4006100
2E2003G	(E2003/1GLUS)	Black Mist	Gallon	\$519.09	E0-2398300
2E2003Q	(E2003/1QTUS)	Black Mist	Quart	\$213.39	E0-4006100

GREEN METALLIC COLORS

Order No.	Mfg. No.	Color	Size	List Price	
2E4001G	(E4001/1GLUS)	Deep Woods Green	Gallon	\$606.39	E0-9745400
2E4001Q	(E4001/1QTUS)	Deep Woods Green	Quart	\$248.29	E0-2268100
2E4002G	(E4002/1GLUS)	Tropical Green	Gallon	\$606.39	E0-9745400
2E4002Q	(E4002/1QTUS)	Tropical Green	Quart	\$248.29	E0-2268100
2E4003G	(E4003/1GLUS)	Verde Green	Gallon	\$606.39	E0-9745400
2E4003Q	(E4003/1QTUS)	Verde Green	Quart	\$248.29	E0-2268100
2E4004G	(E4004/1GLUS)	Cypress Green	Gallon	\$606.39	E0-9745400
2E4004Q	(E4004/1QTUS)	Cypress Green	Quart	\$248.29	E0-2268100
2E4005G	(E4005/1GLUS)	Emerald Green	Gallon	\$606.39	E0-9745400
2E4005Q	(E4005/1QTUS)	Emerald Green	Quart	\$248.29	E0-2268100
2E4006G	(E4006/1GLUS)	Medina Green	Gallon	\$606.39	E0-9745400
2E4006Q	(E4006/1QTUS)	Medina Green	Quart	\$248.29	E0-2268100
2E4007G	(E4007/1GLUS)	Tasmanian Green	Gallon	\$606.39	E0-9745400
2E4007Q	(E4007/1QTUS)	Tasmanian Green	Quart	\$248.29	E0-2268100
2E4008G	(E4008/1GLUS)	Sea Green	Gallon	\$606.39	E0-9745400
2E4008Q	(E4008/1QTUS)	Sea Green	Quart	\$248.29	E0-2268100
2E4009G	(E4009/1GLUS)	Whisper Green	Gallon	\$606.39	E0-9745400
2E4009Q	(E4009/1QTUS)	Whisper Green	Quart	\$248.29	E0-2268100

RED METALLIC COLORS

Order No.	Mfg. No.	Color	Size	List Price	
2E7001G	(E7001/1GLUS)	Redfire	Gallon	\$680.09	E0-7001500
2E7001Q	(E7001/1QTUS)	Redfire	Quart	\$277.79	E0-4380200
2E7002G	(E7002/1GLUS)	Red Raspberry	Gallon	\$680.09	E0-7001500
2E7002Q	(E7002/1QTUS)	Red Raspberry	Quart	\$277.79	E0-4380200
2E7003G	(E7003/1GLUS)	Merlot Red	Gallon	\$680.09	E0-7001500
2E7003Q	(E7003/1QTUS)	Merlot Red	Quart	\$277.79	E0-4380200
2E7004G	(E7004/1GLUS)	Brandywine	Gallon	\$680.09	E0-7001500
2E7004Q	(E7004/1QTUS)	Brandywine	Quart	\$277.79	E0-4380200
2E7005G	(E7005/1GLUS)	Salsa Red	Gallon	\$680.09	E0-7001500
2E7005Q	(E7005/1QTUS)	Salsa Red	Quart	\$277.79	E0-4380200
2E7006G	(E7006/1GLUS)	Cayenne Red	Gallon	\$680.09	E0-7001500
2E7006Q	(E7006/1QTUS)	Cayenne Red	Quart	\$277.79	E0-4380200

BLUE/PURPLE METALLIC COLORS

Order No.	Mfg. No.	Color	Size	List Price	
2E5002G	(E5002/1GLUS)	Mulberry	Gallon	\$519.09	E0-2398300
2E5002Q	(E5002/1QTUS)	Mulberry	Quart	\$213.39	E0-4006100
2E5003G	(E5003/1GLUS)	Purple Passion	Gallon	\$519.09	E0-2398300
2E5003Q	(E5003/1QTUS)	Purple Passion	Quart	\$212.79	E0-9595100
2E5004G	(E5004/1GLUS)	Bahia Blue	Gallon	\$519.09	E0-2398300
2E5004Q	(E5004/1QTUS)	Bahia Blue	Quart	\$213.39	E0-4006100
2E5005G	(E5005/1GLUS)	Caribbean Blue	Gallon	\$519.09	E0-2398300
2E5005Q	(E5005/1QTUS)	Caribbean Blue	Quart	\$213.39	E0-4006100
2E5006G	(E5006/1GLUS)	Tourmarine Blue	Gallon	\$519.09	E0-2398300
2E5006Q	(E5006/1QTUS)	Tourmarine Blue	Quart	\$213.39	E0-4006100
2E5007G	(E5007/1GLUS)	Aquamarine	Gallon	\$519.09	E0-2398300
2E5007Q	(E5007/1QTUS)	Aquamarine	Quart	\$213.39	E0-4006100
2E5008G	(E5008/1GLUS)	Xenon Blue	Gallon	\$519.09	E0-2398300
2E5008Q	(E5008/1QTUS)	Xenon Blue	Quart	\$213.39	E0-4006100
2E5009G	(E5009/1GLUS)	Mid Atlantic Blue	Gallon	\$519.09	E0-2398300
2E5009Q	(E5009/1QTUS)	Mid Atlantic Blue	Quart	\$213.39	E0-4006100
2E5010G	(E5010/1GLUS)	Enchanted Blue	Gallon	\$519.09	E0-2398300
2E5010Q	(E5010/1QTUS)	Enchanted Blue	Quart	\$213.39	E0-4006100
2E5011G	(E5011/1GLUS)	Bright Atlantic Blue	Gallon	\$519.09	E0-2398300
2E5011Q	(E5011/1QTUS)	Bright Atlantic Blue	Quart	\$213.39	E0-4006100
2E5012G	(E5012/1GLUS)	Imperial Blue	Gallon	\$519.09	E0-2398300
2E5012Q	(E5012/1QTUS)	Imperial Blue	Quart	\$213.39	E0-4006100
2E5013G	(E5013/1GLUS)	Blue Steel	Gallon	\$519.09	E0-2398300
2E5013Q	(E5013/1QTUS)	Blue Steel	Quart	\$213.39	E0-4006100
2E5015G	(E5015/1GLUS)	Light Sapphire	Gallon	\$519.09	E0-2398300
2E5015Q	(E5015/1QTUS)	Light Sapphire	Quart	\$213.39	E0-4006100
2E5016G	(E5016/1GLUS)	Robin Blue	Gallon	\$519.09	E0-2398300
2E5016Q	(E5016/1QTUS)	Robin Blue	Quart	\$213.39	E0-4006100
2E5017G	(E5017/1GLUS)	Speedblue	Gallon	\$519.09	E0-2398300
2E5017Q	(E5017/1QTUS)	Speedblue	Quart	\$213.39	E0-4006100
2E5018G	(E5018/1GLUS)	Wisteria Blue	Gallon	\$519.09	E0-2398300
2E5018Q	(E5018/1QTUS)	Wisteria Blue	Quart	\$213.39	E0-4006100
2E5019G	(E5019/1GLUS)	Horizon Blue	Gallon	\$519.09	E0-2398300
2E5019Q	(E5019/1QTUS)	Horizon Blue	Quart	\$213.39	E0-4006100
2E5024G	(E5024/1GLUS)	Glacier Blue	Gallon	\$519.09	E0-2398300
2E5024Q	(E5024/1QTUS)	Glacier Blue	Quart	\$213.39	E0-4006100

BROWN/BEIGE METALLIC COLORS

Order No.	Mfg. No.	Color	Size	List Price	
2E6001G	(E6001/1GLUS)	Brown Sugar	Gallon	\$606.39	E0-9745400
2E6001Q	(E6001/1QTUS)	Brown Sugar	Quart	\$248.29	E0-2268100
2E6002G	(E6002/1GLUS)	Satin Beige	Gallon	\$606.39	E0-9745400
2E6002Q	(E6002/1QTUS)	Satin Beige	Quart	\$248.29	E0-2268100
2E6003G	(E6003/1GLUS)	Brazil Brown	Gallon	\$606.39	E0-9745400
2E6003Q	(E6003/1QTUS)	Brazil Brown	Quart	\$248.29	E0-2268100

GOLD METALLIC COLORS

Order No.	Mfg. No.	Color	Size	List Price	
2E9002G	(E9002/1GLUS)	Citrine Gold	Gallon	\$680.09	E0-7001500
2E9002Q	(E9002/1QTUS)	Citrine Gold	Quart	\$277.79	E0-4380200
2E9003G	(E9003/1GLUS)	Chameleon Gold	Gallon	\$680.09	E0-7001500
2E9003Q	(E9003/1QTUS)	Chameleon Gold	Quart	\$277.79	E0-4380200
2E9004G	(E9004/1GLUS)	Aztec Gold	Gallon	\$680.09	E0-7001500
2E9004Q	(E9004/1QTUS)	Aztec Gold	Quart	\$277.79	E0-4380200
2E9005G	(E9005/1GLUS)	Aurora Gold	Gallon	\$680.09	E0-7001500
2E9005Q	(E9005/1QTUS)	Aurora Gold	Quart	\$277.79	E0-4380200

- Electronics
- Trolling Motors
- Instruments
- Electrical
- Lighting
- Anchor & Dock
- Safety
- Steering, Controls
- Pumps
- Fuel System
- Seating & Pedestals
- Trailering
- Tops & Covers
- Perform.
- Propellers
- Engine & Care
- Cleaning & Care
- Paint & Paint Acc.
- Fun & Flotation
- Topside Acc.
- Cockpit & Deck
- Hardware, Fasteners
- Camouflage
- Misc.
- Comm.

## AWLGRIP® Awlmix® Color Matching System - Awlcraft® 2000 Colors

# AWLGRIP®

Order No.	Mfg. No.	Color	Size	List Price	
2F1007G	(F1007/1GLUS)	Light Gray	Gallon	\$253.49	EO-2109100
2F1007Q	(F1007/1QTUS)	Light Gray	Quart	\$99.19	EO-9347000
2F1009G	(F1009/1GLUS)	Kingston Gray	Gallon	\$253.49	EO-2109100
2F1009Q	(F1009/1QTUS)	Kingston Gray	Quart	\$99.19	EO-9347000
2F1010G	(F1010/1GLUS)	Medium Gray	Gallon	\$253.49	EO-2109100
2F1010Q	(F1010/1QTUS)	Medium Gray	Quart	\$99.19	EO-9347000
2F1182G	(F1182/1GLUS)	Graystone	Gallon	\$253.49	EO-2109100
2F1182Q	(F1182/1QTUS)	Graystone	Quart	\$99.19	EO-9347000
2F1195G	(F1195/1GLUS)	Silver	Gallon	\$334.29	EO-2705200
2F1195Q	(F1195/1QTUS)	Silver	Quart	\$118.69	EO-2098000
2F1196G	(F1196/1GLUS)	Pearl Gray	Gallon	\$253.49	EO-2109100
2F1196Q	(F1196/1QTUS)	Pearl Gray	Quart	\$99.19	EO-9347000
2F1204G	(F1204/1GLUS)	Whisper Gray	Gallon	\$253.49	EO-2109100
2F1204Q	(F1204/1QTUS)	Whisper Gray	Quart	\$99.19	EO-9347000
2F1206G	(F1206/1GLUS)	Bright Aluminum	Gallon	\$334.29	EO-2705200
2F1206Q	(F1206/1QTUS)	Bright Aluminum	Quart	\$118.69	EO-2098000
2F1228G	(F1228/1GLUS)	Dark Gray	Gallon	\$253.49	EO-2109100
2F1228Q	(F1228/1QTUS)	Dark Gray	Quart	\$99.19	EO-9347000
2F1247G	(F1247/1GLUS)	Silver Metal - Medium	Gallon	\$320.89	EO-7604200
2F1248G	(F1248/1GLUS)	Silver Metal - Large	Gallon	\$320.89	EO-7604200
2F1265G	(F1265/1GLUS)	Medium Silver	Gallon	\$334.29	EO-2705200
2F1265Q	(F1265/1QTUS)	Medium Silver	Quart	\$118.69	EO-2098000
2F1304G	(F1304/1GLUS)	Anthracite Gray	Gallon	\$253.49	EO-2109100
2F1304Q	(F1304/1QTUS)	Anthracite Gray	Quart	\$99.19	EO-9347000
2F1343G	(F1343/1GLUS)	Seattle Gray	Gallon	\$253.49	EO-2109100
2F1343Q	(F1343/1QTUS)	Seattle Gray	Quart	\$99.19	EO-9347000
2F1438G	(F1438/1GLUS)	Haze Gray	Gallon	\$253.49	EO-2109100
2F1438Q	(F1438/1QTUS)	Haze Gray	Quart	\$99.19	EO-9347000
2F1441G	(F1441/1GLUS)	Shark	Gallon	\$253.49	EO-2109100
2F1441Q	(F1441/1QTUS)	Shark	Quart	\$99.19	EO-9347000
2F2091G	(F2091/1GLUS)	Super Jet Black	Gallon	\$331.79	EO-4884200
2F2091Q	(F2091/1QTUS)	Super Jet Black	Quart	\$106.49	EO-7897000
2F3029G	(F3029/1GLUS)	Clear	Gallon	\$253.49	EO-2109100
2F3029Q	(F3029/1QTUS)	Clear	Quart	\$91.69	EO-7786000
2F4088G	(F4088/1GLUS)	Kelly Green	Gallon	\$320.89	EO-7604200
2F4088Q	(F4088/1QTUS)	Kelly Green	Quart	\$114.19	EO-4658000
2F4101G	(F4101/1GLUS)	Sea Foam	Gallon	\$320.89	EO-7604200
2F4101Q	(F4101/1QTUS)	Sea Foam	Quart	\$114.19	EO-4658000
2F4105G	(F4105/1GLUS)	Forest Green	Gallon	\$320.89	EO-7604200
2F4105Q	(F4105/1QTUS)	Forest Green	Quart	\$114.19	EO-4658000
2F4114G	(F4114/1GLUS)	Jade Mist Green	Gallon	\$320.89	EO-7604200
2F4114Q	(F4114/1QTUS)	Jade Mist Green	Quart	\$114.19	EO-4658000
2F4121G	(F4121/1GLUS)	Dark Green	Gallon	\$320.89	EO-7604200
2F4121Q	(F4121/1QTUS)	Dark Green	Quart	\$114.19	EO-4658000
2F4126G	(F4126/1GLUS)	Aqua Mist	Gallon	\$320.89	EO-7604200
2F4126Q	(F4126/1QTUS)	Aqua Mist	Quart	\$114.19	EO-4658000
2F4168G	(F4168/1GLUS)	Timeless Green	Gallon	\$320.89	EO-7604200
2F4168Q	(F4168/1QTUS)	Timeless Green	Quart	\$114.19	EO-4658000
2F4212G	(F4212/1GLUS)	Sea Green	Gallon	\$320.89	EO-7604200
2F4212Q	(F4212/1QTUS)	Sea Green	Quart	\$114.19	EO-4658000
2F4246G	(F4246/1GLUS)	Citrus Green	Gallon	\$320.89	EO-7604200
2F4246Q	(F4246/1QTUS)	Citrus Green	Quart	\$114.19	EO-4658000
2F4279G	(F4279/1GLUS)	Donegal Green	Gallon	\$320.89	EO-7604200
2F4279Q	(F4279/1QTUS)	Donegal Green	Quart	\$114.19	EO-4658000
2F4280G	(F4280/1GLUS)	Lime	Gallon	\$320.89	EO-7604200
2F4280Q	(F4280/1QTUS)	Lime	Quart	\$114.19	EO-4658000
2F4281G	(F4281/1GLUS)	Brightside Teal	Gallon	\$320.89	EO-7604200
2F4281Q	(F4281/1QTUS)	Brightside Teal	Quart	\$114.19	EO-4658000
2F5010G	(F5010/1GLUS)	Aristo Blue	Gallon	\$331.79	EO-4884200
2F5010Q	(F5010/1QTUS)	Aristo Blue	Quart	\$106.49	EO-7897000
2F5011G	(F5011/1GLUS)	Royal Blue	Gallon	\$331.79	EO-4884200
2F5011Q	(F5011/1QTUS)	Royal Blue	Quart	\$106.49	EO-7897000

Order No.	Mfg. No.	Color	Size	List Price	
2F5014G	(F5014/1GLUS)	Flag Blue	Gallon	\$331.79	EO-4884200
2F5014Q	(F5014/1QTUS)	Flag Blue	Quart	\$106.49	EO-7897000
2F5015G	(F5015/1GLUS)	Marlin Blue	Gallon	\$331.79	EO-4884200
2F5015Q	(F5015/1QTUS)	Marlin Blue	Quart	\$106.49	EO-7897000
2F5021G	(F5021/1GLUS)	Ice Blue	Gallon	\$331.79	EO-4884200
2F5021Q	(F5021/1QTUS)	Ice Blue	Quart	\$106.49	EO-7897000
2F5028G	(F5028/1GLUS)	Navy Blue	Gallon	\$331.79	EO-4884200
2F5028Q	(F5028/1QTUS)	Navy Blue	Quart	\$106.49	EO-7897000
2F5194G	(F5194/1GLUS)	Stars & Stripes Blue	Gallon	\$331.79	EO-4884200
2F5194Q	(F5194/1QTUS)	Stars & Stripes Blue	Quart	\$106.49	EO-7897000
2F5252G	(F5252/1GLUS)	Teal	Gallon	\$331.79	EO-4884200
2F5252Q	(F5252/1QTUS)	Teal	Quart	\$106.49	EO-7897000
2F5256G	(F5256/1GLUS)	Sky Blue	Gallon	\$331.79	EO-4884200
2F5256Q	(F5256/1QTUS)	Sky Blue	Quart	\$106.49	EO-7897000
2F5264G	(F5264/1GLUS)	Empress Blue	Gallon	\$331.79	EO-4884200
2F5264Q	(F5264/1QTUS)	Empress Blue	Quart	\$106.49	EO-7897000
2F5275G	(F5275/1GLUS)	Majestic Blue	Gallon	\$331.79	EO-4884200
2F5275Q	(F5275/1QTUS)	Majestic Blue	Quart	\$106.49	EO-7897000
2F5323G	(F5323/1GLUS)	Boston Whaler Blue	Gallon	\$331.79	EO-4884200
2F5323Q	(F5323/1QTUS)	Boston Whaler Blue	Quart	\$106.49	EO-7897000
2F5359G	(F5359/1GLUS)	Carinthia Blue	Gallon	\$331.79	EO-4884200
2F5359Q	(F5359/1QTUS)	Carinthia Blue	Quart	\$106.49	EO-7897000
2F5381G	(F5381/1GLUS)	Midnight Blue	Gallon	\$331.79	EO-4884200
2F5381Q	(F5381/1QTUS)	Midnight Blue	Quart	\$106.49	EO-7897000
2F5385G	(F5385/1GLUS)	Dark Blue	Gallon	\$331.79	EO-4884200
2F5385Q	(F5385/1QTUS)	Dark Blue	Quart	\$106.49	EO-7897000
2F5418G	(F5418/1GLUS)	Bahama Blue	Gallon	\$331.79	EO-4884200
2F5418Q	(F5418/1QTUS)	Bahama Blue	Quart	\$106.49	EO-7897000
2F5422G	(F5422/1GLUS)	Mauritius Blue	Gallon	\$331.79	EO-4884200
2F5422Q	(F5422/1QTUS)	Mauritius Blue	Quart	\$106.49	EO-7897000
2F5476G	(F5476/1GLUS)	Petrol Blue	Gallon	\$331.79	EO-4884200
2F5476Q	(F5476/1QTUS)	Petrol Blue	Quart	\$106.49	EO-7897000
2F5516G	(F5516/1GLUS)	Light Blue	Gallon	\$331.79	EO-4884200
2F5516Q	(F5516/1QTUS)	Light Blue	Quart	\$106.49	EO-7897000
2F5538G	(F5538/1GLUS)	Pigeon Blue	Gallon	\$331.79	EO-4884200
2F5538Q	(F5538/1QTUS)	Pigeon Blue	Quart	\$106.49	EO-7897000
2F5566G	(F5566/1GLUS)	Lauderdale Blue	Gallon	\$331.79	EO-4884200
2F5566Q	(F5566/1QTUS)	Lauderdale Blue	Quart	\$106.49	EO-7897000
2F5622G	(F5622/1GLUS)	Ocean Blue	Gallon	\$331.79	EO-4884200
2F5622Q	(F5622/1QTUS)	Ocean Blue	Quart	\$106.49	EO-7897000
2F5623G	(F5623/1GLUS)	Travel Lift Blue	Gallon	\$331.79	EO-4884200
2F5623Q	(F5623/1QTUS)	Travel Lift Blue	Quart	\$106.49	EO-7897000
2F5624G	(F5624/1GLUS)	Island Turquoise	Gallon	\$331.79	EO-4884200
2F5624Q	(F5624/1QTUS)	Island Turquoise	Quart	\$106.49	EO-7897000
2F5625G	(F5625/1GLUS)	Largo Blue	Gallon	\$331.79	EO-4884200
2F5625Q	(F5625/1QTUS)	Largo Blue	Quart	\$106.49	EO-7897000
2F6012G	(F6012/1GLUS)	Prairie Beige	Gallon	\$275.79	EO-4860200
2F6012Q	(F6012/1QTUS)	Prairie Beige	Quart	\$99.19	EO-9347000
2F6014G	(F6014/1GLUS)	Castle Tan	Gallon	\$275.79	EO-4860200
2F6014Q	(F6014/1QTUS)	Castle Tan	Quart	\$99.19	EO-9347000
2F6017G	(F6017/1GLUS)	Sahara Tan	Gallon	\$275.79	EO-4860200
2F6017Q	(F6017/1QTUS)	Sahara Tan	Quart	\$99.19	EO-9347000
2F6102G	(F6102/1GLUS)	Moon Dust	Gallon	\$275.79	EO-4860200
2F6102Q	(F6102/1QTUS)	Moon Dust	Quart	\$99.19	EO-9347000
2F6171G	(F6171/1GLUS)	Sable Brown	Gallon	\$275.79	EO-4860200
2F6171Q	(F6171/1QTUS)	Sable Brown	Quart	\$99.19	EO-9347000
2F6187G	(F6187/1GLUS)	Desert Sand	Gallon	\$275.79	EO-4860200
2F6187Q	(F6187/1QTUS)	Desert Sand	Quart	\$99.19	EO-9347000
2F6280G	(F6280/1GLUS)	Catboat Tan	Gallon	\$275.79	EO-4860200
2F6280Q	(F6280/1QTUS)	Catboat Tan	Quart	\$99.19	EO-9347000
2F6286G	(F6286/1GLUS)	Mocha	Gallon	\$275.79	EO-4860200
2F6286Q	(F6286/1QTUS)	Mocha	Quart	\$99.19	EO-9347000





Freshwater Exclusive



Saltwater Exclusive

## AWLGRIP® Awlmix® Color Matching System - Awlcraft® 2000 Colors

**AWLGRIP**

Order No.	Mfg. No.	Color	Size	List Price	Order No.	Mfg. No.	Color	Size	List Price
2F6316G	(F6316/1GLUS)	Grand Banks Beige	Gallon	\$275.79	E0-4860200				
2F6316Q	(F6316/1QTUS)	Grand Banks Beige	Quart	\$99.19	E0-9347000				
2F6317G	(F6317/1GLUS)	Bristol Beige	Gallon	\$275.79	E0-4860200				
2F6317Q	(F6317/1QTUS)	Bristol Beige	Quart	\$99.19	E0-9347000				
2F6318G	(F6318/1GLUS)	Horizons Teak	Gallon	\$275.79	E0-4860200				
2F6318Q	(F6318/1QTUS)	Horizons Teak	Quart	\$99.19	E0-9347000				
2F6319G	(F6319/1GLUS)	Desert Tan	Gallon	\$275.79	E0-4860200				
2F6319Q	(F6319/1QTUS)	Desert Tan	Quart	\$99.19	E0-9347000				
2F6320G	(F6320/1GLUS)	Grand Banks Beige 4217	Gallon	\$275.79	E0-4860200				
2F6320Q	(F6320/1QTUS)	Grand Banks Beige 4217	Quart	\$99.19	E0-9347000				
2F6321G	(F6321/1GLUS)	Bronze	Gallon	\$334.29	E0-2705200				
2F6321Q	(F6321/1QTUS)	Bronze	Quart	\$118.69	E0-2098000				
2F7029G	(F7029/1GLUS)	Claret	Gallon	\$372.79	E0-9597200				
2F7029Q	(F7029/1QTUS)	Claret	Quart	\$131.89	E0-2989000				
2F7200G	(F7200/1GLUS)	Vivid Red	Gallon	\$372.79	E0-9597200				
2F7200Q	(F7200/1QTUS)	Vivid Red	Quart	\$131.89	E0-2989000				
2F7232G	(F7232/1GLUS)	Toreador Red	Gallon	\$372.79	E0-9597200				
2F7232Q	(F7232/1QTUS)	Toreador Red	Quart	\$131.89	E0-2989000				
2F7233G	(F7233/1GLUS)	International Orange	Gallon	\$372.79	E0-9597200				
2F7233Q	(F7233/1QTUS)	International Orange	Quart	\$131.89	E0-2989000				
2F7242G	(F7242/1GLUS)	Sunfast Red	Gallon	\$372.79	E0-9597200				
2F7242Q	(F7242/1QTUS)	Sunfast Red	Quart	\$131.89	E0-2989000				
2F7252G	(F7252/1GLUS)	Red Mahogany	Gallon	\$372.79	E0-9597200				
2F7252Q	(F7252/1QTUS)	Red Mahogany	Quart	\$131.89	E0-2989000				
2F7286G	(F7286/1GLUS)	Hot Pink	Gallon	\$372.79	E0-9597200				
2F7286Q	(F7286/1QTUS)	Hot Pink	Quart	\$131.89	E0-2989000				
2F7320G	(F7320/1GLUS)	Cabernet Burgundy	Gallon	\$372.79	E0-9597200				
2F7320Q	(F7320/1QTUS)	Cabernet Burgundy	Quart	\$131.89	E0-2989000				
2F7321G	(F7321/1GLUS)	Rochelle Red	Gallon	\$372.79	E0-9597200				
2F7321Q	(F7321/1QTUS)	Rochelle Red	Quart	\$131.89	E0-2989000				
2F7356G	(F7356/1GLUS)	Soft Pink	Gallon	\$372.79	E0-9597200				
2F7356Q	(F7356/1QTUS)	Soft Pink	Quart	\$131.89	E0-2989000				
2F7413G	(F7413/1GLUS)	Sarafsa Red	Gallon	\$372.79	E0-9597200				
2F7413Q	(F7413/1QTUS)	Sarafsa Red	Quart	\$131.89	E0-2989000				
2F7414G	(F7414/1GLUS)	Bright Red Orange	Gallon	\$372.79	E0-9597200				
2F7414Q	(F7414/1QTUS)	Bright Red Orange	Quart	\$131.89	E0-2989000				
2F8015G	(F8015/1GLUS)	Blue Tone White	Gallon	\$253.49	E0-2109100				
2F8015Q	(F8015/1QTUS)	Blue Tone White	Quart	\$91.69	E0-7786000				
2F8016G	(F8016/1GLUS)	Cream	Gallon	\$253.49	E0-2109100				
2F8016Q	(F8016/1QTUS)	Cream	Quart	\$91.69	E0-7786000				
2F8017G	(F8017/1GLUS)	Egg Shell White	Gallon	\$253.49	E0-2109100				
2F8017Q	(F8017/1QTUS)	Egg Shell White	Quart	\$91.69	E0-7786000				
2F8018G	(F8018/1GLUS)	Vestal White	Gallon	\$253.49	E0-2109100				
2F8018Q	(F8018/1QTUS)	Vestal White	Quart	\$91.69	E0-7786000				
2F8020G	(F8020/1GLUS)	Off White	Gallon	\$253.49	E0-2109100				
2F8020Q	(F8020/1QTUS)	Off White	Quart	\$91.69	E0-7786000				
2F8024G	(F8024/1GLUS)	Matterhorn White	Gallon	\$253.49	E0-2109100				
2F8024Q	(F8024/1QTUS)	Matterhorn White	Quart	\$91.69	E0-7786000				
2F8063G	(F8063/1GLUS)	Snow White	Gallon	\$253.49	E0-2109100				
2F8063Q	(F8063/1QTUS)	Snow White	Quart	\$91.69	E0-7786000				
2F8082G	(F8082/1GLUS)	Chevy White	Gallon	\$253.49	E0-2109100				
2F8082Q	(F8082/1QTUS)	Chevy White	Quart	\$91.69	E0-7786000				
2F8150G	(F8150/1GLUS)	Insignia White	Gallon	\$253.49	E0-2109100				
2F8150Q	(F8150/1QTUS)	Insignia White	Quart	\$91.69	E0-7786000				
2F8155G	(F8155/1GLUS)	Stark White	Gallon	\$253.49	E0-2109100				
2F8155Q	(F8155/1QTUS)	Stark White	Quart	\$91.69	E0-7786000				
2F8166G	(F8166/1GLUS)	Off-White Revisited	Gallon	\$253.49	E0-2109100				
2F8166Q	(F8166/1QTUS)	Off-White Revisited	Quart	\$91.69	E0-7786000				
2F8183G	(F8183/1GLUS)	Chalky White	Gallon	\$253.49	E0-2109100				
2F8183Q	(F8183/1QTUS)	Chalky White	Quart	\$91.69	E0-7786000				
2F8185G	(F8185/1GLUS)	Fleet White	Gallon	\$253.49	E0-2109100				
2F8185Q	(F8185/1QTUS)	Fleet White	Quart	\$91.69	E0-7786000				
2F8215G	(F8215/1GLUS)	Cloud White	Gallon	\$253.49	E0-2109100				
2F8215Q	(F8215/1QTUS)	Cloud White	Quart	\$91.69	E0-7786000				
2F8222G	(F8222/1GLUS)	Oyster White	Gallon	\$253.49	E0-2109100				
2F8222Q	(F8222/1QTUS)	Oyster White	Quart	\$91.69	E0-7786000				
2F8256G	(F8256/1GLUS)	Hatteras Off-White 4208	Gallon	\$253.49	E0-2109100				
2F8256Q	(F8256/1QTUS)	Hatteras Off-White 4208	Quart	\$91.69	E0-7786000				
2F8269G	(F8269/1GLUS)	Signal White	Gallon	\$253.49	E0-2109100				
2F8269Q	(F8269/1QTUS)	Signal White	Quart	\$91.69	E0-7786000				
2F8270G	(F8270/1GLUS)	Blanc Pur	Gallon	\$253.49	E0-2109100				
2F8270Q	(F8270/1QTUS)	Blanc Pur	Quart	\$91.69	E0-7786000				
2F8281G	(F8281/1GLUS)	Lunar White	Gallon	\$253.49	E0-2109100				
2F8281Q	(F8281/1QTUS)	Lunar White	Quart	\$91.69	E0-7786000				
2F8285G	(F8285/1GLUS)	Silver White	Gallon	\$253.49	E0-2109100				
2F8285Q	(F8285/1QTUS)	Silver White	Quart	\$91.69	E0-7786000				
2F8286G	(F8286/1GLUS)	Sand White	Gallon	\$253.49	E0-2109100				
2F8286Q	(F8286/1QTUS)	Sand White	Quart	\$91.69	E0-7786000				
2F8287G	(F8287/1GLUS)	Vanilla White	Gallon	\$253.49	E0-2109100				
2F8287Q	(F8287/1QTUS)	Vanilla White	Quart	\$91.69	E0-7786000				
2F8288G	(F8288/1GLUS)	Clipper White	Gallon	\$253.49	E0-2109100				
2F8288Q	(F8288/1QTUS)	Clipper White	Quart	\$91.69	E0-7786000				
2F8289G	(F8289/1GLUS)	Snow White Revisited	Gallon	\$253.49	E0-2109100				
2F8289Q	(F8289/1QTUS)	Snow White Revisited	Quart	\$91.69	E0-7786000				
2F8291G	(F8291/1GLUS)	Biscuit	Gallon	\$253.49	E0-2109100				
2F8291Q	(F8291/1QTUS)	Biscuit	Quart	\$91.69	E0-7786000				
2F8300G	(F8300/1GLUS)	Hatteras Off-White	Gallon	\$253.49	E0-2109100				
2F8300Q	(F8300/1QTUS)	Hatteras Off-White	Quart	\$91.69	E0-7786000				
2F8325G	(F8325/1GLUS)	Blue Glo White	Gallon	\$253.49	E0-2109100				
2F8325Q	(F8325/1QTUS)	Blue Glo White	Quart	\$91.69	E0-7786000				
2F8445G	(F8445/1GLUS)	Morrinsville Double	Gallon	\$253.49	E0-2109100				
2F8445Q	(F8445/1QTUS)	Morrinsville Double	Quart	\$91.69	E0-7786000				
2F8509G	(F8509/1GLUS)	Nordic White	Gallon	\$253.49	E0-2109100				
2F8509Q	(F8509/1QTUS)	Nordic White	Quart	\$91.69	E0-7786000				
2F8510G	(F8510/1GLUS)	Bertram White	Gallon	\$253.49	E0-2109100				
2F8510Q	(F8510/1QTUS)	Bertram White	Quart	\$91.69	E0-7786000				
2F8511G	(F8511/1GLUS)	Brightside Off-White	Gallon	\$253.49	E0-2109100				
2F8511Q	(F8511/1QTUS)	Brightside Off-White	Quart	\$91.69	E0-7786000				
2F8512G	(F8512/1GLUS)	Light Ivory	Gallon	\$253.49	E0-2109100				
2F8512Q	(F8512/1QTUS)	Light Ivory	Quart	\$91.69	E0-7786000				
2F9014G	(F9014/1GLUS)	San Mateo Wheat	Gallon	\$275.79	E0-4860200				
2F9014Q	(F9014/1QTUS)	San Mateo Wheat	Quart	\$99.19	E0-9347000				
2F9120G	(F9120/1GLUS)	Fighting Lady Yellow	Gallon	\$334.29	E0-2705200				
2F9120Q	(F9120/1QTUS)	Fighting Lady Yellow	Quart	\$114.19	E0-4658000				
2F9145Q	(F9145/1QTUS)	Pale Gold	Quart	\$193.79	E0-4354100				
2F9147Q	(F9147/1QTUS)	Cordovan Gold	Quart	\$198.19	E0-4684100				
2F9148G	(F9148/1GLUS)	Federal Yellow	Gallon	\$349.29	E0-7916200				
2F9148Q	(F9148/1QTUS)	Federal Yellow	Quart	\$123.69	E0-7729000				
2F9316G	(F9316/1GLUS)	Yellow	Gallon	\$349.29	E0-7916200				
2F9316Q	(F9316/1QTUS)	Yellow	Quart	\$123.69	E0-7729000				
2F9327G	(F9327/1GLUS)	Vermillion	Gallon	\$372.79	E0-9597200				
2F9327Q	(F9327/1QTUS)	Vermillion	Quart	\$131.89	E0-2989000				
2F9332G	(F9332/1GLUS)	Saffron Yellow	Gallon	\$349.29	E0-7916200				
2F9332Q	(F9332/1QTUS)	Saffron Yellow	Quart	\$123.69	E0-7729000				
2F9333G	(F9333/1GLUS)	Lemon Yellow	Gallon	\$349.29	E0-7916200				
2F9333Q	(F9333/1QTUS)	Lemon Yellow	Quart	\$123.69	E0-7729000				
2F9334G	(F9334/1GLUS)	Citrus	Gallon	\$320.89	E0-7604200				
2F9334Q	(F9334/1QTUS)	Citrus	Quart	\$114.19	E0-4658000				

Electronics

Trolling Motors

Instruments

Electrical

Lighting

Anchor &amp; Dock

Safety

Steering, Controls

Pumps

Fuel System

Seating &amp; Pedestals

Trailing

Tops &amp; Covers

Perform.

Propellers

Engine &amp; Care

Cleaning &amp; Care

Paint &amp; Paint Acc.

Fun &amp; Flotation

Topside Acc.

Cockpit &amp; Deck

Hardware, Fasteners

Camouflage

Misc.

Comm.



AWLGRIP® Awlmix® Color Matching System - Awlgrip® Colors



Paint & Paint Acc.

- Electronics
- Trolling Motors
- Instruments
- Electrical
- Lighting
- Anchor & Dock
- Safety
- Steering, Controls
- Pumps
- Fuel System
- Seating & Pedestals
- Trailer
- Tops & Covers
- Perform.
- Propellers
- Engine & Care
- Cleaning & Care
- Paint & Paint Acc.
- Fun & Flotation
- Topside Acc.
- Cockpit & Deck
- Hardware, Fasteners
- Camouflage
- Misc.
- Comm.

Order No.	Mfg. No.	Color	Size	List Price	
2G1001G	(G1001/1GLUS)	Light Gray	Gallon	\$253.49	E0-2109100
2G1001Q	(G1001/1QTUS)	Light Gray	Quart	\$99.19	E0-9347000
2G1007G	(G1007/1GLUS)	Medium Gray	Gallon	\$253.49	E0-2109100
2G1007Q	(G1007/1QTUS)	Medium Gray	Quart	\$99.19	E0-9347000
2G1008G	(G1008/1GLUS)	Pearl Gray	Gallon	\$253.49	E0-2109100
2G1008Q	(G1008/1QTUS)	Pearl Gray	Quart	\$99.19	E0-9347000
2G1040G	(G1040/1GLUS)	Graystone	Gallon	\$253.49	E0-2109100
2G1040Q	(G1040/1QTUS)	Graystone	Quart	\$99.19	E0-9347000
2G1344G	(G1344/1GLUS)	Dark Gray	Gallon	\$253.49	E0-2109100
2G1344Q	(G1344/1QTUS)	Dark Gray	Quart	\$99.19	E0-9347000
2G1359G	(G1359/1GLUS)	Kingston Gray	Gallon	\$253.49	E0-2109100
2G1359Q	(G1359/1QTUS)	Kingston Gray	Quart	\$99.19	E0-9347000
2G1389G	(G1389/1GLUS)	Silver Metal - Med.	Gallon	\$313.39	E0-4053200
2G1390G	(G1390/1GLUS)	Silver Metal - Large	Gallon	\$313.39	E0-4053200
2G1478G	(G1478/1GLUS)	Shark	Gallon	\$253.49	E0-2109100
2G1478Q	(G1478/1QTUS)	Shark	Quart	\$99.19	E0-9347000
2G2002G	(G2002/1GLUS)	Flat Black	Gallon	\$297.79	E0-4332200
2G2002Q	(G2002/1QTUS)	Flat Black	Quart	\$106.49	E0-7897000
2G2017G	(G2017/1GLUSM)	Super Jet Black	Gallon	\$297.79	E0-4332200
2G2017Q	(G2017/1QTUS)	Super Jet Black	Quart	\$106.49	E0-7897000
2G5001G	(G5001/1GLUS)	Navy Blue	Gallon	\$297.79	E0-4332200
2G5001Q	(G5001/1QTUS)	Navy Blue	Quart	\$106.49	E0-7897000
2G5002G	(G5002/1GLUS)	Flag Blue	Gallon	\$297.79	E0-4332200
2G5002Q	(G5002/1QTUS)	Flag Blue	Quart	\$106.49	E0-7897000
2G5003G	(G5003/1GLUS)	Aristo Blue	Gallon	\$297.79	E0-4332200
2G5003Q	(G5003/1QTUS)	Aristo Blue	Quart	\$106.49	E0-7897000
2G5007G	(G5007/1GLUS)	Royal Blue	Gallon	\$297.79	E0-4332200
2G5007Q	(G5007/1QTUS)	Royal Blue	Quart	\$106.49	E0-7897000
2G5011G	(G5011/1GLUS)	Marlin Blue	Gallon	\$297.79	E0-4332200
2G5011Q	(G5011/1QTUS)	Marlin Blue	Quart	\$106.49	E0-7897000
2G5014G	(G5014/1GLUS)	Sky Blue	Gallon	\$297.79	E0-4332200
2G5014Q	(G5014/1QTUS)	Sky Blue	Quart	\$106.49	E0-7897000
2G5036G	(G5036/1GLUS)	Bahama Blue	Gallon	\$297.79	E0-4332200
2G5036Q	(G5036/1QTUS)	Bahama Blue	Quart	\$106.49	E0-7897000
2G5041G	(G5041/1GLUS)	Empress Blue	Gallon	\$297.79	E0-4332200
2G5041Q	(G5041/1QTUS)	Empress Blue	Quart	\$106.49	E0-7897000
2G6001G	(G6001/1GLUS)	Sable Brown	Gallon	\$275.79	E0-4860200
2G6001Q	(G6001/1QTUS)	Sable Brown	Quart	\$99.19	E0-9347000
2G6003G	(G6003/1GLUS)	Prairie Beige	Gallon	\$275.79	E0-4860200
2G6004G	(G6004/1GLUS)	Moon Dust	Gallon	\$275.79	E0-4860200
2G6004Q	(G6004/1QTUS)	Moon Dust	Quart	\$99.19	E0-9347000
2G6006G	(G6006/1GLUS)	Castle Tan	Gallon	\$275.79	E0-4860200
2G6006Q	(G6006/1QTUS)	Castle Tan	Quart	\$99.19	E0-9347000
2G6009G	(G6009/1GLUS)	Sahara Tan	Gallon	\$275.79	E0-4860200
2G6009Q	(G6009/1QTUS)	Sahara Tan	Quart	\$99.19	E0-9347000
2G6279G	(G6279/1GLUS)	Bronze	Gallon	\$372.79	E0-9597200
2G6279Q	(G6279/1QTUS)	Bronze	Quart	\$118.69	E0-2098000
2G6324G	(G6324/1GLUS)	Mocha	Gallon	\$268.69	E0-2510200
2G6324Q	(G6324/1QTUS)	Mocha	Quart	\$99.19	E0-9347000
2G7022G	(G7022/1GLUS)	Red Mahogany	Gallon	\$372.79	E0-9597200
2G7022Q	(G7022/1QTUS)	Red Mahogany	Quart	\$131.49	E0-2689000
2G7214G	(G7214/1GLUS)	Sunfast Red	Gallon	\$349.99	E0-9426200
2G7214Q	(G7214/1QTUS)	Sunfast Red	Quart	\$131.49	E0-2689000
2G7305G	(G7305/1GLUS)	Claret	Gallon	\$349.99	E0-9426200
2G7305Q	(G7305/1QTUS)	Claret	Quart	\$131.49	E0-2689000
2G7362G	(G7362/1GLUS)	International Orange	Gallon	\$372.79	E0-9597200
2G7362Q	(G7362/1QTUS)	International Orange	Quart	\$131.49	E0-2689000
2G7367G	(G7367/1GLUS)	Vivid Red	Gallon	\$372.79	E0-9597200
2G7367Q	(G7367/1QTUS)	Vivid Red	Quart	\$131.49	E0-2689000

Order No.	Mfg. No.	Color	Size	List Price	
2G7446G	(G7446/1GLUS)	Sarafs Red	Gallon	\$372.79	E0-9597200
2G7446Q	(G7446/1QTUS)	Sarafs Red	Quart	\$131.49	E0-2689000
2G7483G	(G7483/1GLUS)	Bright Red Orange	Gallon	\$372.79	E0-9597200
2G7483Q	(G7483/1QTUS)	Bright Red Orange	Quart	\$131.49	E0-2689000
2G8003G	(G8003/1GLUS)	Matterhorn White	Gallon	\$253.49	E0-2109100
2G8003Q	(G8003/1QTUS)	Matterhorn White	Quart	\$91.69	E0-7786000
2G8004G	(G8004/1GLUS)	Vestal White	Gallon	\$253.49	E0-2109100
2G8004Q	(G8004/1QTUS)	Vestal White	Quart	\$91.69	E0-7786000
2G8009G	(G8009/1GLUS)	Off-White Revisited	Gallon	\$253.49	E0-2109100
2G8009Q	(G8009/1QTUS)	Off-White Revisited	Quart	\$91.69	E0-7786000
2G8010G	(G8010/1GLUS)	Off White	Gallon	\$253.49	E0-2109100
2G8010Q	(G8010/1QTUS)	Off White	Quart	\$91.69	E0-7786000
2G8022G	(G8022/1GLUS)	Insignia White	Gallon	\$253.49	E0-2109100
2G8022Q	(G8022/1QTUS)	Insignia White	Quart	\$91.69	E0-7786000
2G8035G	(G8035/1GLUS)	Whisper Gray	Gallon	\$253.49	E0-2109100
2G8035Q	(G8035/1QTUS)	Whisper Gray	Quart	\$99.19	E0-9347000
2G8044G	(G8044/1GLUS)	Snow White	Gallon	\$253.49	E0-2109100
2G8044Q	(G8044/1QTUS)	Snow White	Quart	\$91.69	E0-7786000
2G8089G	(G8089/1GLUS)	Cloud White	Gallon	\$253.49	E0-2109100
2G8089Q	(G8089/1QTUS)	Cloud White	Quart	\$91.69	E0-7786000
2G8212G	(G8212/1GLUS)	Blue Tone White	Gallon	\$253.49	E0-2109100
2G8212Q	(G8212/1QTUS)	Blue Tone White	Quart	\$91.69	E0-7786000
2G9001G	(G9001/1GLUS)	San Mateo Wheat	Gallon	\$275.79	E0-4860200
2G9001Q	(G9001/1QTUS)	San Mateo Wheat	Quart	\$99.19	E0-9347000
2G9093G	(G9093/1GLUS)	Fighting Lady Yellow	Gallon	\$324.49	E0-7334200
2G9093Q	(G9093/1QTUS)	Fighting Lady Yellow	Quart	\$118.69	E0-2098000
2G9298G	(G9298/1GLUS)	Federal Yellow	Gallon	\$372.79	E0-9597200
2G9298Q	(G9298/1QTUS)	Federal Yellow	Quart	\$123.69	E0-7729000
2G9455G	(G9455/1GLUS)	Citrus	Gallon	\$324.49	E0-7334200
2G9455Q	(G9455/1QTUS)	Citrus	Quart	\$118.69	E0-2098000
2H1021G	(H1021/1GLUS)	Bright Aluminum	Gallon	\$372.79	E0-9597200
2H1021Q	(H1021/1QTUS)	Bright Aluminum	Quart	\$118.69	E0-2098000
2H1048G	(H1048/1GLUS)	Silver	Gallon	\$372.79	E0-9597200
2H1048Q	(H1048/1QTUS)	Silver	Quart	\$118.69	E0-2098000
2H1303G	(H1303/1GLUS)	Medium Silver	Gallon	\$372.79	E0-9597200
2H1303Q	(H1303/1QTUS)	Medium Silver	Quart	\$118.69	E0-2098000
2H1305G	(H1305/1GLUS)	Haze Gray	Gallon	\$253.49	E0-2109100
2H1305Q	(H1305/1QTUS)	Haze Gray	Quart	\$99.19	E0-9347000
2H1313G	(H1313/1GLUS)	Seattle Gray	Gallon	\$253.49	E0-2109100
2H1313Q	(H1313/1QTUS)	Seattle Gray	Quart	\$99.19	E0-9347000
2H1315G	(H1315/1GLUS)	Anthracite Gray	Gallon	\$253.49	E0-2109100
2H1315Q	(H1315/1QTUS)	Anthracite Gray	Quart	\$99.19	E0-9347000
2H4024G	(H4024/1GLUS)	Dark Green	Gallon	\$324.49	E0-7334200
2H4024Q	(H4024/1QTUS)	Dark Green	Quart	\$118.69	E0-2098000
2H4089G	(H4089/1GLUS)	Jade Mist Green	Gallon	\$324.49	E0-7334200
2H4089Q	(H4089/1QTUS)	Jade Mist Green	Quart	\$118.69	E0-2098000
2H4094G	(H4094/1GLUS)	Forest Green	Gallon	\$324.49	E0-7334200
2H4094Q	(H4094/1QTUS)	Forest Green	Quart	\$118.69	E0-2098000
2H4256G	(H4256/1GLUS)	Sea Foam	Gallon	\$324.49	E0-7334200
2H4256Q	(H4256/1QTUS)	Sea Foam	Quart	\$118.69	E0-2098000
2H4264G	(H4264/1GLUS)	Brightside Teal	Gallon	\$324.49	E0-7334200
2H4264Q	(H4264/1QTUS)	Brightside Teal	Quart	\$118.69	E0-2098000
2H4302G	(H4302/1GLUS)	Kelly Green	Gallon	\$324.49	E0-7334200
2H4302Q	(H4302/1QTUS)	Kelly Green	Quart	\$118.69	E0-2098000
2H4365G	(H4365/1GLUS)	Aqua Mist	Gallon	\$324.49	E0-7334200
2H4365Q	(H4365/1QTUS)	Aqua Mist	Quart	\$118.69	E0-2098000
2H4413G	(H4413/1GLUS)	Timeless Green	Gallon	\$324.49	E0-7334200
2H4413Q	(H4413/1QTUS)	Timeless Green	Quart	\$118.69	E0-2098000
2H4459G	(H4459/1GLUS)	Sea Green	Gallon	\$324.49	E0-7334200

AWLGRIP® Awlmix® Color Matching System - Awlgrip® Colors



Order No.	Mfg. No.	Color	Size	List Price	
2H5346G	(H5346/1GLUS)	Midnight Blue	Gallon	\$297.79	EO-4332200
2H5346Q	(H5346/1QTUS)	Midnight Blue	Quart	\$106.49	EO-7897000
2H5409G	(H5409/1GLUS)	Majestic Blue	Gallon	\$297.79	EO-4332200
2H5409Q	(H5409/1QTUS)	Majestic Blue	Quart	\$106.49	EO-7897000
2H5462G	(H5462/1GLUS)	Boston Whaler Blue	Gallon	\$297.79	EO-4332200
2H5462Q	(H5462/1QTUS)	Boston Whaler Blue	Quart	\$106.49	EO-7897000
2H5511G	(H5511/1GLUS)	Pigeon Blue	Gallon	\$290.69	EO-2081200
2H5511Q	(H5511/1QTUS)	Pigeon Blue	Quart	\$106.49	EO-7897000
2H5524G	(H5524/1GLUS)	Dark Blue	Gallon	\$297.79	EO-4332200
2H5524Q	(H5524/1QTUS)	Dark Blue	Quart	\$106.49	EO-7897000
2H5543G	(H5543/1GLUS)	Lauderdale Blue	Gallon	\$297.79	EO-4332200
2H5545G	(H5545/1GLUS)	Ocean Blue	Gallon	\$297.79	EO-4332200
2H5545Q	(H5545/1QTUS)	Ocean Blue	Quart	\$106.49	EO-7897000
2H5566G	(H5566/1GLUS)	Atlantic Blue	Gallon	\$297.79	EO-4332200
2H5566Q	(H5566/1QTUS)	Atlantic Blue	Quart	\$106.49	EO-7897000
2H5570G	(H5570/1GLUS)	Light Blue	Gallon	\$297.79	EO-4332200
2H5570Q	(H5570/1QTUS)	Light Blue	Quart	\$106.49	EO-7897000
2H5615G	(H5615/1GLUS)	Mauritius Blue	Gallon	\$297.79	EO-4332200
2H5615Q	(H5615/1QTUS)	Mauritius Blue	Quart	\$106.49	EO-7897000
2H5627G	(H5627/1GLUS)	Petrol Blue	Gallon	\$297.79	EO-4332200
2H5627Q	(H5627/1QTUS)	Petrol Blue	Quart	\$106.49	EO-7897000
2H5723G	(H5723/1GLUS)	Island Turquoise	Gallon	\$297.79	EO-4332200
2H5723Q	(H5723/1QTUS)	Island Turquoise	Quart	\$106.49	EO-7897000
2H5732G	(H5732/1GLUS)	Largo Blue	Gallon	\$297.79	EO-4332200
2H5732Q	(H5732/1QTUS)	Largo Blue	Quart	\$106.49	EO-7897000
2H6160G	(H6160/1GLUS)	Desert Sand	Gallon	\$275.79	EO-4860200
2H6160Q	(H6160/1QTUS)	Desert Sand	Quart	\$99.19	EO-9347000
2H6421G	(H6421/1GLUS)	Grand Banks Beige	Gallon	\$275.79	EO-4860200
2H6421Q	(H6421/1QTUS)	Grand Banks Beige	Quart	\$99.19	EO-9347000
2H6440G	(H6440/1GLUS)	Bristol Beige	Gallon	\$275.79	EO-4860200
2H6440Q	(H6440/1QTUS)	Bristol Beige	Quart	\$99.19	EO-9347000
2H6443G	(H6443/1GLUS)	Horizons Teak	Gallon	\$275.79	EO-4860200
2H6443Q	(H6443/1QTUS)	Horizons Teak	Quart	\$99.19	EO-9347000
2H6462G	(H6462/1GLUS)	Catboat Tan	Gallon	\$275.79	EO-4860200
2H6462Q	(H6462/1QTUS)	Catboat Tan	Quart	\$99.19	EO-9347000
2H6520G	(H6520/1GLUS)	Desert Tan	Gallon	\$275.79	EO-4860200
2H6520Q	(H6520/1QTUS)	Desert Tan	Quart	\$99.19	EO-9347000
2H6523G	(H6523/1GLUS)	Grand Banks Beige 4217	Gallon	\$275.79	EO-4860200
2H6523Q	(H6523/1QTUS)	Grand Banks Beige 4217	Quart	\$99.19	EO-9347000
2H7161G	(H7161/1GLUS)	Toreador Red	Gallon	\$372.79	EO-9597200
2H7161Q	(H7161/1QTUS)	Toreador Red	Quart	\$131.49	EO-2689000
2H7268G	(H7268/1GLUS)	Hot Pink	Gallon	\$372.79	EO-9597200
2H7268Q	(H7268/1QTUS)	Hot Pink	Quart	\$131.49	EO-2689000
2H7425G	(H7425/1GLUS)	Cabernet Burgundy	Gallon	\$372.79	EO-9597200
2H7425Q	(H7425/1QTUS)	Cabernet Burgundy	Quart	\$131.49	EO-2689000
2H7426G	(H7426/1GLUS)	Rochelle Red	Gallon	\$372.79	EO-9597200
2H7426Q	(H7426/1QTUS)	Rochelle Red	Quart	\$131.49	EO-2689000
2H7550G	(H7550/1GLUS)	Soft Pink	Gallon	\$372.79	EO-9597200
2H7550Q	(H7550/1QTUS)	Soft Pink	Quart	\$131.49	EO-2689000
2H8002G	(H8002/1GLUS)	Cream	Gallon	\$253.49	EO-2109100
2H8002Q	(H8002/1QTUS)	Cream	Quart	\$91.69	EO-7786000
2H8015G	(H8015/1GLUS)	Egg Shell White	Gallon	\$253.49	EO-2109100
2H8015Q	(H8015/1QTUS)	Egg Shell White	Quart	\$91.69	EO-7786000
2H8086G	(H8086/1GLUS)	Chevy White	Gallon	\$253.49	EO-2109100
2H8086Q	(H8086/1QTUS)	Chevy White	Quart	\$91.69	EO-7786000
2H4459Q	(H4459/1QTUS)	Sea Green	Quart	\$118.69	EO-2098000
2H4492G	(H4492/1GLUS)	Donegal Green	Gallon	\$324.49	EO-7334200
2H4492Q	(H4492/1QTUS)	Donegal Green	Quart	\$118.69	EO-2098000
2H4661G	(H4661/1GLUS)	Lime	Gallon	\$324.49	EO-7334200
2H4661Q	(H4661/1QTUS)	Lime	Quart	\$118.69	EO-2098000
2H4691G	(H4691/1GLUS)	Citrus Green	Gallon	\$324.49	EO-7334200

Order No.	Mfg. No.	Color	Size	List Price	
2H4691Q	(H4691/1QTUS)	Citrus Green	Quart	\$118.69	EO-2098000
2H5004G	(H5004/1GLUS)	Ice Blue	Gallon	\$297.79	EO-4332200
2H5004Q	(H5004/1QTUS)	Ice Blue	Quart	\$106.49	EO-7897000
2H5161G	(H5161/1GLUS)	Stars & Stripes Blue	Gallon	\$297.79	EO-4332200
2H5161Q	(H5161/1QTUS)	Stars & Stripes Blue	Quart	\$106.49	EO-7897000
2H5328G	(H5328/1GLUS)	Teal	Gallon	\$297.79	EO-4332200
2H5328Q	(H5328/1QTUS)	Teal	Quart	\$106.49	EO-7897000
2H5342G	(H5342/1GLUS)	Carinthla Blue	Gallon	\$297.79	EO-4332200
2H5342Q	(H5342/1QTUS)	Carinthla Blue	Quart	\$106.49	EO-7897000
2H8087G	(H8087/1GLUS)	Fleet White	Gallon	\$253.49	EO-2109100
2H8087Q	(H8087/1QTUS)	Fleet White	Quart	\$91.69	EO-7786000
2H8139G	(H8139/1GLUS)	Oyster White	Gallon	\$253.49	EO-2109100
2H8139Q	(H8139/1QTUS)	Oyster White	Quart	\$91.69	EO-7786000
2H8208G	(H8208/1GLUS)	Stark White	Gallon	\$253.49	EO-2109100
2H8208Q	(H8208/1QTUS)	Stark White	Quart	\$91.69	EO-7786000
2H8337G	(H8337/1GLUS)	Chalky White	Gallon	\$253.49	EO-2109100
2H8337Q	(H8337/1QTUS)	Chalky White	Quart	\$91.69	EO-7786000
2H8386G	(H8386/1GLUS)	Signal White	Gallon	\$253.49	EO-2109100
2H8386Q	(H8386/1QTUS)	Signal White	Quart	\$91.69	EO-7786000
2H8403G	(H8403/1GLUS)	Blanc Pur	Gallon	\$253.49	EO-2109100
2H8403Q	(H8403/1QTUS)	Blanc Pur	Quart	\$91.69	EO-7786000
2H8413G	(H8413/1GLUS)	Lunar White	Gallon	\$253.49	EO-2109100
2H8413Q	(H8413/1QTUS)	Lunar White	Quart	\$91.69	EO-7786000
2H8414G	(H8414/1GLUS)	Hatteras Off-White	Gallon	\$253.49	EO-2109100
2H8414Q	(H8414/1QTUS)	Hatteras Off-White	Quart	\$91.69	EO-7786000
2H8424G	(H8424/1GLUS)	Nordic White	Gallon	\$253.49	EO-2109100
2H8424Q	(H8424/1QTUS)	Nordic White	Quart	\$91.69	EO-7786000
2H8427G	(H8427/1GLUS)	Silver White	Gallon	\$253.49	EO-2109100
2H8427Q	(H8427/1QTUS)	Silver White	Quart	\$91.69	EO-7786000
2H8428G	(H8428/1GLUS)	Sand White	Gallon	\$253.49	EO-2109100
2H8428Q	(H8428/1QTUS)	Sand White	Quart	\$91.69	EO-7786000
2H8429G	(H8429/1GLUS)	Vanilla White	Gallon	\$253.49	EO-2109100
2H8429Q	(H8429/1QTUS)	Vanilla White	Quart	\$91.69	EO-7786000
2H8430G	(H8430/1GLUS)	Clipper White	Gallon	\$253.49	EO-2109100
2H8430Q	(H8430/1QTUS)	Clipper White	Quart	\$91.69	EO-7786000
2H8431G	(H8431/1GLUS)	Snow White Revisited	Gallon	\$253.49	EO-2109100
2H8431Q	(H8431/1QTUS)	Snow White Revisited	Quart	\$91.69	EO-7786000
2H8435G	(H8435/1GLUS)	Biscuit	Gallon	\$253.49	EO-2109100
2H8435Q	(H8435/1QTUS)	Biscuit	Quart	\$91.69	EO-7786000
2H8464G	(H8464/1GLUS)	Bertram White	Gallon	\$253.49	EO-2109100
2H8464Q	(H8464/1QTUS)	Bertram White	Quart	\$91.69	EO-7786000
2H8477G	(H8477/1GLUS)	Blue Glo White	Gallon	\$253.49	EO-2109100
2H8477Q	(H8477/1QTUS)	Blue Glo White	Quart	\$91.69	EO-7786000
2H8479G	(H8479/1GLUS)	Brightside Off-White	Gallon	\$253.49	EO-2109100
2H8479Q	(H8479/1QTUS)	Brightside Off-White	Quart	\$91.69	EO-7786000
2H8493G	(H8493/1GLUS)	Light Ivory	Gallon	\$253.49	EO-2109100
2H8493Q	(H8493/1QTUS)	Light Ivory	Quart	\$91.69	EO-7786000
2H8646G	(H8646/1GLUS)	Hatteras Off-White 4208	Gallon	\$253.49	EO-2109100
2H8646Q	(H8646/1QTUS)	Hatteras Off-White 4208	Quart	\$91.69	EO-7786000
2H8647G	(H8647/1GLUS)	Morrisville Double	Gallon	\$253.49	EO-2109100
2H8647Q	(H8647/1QTUS)	Morrisville Double	Quart	\$91.69	EO-7786000
2H9178Q	(H9178/1QTUS)	Cordovan Gold	Quart	\$193.79	EO-4354100
2H9182Q	(H9182/1QTUS)	Pale Gold	Quart	\$193.79	EO-4354100
2H9202G	(H9202/1GLUS)	Vermillion	Gallon	\$372.79	EO-9597200
2H9202Q	(H9202/1QTUS)	Vermillion	Quart	\$131.49	EO-2689000
2H9256G	(H9256/1GLUS)	Yellow	Gallon	\$372.79	EO-9597200
2H9256Q	(H9256/1QTUS)	Yellow	Quart	\$123.69	EO-7729000
2H9258G	(H9258/1GLUS)	Saffron Yellow	Gallon	\$372.79	EO-9597200
2H9258Q	(H9258/1QTUS)	Saffron Yellow	Quart	\$123.69	EO-7729000
2H9265G	(H9265/1GLUS)	Lemon Yellow	Gallon	\$372.79	EO-9597200
2H9265Q	(H9265/1QTUS)	Lemon Yellow	Quart	\$123.69	EO-7729000

Paint & Paint Acc.

- Electronics
- Trolling Motors
- Instruments
- Electrical
- Lighting
- Anchor & Dock
- Safety
- Steering, Controls
- Pumps
- Fuel System
- Seating & Pedestals
- Trailering
- Tops & Covers
- Perform.
- Propellers
- Engine & Care
- Cleaning & Care
- Paint & Paint Acc.
- Fun & Flotation
- Topside Acc.
- Cockpit & Deck
- Hardware, Fasteners
- Camouflage
- Misc.
- Comm.



**AWLGRIP® Awlmix® Color Matching System - Awlcraft® SE Colors**

- Electronics
- Trolling Motors
- Instruments
- Electrical
- Lighting
- Anchor & Dock
- Safety
- Steering, Controls
- Pumps
- Fuel System
- Seating & Pedestals
- Trailer
- Tops & Covers
- Perform.
- Propellers
- Engine & Care
- Cleaning & Care
- Paint & Paint Acc.
- Fun & Flotation
- Topside Acc.
- Cockpit & Deck
- Hardware, Fasteners
- Camouflage
- Misc.
- Comm.

Order No.	Mfg. No.	Color	Size	List Price	
2L6001G	(L6001/1GLUS)	Sable Brown	Gallon	\$468.19	EO-4115300
2L6001Q	(L6001/1QTUS)	Sable Brown	Quart	\$213.39	EO-4006100
2L6002G	(L6002/1GLUS)	Prairie Beige	Gallon	\$468.19	EO-4115300
2L6002Q	(L6002/1QTUS)	Prairie Beige	Quart	\$213.39	EO-4006100
2L6003G	(L6003/1GLUS)	Moon Dust	Gallon	\$468.19	EO-4115300
2L6003Q	(L6003/1QTUS)	Moon Dust	Quart	\$213.39	EO-4006100
2L6004G	(L6004/1GLUS)	Castle Tan	Gallon	\$468.19	EO-4115300
2L6004Q	(L6004/1QTUS)	Castle Tan	Quart	\$213.39	EO-4006100
2L6005G	(L6005/1GLUS)	Sahara Tan	Gallon	\$468.19	EO-4115300
2L6005Q	(L6005/1QTUS)	Sahara Tan	Quart	\$213.39	EO-4006100
2L6006G	(L6006/1GLUS)	Mocha	Gallon	\$468.19	EO-4115300
2L6006Q	(L6006/1QTUS)	Mocha	Quart	\$213.39	EO-4006100
2L6007G	(L6007/1GLUS)	Desert Sand	Gallon	\$468.19	EO-4115300
2L6007Q	(L6007/1QTUS)	Desert Sand	Quart	\$213.39	EO-4006100
2L6008G	(L6008/1GLUS)	Grand Banks Beige	Gallon	\$468.19	EO-4115300
2L6008Q	(L6008/1QTUS)	Grand Banks Beige	Quart	\$213.39	EO-4006100
2L6009G	(L6009/1GLUS)	Bristol Beige	Gallon	\$468.19	EO-4115300
2L6009Q	(L6009/1QTUS)	Bristol Beige	Quart	\$213.39	EO-4006100
2L6010G	(L6010/1GLUS)	Horizons Teak	Gallon	\$468.19	EO-4115300
2L6010Q	(L6010/1QTUS)	Horizons Teak	Quart	\$213.39	EO-4006100
2L6011G	(L6011/1GLUS)	Catboat Tan	Gallon	\$468.19	EO-4115300
2L6011Q	(L6011/1QTUS)	Catboat Tan	Quart	\$213.39	EO-4006100
2L6012G	(L6012/1GLUS)	Desert Tan	Gallon	\$468.19	EO-4115300
2L6012Q	(L6012/1QTUS)	Desert Tan	Quart	\$213.39	EO-4006100
2L6013G	(L6013/1GLUS)	Grand Banks Beige 4217	Gallon	\$468.19	EO-4115300
2L6013Q	(L6013/1QTUS)	Grand Banks Beige 4217	Quart	\$213.39	EO-4006100
2L7001G	(L7001/1GLUS)	Red Mahogany	Gallon	\$616.69	EO-2526400
2L7001Q	(L7001/1QTUS)	Red Mahogany	Quart	\$212.79	EO-9595100
2L7002G	(L7002/1GLUS)	Sunfast Red	Gallon	\$616.69	EO-2526400
2L7002Q	(L7002/1QTUS)	Sunfast Red	Quart	\$212.79	EO-9595100
2L7003G	(L7003/1GLUS)	Claret	Gallon	\$616.69	EO-2526400
2L7003Q	(L7003/1QTUS)	Claret	Quart	\$212.79	EO-9595100
2L7004G	(L7004/1GLUS)	International Orange	Gallon	\$616.69	EO-2526400
2L7004Q	(L7004/1QTUS)	International Orange	Quart	\$212.79	EO-9595100
2L7005G	(L7005/1GLUS)	Vivid Red	Gallon	\$616.69	EO-2526400
2L7005Q	(L7005/1QTUS)	Vivid Red	Quart	\$212.79	EO-9595100
2L7006G	(L7006/1GLUS)	Sarafsa Red	Gallon	\$616.69	EO-2526400
2L7006Q	(L7006/1QTUS)	Sarafsa Red	Quart	\$212.79	EO-9595100
2L7007G	(L7007/1GLUS)	Bright Red Orange	Gallon	\$616.69	EO-2526400
2L7007Q	(L7007/1QTUS)	Bright Red Orange	Quart	\$212.79	EO-9595100
2L7008G	(L7008/1GLUS)	Toreador Red	Gallon	\$616.69	EO-2526400
2L7008Q	(L7008/1QTUS)	Toreador Red	Quart	\$212.79	EO-9595100
2L7009G	(L7009/1GLUS)	Hot Pink	Gallon	\$616.69	EO-2526400
2L7009Q	(L7009/1QTUS)	Hot Pink	Quart	\$212.79	EO-9595100
2L7010G	(L7010/1GLUS)	Cabernet Burgundy	Gallon	\$616.69	EO-2526400
2L7010Q	(L7010/1QTUS)	Cabernet Burgundy	Quart	\$212.79	EO-9595100
2L7011G	(L7011/1GLUS)	Rochelle Red	Gallon	\$616.69	EO-2526400
2L7011Q	(L7011/1QTUS)	Rochelle Red	Quart	\$212.79	EO-9595100
2L7012G	(L7012/1GLUS)	Soft Pink	Gallon	\$616.69	EO-2526400
2L7012Q	(L7012/1QTUS)	Soft Pink	Quart	\$212.79	EO-9595100
2L8001G	(L8001/1GLUS)	Matterhorn White	Gallon	\$446.89	EO-7153300
2L8001Q	(L8001/1QTUS)	Matterhorn White	Quart	\$156.89	EO-7671100
2L8002G	(L8002/1GLUS)	Vestal White	Gallon	\$446.89	EO-7153300
2L8002Q	(L8002/1QTUS)	Vestal White	Quart	\$156.89	EO-7671100
2L8003G	(L8003/1GLUS)	Off-White Revisited	Gallon	\$446.89	EO-7153300
2L8003Q	(L8003/1QTUS)	Off-White Revisited	Quart	\$156.89	EO-7671100
2L8004G	(L8004/1GLUS)	Off White	Gallon	\$446.89	EO-7153300
2L8004Q	(L8004/1QTUS)	Off White	Quart	\$156.89	EO-7671100
2L8005G	(L8005/1GLUS)	Insignia White	Gallon	\$446.89	EO-7153300
2L8005Q	(L8005/1QTUS)	Insignia White	Quart	\$156.89	EO-7671100
2L8006G	(L8006/1GLUS)	Whisper Gray	Gallon	\$446.89	EO-7153300
2L8006Q	(L8006/1QTUS)	Whisper Gray	Quart	\$156.89	EO-7671100
2L8007G	(L8007/1GLUS)	Snow White	Gallon	\$446.89	EO-7153300
2L8007Q	(L8007/1QTUS)	Snow White	Quart	\$156.89	EO-7671100
2L8008G	(L8008/1GLUS)	Cloud White	Gallon	\$446.89	EO-7153300
2L8008Q	(L8008/1QTUS)	Cloud White	Quart	\$156.89	EO-7671100
2L8009G	(L8009/1GLUS)	Blue Tone White	Gallon	\$446.89	EO-7153300

Order No.	Mfg. No.	Color	Size	List Price	
2L8009Q	(L8009/1QTUS)	Blue Tone White	Quart	\$156.89	EO-7671100
2L8010G	(L8010/1GLUS)	Cream	Gallon	\$446.89	EO-7153300
2L8010Q	(L8010/1QTUS)	Cream	Quart	\$156.89	EO-7671100
2L8011G	(L8011/1GLUS)	Egg Shell White	Gallon	\$446.89	EO-7153300
2L8011Q	(L8011/1QTUS)	Egg Shell White	Quart	\$156.89	EO-7671100
2L8012G	(L8012/1GLUS)	Chevy White	Gallon	\$446.89	EO-7153300
2L8012Q	(L8012/1QTUS)	Chevy White	Quart	\$156.89	EO-7671100
2L8013G	(L8013/1GLUS)	Fleet White	Gallon	\$446.89	EO-7153300
2L8013Q	(L8013/1QTUS)	Fleet White	Quart	\$156.89	EO-7671100
2L8014G	(L8014/1GLUS)	Oyster White	Gallon	\$446.89	EO-7153300
2L8014Q	(L8014/1QTUS)	Oyster White	Quart	\$156.89	EO-7671100
2L8015G	(L8015/1GLUS)	Stark White	Gallon	\$446.89	EO-7153300
2L8015Q	(L8015/1QTUS)	Stark White	Quart	\$156.89	EO-7671100
2L8016G	(L8016/1GLUS)	Chalky White	Gallon	\$446.89	EO-7153300
2L8016Q	(L8016/1QTUS)	Chalky White	Quart	\$156.89	EO-7671100
2L8017G	(L8017/1GLUS)	Signal White	Gallon	\$439.79	EO-4892300
2L8017Q	(L8017/1QTUS)	Signal White	Quart	\$156.89	EO-7671100
2L8018G	(L8018/1GLUS)	Blanc Pur	Gallon	\$446.89	EO-7153300
2L8018Q	(L8018/1QTUS)	Blanc Pur	Quart	\$156.89	EO-7671100
2L8019G	(L8019/1GLUS)	Lunar White	Gallon	\$446.89	EO-7153300
2L8019Q	(L8019/1QTUS)	Lunar White	Quart	\$156.89	EO-7671100
2L8020G	(L8020/1GLUS)	Hatteras Off-White	Gallon	\$446.89	EO-7153300
2L8020Q	(L8020/1QTUS)	Hatteras Off-White	Quart	\$156.89	EO-7671100
2L8021G	(L8021/1GLUS)	Nordic White	Gallon	\$446.89	EO-7153300
2L8021Q	(L8021/1QTUS)	Nordic White	Quart	\$156.89	EO-7671100
2L8022G	(L8022/1GLUS)	Silver White	Gallon	\$446.89	EO-7153300
2L8022Q	(L8022/1QTUS)	Silver White	Quart	\$156.89	EO-7671100
2L8023G	(L8023/1GLUS)	Sand White	Gallon	\$446.89	EO-7153300
2L8023Q	(L8023/1QTUS)	Sand White	Quart	\$156.89	EO-7671100
2L8024G	(L8024/1GLUS)	Vanilla White	Gallon	\$446.89	EO-7153300
2L8024Q	(L8024/1QTUS)	Vanilla White	Quart	\$156.89	EO-7671100
2L8025G	(L8025/1GLUS)	Clipper White	Gallon	\$446.89	EO-7153300
2L8025Q	(L8025/1QTUS)	Clipper White	Quart	\$156.89	EO-7671100
2L8026G	(L8026/1GLUS)	Snow White Revisited	Gallon	\$446.89	EO-7153300
2L8026Q	(L8026/1QTUS)	Snow White Revisited	Quart	\$156.89	EO-7671100
2L8027G	(L8027/1GLUS)	Biscuit	Gallon	\$468.19	EO-4115300
2L8027Q	(L8027/1QTUS)	Biscuit	Quart	\$213.39	EO-4006100
2L8028G	(L8028/1GLUS)	Bertram White	Gallon	\$446.89	EO-7153300
2L8028Q	(L8028/1QTUS)	Bertram White	Quart	\$156.89	EO-7671100
2L8029G	(L8029/1GLUS)	Blue Glo White	Gallon	\$446.89	EO-7153300
2L8029Q	(L8029/1QTUS)	Blue Glo White	Quart	\$156.89	EO-7671100
2L8030G	(L8030/1GLUS)	Brightside Off-White	Gallon	\$446.89	EO-7153300
2L8030Q	(L8030/1QTUS)	Brightside Off-White	Quart	\$156.89	EO-7671100
2L8031G	(L8031/1GLUS)	Light Ivory	Gallon	\$446.89	EO-7153300
2L8031Q	(L8031/1QTUS)	Light Ivory	Quart	\$156.89	EO-7671100
2L8032G	(L8032/1GLUS)	Hatteras Off-White 4208	Gallon	\$446.89	EO-7153300
2L8032Q	(L8032/1QTUS)	Hatteras Off-White 4208	Quart	\$156.89	EO-7671100
2L8033G	(L8033/1GLUS)	Morrinsville Double	Gallon	\$446.89	EO-7153300
2L8033Q	(L8033/1QTUS)	Morrinsville Double	Quart	\$156.89	EO-7671100
2L9001G	(L9001/1GLUS)	San Mateo Wheat	Gallon	\$468.19	EO-4115300
2L9001Q	(L9001/1QTUS)	San Mateo Wheat	Quart	\$213.39	EO-4006100
2L9002G	(L9002/1GLUS)	Fighting Lady Yellow	Gallon	\$468.19	EO-4115300
2L9002Q	(L9002/1QTUS)	Fighting Lady Yellow	Quart	\$213.39	EO-4006100
2L9003G	(L9003/1GLUS)	Federal Yellow	Gallon	\$468.19	EO-4115300
2L9003Q	(L9003/1QTUS)	Federal Yellow	Quart	\$213.39	EO-4006100
2L9004G	(L9004/1GLUS)	Citrus	Gallon	\$519.09	EO-2398300
2L9004Q	(L9004/1QTUS)	Citrus	Quart	\$212.79	EO-9595100
2L9005G	(L9005/1GLUS)	Vermillion	Gallon	\$616.69	EO-2526400
2L9005Q	(L9005/1QTUS)	Vermillion	Quart	\$212.79	EO-9595100
2L9006G	(L9006/1GLUS)	Yellow	Gallon	\$468.19	EO-4115300
2L9006Q	(L9006/1QTUS)	Yellow	Quart	\$213.39	EO-4006100
2L9007G	(L9007/1GLUS)	Saffron Yellow	Gallon	\$468.19	EO-4115300
2L9007Q	(L9007/1QTUS)	Saffron Yellow	Quart	\$213.39	EO-4006100
2L9008G	(L9008/1GLUS)	Lemon Yellow	Gallon	\$468.19	EO-4115300
2L9008Q	(L9008/1QTUS)	Lemon Yellow	Quart	\$213.39	EO-4006100
2Q7055G	(Q7055/1GLUS)	Transoxide Red	Gallon	\$399.49	EO-2699200
2Q9030G	(Q9030/1GLUS)	Transoxide Yellow	Gallon	\$399.49	EO-2699200



**AWLGRIP® Quick Build Surfacer**



- A high performance yacht priming system, formulated to provide a quick and convenient application.
- Using just six colored primers, Quick Build can closely match any finish, reducing the number of stages required to produce outstanding results.
- Can be applied directly to certain substrates with no other primers required.
- Easy application system for preparation and application in a single day.
- Vibrant colors in just minutes, closely matching finish colors for quicker hide.

Order No.	Mfg. No. / Description	List Price
511306	(U2000/1GLUS) Black Base Gallon	\$245.39 E0-4048100
511445	(U8000/1GLUS) White Base Gallon	\$245.39 E0-4048100
511712	(U3100/1QTUS) Sealer Converter Quart	\$76.19 E0-4175000
511736	(U3200/1QTUS) Surface Converter Quart	\$76.19 E0-4175000
511801	(A3110/1GLUS) Sealer Activator Gallon	\$145.29 E0-7980100
511837	(A3210/1QTSU) Surface Activator Quart	\$51.29 E0-7483000

**AWLGRIP® 545 Epoxy Primer**



- A multi-use, corrosion-resistant epoxy primer used to seal undercoats and surfacing primers before applying finishes.
- Can be applied both above and below the waterline on a wide range of substrates, via spray or brush and roller.
- Dual purpose; seals both undercoats and surfacing primers in a single product.
- Outstanding corrosion protection, increasing the longevity of your system.
- Excellent adhesion to all substrates.

Order No.	Mfg. No. / Description	List Price
508260	(D1001/1GLUS) Gray Base Gallon	\$118.79 E0-9098000
508272	(D1001/1QTUS) Gray Base Quart	\$41.09 E0-2803000
508486	(D8001/1GLUS) White Base Gallon	\$118.49 E0-7888000
508498	(D8001/1QTUS) White Base Quart	\$39.59 E0-9692000
508323	(D3001/1GLUS) Converter Gallon	\$111.59 E0-9638000
508335	(D3001/1QTUS) Converter Quart	\$37.49 E0-2182000

**AWLGRIP® Cold Cure Accelerator**

- Cold Cure is an accelerator used with 545 Epoxy Primer, reducing cure and recoat times by up to 50%.
- Can be added up to 12.5% of catalyzed volume to 545, replacing the standard reducer.
- Ideal for speeding up cure rate in cooler temperatures.
- Tailored for use between 10° C/50° F and 24° C/75° F.
- Suitable for use with brush and roller or spray application.

Order No.	Mfg. No. / Description	List Price
510722	(M3066/1PTUS) Pint	\$25.49 E0-2191000

**AWLGRIP® Max Cor CF High Solids Primer**



- Max Cor CF is a two-component high solid epoxy primer, tailored to provide aluminum and steel with excellent chemical and solvent resistance.
- A chromate-free product with innovative Controlled Fusion (CF) technology for extended re-coat times, improved substrate adhesion and reduced sanding.
- Contains anti-corrosive pigments to extend system longevity.
- Great adhesion to aluminum and steel.
- Can be directly overcoated with Hullgard Extra.

Order No.	Mfg. No. / Description	List Price
508410	(R4330/1GLUS) Base Gallon	\$267.09 E0-2300200
508395	(R3330/1HGUS) Converter 1/2 Gallon	\$95.39 E0-4517000

**AWLGRIP® High Build Epoxy Primer**



- An epoxy surfacing primer, used where high build and filling is required above the waterline.
- Ideal for use over Awlgrip primers and fairing compounds, can also be applied directly to pre-prepared wood or fiberglass.
- Prevents solvent leaching.
- Compatible with Awlgrip primers and direct application.
- Can be used with specialized converter and reducer for US VOC compliance.

Order No.	Mfg. No. / Description	List Price
508501	(D8002/1GLUS) Off-White Base Gallon	\$126.59 E0-4949000
508513	(D8002/1QTUS) Off-White Base Quart	\$42.29 E0-2713000
508652	(D9002/1GLUS) Yellow Base Gallon	\$126.59 E0-4949000
508664	(D9002/1QTUS) Yellow Base Quart	\$44.59 E0-4433000
508347	(D3002/1GLUS) Converter Gallon	\$127.19 E0-9359000
508359	(D3002/1QTUS) Converter Quart	\$43.59 E0-9623000

**SPECIAL HANDLING MAY APPLY**

- Electronics
- Trolling Motors
- Instruments
- Electrical
- Lighting
- Anchor & Dock
- Safety
- Steering, Controls
- Pumps
- Fuel System
- Seating & Pedestals
- Trailing
- Tops & Covers
- Perform.
- Propellers
- Engine & Care
- Cleaning & Care
- Paint & Paint Acc.
- Fun & Flotation
- Topside Acc.
- Cockpit & Deck
- Hardware, Fasteners
- Camouflage
- Misc.
- Comm.

**AWLGRIP® Awlquik Epoxy Primer**



- A two-component quick-drying epoxy primer/surfacer, for application above the waterline by brush and roller or spray.
- Provides a medium build and is easily sanded.
- Easy to apply by brush and roller or spray.
- Quick-drying for a faster application process.
- Easy to sand, allowing the next layer to be applied sooner.

Order No.	Mfg. No. / Description		List Price	
508525	(D8003/1GLUS) Off-White Base	Gallon	\$142.49	E0-7860100
508537	(D8003/1QTUS) Off-White Base	Quart	\$50.09	E0-7573000
508638	(D9001/1GLUS) Converter	Gallon	\$143.99	E0-9970100
508640	(D9001/1QTUS) Converter	Quart	\$50.69	E0-2083000

**AWLGRIP® Wash Primer CF**



- A chromate-free etch primer that incorporates Controlled Fusion (CF) technology to give excellent adhesion to stainless steel and anodized aluminum.
- Controlled Fusion also allows extended recoat times and removes the need for sanding before applying the next coat.
- Eliminates hazardous chemicals from the process.
- Ensures strong adhesion with the Awlcraft system.
- Can be directly overcoated with Awlgrip, Awlgrip HS or Awlcraft 2000.

Order No.	Mfg. No. / Description		List Price	
508440	(D6600/1QTUS) Yellow Base	Quart	\$44.59	E0-4433000
508390	(D3300/1QTUS) Converter	Quart	\$29.39	E0-4022000

**Awlcat Converters**



**Mixing Ratio**

AWL-CAT #2	Spray	1 to 1
AWL-CAT #3	Brushing	2 to 1

Order No.	Mfg. No. / Description		List Price	
509755	(G3010/1GLUS) #2 Spray	Gallon	\$222.89	E0-7176100
509779	(G3010/1QTUS) #2 Spray	Quart	\$74.39	E0-9755000
509767	(G3010/1PTUS) #2 Spray	Pint	\$47.49	E0-2653000
510328	(H3002/1HGUS) #3 Brushing	1/2 Gallon	\$191.09	E0-2334100
510330	(H3002/1PTUS) #3 Brushing	Pint	\$63.89	E0-2974000
509816	(G3039/1GLUS) #5 Spray	Gallon	\$249.99	E0-9478100

**AWLGRIP® Hullgard Extra Epoxy Primer**



- An epoxy holding primer, used to provide a stable base for subsequent fairing.
- Offers superb adhesion to properly prepared fiberglass, steel, aluminum and wood.
- For use above and below the waterline.
- Offers excellent re-coatability for aged surfaces.
- Excellent anticorrosive properties.
- Provides the perfect base for Awlfair fairing compound.

Order No.	Mfg. No. / Description		List Price	
508432	(D6120/1GLUS) White Base	Gallon	\$89.39	E0-4076000
508407	(D3730/1QTUS) Converter	Quart	\$28.79	E0-9512000

**AWLGRIP® Flattening Agent**



- Awlgrip Flattening Agent can be used with Awlgrip Topcoat and Awlcraft 2000 to achieve a flat or semi-gloss finish.
- Newly reformulated for greater stability.
- Ideal for interior application.
- Recommended for use at 20° C/68° F or higher.
- Tailored for application by spray.

Order No.	Mfg. No. / Description		List Price	
509781	(G3013/1GLUS) Gallon		\$145.49	E0-2190100
509793	(G3013/1QTUS) Quart		\$48.39	E0-9263000

**Awlcat Clear Converters**



Order No.	Mfg. No. / Description		List Price	
510683	(J3006/1HGUS) 1/2 Gallon		\$194.19	E0-4654100
510695	(J3006/1PTUS) Pint		\$64.89	E0-7684000

**Awlbrite Clear Gloss Base**



- Reduce with T0180.
- | Order No. | Mfg. No. / Description |  | List Price |            |
|-----------|------------------------|--|------------|------------|
| 510669    | (J3005/1GLUS) Gallon   |  | \$228.49   | E0-7317100 |
| 510671    | (J3005/1QTUS) Quart    |  | \$74.29    | E0-2755000 |

**SPECIAL HANDLING MAY APPLY**

- Electronics
- Trolling Motors
- Instruments
- Electrical
- Lighting
- Anchor & Dock
- Safety
- Steering, Controls
- Pumps
- Fuel System
- Seating & Pedestals
- Trailer
- Tops & Covers
- Perform.
- Propellers
- Engine & Care
- Cleaning & Care
- Paint & Paint Acc.
- Fun & Flotation
- Topside Acc.
- Cockpit & Deck
- Hardware, Fasteners
- Camouflage
- Misc.
- Comm.

**AWLGRIP® Reducer T0003 Standard**



- Standard reducer for use with Awlgrip finishes between 21-32° C/70-90° F.

Order No.	Mfg. No. / Description	List Price
510873	(T0003/1GLUS) Gallon	\$60.69 E0-2554000
510885	(T0003/1QTUS) Quart	\$20.79 E0-9551000

**AWLGRIP® Reducer T0001 Fast Spray**



- Fast-evaporating reducer for use with spray-applied Awlgrip finishes, between 16-24° C/ 60-75° F.

Order No.	Mfg. No. / Description	List Price
510835	(T0001/1GLUS) Gallon	\$60.59 E0-4454000
510847	(T0001/1QTUS) Quart	\$20.19 E0-4151000

**AWLGRIP® Reducer T0002 Fast Spray**



- Fast-evaporating reducer for equipment cleaning and use with Awlgrip finishes, between 13-21° C/50-70° F.

Order No.	Mfg. No. / Description	List Price
510859	(T0002/1GLUS) Gallon	\$52.99 E0-4793000

**AWLGRIP® Reducer T0031 Brush**



- Epoxy reducer for use when brushing or rolling 545 Epoxy Primer or Awlquick Primer.

Order No.	Mfg. No. / Description	List Price
510986	(T0031/1GLUS) Gallon	\$76.79 E0-9575000
510998	(T0031/1QTUS) Quart	\$25.59 E0-9191000

**AWLGRIP® Reducer T0005 Hot Weather**



- Hot-weather reducer for use with Awlgrip finishes between 32-41° C/90-105° F.

Order No.	Mfg. No. / Description	List Price
510900	(T0005/1QTUS) Quart	\$31.99 E0-9932000

**AWLGRIP® Reducers - VOC**



Order No.	Mfg. No. / Description	List Price
511068	(T0167/1GLUS) Standard Gallon	\$69.09 E0-2815000
511074	(T0168/1QTUS) Hot Weather Quart	\$35.39 E0-4562000
511089	(T0163/1GLUS) Fast - Spray Gallon	\$67.09 E0-2305000
511090	(T0163/1QTUS) Fast - Spray Quart	\$22.39 E0-9761000

**AWLGRIP® Reducer T0006 Epoxy Reducer**



- Standard epoxy reducer for use with a range of spray-applied Awlgrip primers.

Order No.	Mfg. No. / Description	List Price
510924	(T0006/1GLUS) Gallon	\$56.29 E0-2224000
510936	(T0006/1QTUS) Quart	\$19.69 E0-7741000

- Electronics
- Trolling Motors
- Instruments
- Electrical
- Lighting
- Anchor & Dock
- Safety
- Steering, Controls
- Pumps
- Fuel System
- Seating & Pedestals
- Trailing
- Tops & Covers
- Perform.
- Propellers
- Engine & Care
- Cleaning & Care
- Paint & Paint Acc.
- Fun & Flotation
- Topside Acc.
- Cockpit & Deck
- Hardware, Fasteners
- Camouflage
- Misc.
- Comm.

**SPECIAL HANDLING MAY APPLY**



- Electronics
- Trolling Motors
- Instruments
- Electrical
- Lighting
- Anchor & Dock
- Safety
- Steering, Controls
- Pumps
- Fuel System
- Seating & Pedestals
- Trailer
- Tops & Covers
- Perform.
- Propellers
- Engine & Care
- Cleaning & Care
- Paint & Paint Acc.
- Fun & Flotation
- Topside Acc.
- Cockpit & Deck
- Hardware, Fasteners
- Camouflage
- Misc.
- Comm.

**AWLGRIP® Awlprep**



- A fast-evaporating, wipe down solvent used to remove oils, light grease and other surface contaminants from finish primers and finish.
- Use before and after the sanding of primers, fillers and finishes.
- Removes latent moisture from the coating's surface.
- Helps in achieving a flawless high gloss finish.
- Non-photochemically reactive.



Order No.	Mfg. No. / Description	List Price
<b>510950</b>	(T0008/1GLUS) Gallon	<b>\$48.49</b> E0-7363000

**AWLGRIP® Awlprep 400**



- A general-purpose wipe down solvent used to remove hand oils, grease and other light surface contaminants from finished surfaces before and after sanding.
- Recommended for use in warm weather.
- Evaporates 5 times slower than T0008.
- Ideal for removing tape residue.
- Non-photochemically reactive.



Order No.	Mfg. No. / Description	List Price
<b>511077</b>	(T0170/1GLUS) Gallon	<b>\$43.19</b> E0-9323000

**AWLGRIP® Awlcraft SE Blending Solvent**



- For use with repairing an Awlcraft SE Topcoat.

Order No.	Mfg. No. / Description	List Price
<b>511110</b>	(T0195/1QTUS) Quart	<b>\$86.19</b> E0-4646000

**AWLGRIP® Pro-Cure Accelerator**



- A specialized accelerator used to reduce dry and cure times for Awlgrip and Awlcraft 2000.
- Functions as an additive for finishes, do not use with primers.
- Can reduce dry times to as little as 1-2 hours.
- Tailored for use with Awlgrip finishes.
- Streamlines the application process.

Order No.	Mfg. No. / Description	List Price
<b>508107</b>	(73014/20ZUS) X98 Accelerator 2 oz.	<b>\$17.79</b> E0-4331000
<b>508119</b>	(73015/20ZUS) X138 Inhibite Accelerator 2 oz.	<b>\$17.79</b> E0-4331000

**AWLGRIP® Awlprep Plus**



- A medium-fast evaporating wipe down solvent designed to remove waxes, grease and oils commonly found on painted surfaces, new or aged gelcoat, aluminum or steel.
- Use before and after sanding the substrate, prior to priming.
- Removes wax residue and grease from substrates.
- Promotes adhesion to substrates.
- Works for a variety of painted and metal surfaces.



Order No.	Mfg. No. / Description	List Price
<b>511041</b>	(T0115/1GLUS) Gallon	<b>\$52.09</b> E0-7093000

**AWLGRIP® Deluxe Tack Rags**



- A premium tack rag used to remove dust and dirt without depositing contamination on the surface, leaving it clean and ready to paint.

Order No.	Mfg. No. / Description	List Price
<b>508056</b>	(73009/1EAAL) 4 Per Pack	<b>\$6.49</b> E0-7840000

**AWLGRIP® Brushing Activator/Reducer for Awlbrite Clear**



- A special blend of solvents and additives which is a required part of the Awlbrite Clear mix.
- A0031 contains additives which stabilize the pot life of the mixture and initiate cure of the product.

Order No.	Mfg. No. / Description	List Price
<b>508183</b>	(A0031/1PTUS) Pint	<b>\$26.99</b> E0-4202000

**AWLGRIP® Griptex Non-Skid Additive**



- A non-skid polymer bead aggregate used to coat deck and step areas with a non-slip coating.
- Apply by spray or mix with any Awlgrip finish.
- Available in Fine, Coarse and Extra Coarse.
- Can be applied by spray.
- Compatible with any Awlgrip finish.



Order No.	Mfg. No. / Description	List Price
<b>508070</b>	(73012/1GLAL) Fine Grit Gallon	<b>\$114.39</b> E0-9758000
<b>508068</b>	(73012/1QTAL) Fine Grit Quart	<b>\$38.19</b> E0-4682000
<b>508094</b>	(73013/1GLAL) Coarse Grit Gallon	<b>\$124.29</b> E0-2239000
<b>508082</b>	(73013/1QTAL) Coarse Grit Quart	<b>\$41.39</b> E0-4013000
<b>508145</b>	(73237/1QTAL) Extra Coarse Grit Quart	<b>\$44.29</b> E0-2233000

**SPECIAL HANDLING MAY APPLY**

**AWLGRIP® Awlfair LW Fast Fairing Compound**



- A premium trowelable epoxy filler, which acts as a fairing compound for the smoothing of irregular surfaces.
- Allows the creation of a level, even surface which reduces drag and improves the boat's appearance.
- Sandable after 6 hours at 25° C.
- Provides a super-smooth finish and easy sanding.
- Suitable for manual and automatic mixing.
- Can be applied above and below the waterline.

Order No.	Mfg. No. / Description	List Price
508626	(D8200/5GLUS) White Base 5 Gallon	\$643.39 E0-4528400
508628	(D8200/2GLUS) White Base 2 Gallon	\$250.99 E0-4288100
508630	(D8200/1GLUS) White Base Gallon	\$131.49 E0-2689000
508632	(D8200/1QTUS) White Base Quart	\$44.69 E0-2533000
508481	(D7222/5GLUS) Red Converter 5 Gallon	\$678.29 E0-2780500
508483	(D7222/2GLUS) Red Converter 2 Gallon	\$257.39 E0-4039100
508482	(D7222/1GLUS) Red Converter Gallon	\$134.89 E0-7110100
508484	(D7222/1QTUS) Red Converter Quart	\$44.69 E0-2533000

**AWLGRIP® Sprayable Fairing Compound**



- An epoxy surfacer used on large fairing surfaces as an insulator/surfacer before High Build Primer or Ultra Build Primer is applied.
- For use above the waterline only.
- Excellent sag resistance and film build capacity.
- Easy to sand, making large areas quicker to sand.
- Saves time when applying multiple coats.

Order No.	Mfg. No. / Description	List Price
508412	(D6001/1GLUS) Tan Base Gallon	\$148.79 E0-9511100
508361	(D3011/1GLUS) Converter Gallon	\$148.69 E0-2511100

**AWLGRIP® Awlfair LW Standard Fairing Compound**



- A premium trowelable epoxy filler, which acts as a fairing compound for the smoothing of irregular surfaces.
- Allows the creation of a level, even surface which reduces drag and improves the boat's appearance.
- Sandable after 17 hours at 25° C.
- Provides a super-smooth finish and easy sanding.
- Suitable for manual and automatic mixing.
- Can be applied above and below the waterline.

Order No.	Mfg. No. / Description	List Price
508626	(D8200/5GLUS) White Base 5 Gallon	\$643.39 E0-4528400
508628	(D8200/2GLUS) White Base 2 Gallon	\$250.99 E0-4288100
508630	(D8200/1GLUS) White Base Gallon	\$131.49 E0-2689000
508632	(D8200/1QTUS) White Base Quart	\$44.69 E0-2533000
508474	(D7200/5GLUS) Red Converter 5 Gallon	\$643.39 E0-4528400
508476	(D7200/2GLUS) Red Converter 2 Gallon	\$250.99 E0-4288100
508478	(D7200/1GLUS) Red Converter Gallon	\$127.69 E0-7759000
508480	(D7200/1QTUS) Red Converter Quart	\$44.69 E0-2533000

**AWLGRIP® Awlwash**



- A wash down concentrate formulated to clean Awlgrip, Awlgrip HS and Awlcraft 2000. Contains no alkalis, acids or abrasives.
- Formulated specifically for Awlgrip.
- Free-rinsing formula for faster drying.
- 100% biodegradable.

Order No.	Mfg. No. / Description	List Price
508121	(73234/1GLAL) Gallon	\$50.29 E0-2773000
508133	(73234/1QTAL) Quart	\$16.79 E0-9521000

**AWLGRIP® AWLCARE Protective Polymer Sealer**



- A protective polymer sealer, formulated to protect Awlgrip, Awlcraft 2000 and Awlgrip HDT from acid rain, environmental pollutants and abrasion.
- Leaves a non-yellowing protective coat that lasts through multiple washings.
- Contains no abrasives and will not scratch the painted surface.
- Removes mild stains such as water spots and diesel soot.
- Increases resistance to acid rain and other environmental pollutants.

Order No.	Mfg. No. / Description	List Price
508157	(73240/1HGUS) 1/2 Gallon	\$57.29 E0-7924000
508169	(73240/1PTUS) Pint	\$19.09 E0-2341000



**SPECIAL HANDLING MAY APPLY**



- Electronics
- Trolling Motors
- Instruments
- Electrical
- Lighting
- Anchor & Dock
- Safety
- Steering, Controls
- Pumps
- Fuel System
- Seating & Pedestals
- Trailering
- Tops & Covers
- Perform.
- Propellers
- Engine & Care
- Cleaning & Care
- Paint & Paint Acc.
- Fun & Flotation
- Topside Acc.
- Cockpit & Deck
- Hardware, Fasteners
- Camouflage
- Misc.
- Comm.

Marpro Color Matched Engine Spray Paint



- Easy to use aerosols deliver professional results every time.
- Ideal for entire outboard and sterndrive reconditioning or touch up!
- Acrylic lacquer formula for a long lasting glossy base coat marine finish.
- It also protects with UV inhibitors!
- Excellent solvent, gasoline and wear resistance.
- Meet VOC requirements.
- 12 oz. canister.
- To achieve the finest deep gloss finish available use Marpro Clear Coat 6-6995 as the final coat.
- Price per can.



HONDA MOTOR COLORS

6-7021 Silver Metallic \$11.09 FO-6770000

MERCURY MOTOR COLORS

6-1258 Phantom Black OEM #92-78373-12, 1960-Present \$10.59 FO-1470000

OMC DRIVE SYSTEM COLORS

6-6979 Charcoal (Metallic) OEM #395127, 1985-Present \$11.09 FO-6770000

SUZUKI MOTOR COLORS

6-7040 Shadow Black \$11.09 FO-6770000

YAMAHA MOTOR COLORS

6-7003 Metallic Dark Blue \$11.09 FO-6770000

- Electronics
- Trolling Motors
- Instruments
- Electrical
- Lighting
- Anchor & Dock
- Safety
- Steering, Controls
- Pumps
- Fuel System
- Seating & Pedestals
- Trailering
- Tops & Covers
- Perform.
- Propellers
- Engine & Care
- Cleaning & Care
- Fun & Flotation
- Topside Acc.
- Cockpit & Deck
- Hardware, Fasteners
- Camouflage
- Misc.
- Comm.

Marpro Drivesleek™ Outdrive Paint



- Full season protection.
- Excellent for outdrives, propellers, shafts, bow thrusters, rudders, trim tabs.
- Compatible with other existing coatings.
- 12 oz. can.

Order No.	Description	List Price	
7-2595	Primer	\$26.09	FO-6281000

Marpro Zinc Chromate Primers



- Superior bonding to aluminum lower units.
- Formulated to work with engine paints.
- For use below water line.
- Protects against corrosion.
- Quick-dry formula.
- 12 oz. can.

Order No.	Description	List Price	
6-5605	Green	\$10.09	FO-6070000
6-5606	Yellow	\$11.09	FO-6770000

Marpro Inboard/Generator Engine Colors



- Factory matched colors.
- Resistant to oil and gasoline.
- Fuses to the engine surface.
- Can be recoated anytime.
- Quick dry formula formulated for the marine environment.
- 12 oz. can.

Order No.	Description	List Price	
6-0214	New Caterpillar Yellow	\$11.69	FO-8180000
6-0225	GM Green	\$11.69	FO-8180000

Marpro Cold Zinc Galvanizing



- 95% pure zinc formula.
- Recommended for steel and iron surfaces (including welded joints).
- Perfect for hardware corrosion protection.
- Resists abrasions and solvents.
- Quick-dry formula.
- 13 oz. can.

Order No.	Description	List Price	
6-0800	Cold Zinc Galvanizing	\$12.09	FO-6480000





## Evinrude Johnson Touch-Up Paint



Order No.	Mfg. No.	Color		List Price	
E351907	(351907)	Dark Blue Spectracron (Base Coat)	2005-Thru	\$12.69	ZO-1670000
E771240	(771240)	Blue/Silver	1987-88	\$12.50	ZO-0570000
E771244	(771244)	XP - Dark Blue	1986-88	\$12.50	ZO-0570000
E771269	(771269)	Arctic White	1967-71	\$12.50	ZO-0570000
E772049	(772049)	Dark Charcoal	1994-Thru	\$12.59	ZO-5570000
E772633	(772633)	Platinum	1999-Thru	\$12.50	ZO-0570000
E772727	(772727)	Gunmetal Silver	2000	\$12.50	ZO-0570000
E777171	(777171)	White (Base Coat)	1981-Thru	\$12.19	ZO-1370000
E777172	(777172)	Primer (Midsection and Gearcase)		\$12.50	ZO-0570000
E777173	(777173)	Charcoal/GT 1987-Thru (Outdrive 1986-Thru)		\$13.19	ZO-1970000
E777174	(777174)	Metallic Dark Blue	1989-93	\$12.50	ZO-0570000
E777175	(777175)	Metallic Blue	1992-05	\$12.19	ZO-1370000
E777176	(777176)	Metallic Light Blue	1978-87	\$12.19	ZO-1370000
E777177	(777177)	Graphite/Smoke (Base Coat)	1998-AB	\$12.50	ZO-0570000
E777178	(777178)	White - Johnson 1972-80; OMC 1977-Thru		\$12.50	ZO-0570000
E777179	(777179)	Black Gloss (Engine Cyl./Crankcase) 1985-05		\$12.50	ZO-0570000
E777180	(777180)	Silver Blue	1983-86	\$12.50	ZO-0570000
E777181	(777181)	Charcoal (Non-Metallic)	1986-93	\$13.09	ZO-5870000
E777182	(777182)	White	1991	\$12.50	ZO-0570000



- Use for touch-up of gearcases and other painted metal parts.
- Matches the original color of Evinrude or Johnson outboard or drive system.
- For best results, use primer, base coat and clear coat.
- May not be compatible with some plastics.

## Moeller Engine Paint

## HONDA MOTOR COLORS

Order No.	Mfg. No. / Description	List Price	
4810032	(025516) Oyster Silver Metallic	\$9.99	F0-9960000

## OMC MOTOR COLORS

Order No.	Mfg. No. / Description	List Price	
4810012	(025425) White (1964-76)	\$9.99	F0-9960000
4810013	(025433) White (1977-80)	\$9.99	F0-9960000
4810019	(025478) Charcoal (1986-Present)	\$9.99	F0-9960000

## SUZUKI MOTOR COLORS

Order No.	Mfg. No. / Description	List Price	
4810028	(025804) Shadow Black	\$9.99	F0-9960000
4810029	(025805) Charcoal Metallic	\$9.99	F0-9960000

## TOHATSU MOTOR COLORS

Order No.	Mfg. No. / Description	List Price	
4810022	(025513) Light Blue Metallic (1984-Present)	\$9.99	F0-9960000

## VOLVO MOTOR COLORS

Order No.	Mfg. No. / Description	List Price	
4810021	(025488) Grey (1989-Present)	\$9.99	F0-9960000

## YAMAHA MOTOR COLORS

Order No.	Mfg. No. / Description	List Price	
4810025	(025469) Metallic Blue Silver (1985-90)	\$9.99	F0-9960000
4810026	(025515) Metallic Dark Blue	\$9.99	F0-9960000
4810030	(025814) Blue Gray	\$9.99	F0-9960000



- Acrylic lacquers formulated for extended staying power.
- Color matched to the engine's original color.
- For use on all outboard and inboard engines, stern drive and lower units.
- Fast drying. Superior durability.
- Resistant to gasoline, oil and heat.
- Good hiding and adhesion.
- 12 oz. net weight.

## Moeller Engine Paint - Color Vision



- Heat and solvent resistant.
- Formulated for the marine environment.
- Color matched to the engine's original color.
- Approved for use up to 250°.
- For use on all outboard and inboard engines, stern drive and lower units.
- Quick-dry formula.
- Oil and gasoline resistant.
- 12 oz. net weight.

Order No.	Mfg. No. / Description	List Price	
4810023	(025104) Caterpillar Yellow	\$9.99	F0-9960000
4810024	(025225) Alpine GM Green (1977-Present)	\$9.99	F0-9960000

## Moeller Engine Paint - Clear Coat



- Formulated for the marine environment.
- For use on all outboard and inboard engines, stern drive and lower units.
- Increases luster and depth.
- Quick-dry formula.
- Enhanced UV protection.
- 12 oz. net weight.

Order No.	Mfg. No. / Description	List Price	
4810027	(025519)	\$9.99	F0-9960000

**Preval vFan Portable Airbrush System Kit**

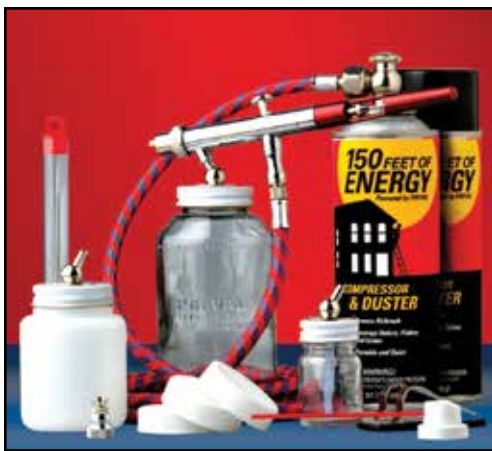

- Kit includes:
  - (1) vFan Airbrush with .9 mm fan air cap & .9 mm detail air cap.
  - (2) Cans of 150 Feet of Energy.
  - (3) Product containers with full assembly.
- (1) 6' long air hose.
- (1) Extra .9 mm spray needle.
- (1) Pressure tank regulator for 150 feet of energy.
- Additional dip tubes and accessories.
- The vFan Portable Airbrush is an all-in-one touch-up system for precision painting, surface prep, touch-ups and curing - anywhere and anytime.
- Our siphon-fed, dual-action stainless steel and brass vFan airbrush delivers professional results with a silent pressurized can compressor that fits in your pocket: 150 Feet of Energy.
- The vFan sprays: Gel coats, Clear coats, Water based paints, Solvent based paints, Oil based paints, Latex paints and over 2,000 formulas.
- Protected against all solvents.
- Includes a 1 year warranty.

Order No.	Mfg. No. / Description	List Price
556211	(0100)	\$205.99 F0-9144100

**Preval 150 Feet of Energy (Portable Compressor Unit)**

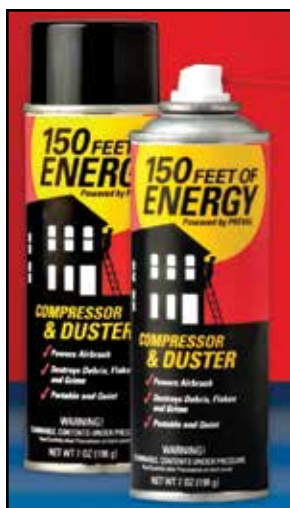

- Preval's 150 Feet of Energy is a 2-in-1 pocket compressor and duster.
- Each unit delivers 15 - 40 square feet of paint coverage and with enough cubic feet per minute to deliver a perfect finish using Automotive paints, lacquers, urethanes, latex, clear coat, solvent based paints and more.
- 150 Feet of Energy also works as a powerful air duster to blow out hard-to-reach spaces and reduce cleanup times.
- Get 5x the spray time with our Energy Disbursement Unit, Pressure Regulator is sold separately.

Order No.	Mfg. No. / Description	List Price
556222	(0168) 7 oz.	\$6.99 F0-9840000

**Marpac Paint Spray Gun**



- HVLP gun with durable metal body.
- Designed for use with a wide variety of paints.
- Includes polypropylene bottle.
- Low - air and paint applied in uniform layers.
- Excellent internal.

Order No.	Description	List Price
7-1069	Paint Spray Gun	\$59.89 G0-3104000

**The Preval Sprayer System (Portable)**



556209



556196

	Power Capacity for:
Gel Coat	2 - 6 oz.
Oil and Alkyd Base Paint	6 - 9 oz.
Varnish and Enamel	9 - 12 oz.
Model Lacquer	12 - 16 oz.

- It's disposable, recyclable, easy to clean and, best of all, no compressor is needed.
- The Preval Sprayer's patented venturri vacuum process pulls liquid from any compatible, removable and refillable container and delivers a professional-grade spray stream to virtually any surface.
- Easy replacement and cleanup with interchangeable and disposable parts.
- Store media in containers for easy reuse.
- Professional-grade finish.
- Kit includes: Spray unit, glass bottle and long dip tube.

Order No.	Mfg. No. / Description	List Price
556184	(267) Kit	\$6.79 F0-5740000
556196	(268) Replacement Spray Unit	\$5.49 F0-4830000
556209	(269) Replacement 6 oz. Glass Reservoir	\$1.49 F0-4010000

- Electronics
- Trolling Motors
- Instruments
- Electrical
- Lighting
- Anchor & Dock
- Safety
- Steering, Controls
- Pumps
- Fuel System
- Seating & Pedestals
- Trailer
- Tops & Covers
- Perform.
- Propellers
- Engine & Care
- Cleaning & Care
- Paint & Paint Acc.
- Fun & Flotation
- Topside Acc.
- Cockpit & Deck
- Hardware, Fasteners
- Camouflage
- Misc.
- Comm.

3M Marine Accuspray™ ONE Spray Gun Kit



- Durable, lightweight 1-piece composite spray gun body eliminates maintenance kits.
- Complete selection of replaceable atomizing heads allows for a range of applications and fluid viscosities.
- Air control valve helps regulate up to 12" vertical or horizontal spray patterns.
- Kit includes: Accuspray ONE spray gun, (1) 1.2 mm, (1) 1.3 mm, (1) 1.4 mm, (1) 1.8 mm, (1) 2.0 mm, air flow control valve, colored identification clips and gun hanger.

Order No. Mfg. No. / Description List Price  
**886795** (16578) **\$353.99** F0-9774200

3M Marine Accuspray™ ONE Spray Gun System with Standard PPS™



- An all-in-one solution for mixing/measuring, filtering and spraying of liquid coating materials.
- Replaceable atomizing heads afford the performance of a brand new gun on demand.
- Selection of atomizing heads allows for spraying primer, sealer, base and clear coat.
- PPS reduces cleaning solvent consumption up to 70% and reduces prep and clean-up time by 50%.
- Kit includes: Accuspray ONE spray gun, atomizing heads, hard cup, lids, liners and more.

Order No. Mfg. No. / Description List Price  
**886793** (16580) **\$328.49** F0-4992200

3M Marine PPS™ Type H/O Pressure Cup



- Pressurized hard cups and collars use with 3M PPS (Legacy) paint preparation system.
- Designed to efficiently spray thick, high viscosity liquids.

Order No. Mfg. No. / Description List Price  
**886772** (16121) 6 oz. **\$59.39** F0-7514000

3M Marine Accuspray™ HGP Spray Gun Kit



- The equivalent of a new spray gun whenever you need it, for a fraction of the cost.
- Replaceable atomizing heads reduce cleanup time and maximize consistent application.
- Excellent atomization delivers large usable spray pattern, high transfer efficiency.
- Lightweight composite body is designed for operator comfort.
- Works in conjunction with the 3M PPS H/O type cups - user can spray at any angle, even upside down.
- Kit includes: Accuspray HGP spray gun, (2) 1.8 mm and (2) 2.0 mm atomizing heads and one airflow control valve.

Order No. Mfg. No. / Description List Price  
**886803** (16587) **\$333.39** F0-7333200

3M Marine Accuspray™ Atomizing Head - 2.0 mm



- Replaceable atomizing heads for use with the 3M Accuspray Spray System.
- Includes: (4) red atomizing heads.
- For heavy coatings.

Order No. Mfg. No. / Description List Price  
**886796** (16609) 2.0 mm **\$33.19** F0-3232000

3M Marine Accuspray™ Atomizing Head - 1.8 mm



- Replaceable atomizing heads for use with the 3M Accuspray Spray System.
- Includes: (4) clear atomizing heads.
- For medium viscosity coatings.

Order No. Mfg. No. / Description List Price  
**886797** (16611) 1.8 mm **\$32.19** F0-3522000

3M Marine Accuspray™ Atomizing Head - 1.4 mm



- Replaceable atomizing head for use with the 3M Accuspray Spray System.
- Includes: (4) orange atomizing heads.
- For finer finishes.

Order No. Mfg. No. / Description List Price  
**886794** (16612) 1.4 mm **\$33.19** F0-3232000

- Electronics
- Trolling Motors
- Instruments
- Electrical
- Lighting
- Anchor & Dock
- Safety
- Steering, Controls
- Pumps
- Fuel System
- Seating & Pedestals
- Trailering
- Tops & Covers
- Perform.
- Propellers
- Engine & Care
- Cleaning & Care
- Paint & Paint Acc.
- Fun & Flotation
- Topside Acc.
- Cockpit & Deck
- Hardware, Fasteners
- Camouflage
- Misc.
- Comm.



- Electronics
- Trolling Motors
- Instruments
- Electrical
- Lighting
- Anchor & Dock
- Safety
- Steering, Controls
- Pumps
- Fuel System
- Seating & Pedestals
- Trailer
- Tops & Covers
- Perform.
- Propellers
- Engine & Care
- Cleaning & Care
- Fun & Flotation
- Topside Acc.
- Cockpit & Deck
- Hardware, Fasteners
- Camouflage
- Misc.
- Comm.

**3M Marine PPS™ Mixing Cup and Collar**



- Hard cups and collars support liners for the 3M PPS (Legacy) paint preparation system.
- 3M PPS is an all-in-one disposable solution for measuring, mixing, filtering and spraying of paint materials.
- System enables the painter the ability to consistently spray at 90° to the part, no matter the part orientation (even upside down).
- The all-in-one solution reduces the chance of outside contamination and reduces paint consumption.

MINI - FOR USE WITH LINER 16114			
Order No.	Mfg. No. / Description	List Price	
886769	(051131-16115) 6 oz.	\$37.79	F0-5462000
STANDARD - FOR USE WITH LINER 16000			
Order No.	Mfg. No. / Description	List Price	
886763	(16001) 22 oz.	\$50.69	F0-8453000
LARGE - FOR USE WITH LINER 16024			
Order No.	Mfg. No. / Description	List Price	
886789	(16023) 28 oz.	\$32.19	F0-3522000

**Wood Handle Foam Brushes**



- High density closed cell foam.
  - Wood peg handle.
- | Order No. | Description | List Price |            |
|-----------|-------------|------------|------------|
| 570350    | Size: 1"    | \$0.29     | H0-7100000 |
| 570362    | Size: 2"    | \$0.49     | H0-9200000 |
| 570374    | Size: 3"    | \$0.59     | H0-5300000 |
| 570375    | Size: 4"    | \$0.79     | H0-7400000 |

**Marpro Bucket of Savings Chip Brushes**



- Sold 48 brushes per bucket.
  - Size: 2".
- | Order No. | Description | List Price |            |
|-----------|-------------|------------|------------|
| 7-0508S   |             | \$36.99    | G0-8742000 |

**3M Marine PPS™ Kits**



- The 200 micron filters are recommended for traditional solvent based paint or primer applications.

MINI SIZE			
• Kit contains: (50) disposable lids with 200 micron filters, (50) disposable liners and (20) sealing plugs.			
Order No.	Mfg. No. / Description	List Price	
886767	(16114) Holds 6 oz.	\$128.89	F0-2209000
STANDARD SIZE			
• Kit contains: (50) disposable lids with 200 micron filters, (50) disposable liners and (20) sealing plugs.			
Order No.	Mfg. No. / Description	List Price	
886762	(16000) Holds 22 oz.	\$168.09	F0-6671100
LARGE SIZE			
• Kit contains: (25) disposable lids with 200 micron filters, (25) disposable liners and (10) sealing plugs.			
Order No.	Mfg. No. / Description	List Price	
886791	(16024) Holds 28 oz.	\$98.99	F0-9296000

**Radiator Brush**

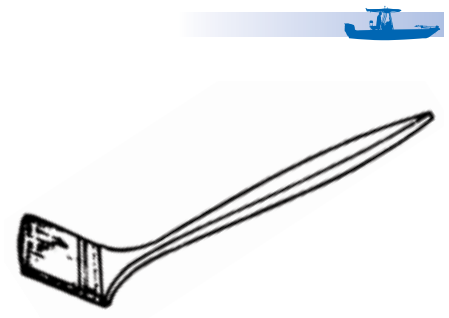

- Black china bristle bent radiator brush.
  - 45° angle for easy access.
  - Size: 2".
- | Order No. | Mfg. No. / Description | List Price |            |
|-----------|------------------------|------------|------------|
| 570460    | (PB1213)               | \$2.19     | F0-3510000 |

Marpro White China Bristle Brushes



- 100% White China Bristles.
- Excellent for use with oil paints, varnish and stains, and all marine coatings.

Order No.	Description	List Price	
7-1060	Size: 1"	\$3.29	GO-0220000
7-1061	Size: 1-1/2"	\$4.19	GO-1820000
7-1062	Size: 2"	\$5.19	GO-8430000
7-1063	Size: 2-1/2"	\$6.29	GO-1240000
7-1064	Size: 3"	\$10.09	GO-6760000

Corona Deck & Cabin™ Brushes



- 100% White China Bristle.
- Excellent for enamels, varnish and all purpose.
- Hand formed chisel for sharp cutting in.
- Hardwood panel handle.

Order No.	Mfg. No.	Size	List Price	
571148	(3058-1)	1"	\$8.09	HO-5840000
570437	(3058-2)	2"	\$13.39	HO-3080000
571162	(3058-3)	3"	\$19.69	HO-1811000
571174	(3058-4)	4"	\$27.99	HO-9761000

Corona Europa™ Brushes - Badger Style



- Soft Badger style pure China bristle.
- Excellent for polyurethanes, rolling and tipping and more.
- Hand formed chisel for sharp cutting in.
- Hardwood peg handle.

Order No.	Mfg. No.	Size	List Price	
571000	(16038-1)	1"	\$13.39	HO-3080000
570223	(16038-1.5)	1-1/2"	\$17.09	HO-5201000
570235	(16038-2)	2"	\$22.29	HO-7331000
570247	(16038-2.5)	2-1/2"	\$28.89	HO-3371000
570253	(16038-3)	3"	\$35.19	HO-1112000
570257	(16038-4)	4"	\$42.99	HO-9752000

Corona Urethaner™ Brushes



- 100% white China bristle.
- Excellent for polyurethanes, enamels and bottom paints.
- Hand formed chisel for sharp cutting in.
- Plastic foam Kaiser handle.

Order No.	Mfg. No.	Size	List Price	
571249	(3052-1)	1"	\$6.29	HO-7730000
570402	(3052-1.5)	1-1/2"	\$8.59	HO-5150000
570403	(3052-2)	2"	\$10.59	HO-5360000
570404	(3052-2.5)	2-1/2"	\$13.99	HO-9380000
570405	(3052-3)	3"	\$16.49	HO-9890000
571299	(3052-4)	4"	\$23.19	HO-1931000

Corona TopSail™ Brushes



- Triple thick stock of white China Bristle.
- Finest quality varnish applicator.
- Hand formed chisel for sharp cutting in.
- Hardwood kaiser handle.

Order No.	Mfg. No.	Size	List Price	
571061	(3080-1)	1"	\$12.69	HO-1670000
571085	(3080-2)	2"	\$23.79	HO-7241000
571100	(3080-3)	3"	\$36.59	HO-5912000

Corona Glasskoter™ Brushes



- Pure white bristle.
- Solvent resistant plastic handle.
- Tin ferrule.

Order No.	Mfg. No.	Size	List Price	
570326	(3015-1)	1"	\$2.59	HO-5510000
570327	(3015-1.5)	1-1/2"	\$3.09	HO-5810000
570329	(3015-2)	2"	\$3.79	HO-7220000
570330	(3040-4)	4"	\$11.69	HO-1070000

"Throwaway" Brushes - White Bristle



Order No.	Description	List Price	
570273	Size: 1/2"	\$0.39	HO-3200000
570285	Size: 1"	\$0.49	HO-9200000
570297	Size: 1-1/2"	\$0.59	HO-5300000
570300	Size: 2"	\$0.69	HO-1400000
570248	Size: 2", Double Thick	\$1.69	HO-1010000
570312	Size: 2-1/2"	\$0.89	HO-3500000
570324	Size: 3"	\$0.99	HO-9500000
570259	Size: 3", Double Thick	\$2.29	HO-7310000
570336	Size: 4"	\$2.39	HO-3410000
570261	Size: 4", Double Thick	\$4.29	HO-7520000

Arroworthy Paint-Mate Varnish Brush



- White China bristle.
- For oil paints: Interior, exterior, paints, stains, varnish.
- Trim length: 3-3/8".
- Thickness: 11/16".

Order No.	Mfg. No.	Size	List Price	
571491	(9030-4)	4"	\$11.89	GO-7970000

- Electronics
- Trolling Motors
- Instruments
- Electrical
- Lighting
- Anchor & Dock
- Safety
- Steering, Controls
- Pumps
- Fuel System
- Seating & Pedestals
- Trailering
- Tops & Covers
- Perform.
- Propellers
- Engine & Care
- Cleaning & Care
- Paint & Paint Acc.
- Fun & Flotation
- Topside Acc.
- Cockpit & Deck
- Hardware, Fasteners
- Camouflage
- Misc.
- Comm.

Electronics

Trolling Motors

Instruments

Electrical

Lighting

Anchor & Dock

Safety

Steering, Controls

Pumps

Fuel System

Seating & Pedestals

Trailer

Tops & Covers

Perform.

Propellers

Engine & Care

Cleaning & Care

Paint & Paint Acc.

Fun & Flotation

Topside Acc.

Cockpit & Deck

Hardware, Fasteners

Camouflage

Misc.

Comm.

**Marpro Roller Covers**



- 100% Polyester fabric.
- Solvent resistant core.
- For smooth to semi-smooth surface.
- Fiberglass and epoxy applications.

Order No.	Description	List Price
7-1050	Size: 3" 3/8" Nap Sold Each	\$1.19 GO-0800000
7-1051	Size: 4" 3/8" Nap Sold Each	\$1.49 GO-0010000
7-1052	Size: 7" 3/8" Nap Sold Each	\$2.09 GO-0410000
7-1053	Size: 9" 3/8" Nap Sold Each	\$2.09 GO-0410000
7-1049	Size: 9" 3/16" Nap Twin Pack	\$3.99 GO-7620000

**Corona Ultradel™ Roller Cover**



- High-density Golden Polyester.
- Solvent resistant phenolic core.
- For all paints.
- Size: 9".
- Sold each per poly bag.

Order No.	Mfg. No. / Description	List Price
570110	(R-3030F-9) 3/8" Nap	\$7.39 HO-3440000

**Corona Glasskoter™ White Polyester Roller Covers**



- White knitted polyester, medium nap.
- Enamels, bottom paints, all-purpose heavier mill application.
- Solvent resistant phenolic core.
- Sold as individual rollers wrapped in poly bag keepers.

Order No.	Mfg. No. / Description	List Price
570120	(R-201F-3) Size: 3"	\$2.19 HO-1310000
570122	(R-201F-4) Size: 4"	\$2.79 HO-7610000
570134	(MPR-201F-7) Size: 7"	\$3.69 HO-1220000
570146	(MPR-201F-9) Size: 9"	\$4.39 HO-3620000

**Arroworthy Paint-Mate Roller Covers**



- 100% polyester, good for all paints with solvent resistant core.
- Nap height: 3/8".

Order No.	Mfg. No. / Description	List Price
571819	(4P3) Size: 4"	\$1.59 HO-5900000
570019	(9P3) Size: 9"	\$2.19 HO-1310000

**Corona UltraWeave™ Roller Sleeves**



- Hi-density woven extra clean plush acrylic fabric.
- Best for polyurethanes, racing finish bottom paints, enamels and more.
- Super thick phenolic solvent resistant core.
- Sold as individual rollers wrapped in poly bag keepers.

**R-525F ROLLER COVERS WITH 3/16" NAP**

Order No.	Mfg. No. / Description	List Price
571635	(MPR-525F-7) Size: 7"	\$5.09 HO-5030000
571643	(MPR-525F-9) Size: 9"	\$5.69 HO-1430000

**R-530F ROLLER COVERS WITH 3/8" NAP**

Order No.	Mfg. No. / Description	List Price
571681	(MPR-530F-7) Size: 7"	\$6.19 HO-1730000
571693	(MPR-530F-9) Size: 9"	\$6.09 HO-5630000

**Corona Glasskoter™ Red Mohair Roller Covers**



- Woven 1/8" Mohair blend.
- For resins, contact cement, urethanes and all thin mill coatings.
- Solvent resistant phenolic core.
- Sold as individual rollers wrapped in poly bag keepers.

Order No.	Mfg. No. / Description	List Price
571768	(MPR-101F-4) Size: 4"	\$6.69 HO-1040000
571770	(MPR-101F-7) Size: 7"	\$6.09 HO-5630000
570109	(MPR-101F-9) Size: 9"	\$6.59 HO-5930000

**Corona Twin Paks Roller Covers**



- Polyester knit fabric 3/8" nap.
- For one-time use.
- Cardboard core.
- Sold as two rollers wrapped in poly bag keepers.

Order No.	Mfg. No. / Description	List Price
570499	(R-900-9) Size: 9"	\$3.89 HO-3320000

**Arroworthy Tradesman Roller Cover**



- 100% polyester, good for all paints with solvent resistant core.
- Nap height: 1/4".

Order No.	Mfg. No. / Description	List Price
571631	(9DIY2) Size: 9"	\$2.89 HO-3710000



**Corona Slicker™ Foam Roller Covers**



- Fine-celled 1/8" foam.
- For urethanes and varnish on smooth surfaces.
- Solvent resistant phenolic core.
- Sold as individual rollers wrapped in poly bag keepers.

Order No.	Mfg. No. / Description	List Price
570400	(R-780-012F-7) Size: 7"	\$4.39 HO-3620000
570401	(R-780-012F-9) Size: 9"	\$5.19 HO-1130000

**Arrowworthy Economy Imported Roller Frames**



- Light duty use.
- Threaded plastic grip.

Order No.	Mfg. No.	Size	Shank	Cage	List Price
570172	(RF200 0300)	Size: 3"	1/4"	4-Wire	\$3.69 HO-1220000
570184	(RF200 0400)	Size: 4"	1/4"	4-Wire	\$2.99 HO-9710000
570196	(RF200 0700)	Size: 7"	1/4"	4-Wire	\$4.29 HO-7520000
570209	(RF209 0900)	Size: 9"	5/16"	5-Wire	\$3.59 HO-5120000

**Arrowworthy Plastic Paint Trays**

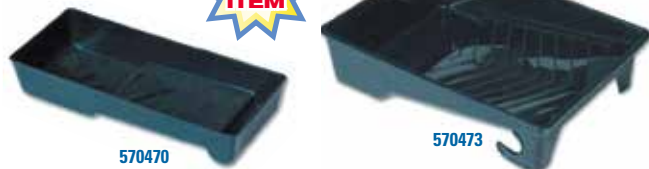

**4" PAINT TRAY - FOR MINI ROLLER**

Order No.	Mfg. No. / Description	List Price
570470	(4RWT-P)	\$2.29 HO-7310000

**9" PAINT TRAY - 2 QUART BLACK PLASTIC WITH ROLLER LEGS**

Order No.	Mfg. No. / Description	List Price
570473	(BWT-P)	\$6.39 HO-3830000

**Corona Ekono Set™ Economy Paint Tray Combo**



- Includes: Metal tray, 3/8" nap polyester cover with cardboard core on cageless roller frame.

Order No.	Mfg. No. / Description	List Price
570500	(R-1000-9) Size: 9"	\$9.99 HO-9950000

**Arrowworthy Foam Roller Cover**



- Yellow foam.
- Smooth.
- Nap height: 3/16"

Order No.	Mfg. No. / Description	List Price
571542	(9PFME) Size: 9"	\$4.89 HO-3920000

**Corona Wood Extension Handle with Die Cast Tip**



- Hardwood extension pole with heavy duty die cast metal tip.
- Overall length 49"

Order No.	Mfg. No. / Description	List Price
575071	(R-1249-DCM)	\$5.89 HO-3530000

**Wood Handle**



- The metal tip wooden handle is selected hardwood with clear lacquered finish.
- One end rounded and other end equipped with crimped-on metal thread.
- Length 60". Diameter 15/16"

Order No.	Mfg. No. / Description	List Price
570175	(HHM60)	\$6.98 CO-3950000

**Corona Paint Trays**



**9" PAINT TRAY**

Order No.	Mfg. No. / Description	List Price
570474	(R-1315-9) Polypropylene 3 Quart Capacity	\$12.39 HO-3470000
570475	(R-1300-9) Bright Metal 2 Quart Capacity	\$6.49 HO-9830000

**PLASTIC TRAY LINER FOR 570475**

Order No.	Mfg. No. / Description	List Price
570476	(R-1303-9)	\$1.69 HO-1010000



**SPECIAL HANDLING MAY APPLY**



- Electronics
- Trolling Motors
- Instruments
- Electrical
- Lighting
- Anchor & Dock
- Safety
- Steering, Controls
- Pumps
- Fuel System
- Seating & Pedestals
- Trailer
- Tops & Covers
- Perform.
- Propellers
- Engine & Care
- Cleaning & Care
- Paint & Paint Acc.
- Fun & Flotation
- Topside Acc.
- Cockpit & Deck
- Hardware, Fasteners
- Camouflage
- Misc.
- Comm.

Marpro Cigar Foam Roller Covers

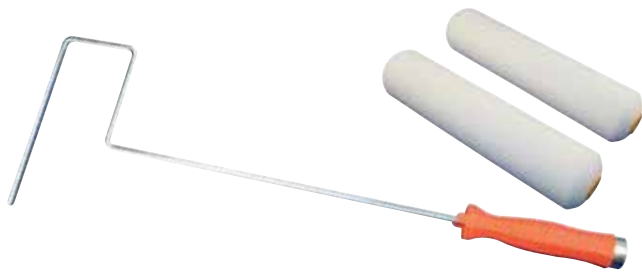

- Foam.
- For smooth to semi-smooth surface.
- Fiberglass and epoxy applications.

Order No.	Description	List Price
7-1038	Size: 4" 3/8" Nap Sold 2 Per Pack	\$2.79 GO-7810000
7-1039	Size: 6-1/2" 3/8" Nap Sold 2 Per Pack	\$4.29 GO-7820000
7-1042	Roller Frame: 4" x 16"	\$1.69 GO-3110000
7-1043	Roller Frame: 6-1/2" x 24"	\$1.99 GO-3310000

Western Pacific PRO1000 SMS Breathable Coveralls

- Fabricated out of breathable SMS material.
- Provides a substantial comfort level for the wearer in hot climates, however because of the breathability of the material it should not be used in an environment with airborne particulates or fiberglass fibers.
- 60 Gm material weight.
- Full hood, cuffs and ankles with elastic.
- Breast and rear pockets.
- Two way zipper - makes pit stops easy.
- Storm flap on two way zipper.
- Ankle zippers - makes boot entry easy and quick.
- Elastic waist for more flexibility.



Order No.	Mfg. No. / Description	List Price
440485	(41021) Large	\$9.39 HO-3650000
440486	(41022) X Large	\$9.39 HO-3650000
440488	(41023) XX Large	\$10.79 HO-7460000

Western Pacific PRO3000 Full Barrier Microporous Coveralls

- A full barrier model fabricated out of microporous materials.
- Will protect against airborne particulates as well as fiberglass fibers.
- 60 Gm material weight.
- Full hood, cuffs and ankles with elastic.
- Breast and rear pockets.
- Two way zipper - makes pit stops easy.
- Storm flap on two way zipper.
- Ankle zippers - makes boot entry easy and quick.
- Elastic waist for more flexibility.



Order No.	Mfg. No. / Description	List Price
440470	(43000) Large	\$9.49 HO-9650000
440482	(43001) X Large	\$9.49 HO-9650000
440483	(43002) XX Large	\$10.39 HO-3260000

3M Marine Disposable Protective Coverall Safety Work Wear

- Protective coverall helps protect against certain light liquid splashes and hazardous dusts.
- Lightweight, breathable material helps keep workers cool and comfortable.
- Extra room in arms and legs allow for free movement on the job.
- Seamless shoulders and sleeve tops help provide increased comfort and fewer potential entry points for contaminants.
- Meets government standards for Type 6 Splashes, Type 5 Dust, Anti-Static and Nuclear protection.
- Three panel hood design helps provide a more comfortable fit and a sleek, low-profile style.
- Does not contain components made from natural rubber latex to help prevent reactions from users with latex sensitivities or restrictions.



Order No.	Mfg. No. / Description	List Price
854303	(63264) Large	\$6.39 FO-7440000
854305	(63266) X Large	\$6.39 FO-7440000
854307	(63267) XX Large	\$6.79 FO-5740000
854308	(63268) XXX Large	\$7.19 FO-3050000

Western Pacific Boot Covers

- Constructed out of 60 Gm PP/PE coated fabric.
- Extra large entry opening for workman's boots.
- Secure elastic upper with a mid point elastic to provide additional security.
- Sold per pair per bag.



Order No.	Mfg. No. / Description	List Price
440604	(40035)	\$4.59 HO-5720000

Western Pacific Shoe Covers

- Constructed out of 60 Gm heavy duty with secure elastic upper.
- Sold per pair per bag.

Order No.	Mfg. No. / Description	List Price
440600	(40036) Large	\$3.99 HO-9320000



Western Pacific Spray Sock

- Offers a full four way stretch for maximum comfort and protection.
- The extra long neck insures security for the wearer.
- Finished edges and the soft hand of the material.
- One size fits all.



Order No.	Mfg. No. / Description	List Price
440605	(40040)	\$1.79 HO-7010000

SAS Thickster® Powdered Latex Gloves

- Powdered latex.
- 12" length for added protection.
- Beaded cuff for easy donning.
- Fully textured for superior grip.
- Strong yet soft and flexible.
- Thickness: 14 mil.
- Box of 50.



Order No.	Mfg. No. / Description	List Price
440616	(6604) X Large	\$55.69 HO-1433000

SAS Value-Touch® Powdered Latex Gloves

- Powdered latex.
- Stretches and conforms for superior fit and feel.
- Excellent touch sensitivity.
- Economical latex protection.
- Thickness: 5 mil.
- Box of 100.



Order No.	Mfg. No. / Description	List Price
440608	(6593) Large	\$20.69 HO-1421000
440610	(6594) X Large	\$20.69 HO-1421000

White Thermal Undergarments - 25#



- White thermal undergarments are what make up this wiper.
- This product is a soft and absorbent wiper.

Order No.	Description	List Price
211362	White Thermal Undergarments - 25#	\$46.49 FO-4523000

White Knit Rags - 100% Cotton



Order No.	Description	List Price
211800	(NWK10/UPGRAD) 10 lbs. Box	\$35.09 FO-6542000
211805	(NWK50/UPGRAD) 50 lbs. Box	\$175.29 FO-0722100

SAS Raven® Powder-Free Nitrile Gloves

- Powder-free exam grade nitrile.
- Non-latex.
- Outstanding strength, wear and dexterity.
- Textured for enhanced gripping power.
- Passes ASTM D6978 to handle Fentanyl substances.
- Thickness: 6 mil.
- Box of 100.



Order No.	Mfg. No. / Description	List Price
440607	(66518) Large	\$36.29 HO-7712000
440611	(66519) X Large	\$36.29 HO-7712000

White Sheeting - 25#



- This material is lint-free, soft and absorbent.
- Made from cut up bed linens and pillow cases, this is a great wiper when you are concerned about leaving lint behind.

Order No.	Description	List Price
210550	White Sheeting - 25#	\$57.89 FO-2504000

Color Sweatshirt - 25#



- This material is soft, very durable and economical.
- Made of recycled color sweatshirt material.
- This is a very popular wiper.

Order No.	Description	List Price
211350	Color Sweatshirt - 25#	\$21.49 FO-4051000

White Thermal Blankets - 100% Cotton



Order No.	Description	List Price
211810	(WTB10) 10 lbs. Box	\$32.79 FO-5922000
211815	(WTB50) 50 lbs. Box	\$163.69 FO-8541100

- Electronics
- Trolling Motors
- Instruments
- Electrical
- Lighting
- Anchor & Dock
- Safety
- Steering, Controls
- Pumps
- Fuel System
- Seating & Pedestals
- Trailering
- Tops & Covers
- Perform.
- Propellers
- Engine & Care
- Cleaning & Care
- Paint & Paint Acc.
- Fun & Flotation
- Topside Acc.
- Cockpit & Deck
- Hardware, Fasteners
- Camouflage
- Misc.
- Comm.



Western Pacific Bronze Wool Pads



- Rust resistant, use it for prepping any surface to be dressed or painted.
- Resist shedding and corrosion and won't leave behind rust-prone fibers.
- Use to polish chrome, brass and stainless steel.
- Sold 3 pads per poly pack.

Order No.	Description	List Price	
412356	Fine	\$10.39	HO-3260000
412368	Medium	\$9.69	HO-1850000
412370	Coarse	\$10.39	HO-3260000

Trimaco Aqua Shield™ Ultimate Surface Protection



- Ultimate Surface Protection, in a lighter color to reduce heat transfer in prolonged outdoor applications.
- This durable surface protector is slip resistance, fire retardant and waterproof.
- The best solution for covering any surface during the manufacturing, refurbish and repair processes.
- Competitively priced to save you money vs. competitive brands.

Order No.	Mfg. No. / Description	List Price	
887010	(87010) 10 mil, 36" x 100'	\$563.09	GO-7277300

Marpro Plastic Paint and Epoxy Mixing Tubs



Order No.	Description	List Price	
639302	8 oz.	\$0.69	E0-2500000
639306	16 oz.	\$0.59	E0-4400000
639317	32 oz.	\$0.79	E0-9500000
639320	85 oz.	\$1.59	E0-9110000
639332	5 Quarts	\$2.89	E0-7120000
7-9166	Plastic Lid for 639332 - 5 Quarts	\$2.19	GO-7410000

3M Marine All Purpose Tack Cloth



- Excellent for cleanup just before painting.
- Use to remove dirt, lint, dust and sanding particles from metal, plastic, fiberglass and wood.
- Use again and again.
- Stays soft. Non-toxic.
- Dimensions: 17" x 36".
- Sold one per pack.

Order No.	Mfg. No. / Description	List Price	
857170	(03192)	\$1.89	FO-2310000

Pettit Paint Strainers

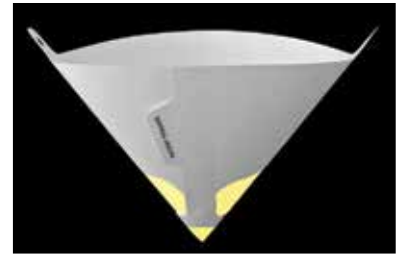

- Sold 250 strainer per box.

Order No.	Mfg. No. / Description	List Price	
736402	(14020-250)	\$89.69	E0-7276000

Plastic Pail and Lid



- Bucket with wire handle.
- Capacity: 5.7 gallon.

Order No.	Mfg. No. / Description	List Price	
639344	(250001) Pail Only	\$6.79	E0-9050000
639356	(201007) Lid Only	\$4.49	E0-7330000

**SPECIAL HANDLING MAY APPLY**

- Electronics
- Trolling Motors
- Instruments
- Electrical
- Lighting
- Anchor & Dock
- Safety
- Steering, Controls
- Pumps
- Fuel System
- Seating & Pedestals
- Trailering
- Tops & Covers
- Perform.
- Propellers
- Engine & Care
- Cleaning & Care
- Paint & Paint Acc.
- Fun & Flotation
- Topside Acc.
- Cockpit & Deck
- Hardware, Fasteners
- Camouflage
- Misc.
- Comm.



Western Pacific Stainless Steel Putty Knives



- High quality stainless steel blades with Sure Grip cushion handle.

STIFF BLADE

Order No.	Mfg. No. / Description	List Price
570641	(32005) 2"	\$5.69 HO-1430000

FLEX BLADE

Order No.	Mfg. No. / Description	List Price
570656	(32004) 1-1/2"	\$5.29 HO-7130000
570657	(32006) 2"	\$5.69 HO-1430000
570653	(32010) 2-1/2"	\$5.99 HO-9530000
570658	(32014) 3"	\$6.39 HO-3830000

Swobbit ScrapeRite Plastic Razor Blade



- Hot injected molded plastic razor blades designed with two sharp edges used for scraping, cleaning and peeling.
- They are non-metallic and non-magnetic so they will never rust or corrode.
- General purpose (orange blade). Softest material, very pliable and forgiving, for use on delicate surfaces.
- Package includes 5 blades and one holder.

Order No.	Mfg. No. / Description	List Price
570716	(SR5GPOE)	\$5.79 FO-5040000

Metal Scraper



- 1" x 15" double end scraper.
- Fine grade tool steel, heat treated.

Order No.	Mfg. No. / Description	List Price
532893	(103-393)	\$10.59 E0-4970000

Western Pacific Stainless Steel Angle Blade Scraper



- Stainless steel blade with Sure Grip cushion handle.
- 3" angle blade scraper.

Order No.	Mfg. No. / Description	List Price
570603	(32040)	\$6.49 HO-9830000

Western Pacific Stainless Steel ProPainter Tool



- 3-1/2" stainless steel 5 in 1 ProPainter Tool with Sure Grip cushion handle.

Order No.	Mfg. No. / Description	List Price
570704	(32075)	\$7.19 HO-1340000

Western Pacific Window Scraper



- Poly carbon case - non-rusting.
- Locking single edge blade.
- Easy blade replacement.

Order No.	Mfg. No. / Description	List Price
570665	(32060) Window Scraper	\$1.19 HO-1700000
440824	(100104) Repl. Blades, Box of 100	\$14.89 DO-1911000

Western Pacific Utility Knife



- 4-position retractable blade.
- 3 extra blades in handle.
- Ideal for drywall, industrial and general use.

Order No.	Mfg. No. / Description	List Price
570689	(32065) Utility Knife	\$4.29 HO-7520000
570691	(32070) Repl. Blades, Pack of 5	\$1.59 HO-5900000

Chipping and Scaling Hammer



- Hardened steel chisel and cross chisel.
- Wood handle.

Order No.	Mfg. No. / Description	List Price
210601	(CH)	\$20.59 HO-5321000

- Electronics
- Trolling Motors
- Instruments
- Electrical
- Lighting
- Anchor & Dock
- Safety
- Steering, Controls
- Pumps
- Fuel System
- Seating & Pedestals
- Trailering
- Tops & Covers
- Perform.
- Propellers
- Engine & Care
- Cleaning & Care
- Paint & Paint Acc.
- Fun & Flotation
- Topside Acc.
- Cockpit & Deck
- Hardware, Fasteners
- Camouflage
- Misc.
- Comm.



## 3M Quick Reference Guide



	DMI #	3M #	DESCRIPTION	PAGE #
	<b>HAND MASKER</b>			
	855859	95255	Hand Masker™ Pre-Folded Masking Film, 24" x 180'	1174
	855873	90038	Hand Masker™ Pre-Folded Masking Film, 48" x 180'	1174
	855897	90039	Hand Masker™ Pre-Folded Masking Film, 72" x 90'	1174
	855899	90040	Hand Masker™ Pre-Folded Masking Film, 99" x 90'	1174
Electronics	855772	06904	Hand Masker™ Premium Quality Masking Paper, 18" x 60 yds.	1174
Trolling Motors	855900	051141-34065	Hand Masker™ Pre-Taped Plastic Drop Cloth, 24" x 30 yds.	1174
	855901	051141-34067	Hand Masker™ Pre-Taped Plastic Drop Cloth, 48" x 25 yds.	1174
Instruments	<b>SCOTCHBLUE ORIGINAL MULTI-SURFACE MASKING TAPE - 2090</b>			
	855481	03680	Scotch Long-Mask Masking Tape - 2090 (Bright Blue Color), 3/4" x 60 yds.	1172
Electrical	855493	051115-09171	Scotch Long-Mask Masking Tape - 2090 (Bright Blue Color), 1" x 60 yds.	1172
	855506	051115-09221	Scotch Long-Mask Masking Tape - 2090 (Bright Blue Color), 1-1/2" x 60 yds.	1172
Lighting	855518	051115-09168	Scotch Long-Mask Masking Tape - 2090 (Bright Blue Color), 2" x 60 yds.	1172
Anchor & Dock	<b>SCOTCH DELICATE SURFACE PAINTER'S MASKING TAPE - 2080</b>			
	855532	79750	Scotch Safe-Release Painters Masking Tape - 2080, 1" x 60 yds.	1172
	855520	79748	Scotch Safe-Release Painters Masking Tape - 2080, 2" x 60 yds.	1172
Safety	<b>SCOTCH PERFORMANCE GREEN MASKING TAPE - 233+</b>			
Steering, Controls	855179	26334	Scotch Performance Green Masking Tape - 233+, 3/4" x 60 yds.	1173
	855178	26336	Scotch Performance Green Masking Tape - 233+, 1" x 60 yds.	1173
	855177	26338	Scotch Performance Green Masking Tape - 233+, 1-1/2" x 60 yds.	1173
Pumps	855140	26340	Scotch Performance Green Masking Tape - 233+, 2" x 60 yds.	1173
Fuel System	<b>TAN TAPE</b>			
	855320	06544	Highland™ Masking Tape - 2727, 1" x 60 yds.	1173
	855322	06543	Highland™ Masking Tape - 2727, 1-7/8" x 60 yds.	1173
Seating & Pedestals	855203	02992	Scotch Solvent Resistant Masking Tape - 2040, 1" x 60 yds.	1172
	855215	02993	Scotch Solvent Resistant Masking Tape - 2040, 1-1/2" x 60 yds.	1172
Trailer	855239	04365	Scotch Solvent Resistant Masking Tape - 2040, 2" x 60 yds.	1172
Tops & Covers	855126	05617	Scotch Masking Tape - 2050, 3/4" x 60 yds.	1172
	855138	05618	Scotch Masking Tape - 2050, 1" x 60 yds.	1172
	855164	021200-05620	Scotch Masking Tape - 2050, 31-7/8" x 60 yds.	1172
Perform.	<b>VINYL FINE LINE TAPE</b>			
Propellers	855330	06301	Scotch Fine Line Tape - 218, 1/4" x 60 yds.	1173
	855227	04698	Scotch Fine Line Tape - 218, 1/2" x 60 yds.	1173
Engine & Care	855378	04699	Scotch Fine Line Tape - 218, 3/4" x 60 yds.	1173
	855380	04700	Scotch Fine Line Tape - 218, 1" x 60 yds.	1173
Cleaning & Care	855675	31842	Outdoor Masking Poly Tape - 5903, 1-7/8" x 60 yds.	1173
Paint & Paint Acc.	855410	62334	Preservation Sealing Tape - 4811, 2" x 36 yds.	1038, 1169
	855657	91765	Scotch Shipping Packaging Tape - 3750, 1-7/8" x 60 yds.	1173
	855633	051131-88619	Scotchlite Reflective Material - SOLAS, 2" x 54.6 yds.	415
Fun & Flotation	<b>ELECTRICAL TAPE</b>			
	512168	93604	Tartan General use Vinyl Electrical Tape, 3/4" x 66'	188
Topside Acc.	857423	16720	Highland Vinyl Plastic Electrical Tape, 3/4" x 66'	188
Cockpit & Deck	857447	10810	Scotch Vinyl Color Coding Electrical Tape - 35, 3/4" x 66' (Red)	188
	857450	10828	Scotch Vinyl Color Coding Electrical Tape - 35, 3/4" x 66' (White)	188
Hardware, Fasteners	857435	06133	Scotch Super 33+ Premium Vinyl Electrical Tape - 3/4" x 52'	188
Camouflage				
Misc.				
Comm.				





## 3M Quick Reference Guide



DMI #	3M #	DESCRIPTION	PAGE #
<b>STIKIT BACK UP PADS</b>			
853210	05646	Stikit Dust Free Low Profile Finishing Disc Pad, 6" Diameter	1155
853209	45218	Stikit Dust Free Pad, 6" Diameter	1155
<b>STIKIT BACK UP PADS</b>			
853204	05555	Stikit Low Profile Disc Pad, 5" Diameter	1152
2012267	11063	Stikit Disc Hand Pad, 5" x 1"	1156
<b>STIKIT GREEN ABRASIVES</b>			
852980	01547	Green Corps Stikit Production Discs - 40E Grade, 6" Diameter	1154
852992	01548	Green Corps Stikit Production Discs - 36E Grade, 6" Diameter	1154
886361	55540	Stikit Paper Disc Rolls (236U) - P80 Grade, 5" Diameter	1152
886385	55542	Stikit Paper Disc Rolls (236U) - P120 Grade, 5" Diameter	1152
886388	55545	Stikit Paper Disc Rolls (236U) - P220 Grade, 5" Diameter	1152
886397	55547	Stikit Paper Disc Rolls (236U) - P320 Grade, 5" Diameter	1152
<b>STIKIT GOLD ABRASIVES</b>			
852841	55560	Stikit Paper Disc Rolls (236U) - P80 Grade, 6" Diameter	1155
852839	55561	Stikit Paper Disc Rolls (236U) - P100 Grade, 6" Diameter	1155
852827	55562	Stikit Paper Disc Rolls (236U) - P120 Grade, 6" Diameter	1155
852815	55563	Stikit Paper Disc Rolls (236U) - P150 Grade, 6" Diameter	1155
852803	55564	Stikit Paper Disc Rolls (236U) - P180 Grade, 6" Diameter	1155
852790	55565	Stikit Paper Disc Rolls (236U) - P220 Grade, 6" Diameter	1155
852764	55567	Stikit Paper Disc Rolls (236U) - P320 Grade, 6" Diameter	1155
852776	55568	Stikit Paper Disc Rolls (236U) - P400 Grade, 6" Diameter	1155
852788	55569	Stikit Paper Disc Rolls (236U) - P500 Grade, 6" Diameter	1155
<b>STIKIT WHITE ABRASIVES</b>			
852634	01318	Stikit Finishing Film Discs - P1200 Grade, 6" Diameter	1154
852635	01319	Stikit Finishing Film Discs - P1000 Grade, 6" Diameter	1154
852636	01320	Stikit Finishing Film Discs - P800 Grade, 6" Diameter	1154
852637	01321	Stikit Finishing Film Discs - P600 Grade, 6" Diameter	1154
<b>STIKIT GOLD ABRASIVES "F" WEIGHT</b>			
852924	21791	Stikit Paper Disc Rolls (363I) - 60F Grade, 6" Diameter	1154
852928	21793	Stikit Paper Disc Rolls (363I) - 80F Grade, 6" Diameter	1154
852930	21794	Stikit Paper Disc Rolls (363I) - P120F Grade, 6" Diameter	1154
<b>STIKIT SANDING BLOCKS</b>			
854756	05441	Stikit Hand Block, 2-3/4" x 7-3/4"	1160
854744	05442	Stikit Soft Hand Block, 2-3/4" x 5"	1160
854732	05519	Rubber Sanding Block, 2-3/4" x 5"	1160
<b>STIKIT GOLD ABRASIVES ROLLS</b>			
852560	02590	Stikit Gold Sheet Roll - P400 Grade, 2-3/4" Width	1159
852561	02591	Stikit Gold Sheet Roll - P320 Grade, 2-3/4" Width	1159
852563	02594	Stikit Gold Sheet Roll - P220 Grade, 2-3/4" Width	1159
852564	02595	Stikit Gold Sheet Roll - P180 Grade, 2-3/4" Width	1159
852565	02596	Stikit Gold Sheet Roll - P150 Grade, 2-3/4" Width	1159
852566	02597	Stikit Gold Sheet Roll - P120 Grade, 2-3/4" Width	1159
852568	02599	Stikit Gold Sheet Roll - P80 Grade, 2-3/4" Width	1159
<b>STIKIT BACK UP PADS</b>			
853215	05568	Stikit Disc Pad, Soft - 8" Diameter	1157
853211	05579	Stikit Disc Pad, Medium - 8" Diameter	1157
<b>STIKIT GREEN ABRASIVES</b>			
853021	01549	Stikit Green Corps Production Disc - 80D Grade, 8" Diameter	1156
853071	01556	Stikit Green Corps Production Disc - 60E Grade, 8" Diameter	1156
853007	01550	Stikit Green Corps Production Disc - 40E Grade, 8" Diameter	1156
853019	01551	Stikit Green Corps Production Disc - 36E Grade, 8" Diameter	1156
853057	01552	Stikit Green Corps Production Disc - 24E Grade, 8" Diameter	1156

- Electronics
- Trolling Motors
- Instruments
- Electrical
- Lighting
- Anchor & Dock
- Safety
- Steering, Controls
- Pumps
- Fuel System
- Seating & Pedestals
- Trailering
- Tops & Covers
- Perform.
- Propellers
- Engine & Care
- Cleaning & Care
- Paint & Paint Acc.
- Fun & Flotation
- Topside Acc.
- Cockpit & Deck
- Hardware, Fasteners
- Camouflage
- Misc.
- Comm.



3M Quick Reference Guide



DMI #	3M #	DESCRIPTION	PAGE #
<b>STIKIT GOLD ABRASIVES</b>			
852891	21785	Stikit Paper Disc Rolls - P120F Grade, 8" Diameter	1156
852905	21787	Stikit Paper Disc Rolls - 80F Grade, 8" Diameter	1156
852916	21788	Stikit Paper Disc Rolls - 60F Grade, 8" Diameter	1156
<b>HOOKIT BACK UP PADS</b>			
853174	051141-20356	Hookit Clean Sanding Low Profile Disc Pad - Firm (Red Foam), 6" Diameter	1155
853182	05777	Hookit Soft Interface Pad, 6" Diameter	1155
853176	20425	Hookit Clean Sanding Low Profile Disc Pad - Soft (Beige Foam), 6" Diameter	1155
<b>HOOKIT GOLD ABRASIVES</b>			
887031	55598	Hookit Clean Sanding Disc (236U) - P80 Grade, 5" Diameter	1152
887036	55501	Hookit Clean Sanding Disc (236U) - P200 Grade, 5" Diameter	1152
887038	55503	Hookit Clean Sanding Disc (236U) - P320 Grade, 5" Diameter	1152
887039	55504	Hookit Clean Sanding Disc (236U) - P400 Grade, 5" Diameter	1152
<b>HOOKIT GOLD ABRASIVES</b>			
887045	55506	Hookit Clean Sanding Disc - P80 Grade, 6" Diameter	1154
887047	55508	Hookit Clean Sanding Disc - P120 Grade, 6" Diameter	1154
887049	55510	Hookit Clean Sanding Disc - P180 Grade, 6" Diameter	1154
887050	55511	Hookit Clean Sanding Disc - P220 Grade, 6" Diameter	1154
887052	55513	Hookit Clean Sanding Disc - P320 Grade, 6" Diameter	1154
<b>HOOKIT PURPLE ABRASIVES</b>			
2012276	30787	Purple Hookit Abrasive Disc - 36E Grade, 6" Diameter	1153
886052	31370	Cubitron II Hookit Clean Sanding Disc - 40+ Grade, 6" Diameter	1153
886050	31379	Cubitron II Hookit Clean Sanding Disc -80+ Grade, 6" Diameter	1153
886054	31372	Cubitron II Hookit Clean Sanding Disc -120+ Grade, 6" Diameter	1153
887060	31371	Hookit Purple Clean Sanding Disc - P80 Grade, 6" Diameter	1153
887064	31374	Hookit Purple Clean Sanding Disc - P180 Grade, 6" Diameter	1153
887066	31481	Hookit Purple Clean Sanding Disc - P220 Grade, 6" Diameter	1153
887068	01812	Hookit Purple Clean Sanding Disc - P320 Grade, 6" Diameter	1153
887070	01811	Hookit Purple Clean Sanding Disc - P400 Grade, 6" Diameter	1153
<b>HOOKIT WHITE/PURPLE ABRASIVE FILM</b>			
852670	30667	Hookit Purple Finishing Film Disc - P1500 Grade, 6" Diameter	1153
852672	30668	Hookit Purple Finishing Film Disc - P1200 Grade, 6" Diameter	1153
852674	30669	Hookit Purple Finishing Film Disc - P1000 Grade, 6" Diameter	1153
<b>HOOKIT FLEXIBLE ABRASIVE DISCS</b>			
852676	34405	Hookit Flexible Abrasive Disc - P600 Grade, 6" Diameter	1153
852678	34406	Hookit Flexible Abrasive Disc - P800 Grade, 6" Diameter	1153
852680	34407	Hookit Flexible Abrasive Disc - P1000 Grade, 6" Diameter	1153
852682	34409	Hookit Flexible Abrasive Disc - P1500 Grade, 6" Diameter	1153
852660	02085	Trizact Hookit Foam Disc - P3000 Grade, 6" Diameter	1153
<b>HOOKIT BACK UP PAD</b>			
854097	05768	Hookit Disc Pad - Soft, 8" Diameter	1157
<b>WET OR DRY ABRASIVES</b>			
854225	02000	Wetordry Tri-M-ite Sheet - 600A Grade (A Weight), 9" x 11"	1159
854237	02002	Wetordry Tri-M-ite Sheet - 400A Grade (A Weight), 9" x 11"	1159
854251	02004	Wetordry Tri-M-ite Sheet - 320A Grade (A Weight), 9" x 11"	1159
854275	02007	Wetordry Tri-M-ite Sheet - 220A Grade (A Weight), 9" x 11"	1159
854124	02014	Wetordry Tri-M-ite Sheet - 180C Grade (C Weight), 9" x 11"	1159
854148	02016	Wetordry Tri-M-ite Sheet - 120C Grade (C Weight), 9" x 11"	1159
854150	02017	Wetordry Tri-M-ite Sheet - 100C Grade (C Weight), 9" x 11"	1159
854162	02018	Wetordry Tri-M-ite Sheet - 80C Grade (C Weight), 9" x 11"	1159
854174	24001	Wetordry Tri-M-ite Sheet - 60C Grade (C Weight), 9" x 11"	1159

## 3M Quick Reference Guide



DMI #	3M #	DESCRIPTION	PAGE #
<b>WET OR DRY ABRASIVES</b>			
854200	02044	Wetordry Sheet - 2000 Grade, 5-1/2" x 9"	1159
854186	02021	Wetordry Sheet - 1000 Grade, 5-1/2" x 9"	1159
854198	02022	Wetordry Sheet - 1200 Grade, 5-1/2" x 9"	1159
854201	02023	Wetordry Sheet - 1500 Grade, 5-1/2" x 9"	1159
854204	02034	Wetordry Sheet - 1000 Grade, 5-1/2" x 9"	1159
<b>9" x 11" DRY SHEETS</b>			
854390	02115	Production Sheet - 80D Grade, 9" x 11"	1159
<b>ROLOCS</b>			
886910	28547	Pistol Grip Disc Sander - Tool Diameter: 3"	1158
853111	05539	Roloc Disc Pad Assembly - Diameter 2"	1158
853110	05540	Roloc Disc Pad Assembly - Diameter 3"	1158
853085	01397	Green Corps Roloc Disc - 36 Grade, Diameter 2"	1158
853083	01406	Green Corps Roloc Disc - 50 Grade, Diameter 3"	1158
853095	01407	Green Corps Roloc Disc - 36 Grade, Diameter 3"	1158
853108	01408	Green Corps Roloc Disc - 24 Grade, Diameter 3"	1158
853120	33377	Cubitron™ II Fibre Roloc Disc - 36+ Grade, Diameter 2"	1158
853123	33379	Cubitron™ II Fibre Roloc Disc - 60+ Grade, Diameter 2"	1158
853125	33380	Cubitron™ II Fibre Roloc Disc - 80+ Grade, Diameter 2"	1158
853130	33389	Cubitron™ II Fibre Roloc Disc - 36+ Grade, Diameter 3"	1158
853133	33391	Cubitron™ II Fibre Roloc Disc - 60+ Grade, Diameter 3"	1158
855105	07480	Scotch-Brite Roloc Surface Conditioning Disc - Coarse, Diameter 2"	1158
855106	07481	Scotch-Brite Roloc Surface Conditioning Disc - Medium, Diameter 2"	1158
853080	07485	Scotch-Brite Roloc Surface Conditioning Disc - Coarse, Diameter 3"	1158
853081	07486	Scotch-Brite Roloc Surface Conditioning Disc - Medium, Diameter 3"	1158
<b>EMORY CLOTH</b>			
855001	05002	Three-M-ite Elek-Tro-Cut Cloth Utility Roll - 320 Grade, 1" W x 50 yds.	1161
855037	05006	Three-M-ite Elek-Tro-Cut Cloth Utility Roll - 180 Grade, 1" W x 50 yds.	1161
855051	05010	Three-M-ite Elek-Tro-Cut Cloth Utility Roll - 80 Grade, 1" W x 50 yds.	1161
<b>GRINDING DISCS</b>			
854776	01914	Green Corps Fibre Disc - 36 Grade, 5" x 7/8"	1158
854778	01915	Green Corps Fibre Disc - 24 Grade, 5" x 7/8"	1158
<b>SCOTCH-BRITE PADS</b>			
855099	051131-07447	Scotch-Brite™ General Purpose Hand Pad, 6" x 9"	1161
855087	07445	Scotch-Brite™ Light Duty Cleansing Pad, 6" x 9"	1161
855102	07448	Scotch-Brite™ Ultra Fine Hand Pad, 6" x 9"	1161
855080	08293	Scotch-Brite™ General Purpose Scouring Pad, 6" x 9"	1160
857095	08542	Doodlebug™ Pad Holder with Pads	1008
857097	08003	Doodlebug™ White Cleaning Pad	1008
857098	08004	Doodlebug™ Brown Scrub 'N Strip Pad	1008
857096	08005	Doodlebug™ Blue Scrub Pad	1008
<b>SANDERS</b>			
886905	20327	Random Orbital Sander with Self-Generated Vacuum - 6"	1157
886929	20452	Filter Bag for Orbital Sanders - Large	1157
854999	77927	Cloth Belt (777F) - 40 Grade	1161
854998	88873	PSA Cloth Disc (777F) - 40 Grade, Diameter 12"	1157

Electronics

Trolling Motors

Instruments

Electrical

Lighting

Anchor &amp; Dock

Safety

Steering, Controls

Pumps

Fuel System

Seating &amp; Pedestals

Trailering

Tops &amp; Covers

Perform.

Propellers

Engine &amp; Care

Cleaning &amp; Care

Paint &amp; Paint Acc.

Fun &amp; Flotation

Topside Acc.

Cockpit &amp; Deck

Hardware, Fasteners

Camouflage

Misc.

Comm.





3M Quick Reference Guide



Paint & Paint Acc.

- Electronics
- Trolling Motors
- Instruments
- Electrical
- Lighting
- Anchor & Dock
- Safety
- Steering, Controls
- Pumps
- Fuel System
- Seating & Pedestals
- Trailering
- Tops & Covers
- Perform.
- Propellers
- Engine & Care
- Cleaning & Care
- Paint & Paint Acc.
- Fun & Flotation
- Topside Acc.
- Cockpit & Deck
- Hardware, Fasteners
- Camouflage
- Misc.
- Comm.

DMI #	3M #	DESCRIPTION	PAGE #
<b>PPS/ACCUSPRAY</b>			
886793	16580	Accuspray™ ONE Spray Gun System with Standard PPS™	1133
886795	16578	Accuspray™ ONE Spray Gun Kit	1133
886762	16000	PPS™ Kit - Standard Size	1134
886763	16001	PPS™ Mixing Cup and Collar - Standard, 22 oz.	1134
886789	16023	PPS™ Mixing Cup and Collar - Large, 28 oz.	1134
886791	16024	PPS™ Kit - Large Size	1134
886769	051131-16115	PPS™ Mixing Cup and Collar - Mini, 6 oz.	1134
886767	16114	PPS™ Kit - Mini Size	1134
886803	16587	Accuspray™ HGP Spray Gun Kit	1133
886772	16121	PPS™ Type H/O Pressure Cup, 6 oz.	1134
886796	16609	Accuspray™ Atomizing Head - 2.0 mm	1133
886797	16611	Accuspray™ Atomizing Head - 1.8 mm	1133
886794	16612	Accuspray™ Atomizing Head - 1.4 mm	1133
857170	03192	All Purpose Tack Cloth	1139
<b>COMPOUNDS/POLISHES</b>			
857175	09004	Rubbing Compound - Pint	982
857168	09005	Restorer and Wax - Pint	983
857182	09006	Restorer and Wax - Quart	983
857194	09007	Restorer and Wax - Gallon	983
857233	09009	Cleaner and Wax - Pint	983
857245	09010	Cleaner and Wax - Quart	983
857257	09011	Cleaner and Wax - Gallon	983
857260	09089	Color/Gloss Restorer	982
857176	09048	Finesse-It™ II Glaze	982
857375	09061	Scotchgard™ Marine Liquid Wax - Pint	983
857376	09062	Scotchgard™ Marine Liquid Wax - Liter	983
857284	09019	Metal Restorer and Polish - 18 oz.	986
857269	09020	Aluminum Restorer and Polish - 18 oz.	986
857295	09023	Vinyl Cleaner, Conditioner and Protector - 8.4 fl. oz.	986
857373	09033	Clean and Shine Wax - Pint	983
857156	09065	Mildew Block - Pint	986
857159	09067	Mildew Stain Remover - Pint	986
857296	16904	Vinyl Conditioner and Restorer - Pint	986
<b>GELCOAT FINISHING</b>			
857396	09034	Perfect-It™ Boat Wash - Pint	982
856991	36101	Perfect-It™ Gelcoat Heavy Cutting Compound - Pint	982
856992	36102	Perfect-It™ Gelcoat Heavy Cutting Compound - Quart	982
856994	36103	Perfect-It™ Gelcoat Heavy Cutting Compound - Gallon	982
856998	36105	Perfect-It™ Medium Cutting Compound + Wax - Pint	982
857000	36106	Perfect-It™ Medium Cutting Compound + Wax - Quart	982
857004	36109	Perfect-It™ Gelcoat Light Cutting Polish + Wax - Pint	983
857006	36110	Perfect-It™ Gelcoat Light Cutting Polish + Wax - Quart	983
857010	36112	Perfect-It™ Boat Wax - Pint	983
857012	36113	Perfect-It™ Boat Wax - Quart	983
856863	05954	Super Duty Rubbing Compound - Quart	982
856875	05955	Super Duty Rubbing Compound - Gallon	982
856890	06025	High Gloss Gelcoat Compound - Gallon	983
856899	06044	Compound and Finishing Material - Quart	982
856901	06045	Compound and Finishing Material - Gallon	982
856952	35928	Finesse-It™ II Glaze - Quart	982
856926	06039	Finesse-It™ Marine Paste Compound - Gallon	983



## 3M Quick Reference Guide



DMI #	3M #	DESCRIPTION	PAGE #
<b>PAINT FINISHING</b>			
856964	36060	Perfect-It™ EX AC Rubbing Compound - Quart	982
856967	36061	Perfect-It™ EX AC Rubbing Compound - Gallon	982
856887	06085	Perfect-It™ Rubbing Compound - Quart	982
856935	06068	Perfect-It™ EX Ultrafine Machine Polish - Quart	983
7001548	16861	Sharpshooter™ No-Rinse Mark Remover - Quart	986
<b>BUFF PADS</b>			
857085	81470	Finesse-It™ Natural Buffing Pad - Diameter 3"	1000
857087	33280	Wool Compounding Pad - Diameter 9"	1000
857089	33282	Wool Polishing Pad, Double Sided - Diameter 9"	1001
<b>BUFF PADS - DOUBLE SIDED - SCREW ON</b>			
857135	05710	Screw On Buffing Pad Adaptor	1001
857069	05703	100% Wool Compounding Pad - Diameter 9"	1001
857071	05704	Wool Blend Compounding Pad - Diameter 9"	1001
857079	05705	Wool Polishing Pad - Diameter 9"	1001
<b>BUFF PADS - SINGLE SIDED - HOOK AND LOOP</b>			
857120	05717	Hookit™ Back-Up Pad - Diameter 7"	1001
857121	05718	Perfect-It™ Back-Up Pad - Diameter 7"	1001
857106	05711	Hookit™ 60:40 Wool Blend Compounding Pad - Diameter 9"	1000
857118	05713	Wool Polishing Pad - Diameter 9"	1001
857133	05725	Perfect-It™ Foam Polishing Pad - Diameter 8"	1000
<b>QUICK CONNECT PADS</b>			
857152	05752	Perfect-It™ Quick Connect Adapter	1001
857153	05753	Perfect-It™ Wool Compounding Pad - Diameter 9"	1000
857154	05754	Perfect-It™ Wool Polishing Pad - Diameter 9"	1001
857080	05706	Perfect-It™ Foam Compounding Pad - Diameter 9"	1000
857103	05707	Perfect-It™ Foam Polishing Pad - Diameter 8"	1000
857104	05708	Perfect-It™ Ultrafine Foam Polishing Pad - Diameter 8"	1000
856885	06020	Perfect-It™ Detailing Cloth - Yellow	1010

Electronics

Trolling Motors

Instruments

Electrical

Lighting

Anchor &amp; Dock

Safety

Steering, Controls

Pumps

Fuel System

Seating &amp; Pedestals

Trailering

Tops &amp; Covers

Perform.

Propellers

Engine &amp; Care

Cleaning &amp; Care

Paint &amp; Paint Acc.

Fun &amp; Flotation

Topside Acc.

Cockpit &amp; Deck

Hardware, Fasteners

Camouflage

Misc.

Comm.



3M Quick Reference Guide



	DMI #	3M #	DESCRIPTION	PAGE #
<b>SILICONE</b>				
	856318	08017	Marine Grade Mildew Resistant Silicone Sealant - 3 oz. Tube, White	1025
	856332	08019	Marine Grade Mildew Resistant Silicone Sealant - 3 oz. Tube, Clear	1025
	856356	08027	Marine Grade Mildew Resistant Silicone Sealant - 10 oz. Cartridge, White	1025
	856370	08029	Marine Grade Mildew Resistant Silicone Sealant - 10 oz. Cartridge, Clear	1025
<b>ADHESIVE SEALANTS</b>				
Electronics				
Trolling Motors	856091	06500	Adhesive/Sealant 5200 - 10 oz. Cartridge, White	1025
	856104	06501	Adhesive/Sealant 5200 - 10 oz. Cartridge, Tan	1025
Instruments	856116	06502	Adhesive/Sealant 5200 - 10 oz. Cartridge, Mahogany	1025
	856130	06504	Adhesive/Sealant 5200 - 10 oz. Cartridge, Black	1025
	856027	05203	Adhesive/Sealant 5200 - 3 oz. Tube, White	1025
Electrical	856041	05205	Adhesive/Sealant 5200 - 3 oz. Tube, Black	1025
	856053	05206	Adhesive/Sealant 5200 - 1 oz. Tube, White	1025
Lighting	856003	21463	Adhesive/Sealant 5200 - 5 Gallon Pail, White	1025
	856136	06520	Adhesive/Sealant Fast Cure 5200 - 10 oz. Cartridge, White	1025
Anchor & Dock	856135	05220	Adhesive/Sealant Fast Cure 5200 - 3 oz. Tube, White	1025
	856134	06535	Adhesive/Sealant Fast Cure 5200 - 1 oz. Tube, White	1025
Safety	856142	06560	Adhesive/Sealant Fast Cure 4200 - 10 oz. Cartridge, White	1025
	856144	06564	Adhesive/Sealant Fast Cure 4200 - 10 oz. Cartridge, Black	1025
Steering, Controls	856140	05260	Adhesive/Sealant Fast Cure 54200 - 3 oz. Tube, White	1025
	856154	06580	Adhesive/Sealant Fast Cure 4000 UV - 10 oz. Cartridge, White	1025
Pumps	856153	05280	Adhesive/Sealant Fast Cure 4000 UV - 3 oz. Tube, White	1025
<b>SPRAY ADHESIVES</b>				
Fuel System	856537	21210	Super 77™ Multipurpose Spray Adhesive - 24 fl. oz.	1024
	856535	08090	Super Trim Spray Adhesive - 19 fl. oz.	1024
Seating & Pedestals	856536	38984	Specialty Adhesive Remover - Quart	1023
	856538	20272	Neoprene Contact Adhesive - Quart	1024
Trailering	856541	08984	General Purpose Adhesive Cleaner - Quart	1023
Tops & Covers	886688	06463	Dual Lock™ Reclosable Fastener System - Clear	1302
	886690	06484	Dual Lock™ Reclosable Fastener System - Black	1302
Perform.	856533	08001	Super Weatherstrip and Gasket Adhesive - 5 oz. Tube	1028
	856382	08672	Ultrapro™ High Temp Silicone Gasket - 3 oz. Tube	880, 1028
Propellers	<b>FILLERS</b>			
Engine & Care	856774	05095	Acryl-White Glazing Putty - 14.5 oz.	1012
	856748	05766	Blue Cream Hardener - 2.75 oz.	1014
	856736	05830	Red Cream Hardener - 2.75 oz.	1014
Cleaning & Care	852499	46004	Premium Filler - Pint	1013
	852500	46005	Premium Filler - Quart	1013
Paint & Paint Acc.	852512	46006	Premium Filler - Gallon	1013
	852548	46013	High Strength Repair Filler - Quart	1013
Fun & Flotation	852550	46014	High Strength Repair Filler - Gallon	1013
	856724	05801	Lightweight Body Filler - Gallon	1013
Topside Acc.	2012218	05842	Spreader - Size 4"	1016
Cockpit & Deck				
Hardware, Fasteners				
Camouflage				
Misc.				
Comm.				





## 3M Quick Reference Guide



DMI #	3M #	DESCRIPTION	PAGE #
<b>SAFETY</b>			
854303	63264	Disposable Protective Coverall Safety Work Wear - Large	1137
854305	63266	Disposable Protective Coverall Safety Work Wear - X Large	1137
854307	63267	Disposable Protective Coverall Safety Work Wear - XX Large	1137
854308	63268	Disposable Protective Coverall Safety Work Wear - XXX Large	1137
854330	64187	Hard Hat - Pinlock Suspension	423, 1163
854340	64197	Hard Hat - Ratchet Suspension	423, 1163
<b>DUST MASKS</b>			
856630	46457	8210, N95 Particulate Respirator	423, 1163
856550	54343	8511, N95 Particulate Respirator	423, 1163
856560	54141	8212, N95 Particulate Welding Respirator with Foam Face Seal	423, 1163
856572	54358	8247, R95 Particulate Respirator	423, 1163
<b>HALF MASK RESPIRATORS</b>			
856611	66069	Half Facepiece Disposable Respirator Assembly - Dual Cartridge, Medium	422, 1162
856623	66070	Half Facepiece Disposable Respirator Assembly - Dual Cartridge, Large	422, 1162
857044	07025	6000 Series Half Facepiece Respirator - Reusable, Medium	422, 1162
857046	07026	6000 Series Half Facepiece Respirator - Reusable, Large	422, 1162
857048	07178	Half Facepiece Disposable Respirator Assembly - Dual Cartridge, Medium (Packout)	422, 1162
857049	07179	Half Facepiece Disposable Respirator Assembly - Dual Cartridge, Large (Packout)	422, 1162
857051	37083	7500 Series Half Facepiece Respirator - Reusable, Large	422, 1162
<b>FULL FACE RESPIRATORS</b>			
857053	54146	6000 Series Full Facepiece Respirators - Reusable, Medium	422, 1162
857054	54159	6000 Series Full Facepiece Respirators - Reusable, Large	422, 1162
<b>CARTRIDGES</b>			
857041	21674	Organic Vapor Cartridge (6001)	422, 1162
857039	07047	Organic Vapor/Acid Gas Cartridge (6003)	422, 1162
854996	17668	Filter Retainer	422, 1162
856625	07194	Particulate Filter	422, 1162
854984	46464	Particulate Filter (5N11)	422, 1162
854287	54356	Particulate Filter (2071)	422, 1162
854299	07000	Particulate Filter (2091)	422, 1162
854300	07184	Particulate Filter with Nuisance Level Organic Vapor Relief	422, 1162
<b>PARTS/ACCESSORIES</b>			
856659	07065	Respirator Cleaning Wipes	423, 1163
856655	07142	Face Shield Cover (6885)	422, 1162
857035	37004	Nose Cup Assembly (6894)	422, 1162
<b>HEARING PROTECTION</b>			
856584	093045-08061	General Purpose Ear Muff	424
856596	29008	Ear Plugs	424
<b>EYE PROTECTION</b>			
856652	11815	Virtua™ Protective Eyewear - Gray Anti-Fog Lens, Temple	423
812506	11819	Virtua™ Protective Eyewear - Clear Anti-Fog Lens, Temple	423
856558	62137	Safety Impact Goggles	423
<b>OIL SORBENTS</b>			
852461	28991	Petroleum Sorbent Pad, Thickness 3/8"	999
852459	16050	Petroleum Sorbent Pad, Thickness 3/8"	999

- Electronics
- Trolling Motors
- Instruments
- Electrical
- Lighting
- Anchor & Dock
- Safety
- Steering, Controls
- Pumps
- Fuel System
- Seating & Pedestals
- Trailering
- Tops & Covers
- Perform.
- Propellers
- Engine & Care
- Cleaning & Care
- Paint & Paint Acc.
- Fun & Flotation
- Topside Acc.
- Cockpit & Deck
- Hardware, Fasteners
- Camouflage
- Misc.
- Comm.



Science.  
Applied to Life.™

3M is  
Contin

Red

AO

Comprehensive line of economical abrasives. Best in class performance. Made with Aluminum Oxide.



3M™ Green Corps™, Gold AO+ CC

Full line of standard and coarse grade abrasives that mix quality minerals and precision coating to deliver quality performance and improved life. Made with Premium Aluminum Oxide and Crushed Ceramic. 3M first used ceramic grains in 1988 for automotive abrasives.

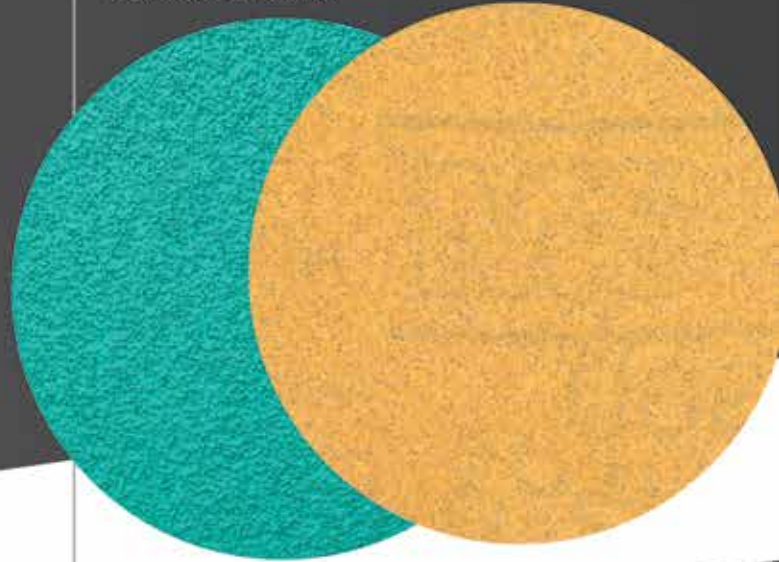

Faster Cut. Better

Aluminum Oxide AO

General purpose grain. Hardness and toughness properties align with paint stripping and finishing grades. Will not

Premium Aluminum Oxide AO+

Filtered for more uniform shape and better toughness. Leads to faster mass removal and longer life than standard

# Leading Advancement in Marine Abrasives.

Continuous abrasive grain innovation to meet every customer need.

## Purple Clean Sand

CC AO+

3M's full purple line uses ceramic grains for next level performance. Sand faster and deliver a more consistent finish.

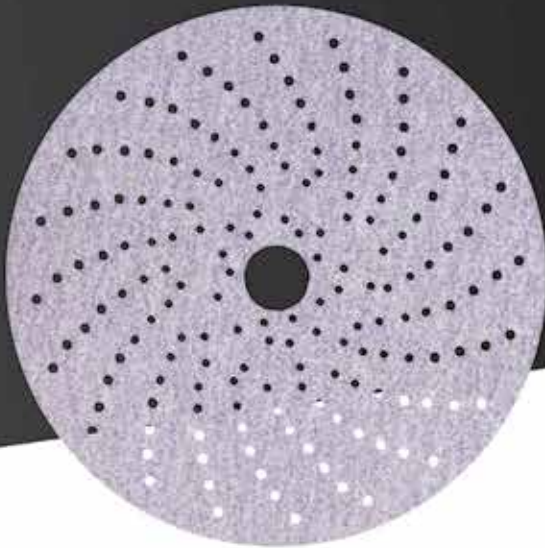

## CUBITRON II

PSG

Revolutionary 3M™ Precision Shaped Grain fractures evenly to continually slice through material, wear evenly, and provide extra-long life and superior consistency.

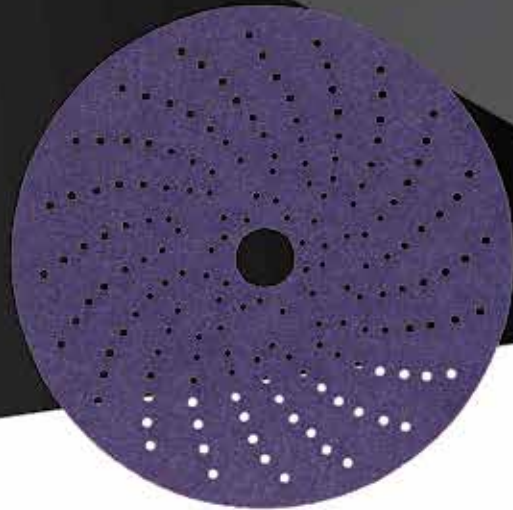

# Finish. Longer Life.

3M has been using ceramics in automotive abrasives for over 25 years.

## Crushed Ceramic

CC

Synthetic material is tougher than Aluminum Oxide. Ceramic grains remove material faster and more uniformly than naturally c

3M is the only one offering abrasives with patented 3M™ Precision Shaped Grain.

## 3M™ Precision Shaped Grain

PSG

Shaped ceramics match the toughness of synthetic products and add superior triangular shape. Triangular peaks slice through material and assist removal and longest life.



**3M Hookit™ Clean Sanding Discs (236U) - 5" Diameter**

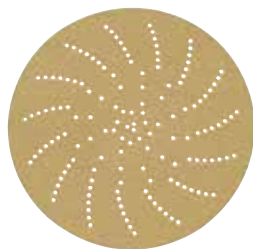

- Precise multi-hole pattern means excellent dust extraction and eliminates the need to align holes.
- Open coat and load-resistant coating prevents clogging to optimize cut and product life.
- Easy to change and reuse, maximizing utility for the life of the disc.
- Aluminum oxide grains cut faster and last longer than traditional garnet.
- Strong, C-weight paper backing supports aggressive sanding.

Order No.	Mfg. No. / Description	List Price
<b>887031</b>	(55598) P80 Grade 50 Discs Per Roll	<b>\$46.19</b> FO-3323000
<b>887036</b>	(55501) P220 Grade 50 Discs Per Roll	<b>\$49.49</b> FO-4643000
<b>887038</b>	(55503) P320 Grade 50 Discs Per Roll	<b>\$49.49</b> FO-4643000
<b>887039</b>	(55504) P400 Grade 50 Discs Per Roll	<b>\$46.19</b> FO-3323000

**3M Cubitron™ II Hookit™ Clean Sanding Discs - 6" Diameter**



- Features 3M Precision-Shaped Grain, triangular-shaped grains that cut 30% faster than other premium abrasives.
- Grains expose fresh abrasive as they wear for 2x longer abrasive life vs. traditional abrasives.
- Sharper cutting surface means less pressure is required for reduced friction and wear.
- Clean Sanding multi-hole pattern delivers excellent dust extraction.
- 3M Hookit hook-and-loop attachment makes for fast disc change-outs.
- Long lasting, fast-cutting abrasive disc is ideal for a range of jobs including paint removal and feather-edging.

Order No.	Mfg. No. / Description	List Price
<b>886052</b>	(31370) 40+ Grade 25 Discs Per Box	<b>\$78.49</b> FO-4945000
<b>886054</b>	(31372) 120+ Grade 50 Discs Per Box	<b>\$65.09</b> FO-6554000

**3M Hookit™ Flexible Abrasive Discs - 6" Diameter**



- Offers high flexibility and conformability.
- Premium quality delivers uniform, consistent finishes every time.
- Reduced burn through when sanding thin coated surfaces.
- Wide range of grades for precision-perfect results.
- 3M Hookit attachment system provides easy reuse, optimizing disc life.
- Long-lasting abrasives reduce material consumption.

Order No.	Mfg. No. / Description	List Price
<b>852676</b>	(34405) P600 Grade 25 Discs Per Box	<b>\$60.49</b> FO-4324000
<b>852678</b>	(34406) P800 Grade 25 Discs Per Box	<b>\$60.49</b> FO-4324000
<b>852680</b>	(34407) P1000 Grade 25 Discs Per Box	<b>\$60.49</b> FO-4324000
<b>852682</b>	(34409) P1500 Grade 25 Discs Per Box	<b>\$60.49</b> FO-4324000

**3M Stikit™ Paper Disc Rolls (236U) - 5" Diameter**



- Adhesive backing allows for quick application and easy removal.
- Convenient disc rolls eliminate the need to remove disc liners from individual discs.
- Strong, C-weight paper backing provides extra durability when compared to lighter weight paper backings.
- Aluminum oxide mineral is durable, cuts fast, and performs well on many surfaces.
- Load-resistant coating helps prevent premature loading of the disc surface to maximize cut and extend the life of the abrasive grains.

Order No.	Mfg. No. / Description	List Price
<b>886361</b>	(55540) P80 Grade 100 Discs Per Roll	<b>\$57.69</b> FO-8304000
<b>886385</b>	(55542) P120 Grade 100 Discs Per Roll	<b>\$52.29</b> FO-0663000
<b>886388</b>	(55545) P220 Grade 100 Discs Per Roll	<b>\$54.69</b> FO-8283000
<b>886397</b>	(55547) P320 Grade 100 Discs Per Roll	<b>\$52.29</b> FO-0663000

**3M Hookit™ Purple Clean Sanding Discs - 6" Diameter**

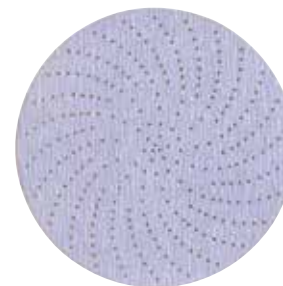

- Disc with precise hole design for improved life and dust extraction.
- Use for fine featheredging or the last sanding step before priming.
- 3M's fastest cutting, longest lasting abrasive for saving labor costs and improving quality.

Order No.	Mfg. No. / Description	List Price
<b>887060</b>	(31371) P80 Grade 50 Discs Per Box	<b>\$77.89</b> FO-2545000
<b>887064</b>	(31374) P180 Grade 50 Discs Per Box	<b>\$65.09</b> FO-6554000
<b>887066</b>	(31481) P220 Grade 50 Discs Per Box	<b>\$65.09</b> FO-6554000
<b>887068</b>	(31483) P320 Grade 50 Discs Per Box	<b>\$65.49</b> FO-4854000
<b>887070</b>	(31484) P400 Grade 50 Discs Per Box	<b>\$67.29</b> FO-0174000

**3M Hookit™ Purple Finishing Film Discs - 6" Diameter**



- Long-lasting abrasive disc produces easy-to-polish finish.
- Specially formulated coating reduces pigtailed and boosts abrasive life.
- Flexible, durable film backing increases conformability.
- Several hole designs available for better dust extraction.
- Hookit attachment system makes for fast, efficient disc change-outs.

Order No.	Mfg. No. / Description	List Price
<b>852674</b>	(30669) P1000 Grade 50 Discs Per Box	<b>\$89.29</b> FO-0526000
<b>852672</b>	(30668) P1200 Grade 50 Discs Per Box	<b>\$89.29</b> FO-0526000
<b>852670</b>	(30667) P1500 Grade 50 Discs Per Box	<b>\$89.29</b> FO-0526000

3M Purple Abrasive Disc - 6" Diameter

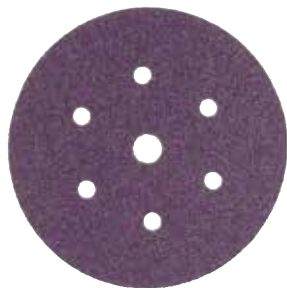

- Premium aluminum oxide abrasive offers a fast cut, long life and professional results.
- Heavy E-weight paper backing adds durability.
- Range of coarse grits is ideal for aggressive jobs such as removing paint.
- Available in Hookit and Stikit attachment.

Order No.	Mfg. No. / Description	List Price
2012276	(30787) 36E Grade 25 Discs Per Box	\$90.99 F0-9636000

3M Green Corps™ Stikit™ Production™ Discs - 6" Diameter



- Abrasive discs for shaping plastic filler, removing paint and shaping metal.
- Ceramic aluminum oxide mineral blend delivers a fast cut rate.
- Heavy weight E backing adds durability.
- Pressure sensitive adhesive for quick and easy disc changes.
- Versatile discs for a variety of automotive surface materials.

Order No.	Mfg. No. / Description	List Price
852992	(01548) 36E Grade	\$254.89 F0-2487100
852980	(01547) 40E Grade	\$227.49 F0-4295100

3M Clean Sanding Discs - 6" Diameter

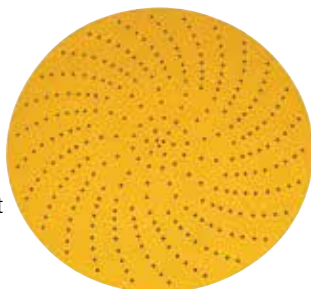

- An aluminum oxide Hookit disc with precise hole design for improved dust extraction constructed on a C Weight.
- Excellent for dry sanding applications like gel coat, composites, wood, paint prep and primer sanding.
- Design doesn't require alignment of holes with the disc pad.
- Simpler to use than a standard "dust free" system.
- Fits all dustless sanding systems.
- 50 Discs Per Roll.

Order No.	Mfg. No. / Description	List Price
887045	(55506) P80 Grade	\$62.59 F0-1834000
887047	(55508) P120 Grade	\$55.79 F0-5093000
887049	(55510) P180 Grade	\$55.79 F0-5093000
887050	(55511) P220 Grade	\$55.79 F0-5093000
887052	(55513) P320 Grade	\$55.79 F0-5093000

3M Trizact™ Hookit™ Foam Disc - 6" Diameter



- Ideal for refining sand scratches to help reduce the amount of time spent compounding.
- Patterned, precise mineral structures provide a combination of fast cut and consistent finish.
- Long lasting, even-wearing abrasive can reduce or eliminate extra materials and even full stages in specific cases.
- Hookit attachment system allows for fast, easy change outs with Hookit disc pads and soft interface pads.

Order No.	Mfg. No. / Description	List Price
852660	(02085) P3000 Grade 15 Discs Per Box	\$136.09 F0-6259000

3M Stikit™ Finishing Film Discs - 6" Diameter



- Film-backed abrasive discs for standard high-finish auto body sanding applications.
- Durable film backing is tear-resistant and provides a consistent finish.
- Aluminum oxide abrasive delivers a fast cut and long life.
- Resin bonding resists heat for added durability.
- Stikit attachment system makes for quick and easy disc change-outs.

Order No.	Mfg. No. / Description	List Price
852637	(01321) P600 Grade 100 Discs Per Box	\$149.29 F0-0540100
852636	(01320) P800 Grade 100 Discs Per Box	\$149.29 F0-0540100
852635	(01319) P1000 Grade 100 Discs Per Box	\$149.29 F0-0540100
852634	(01318) P1200 Grade 100 Discs Per Box	\$144.99 F0-9410100

3M Stikit™ Paper Disc Rolls (3631) - 6" Diameter



- Aluminum oxide on heavy F Weight paper backing provides the durability needed for both stock removal and finishing.
- Open coating prevents clogging to maximize cut and extend the life of the abrasive.
- Resin bond resists heat to prolong the life of the disc.
- Convenient disc rolls eliminate the need to remove disc liners from individual discs.
- 100 Discs Per Roll.

Order No.	Mfg. No. / Description	List Price
852930	(21794) 60F Grade	\$126.69 F0-8688000
852928	(21793) 80F Grade	\$113.99 F0-9797000
852924	(21791) P120F Grade	\$108.19 F0-3757000

- Electronics
- Trolling Motors
- Instruments
- Electrical
- Lighting
- Anchor & Dock
- Safety
- Steering, Controls
- Pumps
- Fuel System
- Seating & Pedestals
- Trailer
- Tops & Covers
- Perform.
- Propellers
- Engine & Care
- Cleaning & Care
- Paint & Paint Acc.
- Fun & Flotation
- Topside Acc.
- Cockpit & Deck
- Hardware, Fasteners
- Camouflage
- Misc.
- Comm.

3M Stikit™ Paper Disc Rolls (236U) - 6" Diameter



- Adhesive backing allows for quick application and easy removal.
- Convenient disc rolls eliminate the need to remove disc liners from individual discs.
- Aluminum oxide mineral is durable, cuts fast and performs well on many surfaces.
- Strong, C Weight paper backing provides extra durability when compared to lighter weight paper backings.
- Load-resistant coating helps prevent premature loading of the disc surface to maximize cut and extend the life of the abrasive grains.
- 100 Discs Per Roll.

Order No.	Mfg. No. / Description	List Price	
852841	(55560) P80 Grade	\$81.49	F0-4075000
852839	(55561) P100 Grade	\$75.19	F0-3625000
852827	(55562) P120 Grade	\$75.19	F0-3625000
852815	(051131-55563) P150 Grade	\$68.99	F0-9284000
852803	(55564) P180 Grade	\$75.19	F0-3625000
852790	(55565) P220 Grade	\$75.19	F0-3625000
852764	(55567) P320 Grade	\$75.19	F0-3625000
852776	(55568) P400 Grade	\$75.19	F0-3625000
852788	(55569) P500 Grade	\$68.99	F0-9284000

3M Hookit™ Disc Pads - 6" Diameter



HOOKIT SOFT INTERFACE PAD

- Designed for 3M Hookit abrasives. For use with all 3M Hookit disc pads.
- Improves abrasive cut and finish. Reduces vibration on dual action random orbital sanders using 3M Hookit disc pads.

Order No.	Mfg. No. / Description	List Price	
853182	(05777)	\$20.99	F0-9641000

HOOKIT CLEAN SANDING LOW PROFILE DISC PADS

- For use with Hookit Clean Sanding Discs or Hookit Dust Free Discs.

Order No.	Mfg. No. / Description	List Price	
853174	(20356) Firm Red Foam	\$41.29	F0-0982000
853176	(20425) Soft Beige Foam	\$41.29	F0-0982000

3M Stikit™ Disc Pads - 6" Diameter

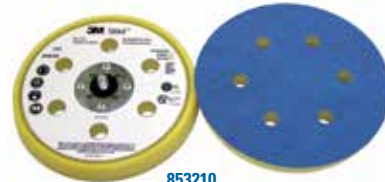

STIKIT DUST FREE LOW PROFILE FINISHING DISC PAD

- Has a soft foam face (brown) construction for conformability and improved surface finish on sanded parts.

Order No.	Mfg. No. / Description	List Price	
853210	(05646)	\$38.79	F0-5172000

STIKIT DUST FREE DISC PAD

- These lightweight, shock-resistant pads with vinyl face (blue) provide disc adhesion yet allow quick, easy removal.

Order No.	Mfg. No. / Description	List Price	
853209	(45218)	\$31.39	F0-7912000

3M Stikit™ Paper Disc Rolls - 8" Diameter



- Aluminum oxide on heavy F Weight paper backing provides the durability needed for both stock removal and finishing.
- Open coating prevents clogging to maximize cut and extend the life of the abrasive.
- Resin bond resists heat to prolong the life of the disc.
- Convenient disc rolls eliminate the need to remove disc liners from individual discs.

Order No.	Mfg. No. / Description	List Price	
852916	(21788) 60F Grade	\$115.99	F0-9118000
852905	(21787) 80F Grade	\$103.09	F0-6127000
852891	(21785) P120F Grade	\$95.59	F0-1966000

3M Green Corps™ Stikit™ Production Discs - 8" Diameter



- Made with a blend of abrasives including 3M's high performance ceramic abrasive grain which provides increased abrasive life and a faster cut rate when used on plastic filler.
- Extremely durable for sanding paint, metal or fiberglass.
- Open coat construction reduces loading on fresh filler.
- Use for stripping paint to metal, shaping and sanding plastic filler.

Order No.	Mfg. No. / Description	List Price	
853057	(01552) 24E Grade	\$90.59	F0-1436000
853019	(01551) 36E Grade	\$232.29	F0-0626100
853007	(01550) 40E Grade	\$208.69	F0-8064100
853071	(01556) 60E Grade	\$158.59	F0-1011100
853021	(01549) 80D Grade	\$166.99	F0-9861100



3M Hookit™ Disc Pad - 8" Diameter



- Use with slow speed polisher/grinder.
- Ideal for use with fine grade abrasives for sanding primer on conformable surfaces.

Order No.	Mfg. No. / Description	List Price
<b>854097</b>	(05768) Soft	<b>\$102.79</b> F0-5917000

3M PSA Cloth Disc - 777F



- 3M ceramic aluminum oxide blend abrasive grain on a polyester cloth backing.
- Heavy duty YF Weight backing provides great strength and flexibility.
- Provides a long life and fast cut on multiple surfaces.
- Includes a grinding aid for cooler running.
- Diameter 12".
- 10 discs per box.

Order No.	Mfg. No. / Description	List Price
<b>854998</b>	(88873) 40 Grade	<b>\$167.89</b> F0-2571100

3M Filter Bag for Orbital Sanders



- Used on Random Orbital Sanders with Self-Generated Vacuum to collect sanding dust.
- Eliminates the need for vacuum hose which improves operator ease of use.
- Use with 3M Filter Bag Adapter to attach bag to sander.
- HEPA rated.

Order No.	Mfg. No. / Description	List Price
<b>886929</b>	(20452) Large	<b>\$5.39</b> F0-7730000

3M Stikit™ Disc Pads - 8" Diameter



- Use with slow speed polisher/grinder.
- Ideal for use with abrasives for paint stripping and sanding primer on conformable surfaces.

Order No.	Mfg. No. / Description	List Price
<b>853211</b>	(05579) Medium	<b>\$89.99</b> F0-9926000
<b>853215</b>	(05568) Soft	<b>\$94.49</b> F0-4166000

3M Random Orbital Sander with Self-Generated Vacuum



- Pneumatic. Orbit diameter: 3/16".
- Designed to work with 3M's proprietary self-contained dust collection system to trap and contain airborne particles during the finishing process.
- Consistent sand scratch for a better finish.
- Very smooth, fingertip control.
- They can also be used with conventional filter bags.
- Includes: (1) Clean Sanding Pad, (1) 3M Clean Sanding Filter Bag (1) Filter Bag Adapter and (1) Hose Seal.

Order No.	Mfg. No. / Description	List Price
<b>886905</b>	(20327) 6"	<b>\$300.89</b> F0-2601200

3M Green Corps™ Fibre Discs



- Used for grinding door skins, MIG welds or any kind of metal or fiberglass grinding.
- Other applications include paint, rust and weld removal and metal work.
- Sold 20 discs per box.

Order No.	Mfg. No. / Description	List Price
<b>854778</b>	(01915) 5" x 7/8" 24 Grade	<b>\$129.39</b> F0-7509000
<b>854776</b>	(01914) 5" x 7/8" 36 Grade	<b>\$126.59</b> F0-1688000

- Electronics
- Trolling Motors
- Instruments
- Electrical
- Lighting
- Anchor & Dock
- Safety
- Steering, Controls
- Pumps
- Fuel System
- Seating & Pedestals
- Trailering
- Tops & Covers
- Perform.
- Propellers
- Engine & Care
- Cleaning & Care
- Paint & Paint Acc.
- Fun & Flotation
- Topside Acc.
- Cockpit & Deck
- Hardware, Fasteners
- Camouflage
- Misc.
- Comm.

3M Pistol Grip Disc Sander



- A lightweight sander for spot duty sanding and finishing applications.
- Excellent balance and generates less noise and vibration than other disc sanders.
- Dual mount feature allows user to switch between direct mount, which provides maximum control, and collet mount, which extends the reach of the tool.
- Use with Roloc Disc Assemblies: 2" **853111** (5539) or 3" **853110** (5540).

Order No.	Mfg. No. / Description	List Price
<b>886910</b>	(33577) Tool Diameter: 3"	<b>\$216.79</b> F0-5715100

3M Green Corps™ Roloc™ Discs



- Generally used for hard-to-reach areas in paint, rust and weld removal, these discs have the versatility of the Roloc attachment system with the premium quality of 3M Green Corps brand.
- Green in color with a durable cloth backing.
- Fits any standard 1/4" drill or air tool.
- Sold 25 discs per box.

Order No.	Mfg. No. / Description	List Price
<b>853085</b>	(01397) Diameter 2" 36 Grade	<b>\$53.99</b> F0-9773000
<b>853108</b>	(01408) Diameter 3" 24 Grade	<b>\$67.39</b> F0-7174000
<b>853095</b>	(01407) Diameter 3" 36 Grade	<b>\$62.29</b> F0-0634000
<b>853083</b>	(01406) Diameter 3" 50 Grade	<b>\$59.89</b> F0-2914000

3M Scotch-Brite™ Roloc™ Surface Conditioning Discs



- Use for cleaning and finishing on all metals for removal of light rust, oxides and coatings.
- They combined with the quick "1/2 turn on, 1/2 turn off" Roloc disc fastening system.
- The coarse grade (brown) equates with a coated abrasive grit of 80 to 100 and medium (maroon) 100 to 120 grit.
- Sold 25 discs per box.

Order No.	Mfg. No. / Description	List Price
<b>855105</b>	(07480) Diameter 2" Coarse	<b>\$43.19</b> F0-3203000
<b>855106</b>	(07481) Diameter 2" Medium	<b>\$43.19</b> F0-3203000
<b>853080</b>	(07485) Diameter 3" Coarse	<b>\$81.59</b> F0-1175000
<b>853081</b>	(07486) Diameter 3" Medium	<b>\$81.59</b> F0-1175000

3M Roloc™ Disc Pad Assemblies



- Hard rubber backup provides firm support for 3M Roloc Abrasive Discs.
- Pad has a 1/4-20 INT thread which allows it to be mounted directly to tools with 1/4-20 EXT threaded shafts.
- Includes: Disc pad, shaft and adaptor.
- Sold 10 per case.

Order No.	Mfg. No. / Description	List Price
<b>853111</b>	(05539) Diameter 2"	<b>\$29.59</b> F0-1702000
<b>853110</b>	(05540) Diameter 3"	<b>\$40.29</b> F0-0282000

3M Cubitron™ II Fibre Roloc™ Discs



- 3M Precision-Shaped Grain (PSG) maintains super-sharp points that cut exceptionally fast with less pressure.
- Disc life is significantly longer, completing more vehicle parts per disc and requiring fewer disc changes.
- Triangular-shaped ceramic grain wears evenly, runs cool, and optimizes mineral breakdown.
- Sold 15 discs per box.

Order No.	Mfg. No. / Description	List Price
<b>853120</b>	(33377) Diameter 2" 36+ Grade	<b>\$34.39</b> F0-7042000
<b>853123</b>	(33379) Diameter 2" 60+ Grade	<b>\$33.29</b> F0-0332000
<b>853125</b>	(33380) Diameter 2" 80+ Grade	<b>\$33.29</b> F0-0332000
<b>853130</b>	(33389) Diameter 3" 36+ Grade	<b>\$41.19</b> F0-3882000
<b>853133</b>	(33391) Diameter 3" 60+ Grade	<b>\$39.99</b> F0-9972000

3M Wetordry™ Sheets



- Use in wet sanding, levels orange peel, dust nibs or paint runs.
- Appropriate for light sanding on refinish lacquer.
- Flexible backing and consistent scratch pattern make this 3M best wet sanding product.

**DIMENSIONS: 5-1/2" x 9"**

Order No.	Mfg. No. / Description	List Price
854186	(02021) 1000 Grade 50 Sheets Per Sleeve	\$55.09 F0-6583000
854198	(02022) 1200 Grade 50 Sheets Per Sleeve	\$56.59 F0-1693000
854201	(02023) 1500 Grade 50 Sheets Per Sleeve	\$55.09 F0-6583000
854200	(02044) 2000 Grade 50 Sheets Per Sleeve	\$55.09 F0-6583000

**DIMENSIONS: 9" x 11"**

Order No.	Mfg. No. / Description	List Price
854204	(02034) 1000 Grade 50 Sheets Per Sleeve	\$113.19 F0-3297000

3M Production™ Sheets



- An aluminum oxide sheet constructed on a D Weight, intermediate paper backing.
- Dimensions: 9" x 11'.

Order No.	Mfg. No. / Description	List Price
854390	(02115) 80D Grade 50 Sheets Per Sleeve	\$48.49 F0-4933000

3M Stikit™ Hand Block



- Made of a sturdy, durable, high strength material.
- These blocks have an embossed rubber face which allows good adhesion for Stikit Sheet-Rolls and Stikit Sheets.
- Dimensions: 2-3/4" x 7-3/4".

Order No.	Mfg. No. / Description	List Price
854756	(05441)	\$32.99 F0-9032000

3M Stikit™ Soft Hand Block



- Soft molded foam block with easy release vinyl face.
- Use with Stikit Sheet-Rolls 2-3/4" wide or abrasives sheets 2-3/4" x 5" for leveling of repair area or following contours.
- Dimensions: 2-3/4" x 5".

Order No.	Mfg. No. / Description	List Price
854744	(05442)	\$28.39 F0-7891000

3M Rubber Sanding Block



- A pliable rubber block which holds the sandpaper securely during wet or dry sanding operations.
- Uses a 2-3/4" x 9" sheet.
- Dimensions: 2-3/4" x 5".

Order No.	Mfg. No. / Description	List Price
854732	(05519)	\$17.59 F0-1321000

3M Wetordry™ Tri-M-ite™ Sheets



**A WEIGHT**

- Use in wet sanding, prepping and blending surrounding area.
- Dimensions: 9" x 11".

Order No.	Mfg. No. / Description	List Price
854225	(02000) 600A Grade 50 Sheets Per Sleeve	\$66.39 F0-7464000
854237	(02002) 400A Grade 50 Sheets Per Sleeve	\$66.39 F0-7464000
854251	(02004) 320A Grade 50 Sheets Per Sleeve	\$66.39 F0-7464000
854275	(02007) 220A Grade 50 Sheets Per Sleeve	\$66.39 F0-7464000

**C WEIGHT**

- A silicon carbide Wetordry abrasive product constructed on a C weight, intermediate paper backing.
- Dimensions: 9" x 11".

Order No.	Mfg. No. / Description	List Price
854124	(02014) 180C Grade 50 Sheets Per Sleeve	\$73.19 F0-3215000
854148	(02016) 120C Grade 50 Sheets Per Sleeve	\$80.89 F0-2665000
854150	(02017) 100C Grade 50 Sheets Per Sleeve	\$93.39 F0-7356000
854162	(02018) 80C Grade 50 Sheets Per Sleeve	\$106.79 F0-5747000
854174	(24001) 60C Grade 50 Sheets Per Sleeve	\$127.49 F0-4298000

3M Stikit™ Gold Sheet Rolls



- Use for shaping plastic filler, removing paint around damaged area and scratch refinement of bare metal.
- Eliminates unused portion of torn sheets because nothing is wasted.
- 100% of the abrasive surface is used.
- 2-3/4" width.

Order No.	Mfg. No. / Description	List Price
852560	(02590) P400 Grade 45 Yards	\$70.99 F0-9694000
852561	(02591) P320 Grade 45 Yards	\$70.99 F0-9694000
852563	(02594) P220 Grade 45 Yards	\$70.99 F0-9694000
852564	(02595) P180 Grade 45 Yards	\$72.89 F0-2015000
852565	(02596) P150 Grade 45 Yards	\$70.99 F0-9694000
852566	(02597) P120 Grade 30 Yards	\$70.99 F0-9694000
852568	(02599) P80 Grade 25 Yards	\$70.99 F0-9694000

- Electronics
- Trolling Motors
- Instruments
- Electrical
- Lighting
- Anchor & Dock
- Safety
- Steering, Controls
- Pumps
- Fuel System
- Seating & Pedestals
- Trailering
- Tops & Covers
- Perform.
- Propellers
- Engine & Care
- Cleaning & Care
- Paint & Paint Acc.
- Fun & Flotation
- Topside Acc.
- Cockpit & Deck
- Hardware, Fasteners
- Camouflage
- Misc.
- Comm.



3M Scotch-Brite™ Hand Pads



- Dimensions: 6" x 9".
- Sold 20 pads per box.

LIGHT DUTY CLEANSING PAD

- Pad has fine mineral for very light cleaning.
- Use with liquid detergents for wax mold deflashing, highlighting and top coat rubbing of wood, cleaning of porcelain, stainless steel, chrome, painted surfaces and glass.

Order No.	Mfg. No. / Description	List Price
855087	(07445)	\$32.49 F0-4722000

GENERAL PURPOSE HAND PAD

- For scuffing before applying paint and primer-surfacer.
- Also used for used car reconditioning, cleaning upholstery, headlins and door pads, chrome and white wall tires.
- Rinses clean and does not rust.
- Can be used over and over again.

Order No.	Mfg. No. / Description	List Price
855099	(07447)	\$30.19 F0-3112000

ULTRA FINE HAND PAD

- Use ultra fine hand pad for light cleaning, finishing of metal, plastic, composite and wood surfaces.
- For final sanding of primer-surfacer.
- Rinses clean, will not rust and can be used over and over again.

Order No.	Mfg. No. / Description	List Price
855102	(07448)	\$31.69 F0-8122000

3M Scotch-Brite™ General Purpose Scouring Pad



- Use for everyday cleaning of most cooking utensils and equipment.
- Scours 2 to 3 times faster and lasts 2 to 3 times longer than comparable pads.
- Non-rusting and resilient, this synthetic pad is an ideal replacement for steel wool or stainless steel scrubbers.
- Dimensions: 6" x 9".
- Sold per pad.

Order No.	Mfg. No. / Description	List Price
855080	(08293)	\$0.99 F0-9600000

3M Three-M-ite® Elek-Tro-Cut® Cloth Utility Rolls



- The aluminum oxide abrasive is glue bonded to a J Weight cloth backing.
- Use for general purpose sanding; cleaning metals prior to welding; blending and repairing metal finishes; fine sanding and polishing applications; removing rust, scale and contaminants; deburring operations by hand or by machine; surface preparation for paints and coatings.

Order No.	Mfg. No. / Description	List Price
855001	(05002) 320 Grade 1" W x 50 yds.	\$71.99 F0-9305000
855037	(05006) 180 Grade 1" W x 50 yds.	\$68.99 F0-9284000
855051	(05010) 80 Grade 1" W x 50 yds.	\$72.59 F0-1805000

3M Cloth Belt - 777F



- Cubitron abrasive grain cloth belt constructed on water resistant polyester cloth backing.
- Resin bonded for heat resistance.
- Features grinding aid for cooler grinding.
- Easiest to break down among premium abrasives.
- Use with softer contact wheel. Better for shorter welds and seams.
- 20 belts per box.

Order No.	Mfg. No. / Description	List Price
854999	(77927) 40 Grade	\$627.99 F0-9593400

- Electronics
- Trolling Motors
- Instruments
- Electrical
- Lighting
- Anchor & Dock
- Safety
- Steering, Controls
- Pumps
- Fuel System
- Seating & Pedestals
- Trailering
- Tops & Covers
- Perform.
- Propellers
- Engine & Care
- Cleaning & Care
- Paint & Paint Acc.
- Fun & Flotation
- Topside Acc.
- Cockpit & Deck
- Hardware, Fasteners
- Camouflage
- Misc.
- Comm.

3M 6000 Series Full Facepiece Respirators - Reusable



- Offers versatility for many environments and applications and helps provide respiratory protection against a wide variety of gases and vapors when used approved cartridges and filters.
- Unique center adapter to direct exhaled breath and moisture downward, helps reduce debris from depositing in the valve and allows for quick and easy cleaning.
- Large lens for wide field of view and excellent visibility.
- 3M Cool Flow Valve for cooler, drier comfort.
- Lightweight, well-balanced design with silicone faceseal for enhanced comfort and durability.
- Air purifying respirator (APR), supplied air (SA) and powered air purifying respirator (PAPR) modes.
- NIOSH Approved.

Order No.	Mfg. No. / Description	List Price	
857053	(54146) Medium (6800)	\$198.29	F0-0883100
857054	(54159) Large (6900)	\$198.29	F0-0883100
856655	(07142) Face Shield Cover (6885)	\$64.29	F0-0054000
857035	(37004) Nose Cup Assembly (6894)	\$44.29	F0-0013000

3M 6000 Series Half Facepiece Respirators - Reusable



- The 6000 Series Respirator is a NIOSH/MSHA approved half-mask respirator that is adaptable to a wide range of respiratory protection.
- Its low maintenance, comfortable design allows greater worker flexibility by the use of five different type cartridges and two types of prefilters for a variety of work environments.
- Cartridges are simply twisted on or off of the facepiece for easy replacement which allows the facepiece to be used over and over.
- Supplied with a storage bag.

Order No.	Mfg. No. / Description	List Price	
857044	(07025) Medium (6200)	\$18.19	F0-3721000
857046	(07026) Large (6300)	\$18.19	F0-3721000
854287	(54356) Particulate Filter (2071), 2 Per Pack	\$6.29	F0-0440000
854299	(07000) Particulate Filter (2091), 2 Per Pack	\$9.79	F0-5860000
854984	(46464) Particulate Filter (5N11), 10 Per Pack	\$20.59	F0-1441000
854996	(17668) Filter Retainer, Sold 20 Per Pack	\$55.89	F0-2193000
857041	(21674) Organic Vapor Cartridge (6001)	\$16.09	F0-6211000
857039	(07047) Organic Vapor/Acid Gas Cart. (6003)	\$17.99	F0-9521000

3M 7500 Series Half Facepiece Respirator - Reusable

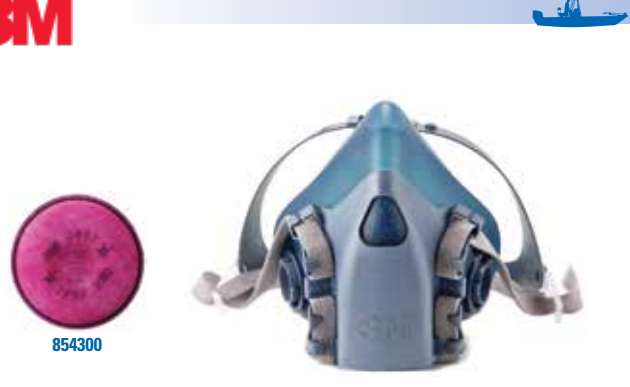

- Advanced silicone material for increased comfort and greater durability.
- 3M Cool Flow Valve for cooler, drier comfort.
- Dual-mode head harness that adjusts so users can wear the respirator in either standard or drop-down mode.
- Solid exhalation valve cover which directs exhaled breath and moisture downward while helping protect the valve area from debris while also making for easier cleaning.

Order No.	Mfg. No. / Description	List Price	
857051	(7503) Large	\$39.89	F0-2972000

PARTICULATE FILTER WITH NUISANCE LEVEL ORGANIC VAPOR RELIEF

Order No.	Mfg. No. / Description	List Price	
854300	(07184) Sold 2 Per Pack	\$13.39	F0-7390000

3M Half Facepiece Disposable Respirator Assemblies - Dual Cartridge



- NIOSH approved for respiratory protection against certain organic vapors and particulates.
- Lightweight, well-balanced design enhances comfort.
- Disposable model helps reduce maintenance issues for greater convenience.
- Multi-purpose respirator assembly works in a variety of workplace applications.
- Half facepiece design is ideal for intermittent use.

Order No.	Mfg. No. / Description	List Price	
856611	(66069) Medium (52P71)	\$30.79	F0-5512000
856623	(66070) Large (53P71)	\$29.99	F0-9902000
856625	(07194) Particulate Filter, Sold 10 Per Box	\$25.59	F0-1971000

DUAL CARTRIDGE RESPIRATOR PACKOUT

- Includes the 3M Low Maintenance Half Facepiece, (1) pair Organic Vapor Cartridges - 07046, (1) pair Filter Retainers - 07054 and (2) pairs of P-95 Filters - 07194.

Order No.	Mfg. No. / Description	List Price	
857048	(07178) Medium	\$48.29	F0-0833000
857049	(07179) Large	\$49.69	F0-8743000

- Electronics
- Trolling Motors
- Instruments
- Electrical
- Lighting
- Anchor & Dock
- Safety
- Steering, Controls
- Pumps
- Fuel System
- Seating & Pedestals
- Trailer
- Tops & Covers
- Perform.
- Propellers
- Engine & Care
- Cleaning & Care
- Paint & Paint Acc.
- Fun & Flotation
- Topside Acc.
- Cockpit & Deck
- Hardware, Fasteners
- Camouflage
- Misc.
- Comm.

3M 8247, R95 Particulate Respirator



- Disposable.
- This respirator helps provide comfortable protection against certain oil and non-oil based particles – including those with nuisance levels of organic vapors, such as solvents, degreasers and resins.
- Collapse resistant shell.
- Carbon filter provides relief against nuisance levels of organic vapors.
- Compatible with a variety of protective eyewear and hearing protection.
- Adjustable noseclip reduces potential for eyewear fogging and helps ensure a better seal and fit.
- Two-strap design with dual point attachment helps provide a secure fit.
- NIOSH Approved R95.

Order No.	Mfg. No. / Description	List Price

3M 8212, N95 Particulate Welding Respirator with Foam Face Seal



- Disposable.
- Designed to help provide respiratory protection for applications such as welding or soldering where metal fumes may be present.
- Cake resistant filter media.
- Flame resistant per ASTM D2859.
- Comfortable foam face seal.
- Fully adjustable headstraps help provide a secure fit.
- 3M Cool Flow Exhalation Valve.
- Adjustable noseclip reduces potential for eyewear fogging and helps ensure a better seal and fit.
- NIOSH Approved.

Order No.	Mfg. No. / Description	List Price
856560	(54141) Sold 10 Per Bag	\$87.59 F0-1316000

3M 8511, N95 Particulate Respirator



- Disposable.
- Provide protection against certain non-oil based particles.
- 3M Cool Flow Exhalation Valve.
- Braided headbands two-strap design with dual point attachment helps provide a secure fit.
- Adjustable M-noseclip reduces potential for eyewear fogging and helps ensure a secure seal and fit.
- NIOSH Approved.

Order No.	Mfg. No. / Description	List Price
856550	(54343) Sold 10 Per Bag	\$29.39 F0-7502000

3M 8210, N95 Particulate Respirator



- Disposable.
- Two-strap design with welded dual point attachment helps provide a secure seal.
- Cushioning nose foam.
- Advanced electrostatic media.
- Adjustable noseclip to help provide a custom fit and secure seal.
- NIOSH Approved for at least 95 percent filtration efficiency against certain non-oil based particles.

Order No.	Mfg. No. / Description	List Price
856630	(46457) Sold 20 Per Bag	\$24.79 F0-5371000

3M Hard Hats



- Comfortable, 4-point suspension and standard brow pad.
- Features accessory slots for ear muff attachment and/or headgear and faceshield attachment.
- Meets requirements of ANSI/ISEA Z89.1-2009 Type 1, Class C, G and E.
- White.

Order No.	Mfg. No. / Description	List Price
854330	(64187) Pinlock Suspension	\$14.89 H0-3980000
854340	(64197) Ratchet Suspension	\$18.99 H0-9311000

3M Respirator Cleaning Wipes



- Used to clean 3M Elastomeric Facepiece Respirators.
- Individually packed 8" x 10" towelettes are alcohol free and will not damage the facepiece materials.
- Conveniently packaged in a dispenser style box that can be wall mounted for easy access.

Order No.	Mfg. No. / Description	List Price
856659	(07065) Sold 100 Per Box	\$64.79 F0-5354000

# Helping You Wear It Right

## Wearing your 3M Half Facepiece Reusable Respirator

1



Place the respirator over your nose and mouth with bottom straps unfastened.

2



Pull the top strap over your head, placing the head cradle on the crown of your head.

3



Hook the bottom straps together behind your neck.

4



Adjust strap tension to achieve a secure fit.





Freshwater Exclusive



Saltwater Exclusive

Dr. Shrink "Total Shrink Wrap Protection"

1163

Paint & Paint Acc.

# TOTAL SHRINK WRAP PROTECTION

- YACHT REFINISHING
- SCAFFOLDING AND CONTAINMENT
- PROTECTS FROM PAINT OVERSPRAY
- REFIT YEAR-ROUND

## Dr. Shrink+

INTERNATIONAL SHRINK WRAP SUPPLIER

TRAINING & HOW-TO RESOURCES

[dr-shrink.com](http://dr-shrink.com)

MADE IN AMERICA  
QUALITY ASSURED



Electronics

Trolling Motors

Instruments

Electrical

Lighting

Anchor & Dock

Safety

Steering, Controls

Pumps

Fuel System

Seating & Pedestals

Trailering

Tops & Covers

Perform.

Propellers

Engine & Care

Cleaning & Care

Paint & Paint Acc.

Fun & Flotation

Topside Acc.

Cockpit & Deck

Hardware, Fasteners

Camouflage

Misc.

Comm.

# TOTAL SHRINK WRAP PROTECTION

## Dr. Shrink+

INTERNATIONAL SHRINK WRAP SUPPLIER

TRAINING & HOW-TO RESOURCES

[dr-shrink.com](http://dr-shrink.com)

MADE IN AMERICA  
QUALITY ASSURED





Dr. Shrink Shrink Wrap



- Shrink wrap protects against weather damage.
- It's waterproof - it can fully encapsulate just about anything.
- One piece coverage.
- Cover entire flatbed loads and boats 60' + boats with one piece.
- 100% virgin resin shrink wrap with maximum UV inhibitors costs only pennies per square foot.
- Our shrink wrap covers can be ventilated to eliminate moisture and mildew problems.

SHRINK WRAP - 6 MIL

Order No.	Mfg. No.	Size	Color	List Price	FO
2228130	(DS-126175B)	12' W x 175' L	Blue	\$181.09	F0-6762100
2228133	(DS-126175W)	12' W x 175' L	White	\$181.09	F0-6762100
2228142	(DS-146150B)	14' W x 150' L	Blue	\$181.09	F0-6762100
2228145	(DS-146150C)	14' W x 150' L	Clear	\$181.09	F0-6762100
2228147	(DS-146150W)	14' W x 150' L	White	\$181.09	F0-6762100
2228149	(DS-146300B)	14' W x 300' L	Blue	\$362.19	F0-3535200
2228151	(DS-146300W)	14' W x 300' L	White	\$362.19	F0-3535200
2228162	(DS-166200W)	16' W x 200' L	White	\$275.99	F0-9139100
2228167	(DS-176031B)	17' W x 31' L	Blue	\$45.49	F0-4813000
2228169	(DS-176120B)	17' W x 120' L	Blue	\$175.99	F0-9132100
2228172	(DS-176120C)	17' W x 120' L	Clear	\$175.99	F0-9132100
2228174	(DS-176120W)	17' W x 120' L	White	\$175.99	F0-9132100
2228177	(DS-176270B)	17' W x 270' L	Blue	\$395.89	F0-2177200

Order No.	Mfg. No.	Size	Color	List Price	FO
2228179	(DS-176270W)	17' W x 270' L	White	\$395.89	F0-2177200
2228183	(DS-176410B)	17' W x 410' L	Blue	\$598.89	F0-2291400
2228188	(DS-176410W)	17' W x 410' L	White	\$598.89	F0-2291400
2228212	(DS-206100B)	20' W x 100' L	Blue	\$172.49	F0-4702100
2228215	(DS-206100C)	20' W x 100' L	Clear	\$172.49	F0-4702100
2228218	(DS-206100W)	20' W x 100' L	White	\$172.49	F0-4702100
2228220	(DS-206240W)	20' W x 240' L	White	\$413.99	F0-9798200
2228235	(DS-246045B)	24' W x 45' L	Blue	\$93.19	F0-3256000
2228237	(DS-246085B)	24' W x 85' L	Blue	\$175.99	F0-9132100
2228239	(DS-246085W)	24' W x 85' L	White	\$175.99	F0-9132100
2228242	(DS-246115B)	24' W x 115' L	Blue	\$237.99	F0-9566100
2228244	(DS-246115W)	24' W x 115' L	White	\$237.99	F0-9566100

SHRINK WRAP - 7 MIL

Order No.	Mfg. No.	Size	Color	List Price	FO
2228135	(DS-127149B)	12' W x 149' L	Blue	\$178.89	F0-2252100
2228138	(DS-127149W)	12' W x 149' L	White	\$178.89	F0-2252100
2228153	(DS-147128B)	14' W x 128' L	Blue	\$179.19	F0-3452100
2228155	(DS-147128W)	14' W x 128' L	White	\$179.19	F0-3452100
2228157	(DS-147213B)	14' W x 213' L	Blue	\$298.29	F0-0880200
2228159	(DS-147213W)	14' W x 213' L	White	\$298.29	F0-0880200
374065	(DS-147425B)	14' W x 425' L	Blue	\$598.89	F0-2291400
373996	(DS-147425W)	14' W x 425' L	White	\$598.89	F0-2291400
2228165	(DS-167200W)	16' W x 200' L	White	\$320.09	F0-6042200
2228191	(DS-177031W)	17' W x 31' L	White	\$52.79	F0-5963000
2228194	(DS-177110B)	17' W x 110' L	Blue	\$186.99	F0-9803100
2228196	(DS-177110W)	17' W x 110' L	White	\$186.99	F0-9803100
2228199	(DS-177175B)	17' W x 175' L	Blue	\$297.59	F0-1380200
2228202	(DS-177175W)	17' W x 175' L	White	\$297.59	F0-1380200
374067	(DS-177350B)	17' W x 350' L	Blue	\$598.89	F0-2291400
374000	(DS-177350W)	17' W x 350' L	White	\$598.89	F0-2291400
2228204	(DS-187200B)	18' W x 200' L	Blue	\$360.09	F0-6025200
2228207	(DS-187200W)	18' W x 200' L	White	\$360.09	F0-6025200
2057570	(DS-187330B)	18' W x 330' L	Blue	\$583.19	F0-3280400
205756	(DS-187330W)	18' W x 330' L	White	\$598.89	F0-2291400
2228223	(DS-207089B)	20' W x 89' L	Blue	\$178.09	F0-6642100
2228225	(DS-207089W)	20' W x 89' L	White	\$178.09	F0-6642100
2228228	(DS-207200W)	20' W x 200' L	White	\$400.09	F0-6008200
374071	(DS-207298B)	20' W x 298' L	Blue	\$598.89	F0-2291400
374010	(DS-207298W)	20' W x 298' L	White	\$598.89	F0-2291400
205889	(DS-207298C)	20' W x 298' L	Clear	\$598.89	F0-2291400
2228230	(DS-227100W)	22' W x 100' L	White	\$219.99	F0-9935100
2228247	(DS-247050W)	24' W x 50' L	White	\$120.09	F0-6048000

Order No.	Mfg. No.	Size	Color	List Price	FO
2228249	(DS-247120W)	24' W x 120' L	White	\$288.09	F0-6610200
374022	(DS-247248B)	24' W x 248' L	Blue	\$598.89	F0-2291400
374020	(DS-247248W)	24' W x 248' L	White	\$598.89	F0-2291400
2228252	(DS-267100B)	26' W x 100' L	Blue	\$260.09	F0-6028100
2228255	(DS-267100W)	26' W x 100' L	White	\$260.09	F0-6028100
2228257	(DS-267160W)	26' W x 160' L	White	\$415.89	F0-2119200
374179	(DS-267229B)	26' W x 229' L	Blue	\$598.89	F0-2291400
374030	(DS-267229W)	26' W x 229' L	White	\$598.89	F0-2291400
2228260	(DS-287064W)	28' W x 64' L	White	\$179.19	F0-3452100
2228263	(DS-287114W)	28' W x 114' L	White	\$319.19	F0-3432200
374183	(DS-287213B)	28' W x 213' L	Blue	\$598.89	F0-2291400
374040	(DS-287213W)	28' W x 213' L	White	\$598.89	F0-2291400
2228265	(DS-287213C)	28' W x 213' L	Clear	\$598.89	F0-2291400
2228268	(DS-327065B)	32' W x 65' L	Blue	\$208.09	F0-6654100
2228271	(DS-327065W)	32' W x 65' L	White	\$208.09	F0-6654100
2228274	(DS-327100B)	32' W x 100' L	Blue	\$320.09	F0-6042200
2228276	(DS-327100C)	32' W x 100' L	Clear	\$320.09	F0-6042200
2228279	(DS-327100W)	32' W x 100' L	White	\$320.09	F0-6042200
374050	(DS-327186W)	32' W x 186' L	White	\$598.89	F0-2291400
2228283	(DS-367070W)	36' W x 70' L	White	\$252.09	F0-6467100
2228288	(DS-367165V)	36' W x 165' L	White	\$598.89	F0-2291400
2228292	(DS-407100B)	40' W x 100' L	Blue	\$400.09	F0-6008200
2228295	(DS-407100C)	40' W x 100' L	Clear	\$400.09	F0-6008200
2228297	(DS-407100W)	40' W x 100' L	White	\$400.09	F0-6008200
374291	(DS-407149B)	40' W x 149' L	Blue	\$598.89	F0-2291400
374060	(DS-407149W)	40' W x 149' L	White	\$598.89	F0-2291400
205890	(DS-407149C)	40' W x 149' L	Clear	\$598.89	F0-2291400
2228299	(DS-407200W)	40' W x 200' L	White	\$800.09	F0-6006500

SHRINK WRAP - 10 MIL

Order No.	Mfg. No.	Size	Color	List Price	FO
2228209	(DS-2010100W)	20' W x 100' L	White	\$287.49	F0-4210200

SHRINK WRAP - 2 MIL

Order No.	Mfg. No.	Size	Color	List Price	FO
440759	(DS-202200CPS)	20' W x 200' L	Clear	\$87.29	F0-0116000
440760	(DS-324100CPS)	32' W x 100' L	Clear	\$127.59	F0-1398000

Dr. Shrink Measuring Film Width and Determining Support Posts Needed for Structure



RECREATION BOAT - FRONT

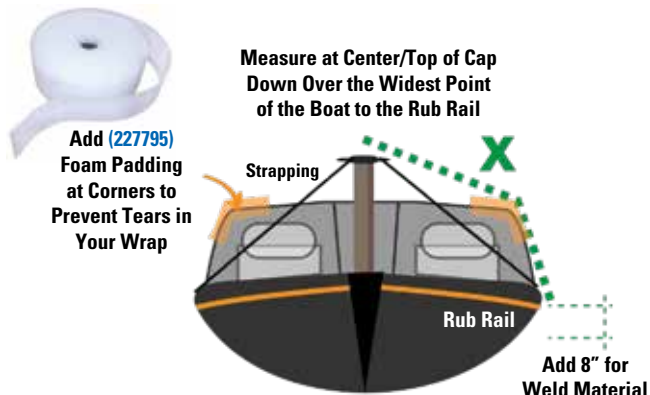

Add (227795) Foam Padding at Corners to Prevent Tears in Your Wrap

Measure at Center/Top of Cap Down Over the Widest Point of the Boat to the Rub Rail

$((X+8'') \times 2) + 2' = \text{ROLL WIDTH}$

RECREATION BOAT - SIDE

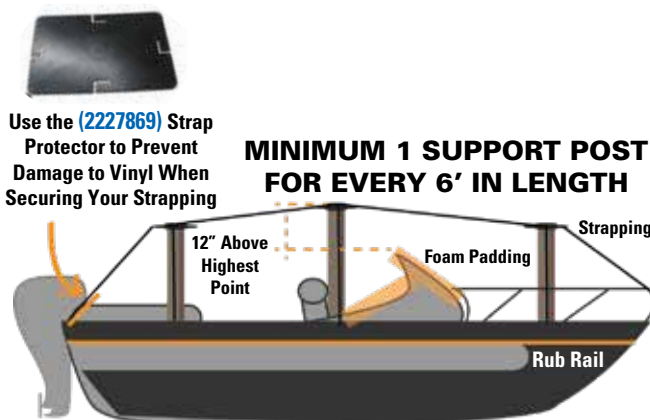

Use the (2227869) Strap Protector to Prevent Damage to Vinyl When Securing Your Strapping

MINIMUM 1 SUPPORT POST FOR EVERY 6' IN LENGTH

PONTOON - FRONT

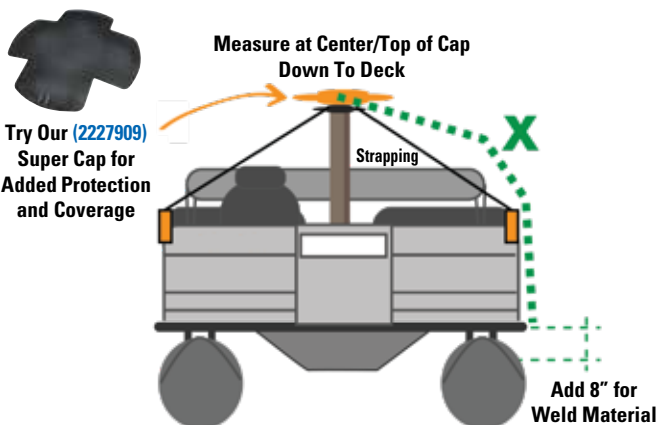

Try Our (2227909) Super Cap for Added Protection and Coverage

Measure at Center/Top of Cap Down To Deck

$((X+8'') \times 2) + 2' = \text{ROLL WIDTH}$

PONTOON - SIDE

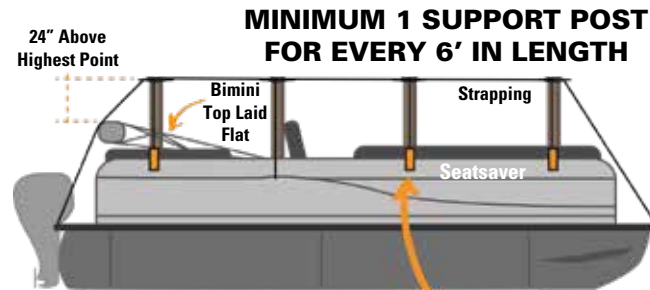

Use the Seatsaver Where Your Seats Come in Contact with the Side Rails. Provides Necessary Lift-Off to Prevent Damage to Your Seats While Also Providing an Ideal Anchor Location for Strapping.

MINIMUM 1 SUPPORT POST FOR EVERY 6' IN LENGTH

RECREATION BOAT VENTING CHART

Length	Beam	Film Size	# of Vents
0' - 16'	7'	12' x 149' (1,788 s.f.)	4
14' - 19'	8'	14' x 128' (1,792 s.f.)	4
17' - 24'	8.5'	17' x 110' (1,870 s.f.)	6
25' - 29'	8.5'	TWO IDEAL SIZES	
	9'	20' x 89' (1,780 s.f.) 24' x 120' (2,880 s.f.)	6
28' - 31'	10'	26' x 100' (2,600 s.f.)	8

PONTOON BOAT VENTING CHART

Length	Beam	Film Size	# of Vents
0' - 16'	8'	17' x 110'	4
16' - 22'	8' - 9'	18' x 200'	6
23' - 28'	8' - 11'	20' x 89'	8

Paint & Paint Acc.

- Electronics
- Trolling Motors
- Instruments
- Electrical
- Lighting
- Anchor & Dock
- Safety
- Steering, Controls
- Pumps
- Fuel System
- Seating & Pedestals
- Trailering
- Tops & Covers
- Perform.
- Propellers
- Engine & Care
- Cleaning & Care
- Paint & Paint Acc.
- Fun & Flotation
- Topside Acc.
- Cockpit & Deck
- Hardware, Fasteners
- Camouflage
- Misc.
- Comm.



**Dr. Shrink Ripack® 3000 Heat Tool**



- 260,000 BTUs.
- The stainless steel nozzle can be turned a full 360° and prevents burns with its cold nozzle system.
- Weighs only 2.7 pounds.
- The kit includes: Heat tool with back-up igniter, 26' propane hose, Securipack - combined fail-safe regulator, high impact plastic case and wrench for tightening fittings.
- One year warranty.

Order No.	Mfg. No. / Description	List Price	
2227881	(DS-RPK3000)	\$1,091.29	FO-0936700

**Dr. Shrink Rebuild Kit for Shrinkfast® 998 Heat Tool**



- Kit includes:
  - (1) #2 O-Ring (DS-998-02)
  - (2) #6 O-Ring (DS-998-06/24)
  - (2) Retainer (DS-998-07)
  - (1) Left Housing w/Label (DS-998-16)
  - (1) Right Housing w/Label (DS-998-15)
  - (1) Trigger/Igniter (DS-998-17/18)
  - (1) Safety (DS-998-20)
  - Assembly Screws (DS-998-29)
  - (1) Button (DS-998-31)
  - (2) #33 O-Ring (DS-998-33)
  - (1) Combustor w/Screen (DS-998-30A).

Order No.	Mfg. No. / Description	List Price	
2228366	(DS-998RB)	\$376.99	FO-9836200

**Dr. Shrink Shrinkfast® 975 Heat Tool**



- 200,000 BTUs.
- Propane fired heat too used to apply heat to shrink wrap.
- Kit includes: Heat tool, 25" propane hose, adjustable regulator, metal carrying case, wrench for tightening fittings and training DVD.

Order No.	Mfg. No. / Description	List Price	
2227893	(DS-SHFAST975)	\$1,170.69	FO-8491800

**Dr. Shrink Shrinkfast® 998 Heat Tool**



- The Shrinkfast 998 is a durable propane powered heat tool that puts out 212,000 BTUs at 22 pounds of pressure.
- The kit includes: Heat tool, 25' propane hose, adjustable regulator, wrench for tightening fittings and a professional training DVD.
- It comes in a plastic carrying case and has a one year warranty.
- Options include 2', 4' and 6' extensions.

Order No.	Mfg. No. / Description	List Price	
279504	(DS-SHFAST998)	\$766.65	ZO-9947500

**Dr. Shrink Shrinkfast® 998 Extension**



- Extensions for the 998 heat tool come in 2', 4' and 6' lengths to get all those hard-to-reach surfaces.
- Repair parts available for all extensions.
- Each sold separately.
- Heat tool and combustion not included.

Order No.	Mfg. No. / Description	List Price	
2227898	(DSSHFAST9982) Length 2'	\$535.79	FO-5057300
2227902	(DSSHFAST9984) Length 4'	\$555.59	FO-1988300
279516	(DSSHFAST9986) Length 6'	\$575.39	FO-7720400

**Dr. Shrink Shrinkfast® 998 Arm Assist Clip**



- The Arm Assist Clip provides the strength and support needed for those tall shrink wrap projects where the 4' or 6' extension is required.
- The lightweight aluminum design will reduce stress on your forearm while allowing for one-handed shrink wrapping.
- The Arm Assist Clip will fit any Shrinkfast 998 heat tool and works with the 4' and 6' extensions.
- Heat tool in picture not included.

Order No.	Mfg. No. / Description	List Price	
2227895	(SHFAST998-AR)	\$138.89	FO-2279000

**Dr. Shrink Rapid Shrink 100 Heat Tool**



- 100,000 BTUs.
- Kit includes: Heat tool, 25' propane hose, adjustable regulator, training DVD, safety gloves, safety glasses and carrying case.

Order No.	Mfg. No. / Description	List Price	
2227888	(DS-RS100)	\$446.49	FO-4521300

**RAPID SHRINK 3' EXTENSION**

Order No.	Mfg. No. / Description	List Price	
2227884	(DS-RS-EXT)	\$99.29	FO-0596000

- Electronics
- Trolling Motors
- Instruments
- Electrical
- Lighting
- Anchor & Dock
- Safety
- Steering, Controls
- Pumps
- Fuel System
- Seating & Pedestals
- Trailering
- Tops & Covers
- Perform.
- Propellers
- Engine & Care
- Cleaning & Care
- Paint & Paint Acc.
- Fun & Flotation
- Topside Acc.
- Cockpit & Deck
- Hardware, Fasteners
- Camouflage
- Misc.
- Comm.

**Dr. Shrink Viking Cylinders Lightweight Composite Propane Tank**



- Finally, an alternative to lugging around those heavy propane cylinders!
- 50% lighter than steel.
- The ergonomic handles allow for easy carrying and stacking.
- Thanks to the rugged, noncorrosive 3-layer composite, your fuel levels will always be visible so you'll never unexpectedly run out on the job.

Order No.	Mfg. No. / Description	List Price	
<b>2227867</b>	(DS-LWTANK-17) 17 lbs.	<b>\$218.29</b>	F0-0825100

**Dr. Shrink Heat Shrink Tape - 9 Mil**

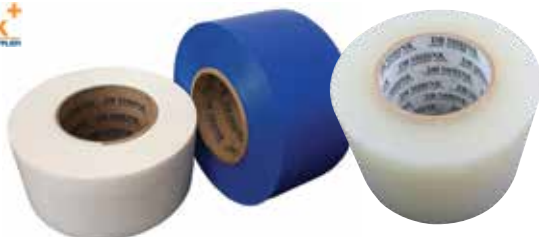

- Heat Shrink Tape is a 9 mil polyethylene tape that is designed to install doors and seal pleats, seams and holes.
- A powerful backing that adheres nicely to shrink wrap.

Order No.	Mfg. No.	Size	Color	List Price	
<b>227909</b>	(DS-702B)	2" x 180'	Blue	<b>\$10.09</b>	F0-6070000
<b>227935</b>	(DS-702W)	2" x 180'	White	<b>\$10.09</b>	F0-6070000
<b>227961</b>	(DS-702C)	2" x 180'	Clear	<b>\$10.09</b>	F0-6070000
<b>2228324</b>	(DS-702PW)	2" x 180'	White (Serrated Edge)	<b>\$10.09</b>	F0-6070000
<b>2228327</b>	(DS-703B)	3" x 180'	Blue	<b>\$15.09</b>	F0-6501000
<b>2228340</b>	(DS-703W)	3" x 180'	White	<b>\$15.09</b>	F0-6501000
<b>227911</b>	(DS-704B)	4" x 180'	Blue	<b>\$20.09</b>	F0-6041000
<b>227947</b>	(DS-704W)	4" x 180'	White	<b>\$19.32</b>	Z0-9441000
<b>227973</b>	(DS-704C)	4" x 180'	Clear	<b>\$20.09</b>	F0-6041000
<b>2228344</b>	(DS-704PW)	4" x 180'	White (Serrated Edge)	<b>\$20.09</b>	F0-6041000
<b>227923</b>	(DS-706B)	6" x 180'	Blue	<b>\$30.09</b>	F0-6012000
<b>227959</b>	(DS-706W)	6" x 180'	White	<b>\$30.09</b>	F0-6012000
<b>227985</b>	(DS-706C)	6" x 180'	Clear	<b>\$30.09</b>	F0-6012000

**Dr. Shrink Anti-Chafe Tape - 3 Mil**



- A high performance polyethylene film that provides a tough, puncture resistant material to prevent abrasion.
- This tape is designed as a low-tack film that will provide protection for your boat or other object.
- Use only between shrink wrap and the object.
- Simply apply it directly to the object where the shrink wrap touches.
- The tape acts as a barrier between the object and shrink wrap, thus preventing any scratching or chafing.
- The black underside of the tape contains UV inhibitors to prevent the sun from drying out the adhesive.

Order No.	Mfg. No.	Size	Color	List Price	
<b>2227833</b>	(DS-CHAFE3)	3" x 1,000'	White	<b>\$45.09</b>	F0-6513000
<b>2227837</b>	(DS-CHAFE66)	6" x 600'	White	<b>\$47.29</b>	F0-0133000
<b>2227835</b>	(DS-CHAFE6)	6" x 1,000'	White	<b>\$75.69</b>	F0-8925000
<b>2227828</b>	(DS-CHAFE126)	12" x 600'	White	<b>\$94.49</b>	F0-4166000
<b>2227825</b>	(DS-CHAFE12)	12" x 1,000'	White	<b>\$151.19</b>	F0-3850100
<b>2227830</b>	(DS-CHAFE24)	24" x 600'	White	<b>\$188.89</b>	F0-2223100

**Dr. Shrink Clear Poly Sheeting - 4 Mil**



- Made from polyethylene which provides optimum in economy and performance.
- It has great weather ability, chemical inertness and toughness which has made it successful in a wide variety of applications.
- Used in construction, industrial and agricultural applications.

Order No.	Mfg. No. / Description	List Price	
<b>2228290</b>	(DS-404100C) 40' W x 100' L	<b>\$222.09</b>	F0-6455100

**Dr. Shrink Light Duty Heat Shrink Tape - 7.5 Mil**



- Light duty heat shrink tape is a 7.5 mil polyethylene tape.
- Serrated edges.

Order No.	Mfg. No.	Size	Color	List Price	
<b>2228320</b>	(DS702.5W-7.5)	2.5" x 180'	White	<b>\$11.29</b>	F0-0970000
<b>2228347</b>	(DS-704WP)	4" x 180'	White	<b>\$20.09</b>	F0-6041000

**Dr. Shrink Preservation Tape - 10 Mil**

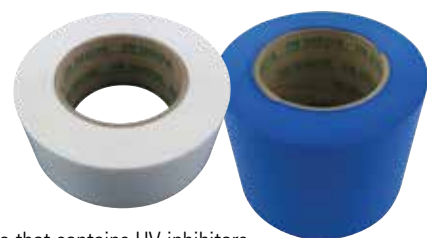

- A 10 mil waterproof tape that contains UV inhibitors for long term storage and leaves minimal adhesive residue.
- Most commonly used for transportation covers where the cover needs to be taped directly to the object.
- PLEASE NOTE: Although preservation tape is designed not to leave a residue, the adhesion is very strong and it is possible that the top layer of paint or finish may come off painted surfaces or wood. Please test a small area before applying to the entire surface.

Order No.	Mfg. No.	Size	Color	List Price	
<b>227997</b>	(DS-712W)	2" x 108'	White	<b>\$11.49</b>	F0-4080000
<b>228002</b>	(DS-713W)	3" x 108'	White	<b>\$17.19</b>	F0-3021000
<b>222801</b>	(DS-714W)	4" x 108'	White	<b>\$22.89</b>	F0-2061000
<b>2228349</b>	(DS-714B)	4" x 108'	Blue	<b>\$22.89</b>	F0-2061000

**3M Preservation Sealing Tape - 4811**

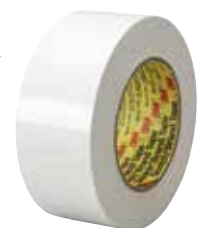

- The conformability and stain resistant properties of this white polyethylene tape offers excellent performance as an industrial and military preservation tape.
- Effective for many outdoor applications in hot and cold weather.
- Used for securing cover films for industrial commercial and marine equipment during storage and transportation.

Order No.	Mfg. No. / Description	List Price	
<b>855410</b>	(62334) 2" x 36 yards	<b>\$66.39</b>	F0-7464000

- Electronics
- Trolling Motors
- Instruments
- Electrical
- Lighting
- Anchor & Dock
- Safety
- Steering, Controls
- Pumps
- Fuel System
- Seating & Pedestals
- Trailering
- Tops & Covers
- Perform.
- Propellers
- Engine & Care
- Cleaning & Care
- Paint & Paint Acc.
- Fun & Flotation
- Topside Acc.
- Cockpit & Deck
- Hardware, Fasteners
- Camouflage
- Misc.
- Comm.

**Dr. Shrink Wrap n' Strap Knife**



- One blade designated to cut strapping and the other blade used to make even, smooth cuts for shrink wrap.
- A combination of our innovative Ring Cutter and Film Knife tools, the Wrap n' Strap Knife is a handy, safe and convenient tool to cut your strapping and shrink wrap with a simple flip of the blade.
- The knife includes two additional blades for easy replacement.

Order No.	Mfg. No. / Description	List Price	
2228121	(DS-008) Wrap n' Strap Knife	\$11.99	F0-9380000
2228124	(DS-008R) Replacement Blades - Pack of 10	\$6.49	F0-4540000

**Dr. Shrink Professional Shrink Wrap Knife**



- Used to safely and smoothly cut shrink wrap during installation.
- No danger of scratching or cutting equipment with blade.

Order No.	Mfg. No. / Description	List Price	
228115	(DS-007) Shrink Wrap Knife	\$11.99	F0-9380000
228118	(DS-007R) Replacement Blades - Pack of 10	\$6.49	F0-4540000

**Dr. Shrink Large Shrink Wrap Knife**



- Large shrink wrap cutting knife.
- Hooked end for safety.
- Replacement blades available.

Order No.	Mfg. No. / Description	List Price	
2228118	(DS-007B)	\$15.89	F0-2111000

**Dr. Shrink Disposable Shrink Wrap Knife**



- Disposable film cutting knife.

Order No.	Mfg. No. / Description	List Price	
228103	(DS-007D)	\$2.29	F0-0610000

**Dr. Shrink Strap Cutting Tool (Ring Cutter)**



- Convenient strap cutting tool that allows the user to safely keep a blade available throughout the shrink wrapping process.
- Cuts woven cord strapping with ease.

Order No.	Mfg. No. / Description	List Price	
2227874	(DS-RCUT)	\$2.59	F0-1810000

**Dr. Shrink Weather Tight Self-Adhesive Vent**



- 4" x 5" self-adhesive, weather tight vent.
- Used to create a waterproof vent in a shrink wrap cover, allowing airflow under the cover, reducing moisture buildup without compromising the covers integrity.
- Scalloped edges with raised walls allow for vertical or horizontal installation.
- Please note: Vents should be applied to warm shrunk film to stick properly.

Order No.	Mfg. No. / Description	List Price	
227719	(DS-683) Black	\$2.19	F0-3510000
2228309	(DS-683W) White	\$2.19	F0-3510000

**Dr. Shrink Solar Powered Vent**



- Allows even more airflow underneath the shrink wrap by using two high speed solar powered fans to actively move air.
- It's water resistant, removes moisture and odors and has easy self-adhesive installation.
- Moves over 150 cubic ft of air per hour at 80% efficiency.

Order No.	Mfg. No. / Description	List Price	
2228307	(DS-683SP W) White	\$33.79	F0-5632000

**Dr. Shrink Wind Powered Weather Tight Vents**



- Wind powered 4" x 5" self-adhesive, weather tight vent.
- Allows airflow underneath the shrink wrap cover by using anemometer cups to spin blades to actively move air even with the slightest breeze.
- Can circulate air 24 hours a day.
- The cups can be rotated to either deliver air or remove it.
- Removable top for easy installation.
- Moves 150 cubic feet per hour with a 10 mph wind speed.

Order No.	Mfg. No. / Description	List Price	
2228312	(DS-683WVP B) Blue	\$7.99	F0-9550000
2228315	(DS-683WVP W) White	\$7.99	F0-9550000

**Dr. Shrink Scoop Vent**



- 12 ml triangular clear plastic vent.
- Provides airflow under shrink wrap to keep covered products moisture free.
- Pack of 6.

Order No.	Mfg. No. / Description	List Price	
2227890	(DS-SCOOP)	\$2.99	F0-9020000



**Dr. Shrink Zipper Access Doors**



- Doors are taped on the cover to allow access into a shrink wrapped object without compromising the durability of the cover.
- Use a film knife to cut the inside of the opening for access into the shrink wrapped object.
- All doors have double-pull zippers.

Order No.	Mfg. No. / Description	List Price
281105	(DS-36B) 30" x 36" Blue	\$9.99 F0-9960000
281206	(DS-36W) 30" x 36" White	\$9.99 F0-9960000
281307	(DS-36C) 30" x 36" Clear	\$9.99 F0-9960000
281319	(DS-48C) 30" x 48" Clear	\$11.99 F0-9380000
281117	(DS-3648B) 36" x 48" Blue	\$11.99 F0-9380000
281120	(DS-3648W) 36" x 48" White	\$11.99 F0-9380000
281118	(DS-3648C) 36" x 48" Clear	\$11.99 F0-9380000
2228351	(DS-72B) 36" x 72" Blue	\$35.79 F0-5052000
2228353	(DS-72C) 36" x 72" Clear	\$35.79 F0-5052000
2228356	(DS-72W) 36" x 72" White	\$35.79 F0-5052000

**Dr. Shrink Heavy Duty Film Rack Cart**



- The heavy duty film rack is built out of black powder coated steel and can hold up to four 200 pound rolls of shrink wrap - along with heat tools, propane tank, strapping and other supplies.
- The rack rolls on the extra large casters with locks for ease of use.
- It is ready to make the installation of shrink wrap much easier for you.
- NOTE: Due to the weight of this item, it must be shipped on a freight truck.

Order No.	Mfg. No. / Description	List Price
2227856	(DS-HDRACK)	\$1,289.69 F0-8720900

**Dr. Shrink Film Rack**



- The side rails are made of square steel tubing measuring 18".
- These rails are perfect for easy mounting on either the floor or the wall.
- The center pole is a 72" long piece of conduit sturdy enough to hold even the largest of shrink wrap rolls.

Order No.	Mfg. No. / Description	List Price
2227851	(DS-FILMRACK)	\$194.49 F0-4163100

**Dr. Shrink Lifting Lug Cover**



- Dr. Shrink has formulated an alternative option for quick & easy access to your lifting points.
- Each Lifting Lug Cover is a 12" x 12" square, made of premium 10-mil shrink wrap and extremely durable and sturdy.
- Each lug cover is easy to install, allowing quick and resealable access to lifting points.

Order No.	Mfg. No. / Description	List Price
2227865	(DSLCCZIPPERW)	\$13.89 F0-2790000

**Dr. Shrink Utility Cart**



- Lightweight two-wheeled Utility Cart with a spot for everything.
- Holds the propane tank, heat tool, hose, strapping, tape, buckles, etc.
- Rolls easily on 8" wheels.
- It will make you more efficient.

Order No.	Mfg. No. / Description	List Price
2228113	(DSUTILITYCAR)	\$644.89 F0-2415400

**Dr. Shrink GoCart**



- Easy assembly - easy takedown!
- This lightweight cart is durable and easy to maneuver.
- Four 8" lockable, rotating wheels make braking and handling a snap.

Order No.	Mfg. No. / Description	List Price
2227854	(DS-GOCART)	\$1,091.29 F0-0936700

- Electronics
- Trolling Motors
- Instruments
- Electrical
- Lighting
- Anchor & Dock
- Safety
- Steering, Controls
- Pumps
- Fuel System
- Seating & Pedestals
- Trailer
- Tops & Covers
- Perform.
- Propellers
- Engine & Care
- Cleaning & Care
- Paint & Paint Acc.
- Fun & Flotation
- Topside Acc.
- Cockpit & Deck
- Hardware, Fasteners
- Camouflage
- Misc.
- Comm.

**Dr. Shrink Heavy Duty Woven Cord Strapping**



- Used with wooden uprights and buckles to form the support structure under shrink wrap covers.
- It is also used to create the perimeter band that will secure the shrink wrap material.

Order No.	Mfg. No.	Size	Break Strength	List Price	
2228302	(DS-500HD)	1/2" x 3,900'	900 lb.	<b>\$107.99</b>	F0-9557000
2228305	(DS-50015HD)	1/2" x 1,500'	900 lb.	<b>\$48.99</b>	F0-9243000
2228359	(DS-750HW)	3/4" x 1,665'	1,625 lb.	<b>\$112.99</b>	F0-9097000
2228361	(DS-7501500)	3/4" x 1,500'	900 lb.	<b>\$63.69</b>	F0-8544000
2228364	(DS-750300)	3/4" x 300'	900 lb.	<b>\$20.49</b>	F0-4341000

**Dr. Shrink Strap Dispenser**



- Durable and lightweight design which is compatible with all our premium 1/2" and 3/4" strapping rolls.
- The unit features a convenient carrying handle and low resistance spindle system.
- Ideal tool to prevent knots, tangles and twists in the strapping.

Order No.	Mfg. No. / Description	List Price	
2227907	(DS-STRAPDISP)	<b>\$37.79</b>	F0-5462000

**Dr. Shrink Strapping Protector**



- Designed for two different applications:
  - 1) A method of keeping strapping from forming dents in vinyl upholstery on boats.
  - 2) Used as corner guards to keep shrink wrap and strapping from being cut on sharp edges.
- Notched on all four sides for easy attachment to strapping.

Order No.	Mfg. No. / Description	List Price	
2227869	(DS-PROTECTOR)	<b>\$2.09</b>	F0-6410000

**Dr. Shrink Super Cap**



- Designed to transfer the weight of snow, ice and rain from the top of 2 x 4 support poles used under shrink wrap storage covers.
- Dome shaped and 20" in diameter, the Super Cap rests on the woven cord strapping running both lengthwise and crosswise, thus minimizing support poles from poking through shrink wrap covers.
- Super Caps can be easily attached to wooden uprights with either a nail or staples.

Order No.	Mfg. No. / Description	List Price	
2227909	(DS-SUPERCAP)	<b>\$4.29</b>	F0-0030000

**Dr. Shrink End Caps and Bottom Caps**



- Designed to fit on the top and bottom of 2 x 4 boards commonly used as a support poles under shrink wrap covers.
- The caps have slits every 90° for the woven cord strapping to slide into and when the cover is shrunk, the sections flex downward forming a protective pad on the top to eliminate pole poke-through. Bottom caps have non-skid disks attached for added stability.

Order No.	Mfg. No. / Description	List Price	
2227757	(DS-CAP) End Caps	<b>\$1.49</b>	F0-4010000
2227767	(DS-BCAP) Bottom Caps	<b>\$2.89</b>	F0-2020000

**Regular Woven Cord Strapping**

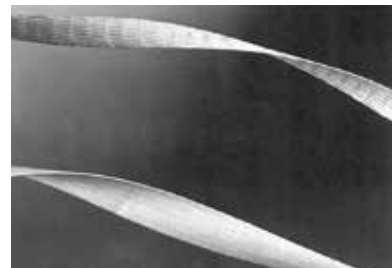

- Can be hand tied or secured and fastened with buckles.

Order No.	Mfg. No.	Size	Tensile	List Price	
427700	(P40RW15)	1/2" x 1,500'	650 lb.	<b>\$66.49</b>	L0-5233000
427715	(P40RW)	1/2" x 3,900'	650 lb.	<b>\$157.89</b>	L0-5987000
427730	(P60RW)	3/4" x 2,100'	950 lb.	<b>\$141.99</b>	L0-0017000

**Dr. Shrink Tensioning Tool**



- Used when creating the perimeter band.
- If the perimeter band is left only hand tightened, the cover will sit loosely over the object and can rub and chafe the object.
- A band properly tightened with the Tensioning Tool will create a powerful perimeter band that will hug the cover securely against the protected object, preventing movement and eliminating chafing.

Order No.	Mfg. No. / Description	List Price	
227858	(DS-15)	<b>\$70.89</b>	F0-2694000

**Dr. Shrink Metal Buckles**



- Used with the strapping and tensioning tool when creating a tight-fitting perimeter band.
- When creating the support structure, the buckles allow the installer to sufficiently hand tighten the strapping and produce a sturdy, sloping frame for the shrink wrap cover.
- 3/4" Heavy duty.
- Sold 100 per bag.

Order No.	Mfg. No. / Description	List Price	
227846	(DS-075)	<b>\$17.89</b>	F0-2521000

**Dr. Shrink Liffoff Assembly**



- The Liffoff is perfect for wrapped objects that need additional ventilation as well as surface protection (such as painted boat hulls or delicate machinery) during the wrapping process.

Order No.	Mfg. No. / Description	List Price	
2227859	(DS-LIFTOFF)	<b>\$2.09</b>	F0-6410000

**Dr. Shrink Foam Block**



- 3" x 2" x 22" foam block.
- Sold individually.

Order No.	Mfg. No. / Description	List Price
<b>2227845</b>	(DS-FBLOCK)	<b>\$2.99</b> F0-9020000

**Dr. Shrink Easy Klips®**



- Can reduce labor time by holding shrink wrap securely in place.
- Makes the shrink wrap process easier.
- Easy on/easy off application and fastens in seconds.
- Will not detach until you want it to.
- Instead of pulling off when the load gets heavy, the EasyKlip will actually clamp down harder and fastens without tearing the plastic.

Order No.	Mfg. No. / Description	List Price
<b>2227840</b>	(DS-EASYKLIPB) Blue	<b>\$2.49</b> F0-4710000
<b>2227842</b>	(DS-EASYKLIPW) White	<b>\$2.49</b> F0-4710000

**Dr. Shrink REBAG System - Roll of 50**



- This program is available throughout the Continental U.S. for recycling shrink wrap.
- All you have to do is put your used shrink wrap covers or scraps into the bag, close it, put the prepaid FedEx label on it and then call FedEx for a pickup or take it to the nearest FedEx service center.
- This product is a roll of 50 REBAGS.
- One individual REBAG holds approximately 600 square feet of plastic

Order No.	Mfg. No. / Description	List Price
<b>2227872</b>	(DS-RBAG)	<b>\$2,976.19</b> F0-3338020

**Dr. Shrink Fuel Vent Cap**



- Cap for covering the fuel vent while shrink wrapping.

Order No.	Mfg. No. / Description	List Price
<b>2227848</b>	(DS-FCAP)	<b>\$1.59</b> F0-1110000

**Dr. Shrink Training DVD**

- Dr. Shrink's training DVD.
- Included in each heat tool kit.

Order No.	Mfg. No. / Description	List Price
<b>2228115</b>	(DS-0015CD)	<b>\$29.79</b> F0-5802000

**Dr. Shrink Foam Padding**



- Covers sharp corners and edges from puncturing through your shrink wrap cover.
- 1/4" thick foam padding.
- 6" x 75' roll.

Order No.	Mfg. No. / Description	List Price
<b>2227795</b>	(DS-675F)	<b>\$23.39</b> F0-7361000

**Dr. Shrink Long Cuff Safety Gloves**



- Long cuff safety gloves designed to be used with heat tools.
- Long cuff protects wrists and clothing.
- Non-flammable, safe to use with open flame of heat tool.

Order No.	Mfg. No. / Description	List Price
<b>281150</b>	(DS-009) White	<b>\$9.27</b> Z0-5960000

**Dr. Shrink TideMinder® Kits**



- TideMinder kit - set of 9 balls.
- Each ball measures 3" and the center hole will accept up to a 1" line (inner dimension of hole is 1.25").
- Line is not included with kit.

Order No.	Mfg. No. / Description	List Price
<b>2228108</b>	(DS-TMKITBK) Black	<b>\$55.59</b> F0-1983000
<b>2228110</b>	(DS-TMKITW) White	<b>\$55.59</b> F0-1983000

**REPLACEMENT BALLS**

Order No.	Mfg. No. / Description	List Price
<b>2228102</b>	(DS-TMBALLBK) Black	<b>\$9.99</b> F0-9960000
<b>2228105</b>	(DS-TMBALLW) White	<b>\$9.99</b> F0-9960000

- Electronics
- Trolling Motors
- Instruments
- Electrical
- Lighting
- Anchor & Dock
- Safety
- Steering, Controls
- Pumps
- Fuel System
- Seating & Pedestals
- Trailering
- Tops & Covers
- Perform.
- Propellers
- Engine & Care
- Cleaning & Care
- Paint & Paint Acc.
- Fun & Flotation
- Topside Acc.
- Cockpit & Deck
- Hardware, Fasteners
- Camouflage
- Misc.
- Comm.





**Lifesafe Marine Grade Boat Striping Tape**



- Premium marine grade for extra-long life.
- Decorative, self-adhesive trim.
- Durable and easy to apply.
- Conveniently packaged in 1" and 2" widths.
- 50 feet in length.

**Blue Mask Marine Masking Tape**



- SmartSkin technology for clean, crisp paint lines.
- Quality crepe paper.
- 14-day clean removal.
- Multi-surface.
- UV resistant. Solvent-free.
- EasyTEAR.
- Medium tack.

Order No.	Mfg. No. / Description	List Price
812328	(TP BDT 0100) 1" x 60 yds. 36 Rolls Per Case	\$6.39 H0-3830000
812330	(TP BDT 0200) 1-7/8" x 60 yds. 24 Rolls Per Case	\$12.09 H0-5270000

**3M Scotch® Delicate Surface Painter's Masking Tape - 2080**



- Gentle adhesive.
- UV and sunlight resistant (intended for indoor use only).
- 60-day clean removal leaves behind no damage or sticky residue.
- Designed for use on delicate surfaces such as painted drywall, freshly painted walls, wood floors, wallpaper, veneers and cabinets (painted at least 24 hours ago).

Order No.	Mfg. No. / Description	List Price
855520	(79748) 1" x 60 yds. 36 Rolls Per Case	\$7.39 FO-7150000
855532	(79750) 1-7/8" x 60 yds. 24 Rolls Per Case	\$14.79 FO-5301000

**3M Scotch® General Purpose Masking Tape - 2050**



- Medium adhesive.
- Designed for use on painted walls, vinyl, carpet, metal and plastic.
- 5-day clean removal leaves behind no damage or sticky residue.

Order No.	Mfg. No. / Description	List Price
855126	(05617) 3/4" x 60 yds. 48 Rolls Per Case	\$2.59 FO-1810000
855138	(05618) 1" x 60 yds. 36 Rolls Per Case	\$3.49 FO-4420000
855164	(05620) 1-7/8" x 60 yds. 24 Rolls Per Case	\$7.09 FO-6940000

**3M ScotchBlue™ Original Multi-Surface Masking Tape - 2090**



- Medium adhesive.
- UV and sunlight resistant.
- Designed for use on multiple surfaces such as smooth or lightly textured walls, trim, baseboards, tile and glass.
- 14-day clean removal leaves behind no damage or sticky residue.

Order No.	Mfg. No. / Description	List Price
855481	(03680) 3/4" x 60 yds. 48 Rolls Per Case	\$3.89 FO-2720000
855493	(09171) 1" x 60 yds. 36 Rolls Per Case	\$4.99 FO-9430000
855506	(09221) 1-1/2" x 60 yds. 24 Rolls Per Case	\$7.49 FO-4250000
855518	(09168) 1-7/8" x 60 yds. 24 Rolls Per Case	\$9.89 FO-2960000

**3M Scotch® Solvent Resistant Masking Tape - 2040**



- Sticks easily to the surface and helps lifting and/or curling/helps reduce labor.
- Helps resist lifting/rework.
- Easy handling/helps reduce overall project time.
- Note: Not for extended outdoor use.

Order No.	Mfg. No. / Description	List Price
855203	(02992) 1" x 60 yds. 36 Rolls Per Case	\$5.89 FO-2140000
855215	(02993) 1-1/2" x 60 yds. 24 Rolls Per Case	\$8.59 FO-1060000
855239	(04365) 1-7/8" x 60 yds. 24 Rolls Per Case	\$11.39 FO-7970000

**3M Scotch® Performance Green Masking Tape - 233+**



- A highly conformable that provides the best adhesive transfer resistance, hugs curves, contours and provides outstanding paint lines.
- Goes on quickly and easily, sticks at a touch and stays put.
- Perfectly balanced to give outstanding masking results.

Order No.	Mfg. No. / Description	List Price
855179	(26334) 3/4" x 60 yds. 48 Rolls Per Case	\$5.49 FO-4830000
855178	(26336) 1" x 60 yds. 24 Rolls Per Case	\$7.59 FO-1350000
855177	(26338) 1-1/2" x 60 yds. 16 Rolls Per Case	\$10.99 FO-9670000
855140	(26340) 1-7/8" x 60 yds. 12 Rolls Per Case	\$14.69 FO-8201000

- Electronics
- Trolling Motors
- Instruments
- Electrical
- Lighting
- Anchor & Dock
- Safety
- Steering, Controls
- Pumps
- Fuel System
- Seating & Pedestals
- Trailing
- Tops & Covers
- Perform.
- Propellers
- Engine & Care
- Cleaning & Care
- Paint & Paint Acc.
- Fun & Flotation
- Topside Acc.
- Cockpit & Deck
- Hardware, Fasteners
- Camouflage
- Misc.
- Comm.

3M Highland™ Masking Tape - 2727



- A tan, smooth crepe paper treated with a heat and solvent resistant saturant, using a rubber- based adhesive.
- An automotive refinish masking tape designed with balanced construction for consistent unwind, conformability and easy tear.
- High adhesion ideal for most masking applications.

Order No.	Mfg. No. / Description		List Price	
855320	(06544) 1" x 60 yds.	24 Rolls Per Case	\$7.29	F0-0150000
855322	(06543) 1-7/8" x 60 yds.	24 Rolls Per Case	\$13.49	F0-4490000



3M Scotch® Fine Line Tape - 218



- A high performance masking tape with low profile and high adhesion provides excellent paint lines.
- A polypropylene plastic film with a rubber adhesive.
- Commonly used for two-tone applications.
- The special processed film backing stretches easily for smooth curves yet can be easily torn by hand.
- Excellent moisture and solvent resistance.
- Note: Not designed for outdoor application.

Order No.	Mfg. No. / Description		List Price	
855330	(06301) 1/4" x 60 yds.	12 Rolls Per Case	\$21.49	F0-4051000
855227	(04698) 1/2" x 60 yds.	72 Rolls Per Case, Bulk	\$16.39	F0-7411000
855378	(04699) 3/4" x 60 yds.	48 Rolls Per Case, Bulk	\$21.89	F0-2351000
855380	(04700) 1" x 60 yds.	36 Rolls Per Case, Bulk	\$27.39	F0-7191000



3M Outdoor Masking Poly Tape - 5903



- A poly tape comprised of heavy duty polyethylene film & synthetic rubber adhesive.
- It is UV weather resistant and removes cleanly for up to one month with little or no adhesive residue on most opaque surfaces without deteriorating or fading.
- Clean removal up to 30 days outdoors.
- Moisture resistant tape.
- Red color for good visibility

Order No.	Mfg. No. / Description		List Price	
855675	(31842) 1-7/8" x 60 yds.	24 Rolls Per Case	\$14.19	F0-3990000



3M Scotch® Shipping Packaging Tape - 3750



- Strong conformable film backing and hot melt synthetic rubber-resin adhesive system provides a consistent uniform seal.
- Resists center seam splitting, assures reliable closures.
- Seals out moisture, dust and dirt.

Order No.	Mfg. No. / Description		List Price	
855657	(91765) 1-7/8" x 60 yds.	36 Rolls Per Case	\$7.09	F0-6940000



Lifesafe Super Seal Emergency Repair Tape



- Emergency repairs, stops leaks, forms solid rubber wrap.
- Strips clean, leaves no messy adhesive or residue.
- Holds 100 psi at 220° F.
- Works wet, dry, greasy or dirty.
- Shrinks about 3% to form an airtight, waterproof seal.

Order No.	Mfg. No. / Description		List Price	
228270	(RE3869) 1" x 16'		\$12.89	F0-2090000



Lifesafe Sail Patch Repair Tape



- Super clear U.V. stabilized.
- Excellent resistance to tearing in any direction, very aggressive adhesive, works on damp sails.
- Transparent color suitable for any sail.
- Tape is light weight and flexible.

Order No.	Mfg. No. / Description		List Price	
228243	(RE3843) 3" x 15'		\$16.49	F0-4511000



Handi-Man Self-Bonding Rigging and Insulating Tape



- Shrinks to a waterproof seal as you wrap.
- Remove cleanly, no solvents needed.
- Leaves no residue.
- Water and ozone resistant.
- Adheres to itself when stretched.
- Excellent insulator against harsh environments.

Order No.	Mfg. No. / Description		List Price	
731515	(960027) 1" x 10" Black		\$8.99	H0-9350000
731520	(960028) 1" x 10" White		\$9.09	H0-5450000



- Electronics
- Trolling Motors
- Instruments
- Electrical
- Lighting
- Anchor & Dock
- Safety
- Steering, Controls
- Pumps
- Fuel System
- Seating & Pedestals
- Trailering
- Tops & Covers
- Perform.
- Propellers
- Engine & Care
- Cleaning & Care
- Paint & Paint Acc.
- Fun & Flotation
- Topside Acc.
- Cockpit & Deck
- Hardware, Fasteners
- Camouflage
- Misc.
- Comm.



- Electronics
- Trolling Motors
- Instruments
- Electrical
- Lighting
- Anchor & Dock
- Safety
- Steering, Controls
- Pumps
- Fuel System
- Seating & Pedestals
- Trailer
- Tops & Covers
- Perform.
- Propellers
- Engine & Care
- Cleaning & Care
- Fun & Flotation
- Topside Acc.
- Cockpit & Deck
- Hardware, Fasteners
- Camouflage
- Misc.
- Comm.

Silver Duct Tape



- Waterproof tape.
- Maximum adhesion and strength.
- EasyTEAR backing.
- New and improved - 4 layers.
- Multi-surface. Interior and exterior.
- 24 rolls per case.

Order No. Mfg. No. / Description List Price  
**855582** (TP DUCT IND) 1-7/8" x 60 yds. **\$12.09** HO-5270000

3M Hand Masker™ Pre-Folded Masking Film



855897

855873

855859

- Film is treated to resist overspray flaking during multiple coat applications.
- Rolls are dispensed and applied using the 3M Hand Masker M3000 Dispenser.
- Lets light in so work can proceed when there is minimal or no artificial light.
- Ideal when preparing for multi-coat paint, lacquer, undercoaters and industrial coating applications.

Order No.	Mfg. No. / Description	List Price
<b>855859</b> (95255)	24" x 180' MF24	<b>\$8.09</b> F0-6650000
<b>855873</b> (90038)	48" x 180' MF48	<b>\$16.09</b> F0-6211000
<b>855897</b> (90039)	72" x 90' MF72	<b>\$12.09</b> F0-6480000
<b>855899</b> (90040)	99" x 90' MF99	<b>\$16.59</b> F0-1611000

Masking Paper

Order No.	Mfg. No. / Description	List Price
<b>440800</b> (140736)	36" x 400'	<b>\$64.39</b> HO-3683000

3M Hand Masker™ Pre-Taped Plastic Drop Cloth



- Pre-folded high density plastic drop cloth pre-taped with 3M Scotch 2090 Long-Mask tape.
- Plastic folds out to 35 inches.
- Protects various surfaces while painting.

Order No. Mfg. No. / Description List Price  
**855900** (34065) 24" x 25 yds. **\$7.39** F0-7150000  
**855901** (34067) 48" x 25 yds. **\$9.49** F0-4660000

3M Hand Masker™ Premium Quality Masking Paper - MP18



- Designed to minimize bleed-through.
- Use on the 3M Hand Masker M3000 Dispenser.

Order No. Mfg. No. / Description List Price  
**855772** (06904) 18" x 60 yds. 12 Rolls Per Case **\$6.69** F0-8640000



MarineMart Motor Boat Stands



- The strongest, longest lasting boat stand.
- Hot dipped galvanized base resists rust for a long, long time. Much longer than a painted stand.
- Hot dipped galvanized top, no bare steel that rusts in days.
- Solid Acme threaded rod - not hollow, for a higher load capacity.
- 316 stainless steel hardware, through-bolted to plywood. No screws that strip.
- Brownell pattern match, nearly identical part number, mix and match ours and theirs for a seamless transition.
- Certified third party load tested, ScaffoldMart has been in load-bearing steel for years.

Order No.	Mfg. No.	Height		List Price	
480900	(MBS-0)	41" - 58"	Orange Galv. Long Top	\$139.19	E0-9340100
480903	(MBS-1)	33" - 50"	Orange Galv. Long Top	\$129.29	E0-7969000
480906	(MBS-2)	28" - 46"	Orange Galv. Long Top	\$126.69	E0-2059000
480909	(MBS-3)	25" - 38"	Gray Galv. Medium Top	\$122.79	E0-9029000

MOTOR BASE STANDS BASE ONLY

Order No.	Mfg. No.	Height		List Price	
480901	(MBS-0BASE)	41" - 58"		\$77.69	E0-7285000
480904	(MBS-1BASE)	33" - 50"		\$67.89	E0-2905000
480907	(MBS-2BASE)	28" - 46"		\$65.19	E0-9884000
480910	(MBS-3BASE)	25" - 38"		\$61.29	E0-7954000

MarineMart Boat Stand Tops



- We hot dip galvanize our top in three individual pieces, for maximum coverage and protection against corrosion.
- Our marine-grade plywood is through bolted to it's galvanized backings plate, not screwed.
- Our tops are fastened with 316L stainless steel bolts and with nylon backing nuts, for strength and longevity.
- Our rod to backing plate connection is slotted, so weight rests on the solid steel rod, not the bolt.
- Our solid-steel rod is precision ACME threaded, providing increased adjustability under load.
- Increased length of wing nut collar, increased contact area provides increased strength.

Order No.	Mfg. No. / Description	Color	List Price	
480902	(BS-TOPL) 26"	Orange	\$61.49	E0-2164000
480911	(BS-TOPM) 23"	Gray	\$61.49	E0-2164000

MarineMart Sail Boat Stands



- The strongest, longest lasting boat stand.
- Hot dipped galvanized base resists rust for a long, long time.
- Much longer than a painted stand.
- Hot dipped galvanized top, no bare steel that rusts in days.
- Solid Acme threaded rod - not hollow, for a higher load capacity.
- 316 stainless steel hardware, through-bolted to plywood. No screws that strip.
- Brownell pattern match, nearly identical part number, mix and match ours and theirs for a seamless transition.
- Certified third party load tested, ScaffoldMart has been in load-bearing steel for years.

Order No.	Mfg. No.	Height		List Price	
480930	(SBS-1)	64" - 79"	Orange Galv. Long Top	\$176.19	E0-4123100
480933	(SBS-2)	48" - 65"	Orange Galv. Long Top	\$159.59	E0-9691100
480936	(SBS-3)	35" - 52"	Orange Galv. Long Top	\$136.59	E0-4420100

SAIL BASE STANDS BASE ONLY

Order No.	Mfg. No.	Height		List Price	
480931	(SBS-1BASE)	64" - 79"		\$114.79	E0-9068000
480934	(SBS-2BASE)	48" - 65"		\$98.19	E0-4637000
480937	(SBS-3BASE)	35" - 52"		\$75.09	E0-2365000

MarineMart Replacement Plywood for Boat Stands



- Hardware not included.

Order No.	Mfg. No.	Color	List Price	
480920	(RPBS-O)	Orange	\$15.19	E0-9311000
480925	(RPBS-B)	Blue	\$15.19	E0-9311000

MarineMart Heavy Duty Pontoon Dolly



- Dimensions: 26-1/2" L x 24-1/2" W x 11-1/2" H.
- Bunk size: 8-1/4".
- Weight: 65 lbs.

Order No.	Mfg. No. / Description	List Price	
480965	(PD-HD)	\$326.69	E0-2054200



SPECIAL HANDLING MAY APPLY



- Electronics
- Trolling Motors
- Instruments
- Electrical
- Lighting
- Anchor & Dock
- Safety
- Steering, Controls
- Pumps
- Fuel System
- Seating & Pedestals
- Trailering
- Tops & Covers
- Perform.
- Propellers
- Engine & Care
- Cleaning & Care
- Paint & Paint Acc.
- Fun & Flotation
- Topside Acc.
- Cockpit & Deck
- Hardware, Fasteners
- Camouflage
- Misc.
- Comm.

- Electronics
- Trolling Motors
- Instruments
- Electrical
- Lighting
- Anchor & Dock
- Safety
- Steering, Controls
- Pumps
- Fuel System
- Seating & Pedestals
- Trailer
- Tops & Covers
- Perform.
- Propellers
- Engine & Care
- Cleaning & Care
- Paint & Paint Acc.
- Fun & Flotation
- Topside Acc.
- Cockpit & Deck
- Hardware, Fasteners
- Camouflage
- Misc.
- Comm.

**MarineMart Keel Stands**



480945

- Hot dipped base.
- Hot dipped galvanized top.
- Longer thicker wingnut collar - 1/2" length.
- With rubber billet.

Order No.	Mfg. No. / Description	List Price	
480943	(K3-KS) 23" - 35"	\$132.39	E0-9299000
480948	(K4-KS) 16" - 23"	\$110.39	E0-9728000

**GALVANIZED KEEL STAND (BASE ONLY)**

Order No.	Mfg. No. / Description	List Price	
480940	(KS-2BASE) K2 Keel Stand	\$98.99	E0-4247000
480944	(KS-3BASE) K3 Keel Stand	\$67.39	E0-4505000
480949	(KS-4BASE) K4 Keel Stand	\$45.39	E0-4043000

**KEEL STAND TOP ONLY**

Order No.	Mfg. No. / Description	List Price	
480942	(VTOPHD13) Length 13" - Heavy Duty V-Top	\$73.59	E0-9155000
480945	(VTOPHD23) Length 23" - Heavy Duty V-Top	\$73.59	E0-9155000
480950	(KS-TOP13) Length 16"	\$64.99	E0-4784000
480952	(KS-TOP23) Length 23"	\$64.99	E0-4784000

**Attwood Pontoon Storage Blocks**



- UV-resistant material for long-lasting durability.
- Discover hassle-free storage with our lightweight and extra-strong pontoon blocks.
- Designed with special features for added stability and convenience, each storage block can hold up to 4,000 pounds.
- Drainage channels and holes prevent water from pooling against your pontoon.
- The bottom has a molded-in texture to ensure maximum grip on concrete or ground surfaces, while the pre-drilled holes make fastening or staking easy.
- Dimensions: 13-1/2" x 13-1/2" x 9-1/2".
- Sold as set of four.

Order No.	Mfg. No. / Description	List Price	
237750	(11401-4)	\$90.49	F0-4336000

**MarineMart Boat Rack Systems**



480970

480975

- Scaffoldmart's boat rack system is designed to secure vessels in the air for maintenance or repair.
- Our boat rack system consists of stern rack and a bow rack.
- The stern of the vessel rests on the stern rack nestled between the two heads, on thick plastic inserts to resist damage, with the keel between them.
- Our bow rack, on which the keel rests, is positioned towards the front of the boat, and is topped with carpet for damage resistance.
- Add additional boat stands when necessary for additional security, especially with larger boats.

Order No.	Mfg. No. / Description	List Price	
480970	(BR16) Bow Rack - 16"	\$265.79	E0-4399100
480975	(SR20) Stern Rack - 20" H x 41" W	\$393.69	E0-7259200

**MarineMart Boat Dolly**



- Our heavy duty Boat Dolly comes with high quality non-marking casters and non-marking rubber heads.
- Most manufacturers cut and weld a v-rib in two or more pieces and splice them together by welding.
- We think that hydraulically forming the v-rib where the bottom and the top are pressed into a shape that has a radius on both sides is just a higher quality way to do this. It's a much higher quality way to manufacture a dolly.
- So we took the time and expense to have the v-ribs hydraulically pressed for strength and rigidity, not welded like most.
- Two adjustment positions for the pad head, this helps you be able to miss a stake.
- Capacity: 6,700 lbs.

Order No.	Mfg. No. / Description	List Price	
480960	(BDM6700)	\$612.09	E0-7095400

**SPECIAL HANDLING MAY APPLY**

