

Catálogo de accesorios Náuticos



Perform.



Propellers



Engine
& Care



Cleaning
& Care



Paint &
Paint Acc.



Fun &
Flotation



Topside
Acc.



Cockpit
& Deck



Hardware,
Fasteners



Camouflage



Misc.



Comm.



Parte 2

2021

El Navegante

www.repuestoselnavegante.com



- Trolling Motors
- Instruments
- Electrical
- Lighting
- Anchor & Dock
- Safety
- Steering, Controls
- Pumps
- Fuel System
- Seating & Pedestals
- Trailer
- Tops & Covers
- Perform.
- Propellers
- Engine & Care
- Cleaning & Care
- Paint & Paint Acc.
- Fun & Flotation
- Topside Acc.
- Cockpit & Deck
- Hardware, Fasteners
- Camouflage
- Misc.
- Comm.

Bienvenidos a Repuestos El Navegante.

Aquí podrás encontrar mas de **35.000** productos de diferentes fabricantes, con una gran variedad de accesorios y componentes para tu embarcación, contamos con mas de 20 años de experiencia en el sector náutico, no dudes en contactarnos para aclarar cualquier duda que tengas, prestamos asesoría técnica lo que es un valor agregado, y te dará tranquilidad a la hora de tomar una decisión de compra.

Nota Importante:

Debido a las restricciones causadas por el Covid 19, y otros problemas a nivel Mundial muchas empresas se vieron afectadas debido a la falta de materia prima, por este motivo tanto los precios como las fechas de entrega sufrieron cambios en gran cantidad de productos, comuníquese con nosotros a través del correo: repuestoselnavegante@gmail.com y solicite su presupuesto sin compromiso, también puede comunicarse vía Telegram o WhatsApp escaneando los códigos QR.

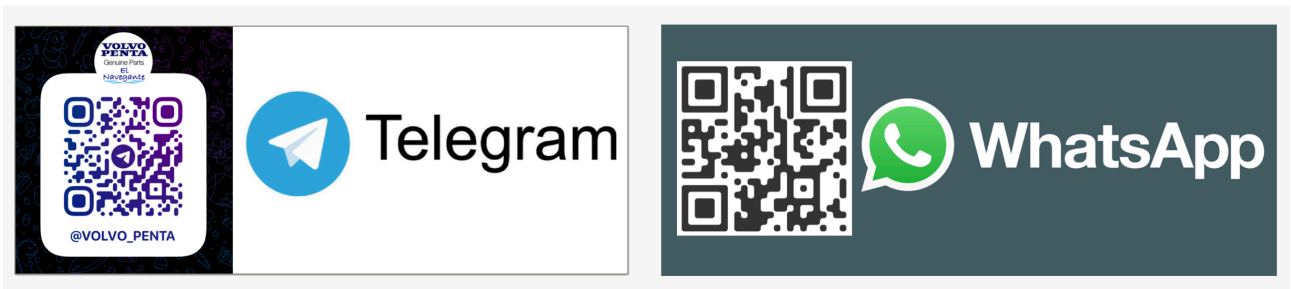

Los productos aquí publicados se encuentran en varias partes del mundo, pero la mayoría se encuentran en Estados Unidos y Europa, por lo que estos precios no incluyen gastos de envío.

También puede consultar en nuestra pagina www.repuestoselnavegante.com nuestros términos y condiciones antes de efectuar la compra, ahí podrá ver también nuestra política de devoluciones.

Los productos pueden ser entregados en un currier de su confianza.

En nuestra pagina podrá encontrar mas de **3.500** productos para entrega inmediata.

Nos especializamos en repuestos Volvo Penta, Cummings, Yanmar, Caterpillar, Mercruiser.

Ofrecemos repuestos para Generadores Onan, Kohler, Westerbeke, Fisher Panda y Northern Lights.

Star Brite Sea Safe Boat Wash



- Environmentally friendly, biodegradable formula.
- Cleans away dirt, stains, grease, oil and salt.
- Use on fiberglass, metal, glass, rubber and painted surfaces.
- Concentrated for heavy duty cleaning.
- Will not remove wax or polish.
- Low Sudsing formula saves water.

Order No.	Mfg. No.	Size	List Price
624802	(89732)	32 fl. oz.	\$11.99

Star Brite Boat Wash in a Bottle



- Biodegradable.
- Leaves hulls, decks, chrome and fittings sparkling.
- Concentrated; a few capfuls clean a 20' boat.
- Non-streaking, does not leave residue.
- Will not remove wax or polish.

Order No.	Mfg. No.	Size	List Price
624800	(80416)	16 fl. oz.	\$6.89
624812	(080400N)	Gallon	\$34.49

Star Brite Power Pine Boat Wash



- Concentrated formula makes 96 gallons (32 fl. oz. size) or 384 gallons (1 gallon size).
- Works in fresh or salt water.
- Environmentally safe, biodegradable.
- Cleans fiberglass, painted surfaces, fish boxes, windows, canvas, brightwork, etc.

Order No.	Mfg. No.	Size	List Price
629759	(93732)	32 fl. oz.	\$17.09
629761	(93700)	Gallon	\$44.79

Star Brite Power Pine Wash and Wax



- Concentrated formula makes 96 gallons (32 fl. oz. size) or 384 gallons (1 gallon size).
- Works in fresh or salt water.
- Environmentally safe, biodegradable.
- Use to clean, shine and protect all fiberglass, painted surfaces, glass, plastic and metals.

Order No.	Mfg. No.	Size	List Price
629836	(94732)	32 fl. oz.	\$18.19
629848	(94700)	Gallon	\$51.59

Star Brite Super Orange Citrus Boat Wash



- Removes dirt, oil and grease from fiberglass, metal and painted surfaces.
- Biodegradable.
- Concentrated for economical use.
- Will not remove wax or polish.
- Works in fresh and salt water.

Order No.	Mfg. No. / Description	Size	List Price
624820	(094532)	32 fl. oz.	\$13.29
624822	(094500N)	Gallon	\$40.99

Star Brite Non-Skid Deck Cleaner



- Safe to use, contains no harsh chemicals.
- Leaves a protective coating to repel dirt and stains.
- A very effective, all-surface cleaner for fiberglass, vinyl, plastic, metal and painted surfaces.

Order No.	Mfg. No.	Size	List Price
625615	(085922P)	22 fl. oz.	\$10.39
625612	(85932)	32 fl. oz.	\$12.09
625609	(085900N)	Gallon	\$31.69

Star Brite Non-Skid Deck Wax



- Applying a polish or wax would make them slippery and dangerous, which is why Star Brite developed Non-Skid Deck Wax.
- Provides a non-slippery barrier against stains and UV exposure.
- Helps restore luster to fiberglass decks.
- Protects painted surfaces, too.

Order No.	Mfg. No.	Size	List Price
625620	(097316)	16 fl. oz.	\$14.49

Star Brite Inflatable Boat and Fender Cleaner



- Heavy duty formula removes dirt, grime, scuff marks and oxidation stains.
- Safe for use on all rubber and vinyl surfaces.
- Leaves a tough protective coating.
- The quick and easy way to maintain inflatable boats and boat fenders.
- Protects against sun's harmful UV rays.
- Safe for all types of inflatables.

Order No.	Mfg. No.	Size	List Price
625395	(83416)	16 fl. oz.	\$15.19

Star Brite Rain View



- Improves wet weather visibility through windshield and windows.
- Use on glass.
- Works with or without windshield wipers.
- Makes surface so slick that rain and wet weather deposits literally slide off.

Order No.	Mfg. No.	Size	List Price
626549	(88708)	8 fl. oz.	\$12.29

- Electronics
- Trolling Motors
- Instruments
- Electrical
- Lighting
- Anchor & Dock
- Safety
- Steering, Controls
- Pumps
- Fuel System
- Seating & Pedestals
- Trailer
- Tops & Covers
- Perform.
- Propellers
- Engine & Care
- Cleaning & Care
- Paint & Paint Acc.
- Fun & Flotation
- Topside Acc.
- Cockpit & Deck
- Hardware, Fasteners
- Camouflage
- Misc.
- Comm.

Electronics

Trolling Motors

Instruments

Electrical

Lighting

Anchor & Dock

Safety

Steering, Controls

Pumps

Fuel System

Seating & Pedestals

Trailer

Tops & Covers

Perform.

Propellers

Engine & Care

Cleaning & Care

Paint & Paint Acc.

Fun & Flotation

Topside Acc.

Cockpit & Deck

Hardware, Fasteners

Camouflage

Misc.

Comm.

Star Brite Power Pine Bilge Cleaner



- Pine extract formula emulsifies oil, grease, fuel and transmission fluid.
- Concentrated formula makes 96 gallons (32 fl. oz. size) or 384 gallons (1 gallon size).
- Works in fresh or salt water.
- Environmentally safe, biodegradable.
- Leaves bilges smelling clean and fresh.

Order No.	Mfg. No.	Size	List Price
629850	(93832)	32 fl. oz.	\$17.59
GO-9711000			

Star Brite Instant Hull Cleaner - Gel Formula



- New gel formula "sticks" where applied for maximum cling time and cleaning power.
- Naturally powerful oxalic acid formula, more user-friendly than harsher hydrochloric or phosphoric acid formulas.
- Specifically formulated to remove the toughest stains, including rust, dried fish blood and leaf stains.
- Works on all fiberglass and painted surfaces; ideal for vertical surfaces.

Order No.	Mfg. No.	Size	List Price
625655	(096132)	32 fl. oz.	\$16.69
GO-8111000			

Star Brite Liquid Rubbing Compound - Medium Duty



- Liquid formula rubbing compound designed for light to medium duty applications.
- Removes stains, oxidation and scratches.
- For fiberglass, metal and painted surfaces.
- Convenient liquid formula.
- Does not set up like most rubbing compounds so removal is quick and easy.
- For light to medium duty applications.

Order No.	Mfg. No.	Size	List Price
624925	(81316)	16 fl. oz.	\$12.09
GO-0180000			

Star Brite Heavy Duty Bilge Cleaner



- Biodegradable.
- Easy to use; just pour in, run boat, pump out.
- Dissolves and eliminates oil, grease, gasoline, scum and sludge.

Order No.	Mfg. No.	Size	List Price
625686	(80532)	32 fl. oz.	\$12.29
629709	(080500N)	Gallon	\$31.09
GO-3280000			
GO-3802000			

Star Brite Instant Hull Cleaner



- Naturally powerful oxalic acid formula, more user-friendly than harsher hydrochloric or phosphoric acid formulas.
- Quickly removes stains from water line.
- Excellent for use on fiberglass, metal and painted surfaces.

Order No.	Mfg. No.	Size	List Price
625650	(81732)	32 fl. oz.	\$17.49
625648	(081700N)	Gallon	\$50.79
GO-2711000			
GO-3043000			

Star Brite Premium Restorer Wax



- Enhances shine while adding protection against stains and UV exposure.
- Ideal for use on colored fiberglass hulls.
- Removes medium and heavy oxidation.
- Can be applied by hand or with a buffer.

Order No.	Mfg. No.	Size	List Price
625030	(086016)	16 fl. oz.	\$16.09
GO-8701000			

Star Brite Boat Bottom Cleaner



- Removes deposits on boat bottoms, scum line and rust stains quickly and easily.
- Special patented buffering process makes this product safer than other acid based bottom cleaners.

Order No.	Mfg. No.	Size	List Price
625674	(92232)	32 fl. oz.	\$17.49
625662	(92200)	Gallon	\$47.69
GO-2711000			
GO-5913000			

Star Brite EZ-ON EZ-OFF Hull and Bottom Cleaner



- Removes deposits on boat bottoms, scum line and rust stains quickly and easily.
- Loosens the toughest deposits on boat bottoms, removes scum lines and rust stains.
- Water based, environmentally friendly formula.
- Special patented buffering process makes this product safer than other acid based bottom cleaners.

Order No.	Mfg. No.	Size	List Price
625665	(092832)	32 fl. oz.	\$12.19
625667	(092800)	Gallon	\$31.79
GO-7180000			
GO-0312000			

Star Brite Fiberglass Color Restorer with PTFE®



- Brings back original color and lustre.
- Removes oxidation, chalking and fading.
- Seals surface to protect against future fading and weathering.
- Will not scratch or harm gelcoat.
- Excellent for colored hulls.
- Application is simple, whether by hand or with a buffer; apply, let dry to a haze and wipe off.

Order No.	Mfg. No.	Size	List Price
624886	(81816)	16 fl. oz.	\$15.29
GO-4201000			



Star Brite Premium Cleaner Wax



- Cleans, shines and protects in one step.
- Removes oxidation and chalk while leaving a durable coat of special polymers.
- Specially formulated for fiberglass, metals and painted surfaces.
- UV inhibitors help prevent fading and oxidation.

Order No.	Mfg. No.	Size	List Price	
625220	(89616P)	16 fl. oz.	\$15.69	GO-1501000
625232	(89632)	32 fl. oz.	\$22.99	GO-0451000

Star Brite Presoftened Boat Wax



- Easy to use presoftened wax formula.
- Classic carnauba wax formula provides a deep, rich shine.
- Long lasting protection against fading, chalking, oxidation and UV rays.
- Use on fiberglass, aluminum, chrome and on painted surfaces.
- Shines and protects in one easy step.
- May be applied in direct sunlight.
- Easy apply by hand or with a buffer.

Order No.	Mfg. No.	Size	List Price	
625028	(82314)	14 oz.	\$15.29	GO-4201000

Star Brite Instant Black Streak Remover



- Quickly removes black streaks caused by water run off.
- Safe for use on fiberglass, metal and painted surfaces.
- Will not remove wax or polish.

Order No.	Mfg. No.	Size	List Price	
628151	(71622)	22 fl. oz.	\$11.39	GO-3670000
628148	(71600)	Gallon	\$36.39	GO-8342000

Star Brite Premium Marine Polish



- The ultimate protection for fiberglass, metal and painted surfaces.
- UV inhibitors help stop fading and oxidation.
- Leaves a super smooth, non-stick special coating which reduces drag and repels dirt, grime, oil and stains.

Order No.	Mfg. No.	Size	List Price	
625181	(85716)	16 fl. oz.	\$20.69	GO-6831000
625218	(85732)	32 fl. oz.	\$32.59	GO-4812000

Star Brite Clear Plastic Restorer



- Restores hazy or yellowed clear plastic enclosures.
- Removes fine scratches from acrylic, polycarbonate and most other types of plastic surfaces.
- Cleans off stains, salt deposits and surface discoloration.
- Use as the first step in the restoration of deteriorated plastic.
- Safe for use on Strataglass, EZ2CY, Eisinglass and all other clear plastic surfaces.

Order No.	Mfg. No.	Size	List Price	
625460	(087208)	8 fl. oz.	\$10.39	GO-6960000

Star Brite View Guard Clear Plastic Treatment



- Enhance wet weather visibility.
- Safe for use on Strataglass, EZ2CY, Eisinglass and all other clear plastic surfaces.
- Repels water, spray, salt and dirt.
- Gently cleans clear plastic surfaces.
- Provides protection against damaging UV rays.

Order No.	Mfg. No.	Size	List Price	
625448	(95222)	22 fl. oz.	\$13.69	GO-7190000

Star Brite Marine Polish



- Keeps your boat looking like new.
- Removes scratches, swirl marks, chalk and oxidation from fiberglass and painted surfaces.
- Helps stop fading caused by UV rays.
- No hard rubbing required.
- Can be applied by hand or with a buffer.
- Lasts up to 4 times longer than other polishes or waxes.
- Specially formulated for fiberglass and aluminum boats.

Order No.	Mfg. No.	Size	List Price	
625080	(80116)	16 fl. oz.	\$15.69	GO-1501000

Star Brite Clear Plastic Polish



- Restores shine and clarity to acrylic, polycarbonate and most other types of plastic surfaces.
- Adds UV protection to all clear plastic surfaces.
- Use as the second step in the restoration of deteriorated plastic.
- Safe for use on Strataglass, EZ2CY, Eisinglass and all other clear plastic surfaces.

Order No.	Mfg. No.	Size	List Price	
625458	(087308)	8 fl. oz.	\$10.39	GO-6960000

Star Brite Ultimate Xtreme Clean



- Special chelating agents break the bond that holds dirt or stains to surface without heavy scrubbing.
- Phosphate-free, safe for use on or near the water; runoff won't harm sea life or cause algae blooms.
- Cleans fiberglass, vinyl, plastic, metal and even inflatable boats.

Order No.	Mfg. No.	Size	List Price	
999138	(83222)	22 fl. oz.	\$10.59	GO-0170000

Electronics

Trolling Motors

Instruments

Electrical

Lighting

Anchor & Dock

Safety

Steering, Controls

Pumps

Fuel System

Seating & Pedestals

Trailer

Tops & Covers

Perform.

Propellers

Engine & Care

Cleaning & Care

Paint & Paint Acc.

Fun & Flotation

Topside Acc.

Cockpit & Deck

Hardware, Fasteners

Camouflage

Misc.

Comm.

Star Brite Ultimate Aluminum Cleaner/Restorer



- Formulated to clean and restore stained or dull aluminum pontoon boats, jon boats and canoes.
- Convenient 64 fl. oz. size with sprayer for easy application.

Order No.	Mfg. No.	Size	List Price
625387	(87764)	64 fl. oz.	\$24.69

Star Brite Ultimate Vinyl Clean



- Powerful formula is tough on dirt, won't harm vinyl.
- Contains no harsh acids or caustic cleaners.
- Engineered for use on vinyl, plastic, rubber and leather surfaces.

Order No.	Mfg. No.	Size	List Price
7001354	(96232)	32 fl. oz.	\$11.99

Star Brite Vinyl Brite Protectant



- Protects and moisturizes vinyl, rubber and plastic surfaces.
- Keeps new vinyl looking good; adds shine to old vinyl.
- Spray on, wipe up excess; ideal for car interiors and tires, too.
- UV inhibitors screen out sun's damaging rays.
- Helps prevent vinyl from cracking, fading and discoloring.

Order No.	Mfg. No.	Size	List Price
625434	(80316)	16 fl. oz.	\$15.39

Star Brite Chrome and Stainless Polish



- Cleans and shines all chrome and stainless steel surfaces.
- Protects against pitting, discoloration, staining and/or rusting.
- Easy to use. Wipe on, wipe off formula.
- Resists salt and water spray.
- Bonds to metal for long lasting protection.
- Leaves a dazzling shine.

Order No.	Mfg. No.	Size	List Price
625535	(82708)	8 fl. oz.	\$10.39

Star Brite Vinyl Cleaner & Shampoo



- Quickly removes dirt, stains and grease.
- Use on vinyl-coated canvas, chairs, cushions and foul weather gear.
- Gets out deeply embedded grime.
- Won't streak, stain or discolor vinyl.
- Excellent for all interior and exterior vinyl.
- Concentrated formula.
- Biodegradable.

Order No.	Mfg. No.	Size	List Price
625408	(80216)	16 fl. oz.	\$7.89

Star Brite Spider Away



- "Shoos" spiders away without harming them.
- Keeps messy spiders away from your boat.
- Safe for use around pets and children.
- Ideal for use around the house, garage and garden, too.

Order No.	Mfg. No.	Size	List Price
625585	(95022)	22 fl. oz.	\$12.99

Star Brite Ultimate Aluminum Protectant



- Cleans, shines and protects aluminum and stainless steel surfaces.
- Special polymers provide a protective barrier against damaging UV rays, salt corrosion and dirt.
- Polymers actually bond to surface for long-lasting protection.
- Ideal for use on towers, T-tops, railings, wakeboard towers and all other polished metal surfaces.

Order No.	Mfg. No. / Description	List Price
625750	(080922P) 22 fl. oz.	\$15.19

Star Brite Vinyl Cleaner & Polish



- A revolutionary formula that restores vinyl unlike any other vinyl polish, protectant or treatment.
- Formulated to deep clean vinyl to remove embedded grime; leaves a barrier against UV and dirt.
- Leaves a long lasting, waterproof protective coating.
- Keeps vinyl soft and supple, prevents drying out and cracking.
- UV protection shields against sun's harmful rays.

Order No.	Mfg. No.	Size	List Price
625446	(91016)	16 fl. oz.	\$14.09

Star Brite Bird and Spider Stain Remover



- Quickly dissolves messy spider and bird droppings.
- Non-toxic, all-natural formula.
- Contains no bleach; safe for use around kids and pets.
- Will not remove polish or wax.
- Safe for all marine surfaces and fabrics.

Order No.	Mfg. No.	Size	List Price
625597	(95122)	22 fl. oz.	\$12.49

Star Brite Slime & Grime Stain Remover



- Removes mold stains and mildew stains, rust, tarnish and other tough stains.
- Works on boat bottoms, shower stalls, floor tile, fiberglass, wood, aluminum, cement and non-skid decks.
- Concentrated powder formula.

Order No.	Mfg. No. / Description	List Price
625745	(094816) 16 oz.	\$21.29

Star Brite Premium Teak Cleaner - Step 1



- Cleans teak and other fine woods.
- Removes stains and weathering.
- Use as the first step in the restoration of grey, weathered teak.
- No need to sand after cleaning.
- Does not contain acid - no neutralizers needed.
- Does not raise wood grain.

Order No.	Mfg. No.	Size	List Price
626056	(81432)	32 fl. oz.	\$19.19
626068	(081400N)	Gallon	\$50.19

Star Brite One Step Teak Cleaner & Brightener



- Combines two steps in one; cleans and brightens.
- Saves time and effort preparing teak for oiling.
- Safe for use on all teak decks and furniture.
- Will not harm fiberglass or painted surfaces.
- Contains no dangerous acids.
- Cleans teak; removing dirt, grime and old oil.
- Phosphate-free, biodegradable formula.

Order No.	Mfg. No.	Size	List Price
625939	(094932)	32 fl. oz.	\$18.39

Star Brite Premium Teak Brightener - Step 2



- Brightens teak and other fine woods.
- Highlights wood grain and enhances warm natural color.
- Use as the second step in the restoration of grey weathered teak.
- Easy to use - just apply and rinse.
- No rubbing or scrubbing required.

Order No.	Mfg. No.	Size	List Price
626118	(081516)	16 fl. oz.	\$14.09
626119	(81532)	32 fl. oz.	\$19.19

Star Brite Teak Sealer - Classic Teak



- No drip, no splash formula.
- Replaces teak oils.
- Helps keep teak from turning black.
- Long-lasting, even in tropical sun and salt.
- Only one coat required for most applications.

Order No.	Mfg. No. / Description	List Price
625977	(088016) 16 fl. oz.	\$28.39
625989	(088032) 32 fl. oz.	\$41.39

Star Brite Premium Teak Care Kit



- Everything needed to clean, restore and protect teak in one convenient package.
- Each kit contains: (1) Teak Cleaner, (1) Teak Brightener and (1) Teak Oil.

Order No.	Mfg. No.	Size	List Price
625953	(81216)	16 fl. oz.	\$42.69
625965	(081202)	32 fl. oz.	\$59.69

Star Brite Premium Golden Teak Oil - Step 3



- Gives teak a natural warm golden color.
- Contains ultraviolet absorbers to resist weathering.
- Lasts 4 to 6 times longer than standard teak oils.
- Advanced tung oil polymer formula.

Order No.	Mfg. No.	Size	List Price
626210	(85116)	16 fl. oz.	\$18.99
626222	(85132)	32 fl. oz.	\$28.79
626234	(85100)	Gallon	\$83.39

Snappy Teak-Nu



- For that freshly sanded look.
- Clean and restore decking and furniture with this convenient and easy-to-use DIY kit.
- Contains both Snappy Teak-Nu Formula 1 (32 fl. oz.) and Formula 2 (32 fl. oz.), as well as two color-coded brushes for each.

Order No.	Mfg. No.	List Price
437308	(STN-QKIT)	\$32.49

FORMULA 1

Order No.	Mfg. No.	Size	List Price
437311	(STN-Q1)	32 fl. oz.	\$12.69
437335	(STN-G1)	Gallon	\$32.69

FORMULA 2

Order No.	Mfg. No.	Size	List Price
437323	(STN-Q2)	32 fl. oz.	\$12.69
437347	(STN-G2)	Gallon	\$32.69



SPECIAL HANDLING MAY APPLY



- Electronics
- Trolling Motors
- Instruments
- Electrical
- Lighting
- Anchor & Dock
- Safety
- Steering, Controls
- Pumps
- Fuel System
- Seating & Pedestals
- Trailer
- Tops & Covers
- Perform.
- Propellers
- Engine & Care
- Cleaning & Care
- Paint & Paint Acc.
- Fun & Flotation
- Topside Acc.
- Cockpit & Deck
- Hardware, Fasteners
- Camouflage
- Misc.
- Comm.

Star Brite NosGUARD SG Mildew Odor Control Bag - Fast Release



- Eliminates odors extremely quickly from enclosed areas up to 1,000 cubic feet.
- Ideal for use in stored boats, RVs, vacation homes and more.
- Removes mold/mildew odor as well as musty smells, food and smoke odor.
- Contains: (1) 10-gram pouch.

Order No. Mfg. No. / Description List Price
460912 (89970) **\$9.39** GO-9260000

Star Brite NosGUARD SG Mildew Odor Control Bags - Slow Release



- Maintains enclosed areas, keeping them odor-free.
- Treats areas up to 1,000 cubic feet.
- Ideal for preventing odor in stored boats, RVs, garages and vacation homes.
- Can be used year-round in boats, RVs and homes.
- Contains: (2) 10-gram pouches.

Order No. Mfg. No. / Description List Price
460901 (89950) **\$13.59** GO-1190000

Star Brite NosGUARD SG Mildew Odor Control Display - Slow Release



- NosGUARD SG Mildew Odor Control Display - Slow Release.
- Dimensions: 60" H x 16-1/4" W x 24" D.
- **Contains:**
 (32) 89950 - Twin Packs of NosGUARD SG Mildew Odor Control Bags - Slow Release
- Note: Not for sale in California.

Order No. Mfg. No. / Description List Price
460922 (89932) **\$431.59** GO-7198200

Star Brite NosGUARD SG Mildew Odor Control Bags - Slow Release



- Eliminates mildew odors and musty odors.
- Formaldehyde free.
- Each pouch protects 1,000 cubic feet.
- Lasts up to 4 months.

Order No. Mfg. No. / Description List Price
625540 (089924) 25 Pack - Bulk **\$151.59** GO-7510100
460891 (89910) 100 Pack - Bulk **\$568.59** GO-6908300

Star Brite No Damp® Hanging Moisture Absorber and Dehumidifier



- Absorbs airborne moisture to help prevent musty smells.
- Eliminates mildew odor and other musty odors.
- Protects boats in storage, vacation homes, basements and other enclosed areas.
- Features spillproof bag to safely hold collected moisture.

Order No. Mfg. No. / Description List Price
460883 (85470) 16 oz. **\$7.39** GO-5940000
460855 (085472) (25) 16 oz. Packs **\$104.49** GO-1007000

Star Brite No Damp® Dehumidifier Buckets



- Draws out moisture to prevent musty odors.
- Unique inner basket design increases efficiency and life of unit.
- 12 oz. size is ideal for protecting boat cabins, closets, small rooms or safes.
- 36 oz. size is perfect for salons, engine rooms, campers, basements, garages or other large areas.

Order No. Mfg. No. / Description List Price
460864 (85412) 12 oz., Treats 900 cu. ft. Area **\$7.99** GO-5350000
460852 (85401) 36 oz., Treats 1,800 cu. ft. Area **\$14.09** GO-4490000

Star Brite No Damp® Dehumidifier Refill



- Refills all No Damp Dehumidifiers.
- Add right on top of remaining chemical.
- Very economical to use.

Order No. Mfg. No. / Description List Price
460840 (85400) 12 oz. **\$3.19** GO-4120000
460842 (85448) 48 oz. (4) 12 oz. Refills **\$9.39** GO-9260000

- Electronics
- Trolling Motors
- Instruments
- Electrical
- Lighting
- Anchor & Dock
- Safety
- Steering, Controls
- Pumps
- Fuel System
- Seating & Pedestals
- Trailing
- Tops & Covers
- Perform.
- Propellers
- Engine & Care
- Cleaning & Care
- Paint & Paint Acc.
- Fun & Flotation
- Topside Acc.
- Cockpit & Deck
- Hardware, Fasteners
- Camouflage
- Misc.
- Comm.

Star Brite Rust Stain Remover



- Safe for use on fiberglass, metal and painted surfaces.
- Removes rust drip stains and sprinkler rust deposits.
- Contains no harsh acids.
- Great for cleaning corrosion stains caused by metal hardware, nuts, bolts and other marine fittings.

Order No.	Mfg. No.	Size	List Price	
625680	(89222)	22 fl. oz.	\$12.89	G0-4680000
625678	(89200)	Gallon	\$42.79	G0-7682000

Star Brite Rust Eater & Converter



- Chemically designed to remove rust and oxidation without harming the original metal.
- Converts rust to stable, solid form.
- Makes excellent base coat for painting metal.
- Biodegradable.
- Special buffering process makes this acid product safe to use.

Order No.	Mfg. No. / Description	List Price	
625676	(092322) 22 fl. oz.	\$14.09	G0-4490000

Star Brite Ultimate Magic Sponge



- The fastest way to remove stains, scuffs and streaks from fiberglass and vinyl surfaces.
- For home, auto, RV, boat and more.
- Instantly erases dirt, grime, scuff marks and streaks.
- Removes scuffs and stains from vinyl, plastic and fiberglass.
- Ideal for walls, appliances, baseboards, showers, tubs and tiles.

Order No.	Mfg. No.	Size	List Price	
675968	(041008)	XL - 8 Pack	\$5.99	G0-1040000
675970	(041018)	18 Pack	\$2.39	G0-0610000

Star Brite Mildew Stain Remover



- Removes mildew stains on contact.
- Simple spray on application.
- Use on headliners, vinyl covers, cushions, etc.
- Provides amazing results in minutes.
- Safe for all surfaces.
- Does not weaken fabric or thread.

Order No.	Mfg. No.	Size	List Price	
625559	(85616)	22 fl. oz.	\$11.49	G0-0770000
625548	(85600)	Gallon	\$49.99	G0-9433000

Star Brite Mildew Stain Blocker

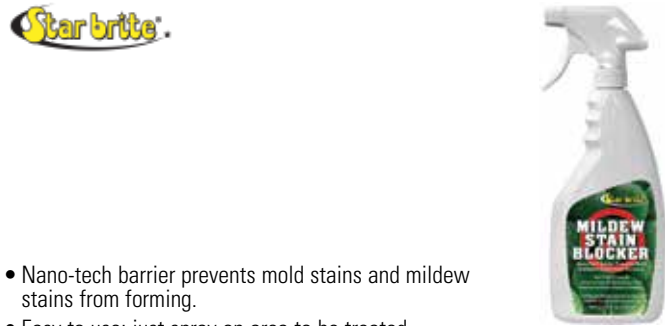

- Nano-tech barrier prevents mold stains and mildew stains from forming.
- Easy to use; just spray on area to be treated.
- Lasts up to 3 months (interior areas).
- Non-toxic formula; safe for use around people and pets.
- For use on fiberglass, vinyl, plastic, rubber, fabric and painted surfaces.

Order No.	Mfg. No.	Size	List Price	
625575	(86622)	22 fl. oz.	\$14.29	G0-7590000

Star Brite Tea Tree Air Purifier



- Genuine Australian tea tree oil.
- Eliminates musty odors naturally.
- Ideal for winterized boats and year-round use.
- Keeps air clean and fresh.
- For use anywhere on boat or RV.

Order No.	Mfg. No.	Size	List Price	
460930	(96504)	4 fl. oz. Tub	\$18.49	G0-9321000
460935	(96508)	8 fl. oz. Tub	\$28.99	G0-2491000
460940	(96516)	16 fl. oz. Spray	\$16.89	G0-2311000

Forespar Tea Tree Power® Mold & Odor Eliminator



- All natural made with 100% Australian Tea Tree Oil.
- Slowly evaporates to provide continuous, natural, and long-lasting odor control for up to 3 months.
- It penetrates deep into porous materials (cushions, carpets, and upholstery) delivering a deep cleaning with enduring odor protection.

Order No.	Mfg. No.	Size	List Price	
434773	(770202)	4 oz. Gel	\$29.39	G0-9691000

- Electronics
- Trolling Motors
- Instruments
- Electrical
- Lighting
- Anchor & Dock
- Safety
- Steering, Controls
- Pumps
- Fuel System
- Seating & Pedestals
- Trailer
- Tops & Covers
- Perform.
- Propellers
- Engine & Care
- Cleaning & Care
- Paint & Paint Acc.
- Fun & Flotation
- Topside Acc.
- Cockpit & Deck
- Hardware, Fasteners
- Camouflage
- Misc.
- Comm.

Electronics

Trolling Motors

Instruments

Electrical

Lighting

Anchor & Dock

Safety

Steering, Controls

Pumps

Fuel System

Seating & Pedestals

Trailer

Tops & Covers

Perform.

Propellers

Engine & Care

Cleaning & Care

Paint & Paint Acc.

Fun & Flotation

Topside Acc.

Cockpit & Deck

Hardware, Fasteners

Camouflage

Misc.

Comm.

3M Perfect-It™ Boat Wash



- Cleans from stern to stern without stripping wax.
- Cleans grime, algae, dirt and common marine contaminants.
- Professional strength concentrate makes up to one gallon per ounce.
- Important first step in cleaning and refinishing your surfaces.

Order No.	Mfg. No.	Size	List Price	
857396	(09034)	Pint	\$14.39	F0-7001000

3M Marine Color/Gloss Restorer



- Rubbing compound and finishing material in one step saves time and money.
- Easy to apply by hand or machine for any size job.
- Features aluminum oxide mineral for removing oxidation and scratches
- Leaves a high-gloss finish.
- Safe to use on fiberglass gelcoat surfaces – contains no wax or silicone.

Order No.	Mfg. No.	Size	List Price	
857260	(09089)	Pint	\$32.29	F0-0622000

3M Marine Rubbing Compound



- Suggested for heavy, aggressive compounding of oxidized gelcoat and marine paint.
- Clings to paint and gelcoated surfaces - remains wet on the job with little or no mess.
- Buffs to high gloss with minimum of swirl marks.
- Can be used by hand or machine.

Order No.	Mfg. No.	Size	List Price	
857175	(09004)	Pint	\$18.69	F0-8031000

3M Perfect-It™ Medium Cutting Compound + Wax



- One step compound and wax.
- Combines medium cutting power with a glossy finish and durable wax.
- Removes P1000 and finer scratches and protects the surface.
- Great for marine, RV, and industrial gelcoat surfaces.
- Stays wet longer so operators can use less, and see easier cleanup.

Order No.	Mfg. No.	Size	List Price	
856998	(36105)	Pint	\$25.39	F0-7771000
857000	(36106)	Quart	\$43.29	F0-0303000

3M Perfect-It™ Gelcoat Heavy Cutting Compound



- Cuts through heavy oxidation, scratches, and other defects fast.
- Removes P800 and finer scratches.
- Great for marine, RV, and industrial gelcoat surfaces.
- Stays wet longer so operators can use less and see easier cleanup.

Order No.	Mfg. No.	Size	List Price	
856991	(36101)	Pint	\$32.69	F0-8822000
856992	(36102)	Quart	\$59.79	F0-5814000
856994	(36103)	Gallon	\$196.79	F0-5773100

3M Perfect-It™ EX AC Rubbing Compound



- 3M's best-performing rubbing compound for removing P1200 or finer sand scratches.
- Formulated for a broad range of user conditions without sticking or leaving residual film.
- Works especially well on many newer, harder to buff clear coats.
- Holds better on compounding pads for reduced sling, mess and cleanup time.

Order No.	Mfg. No.	Size	List Price	
856964	(36060)	Quart	\$58.59	F0-1014000
856967	(36061)	Gallon	\$181.49	F0-4072100

3M Marine Compound and Finishing Material



- Removes light to heavy oxidation.
- Eliminates sand scratches and swirl marks.
- Unique formula combines compound and polish.
- Fast cutting action saves time.
- Delivers a high gloss finish.

Order No.	Mfg. No.	Size	List Price	
856899	(06044)	Quart	\$60.19	F0-3124000
856901	(06045)	Gallon	\$198.29	F0-0883100

3M Perfect-It™ Rubbing Compound



- 3M Perfect-It Rubbing Compound swiftly removes sand scratches and surface defects.
- 3M's best performing, fastest cutting compound also leaves the finest finish.
- Use with 3M Perfect-It Compounding Pads.

Order No.	Mfg. No.	Size	List Price	
856887	(06085)	Quart	\$64.39	F0-7054000

3M Marine Super Duty Rubbing Compound



- Economical liquid compound delivers a high rate of cut.
- Compound removes 1000 and finer sand scratches.
- Removes oxidation.
- Formula remains wet for a long time and continues to cut with medium pressure.
- Compound may be applied by hand or machine.

Order No.	Mfg. No.	Size	List Price	
856863	(05954)	Quart	\$32.89	F0-2032000
856875	(05955)	Gallon	\$107.29	F0-0157000

3M Marine Finesse-It™ II Glaze



- Glaze removes light oxidation.
- Eliminates minor scratches and compound swirl marks.
- Rejuvenates faded and neglected paint and gelcoat surfaces.
- Recommended for boats.
- Wax-free, silicone free formula.

Order No.	Mfg. No.	Size	List Price	
857176	(09048)	Pint	\$35.29	F0-0742000
856952	(35928)	Quart	\$65.99	F0-9164000

3M Marine Finesse-It™ Marine Paste Compound



- Formulated for boat reconditioning of heavily oxidized surfaces and finishes.
- Removes sand scratches on production gelcoat.
- White color reduces the potential of staining light-colored boats.
- Recommended step prior to polishing and waxing.



Order No.	Mfg. No.	Size	List Price
856926	(06039)	Gallon	\$69.99 F0-9984000

3M Marine High Gloss Gelcoat Compound



- Compound removes scratches caused by sanding.
- Formula effectively removes oxidation, stains and surface blemishes.
- Use of this product creates a high gloss shine.
- Product is wax and silicone free.
- Fast-cut formulation reduces compounding time.



Order No.	Mfg. No.	Size	List Price
856890	(06025)	Gallon	\$100.99 F0-9607000

3M Marine Perfect-It™ Boat Wax



- 3M's best wax solution to provide a brilliant gloss and durable protection from the elements.
- It is formulated polymer with carnauba for easy removal, and is safe for gelcoat, paint, fiberglass and metal.
- It also has a pleasant tropical scent.



Order No.	Mfg. No.	Size	List Price
857010	(36112)	Pint	\$20.29 F0-0241000
857012	(36113)	Quart	\$36.69 F0-8652000

3M Perfect-It™ Gelcoat Light Cutting Polish + Wax



- One step compound and wax.
- Combines light cutting power with a glossy finish and durable wax.
- Removes P1500 and finer scratches and protects the surface.
- Great for marine, RV, and industrial gelcoat surfaces.
- Stays wet longer so operators can use less, and see easier cleanup.



Order No.	Mfg. No.	Size	List Price
857004	(36109)	Pint	\$22.49 F0-4751000
857006	(36110)	Quart	\$38.09 F0-6662000

3M Marine Cleaner and Wax



- Removes light to medium oxidation.
- Cleans and polishes to restore shine and color.
- Unique formula combines compound and waxes.
- Helps protect against the effects of U.V. exposure.



Order No.	Mfg. No.	Size	List Price
857233	(09009)	Pint	\$22.19 F0-3551000
857245	(09010)	Quart	\$33.89 F0-2732000
857257	(09011)	Gallon	\$101.99 F0-9317000

3M Marine Scotchgard™ Marine Liquid Wax



- Uses reactive chemistry to bond to your boat's surface for added durability.
- Formula protects against weathering that can fade and degrade surfaces.
- Liquid wax is easy to apply.
- Safe for use on gelcoat, fiberglass and topside paints.



Order No.	Mfg. No.	Size	List Price
857375	(09061)	Pint	\$21.79 F0-5251000
857376	(09062)	Liter	\$39.49 F0-4672000

3M Marine Restorer and Wax



- Removes heavy oxidation.
- Polishes to restore shine and color.
- Unique formula combines rubbing compound and wax.
- Recommended for boats and RVs.



Order No.	Mfg. No.	Size	List Price
857168	(09005)	Pint	\$23.39 F0-7361000
857182	(09006)	Quart	\$40.09 F0-6082000
857194	(09007)	Gallon	\$114.99 F0-9408000

3M Marine Clean and Shine Wax



- Quick and easy, spray on/wipe off product that recaptures that just waxed look and feel.
- Excellent for use on wet or dry surfaces; no water needed!
- Enhances the shine of your boat's fiberglass gelcoat, marine topside paint, painted aluminum.



Order No.	Mfg. No.	Size	List Price
857373	(09033)	Pint	\$17.29 F0-0121000

3M Marine Perfect-It™ EX Ultrafine Machine Polish



- Produces a swirl free finish even on black vehicles.
- Outstanding finish.
- The unique formula eliminates swirl marks and produces a high gloss finish, even on the most difficult dark colored vehicles.
- Good handling, easy cleanup.



Order No.	Mfg. No.	Size	List Price
856935	(06068)	Quart	\$67.99 F0-9574000

- Electronics
- Trolling Motors
- Instruments
- Electrical
- Lighting
- Anchor & Dock
- Safety
- Steering, Controls
- Pumps
- Fuel System
- Seating & Pedestals
- Trailer
- Tops & Covers
- Perform.
- Propellers
- Engine & Care
- Cleaning & Care
- Paint & Paint Acc.
- Fun & Flotation
- Topside Acc.
- Cockpit & Deck
- Hardware, Fasteners
- Camouflage
- Misc.
- Comm.

3M Science.
Applied to Life.™

The Path to a Perfect Finish

Introducing our most advanced
gelcoat system, specifically
formulated for a more brilliant finish.



3M and Perfect-It are trademarks of 3M Company. © 3M 2016. All rights reserved.

www.repuestoselnavegante.com

El Navegante

3M™ Perfect-It™ Gelcoat Heavy Cutting Compound

This fast-cutting compound removes heavy oxidation, scratches, and other defects. Use 3M™ Perfect-It™ Gelcoat Heavy Cutting Compound for any P800 and finer scratches. Its improved formula has longer wet times for easier clean up and less dust. Plus, this formula works better in warm climates and allows you to use less material than before.

3M™ Perfect-It™ Gelcoat Heavy Cutting Compound works great on boats, RVs, and industrial gelcoats. While ideal for three-step processes, its high gloss results can be protected with 3M™ Perfect-It™ Boat Wax after compounding for an easy two-step finish.

Available in pint (16 fl oz), quart (32 fl oz), gallon (122 fl oz) and 5 gallon (640 fl oz) size.



3M™ Perfect-It™ Gelcoat Medium Cutting Compound + Wax (One-Step)

3M™ Perfect-It™ Gelcoat Medium Cutting Compound + Wax combines fast cutting power, a high gloss finish, and durable wax protection. Use this for any P1000 and finer scratches. Its improved formula has longer wet times for easier clean up and less dust, even in warm climates.

3M™ Perfect-It™ Gelcoat Medium Cutting Compound + Wax works great on boats, RVs, and industrial gelcoats. This one-step solution results in a brilliant finish and long-lasting protection for any of your gelcoat surfaces.

Available in pint (16 fl oz), quart (32 fl oz) and gallon (122 fl oz) size.



3M™ Perfect-It™ Gelcoat Light Cutting Polish + Wax (One-Step)

When a brilliant finish and durable protection are needed for P1500 and finer scratches, 3M™ Perfect-It™ Gelcoat Light Cutting Polish + Wax is the perfect solution for light or dark colored gelcoat. We've improved the formula with longer wet times offering easier clean up, less dust, and more efficient use, even in warm climates.

Specifically formulated for boats, RVs, and industrial gelcoats, this polish is ideal for one-step processes. Use whenever you want a durable wax finish.

Available in pint (16 fl oz), quart (32 fl oz) and gallon (122 fl oz) size.



3M Marine Vinyl Conditioner and Restorer



- Cleans, shines, conditions and protects vinyl, rubber and plastic surface.
- Deep cleans dirt and grime, enhances appearance.
- Restores natural sheen, protects surfaces.
- Fresh lemon scent.

Order No.	Mfg. No.	Size	List Price
857296	(16904)	Pint	\$16.49

3M Marine Vinyl Cleaner, Conditioner & Protector



- Gives vinyl a protective treatment.
- Cleans vinyl to keep it looking new.
- Restores natural sheen.
- Formulated for tough marine conditions.
- Easy-to-apply formula for use on vinyl and leather.

Order No.	Mfg. No.	Size	List Price
857295	(09023)	8.4 fl. oz.	\$19.19

3M Sharpshooter™ No-Rinse Mark Remover



- Removes stubborn marks, spots, and stains from almost any washable surface.
- Ready-to-use formulation.

Order No.	Mfg. No.	Size	List Price
7001548	(16861)	Quart	\$11.49

3M Marine Aluminum Restorer and Polish



- Restores the beauty and luster to aluminum.
- Removes heavy oxidation and chalking.
- Turns back the clock on the effects of weathering on aluminum.
- Concentrated formula provides a lot of cleaning with a small amount.
- May be applied by hand or machine.

Order No.	Mfg. No.	Size	List Price
857269	(09020)	18 oz.	\$33.89

3M Marine Metal Restorer and Polish



- Metal restorer removes rust and corrosion.
- Formula reverses the effects of oxidation.
- Polish brings out a lustrous shine.
- Recommended for stainless steel, brass, bronze, copper, chrome and aluminum.
- Paste consistency works smoothly over metal.

Order No.	Mfg. No.	Size	List Price
857284	(09019)	18 oz.	\$32.29

3M Marine Mildew Stain Remover



- Cleans unsightly mildew and mold growth.
- Restores surfaces so they look fresh and new.
- Penetrates to thoroughly eliminate mildew.
- Works on most marine surfaces throughout a boat.
- Spray-on formula is quick and easy to apply.

Order No.	Mfg. No.	Size	List Price
857159	(09067)	Pint	\$15.49

3M Marine Mildew Block



- Offers a unique solution in preventing unsightly mildew growth.
- Safe to use on most marine surfaces and materials above the waterline, and can be used both indoors and outdoors.
- Non-toxic formula helps keep surfaces looking newer and cleaner longer.

Order No.	Mfg. No.	Size	List Price
857156	(09065)	Pint	\$19.69

- Electronics
- Trolling Motors
- Instruments
- Electrical
- Lighting
- Anchor & Dock
- Safety
- Steering, Controls
- Pumps
- Fuel System
- Seating & Pedestals
- Trailer
- Tops & Covers
- Perform.
- Propellers
- Engine & Care
- Paint & Paint Acc.
- Fun & Flotation
- Topside Acc.
- Cockpit & Deck
- Hardware, Fasteners
- Camouflage
- Misc.
- Comm.

Marpro Boat Wash



- Powerful - 6 cap fulls clean a 24' boat.
- Special cleaning agents remove tar, gas stains, exhaust smudge, scum line, fish blood.
- Concentrated formula is economical to use.
- Cleans the entire boat from trailer to T-Top.

Order No.	Size	List Price	
7-1092	32 fl. oz.	\$6.19	F0-3340000
7-1093	Gallon 4 Per Case	\$14.29	F0-0001000

Marpro Liquid Rubbing Compound and Color Restorer



- Bring back original color and luster.
- Quickly removes oxidation and hazing.
- Great for fiberglass and painted surfaces.
- Priced each, sold packs of 4 only.

Order No.	Size	List Price	
7-2740	16 fl. oz.	\$8.49	F0-4950000

Marpro Deck Cleaner



- Quickly and easily removes dirt, grime, fish blood and more from non-skid surfaces.
- Safe for use on all fiberglass, vinyl, metal and painted surfaces.

Order No.	Size	List Price	
7-1094	32 fl. oz.	\$5.89	F0-2140000
7-1095	Gallon 4 Per Case	\$14.89	F0-2401000

Marpro Formula 9



- All purpose heavy duty cleaner and degreaser.
- Does not leave dulling film.
- Simple spray on, wipe off application.
- Whisks away oil grease, grime, dirt and stains.

Order No.	Size	List Price	
7-1091	22 fl. oz. 12 Per Case	\$5.39	F0-7730000
7-1090	Gallon 4 Per Case	\$18.89	F0-2231000

Marpro Premium Wash and Wax



- Cleans and waxes in one step.
- Biodegradable formula contains no phosphates or harsh chemicals.
- Strips away dirt but will not remove wax or polish.
- Leaves a durable polymer coating to protect against UV damage and weathering.
- Sold packs of 4 only.

Order No.	Size	List Price	
7-2732	32 fl. oz.	\$13.19	F0-3290000

Marpro Spray Fast Wax



- Spray on, wipe off for a fast deep shine.
- Ideal for fiberglass, painted surfaces, chrome and stainless steel.
- Easy to use spray-on formula.
- Priced each, sold packs of 4 only.

Order No.	Size	List Price	
7-2738	16 fl. oz.	\$15.69	F0-8901000

Marpro Plastic Cleaner and Restorer



- Safe for use on Isinglass, Strataglass, Plexiglass, plastic and vinyl.
- Removes hazing, restores clarity.
- Removes salt spray, grime, fingerprints and more from all types of clear plastic surfaces.
- Sold packs of 4 only.

Order No.	Size	List Price	
7-2720	22 fl. oz.	\$5.89	F0-2140000

- Electronics
- Trolling Motors
- Instruments
- Electrical
- Lighting
- Anchor & Dock
- Safety
- Steering, Controls
- Pumps
- Fuel System
- Seating & Pedestals
- Trailering
- Tops & Covers
- Perform.
- Propellers
- Engine & Care
- Cleaning & Care
- Paint & Paint Acc.
- Fun & Flotation
- Topside Acc.
- Cockpit & Deck
- Hardware, Fasteners
- Camouflage
- Misc.
- Comm.

Marpro Black Streak/Fish Blood Remover



- Removes black streak.
- Removes fish blood deposits.
- Safe for use on fiberglass, metal and painted surfaces.

Order No.	Size	List Price
7-1084	Gallon	\$17.29 FO-0121000

Marpro Bilge Cleaner



- Removes sludge, grime and odors to clean and freshen bilge.
- Heavy duty cleaning power.
- Easy to use; pour into bilge and run boat - motion "scrubs" bilge.
- Biodegradable formula won't harm hoses or bilge pumps.

Order No.	Size	List Price
7-1098	32 fl. oz.	\$6.99 FO-9840000
7-1099	Gallon 4 Per Case	\$15.39 FO-7701000

Marpro Hull Cleaner



- Quickly removes scum line and other tough stains.
- Specifically formulated for fiberglass and painted surfaces.
- Great way to prepare a hull for polishing.
- Buffered formula is very effective, but safe to use.

Order No.	Size	List Price
7-1096	32 fl. oz.	\$9.59 FO-1760000
7-1097	Gallon 4 Per Case	\$26.39 FO-7481000

Marpro EZ On EZ Off Hull and Bottom Cleaner



- Removes the toughest deposits and stains.
- The most effective hull & bottom cleaner available.
- Special high-tech, buffered hydrochloric acid makes it safer to use than traditional bottom cleaners.
- Ideal for cleaning RIB bottoms, too.
- Can be shipped UPS Air.

Order No.	Size	List Price
7-1089	32 fl. oz. 12 Per Case	\$9.19 FO-3460000
7-1088	Gallon 4 Per Case	\$22.39 FO-7651000

Marpro Salt Terminator



- Dissolves salt and leaves protective sheen.
- Protects against future corrosion.
- Mixer automatically dilutes concentrate and syphons it through standard garden hose.
- Good on all surfaces exposed to saltwater or air.

Order No.	Size	List Price
7-1340	12 fl. oz.	\$10.19 FO-3170000
7-1031	32 fl. oz.	\$17.09 FO-6911000
7-1033	32 fl. oz. Kit w/Nozzle	\$29.19 FO-3402000
7-1032	Gallon	\$37.09 FO-6952000

- Electronics
- Trolling Motors
- Instruments
- Electrical
- Lighting
- Anchor & Dock
- Safety
- Steering, Controls
- Pumps
- Fuel System
- Seating & Pedestals
- Trailering
- Tops & Covers
- Perform.
- Propellers
- Engine & Care
- Paint & Paint Acc.
- Fun & Flotation
- Topside Acc.
- Cockpit & Deck
- Hardware, Fasteners
- Camouflage
- Misc.
- Comm.

Meguiar's Flagship Premium Marine Wax Paste



- Easy to use formula offers long-lasting polymer protection and incredible deep gloss to fiberglass and gel coat surfaces.
- Protects against UV damage and wear.
- Removes light oxidation, fine scratches and swirls while providing long-lasting protection.
- Dramatically enriches color and shine while bringing out the full richness of the surface.
- Easy to apply and easy to wipe off.
- Formulated for use by hand.

Order No.	Mfg. No.	Size	List Price
628387	(M6311)	11 oz.	\$25.09

Meguiar's Flagship Premium Marine Wax



- Easy to use formula offers long-lasting polymer protection and incredible deep gloss to fiberglass and gel coat surfaces.
- Dramatically enriches color and shine of fiberglass and gel coat surfaces.
- Effective in removing light oxidation and dullness, restoring gloss and adding protection from UV damage.

Order No.	Mfg. No.	Size	List Price
628454	(M6316)	16 fl. oz.	\$20.19
628456	(M6332)	32 fl. oz.	\$31.69
628385	(M6301)	Gallon	\$72.99

Meguiar's Flagship Premium Wash N Wax



- Uses a exclusive blend of carnauba and synthetic polymers to add a valuable layer of wax protection while at the same time delivering great cleaning results.
- This advanced blend not only emulsifies salt spray, dirt, bird droppings and boat scum but also protects against salt air corrosion and the sun's ultraviolet rays while adding a brilliant streak free shine.

Order No.	Mfg. No.	Size	List Price
628520	(M4232)	32 fl. oz.	\$20.29

Meguiar's Flagship Premium Cleaner/Wax



- Formulated to effortlessly remove light to moderate below surface defects like oxidation, water spots, minor scratches, swirls, haze and more.
- Adds a brilliant gloss, amazing shine, and provides long-lasting, superior protection against salt air corrosion and the sun's devastating ultraviolet rays.
- Safe and effective on fiberglass, painted, and gel coat surfaces of any color, and can be used in direct sunlight.

Order No.	Mfg. No.	Size	List Price
628382	(M6132)	32 fl. oz.	\$25.29

Meguiar's Flagship Ultimate Detailer™



- Designed to quickly remove dirt, grime, water spots and other fresh contaminants while adding deep gloss and long-lasting polymer protection.
- Use on all surfaces of your boat, including gel coat, metal and clear plastics to create a just-washed appearance.
- Helps to repel water.

Order No.	Mfg. No.	Size	List Price
628535	(M9424)	24 fl. oz.	\$12.39

Meguiar's Boat Wash



- Safely removes grime and dirt without stripping wax protection.
- Biodegradable, economy size wash produces long lasting suds with a refreshing scent.

Order No.	Mfg. No.	Size	List Price
6270021	(M4364)	64 fl. oz.	\$11.39

Meguiar's Gel Wash



- Rich, biodegradable wash formula gently lifts boat scum, dirt, salt spray, grime, bird droppings and other loose contaminants without stripping wax protection.
- Sheeting action greatly reduces drying time.
- **628517**: Priced each, sold in case of 6 only.

Order No.	Mfg. No.	Size	List Price
628517	(M5416)	16 fl. oz.	\$6.69
6270031	(M5401)	Gallon	\$28.19

Meguiar's Marine/RV Fiberglass Restoration System



- A specialized three-step system to quickly and easily remove moderate defects, boost gloss, and add long-lasting protection to gel coat and fiberglass surfaces.
- Includes: M49 Heavy Duty Oxidation Remover safely removes moderate oxidation and defects while enhancing gloss and shine. M45 High Gloss Polish contains rich polishing oils to create a brilliant high gloss and maximum shine. M56 Pure Wax maintains an extraordinary gloss while adding durable long-lasting protection.

Order No.	Mfg. No. / Description	List Price
628379	(M4965)	\$39.59

- Electronics
- Trolling Motors
- Instruments
- Electrical
- Lighting
- Anchor & Dock
- Safety
- Steering, Controls
- Pumps
- Fuel System
- Seating & Pedestals
- Trailer
- Tops & Covers
- Perform.
- Propellers
- Engine & Care
- Cleaning & Care
- Paint & Paint Acc.
- Fun & Flotation
- Topside Acc.
- Cockpit & Deck
- Hardware, Fasteners
- Camouflage
- Misc.
- Comm.

- Electronics
- Trolling Motors
- Instruments
- Electrical
- Lighting
- Anchor & Dock
- Safety
- Steering, Controls
- Pumps
- Fuel System
- Seating & Pedestals
- Trailering
- Tops & Covers
- Perform.
- Propellers
- Engine & Care
- Cleaning & Care
- Paint & Paint Acc.
- Fun & Flotation
- Topside Acc.
- Cockpit & Deck
- Hardware, Fasteners
- Camouflage
- Misc.
- Comm.

Meguiar's Boat/RV Rinse Free Wash-N-Wax



- Quick and easy spray-on, wipe-off formula.
- Safe and effective on boats, RV's, Pontoons and PWC's (Personal Water Craft).
- Easy to use on wet or dry surfaces.
- Provides a high gloss and water beading durability.
- Safe to use on gelcoat, clear coat, fiberglass, glass, plastics, instrument panels and polished metals.

Order No.	Mfg. No.	Size	List Price
6285605	(M14332)	32 fl. oz.	\$13.49

Meguiar's Marine/RV Heavy Duty Oxidation Remover



- Safely removes moderate oxidation, waterspots, stains and scratches from gel coat and fiberglass surfaces.
- Formulated with enriched feeder oils to restore color while adding and enhancing brilliant shine and gloss.
- Restores the original color of older fiberglass gel coat surfaces by effectively removing surface degradation.
- Unique diminishing abrasives break down and safely disappear during application leaving the surface with a brilliant look and shine.

Order No.	Mfg. No.	Size	List Price
628377	(M4916)	16 fl. oz.	\$12.29

Meguiar's Heavy Oxidation Scrub



- Crucial first step during oxidation removal process to help save time.
- Quickly removes heavy oxidation, staining, rust and mold from gel coat, fiberglass and non-skid surfaces.
- After use, reduces chalky build-up in buffing pads, saving time and frustration, while delivering superior results.
- Water-soluble formulation with biodegradable detergents rinses easily with water.

Order No.	Mfg. No.	Size	List Price
6285251	(M77132)	32 fl. oz.	\$24.79

Meguiar's Marine/RV One Step Compound



- Formula is specifically designed to both clean the gel coat surfaces and leave behind a high gloss finish in one step.
- Removes heavy oxidation, scratches, stains and tough hard water spots on all fiberglass gel coat surfaces.
- Restores neglected surfaces while producing an amazing shine and luster.
- Restores the color leaving behind a rich, high gloss.

Order No.	Mfg. No.	Size	List Price
628381	(M6732)	32 fl. oz.	\$25.89

Meguiar's Marine/RV Color Restorer



- Safely removes light oxidation, stains and blemishes from fiberglass gel coat surfaces.
- Revives color and enhances gloss to reveal original vibrant appearance.
- Diminishing abrasives and mild cleaning agents work gently to revive and restore gel coats and fiberglass to their original luster.
- Formulated specifically for removing light defects from all gel coat and fiberglass surfaces.

Order No.	Mfg. No.	Size	List Price
628353	(M4416)	16 fl. oz.	\$11.69

Meguiar's Hard Water Spot Remover



- Specifically formulated to quickly and safely remove toughest hard water spots.
- Thick, low drip spray formula remains on vertical surfaces for easy cleaning.
- Formulated to chemically break down and remove hard water minerals off the surface.
- Helps protect from future water spots.
- Easy to apply and easy to wipe off.

Order No.	Mfg. No.	Size	List Price
628370	(M4716)	16 fl. oz.	\$12.59

Meguiar's Marine/RV One Step Cleaner Wax



- Non-abrasive formula quickly cleans, polishes, and protects all fiberglass gel coat marine or RV surfaces in one easy step.
- Safely and effectively removes light oxidation, haze, minor scratches and swirls.
- Provides durable long-lasting protection against salt air, corrosion and the sun's ultraviolet rays.

Order No.	Mfg. No.	Size	List Price
628404	(M5016)	16 fl. oz.	\$14.59
628428	(M5032)	32 fl. oz.	\$21.69
628391	(M5001)	Gallon	\$62.39

Meguiar's Marine/RV Pure Wax - Carnauba Blend



- Blends pure Brazilian Carnauba Wax with polymers and resins to provide enhanced gloss and long-lasting protection.
- Maintains extraordinary gloss while adding durable long-lasting protection.
- Safe, effective, and easy to use on all fiberglass, gel coat and painted surfaces.
- Especially effective on dark colors and clear-coated metal flake finishes.

Order No. Mfg. No. Size List Price
628430 (M5616) 16 fl. oz. **\$13.79** F0-5690000

Meguiar's Marine/RV Quik Wax® Clean & Protect



- Convenient and easy to use spray allows you to wax your boat or RV quickly, just mist-on and wipe-off.
- Cleans and creates deep gloss while preserving wax protection.
- Safe and effective on fiberglass, gel coats, painted surfaces (painted aluminum), stainless steel, clean plastic and other non-porous surfaces.
- Gently cleans the surface, removing water spots and light contaminants, while adding deep gloss and Carnauba wax protection.

Order No. Mfg. No. Size List Price
628442 (M5916) 16 fl. oz. **\$9.39** F0-7560000

Meguiar's Mirror Glaze® Heavy Duty Vinyl Cleaner



- Great for cleaning and prepping all vinyl, plastic, rubber and urethane surfaces.
- Safe and effective for vinyl tops, non-painted bumpers, plastic door panels, luggage, furniture and more.
- Cleans compound and polish residue from plastic moldings.
- Cleans and prepares vinyl, rubber, and plastics for a protectant leaving behind no greasy residue.
- Priced each, sold in case of 6 only.

Order No. Mfg. No. Size List Price
628478 (M3916) 16 fl. oz. **\$10.59** F0-1470000

Meguiar's Mirror Glaze® Clear Plastic Polish

- Safely restores optic clarity to all clear plastics.
- Provides a static-free coating that repels dust.

Order No. Mfg. No. Size List Price
628531 (M1008) 8 fl. oz. **\$8.89** F0-2260000

Meguiar's Marine/RV High Gloss Polish



- Contains rich polishing oils to feed and nourish gel coat and fiberglass surface.
- Formulated to restore optimal gloss on gel coat and fiberglass surfaces after cleaning and before applying a wax or sealant.
- Creates a brilliant, high gloss finish by restoring valuable oils that nourish the gel coat of boats and RV's.
- Especially effective on dark colors.

Order No. Mfg. No. Size List Price
628365 (M4516) 16 fl. oz. **\$11.49** F0-4080000

Meguiar's Marine/RV Vinyl & Rubber Cleaner



- A premium and complex blend of ingredients offers a safe deep cleaning ability, shine and protection to vinyl, rubber and plastic surfaces.
- Leaves vinyl, rubber, and plastics with a clean, rich, natural sheen instead of a greasy or artificial plastic look.
- Conditioners help prevent surfaces from drying, fading and cracking while UV protection reduces damaged caused by the sun.

Order No. Mfg. No. Size List Price
628480 (M5716) 16 fl. oz. **\$12.49** F0-4780000

Meguiar's Mirror Glaze® Clear Plastic Cleaner



- Removes fine hairline scratches from all types of clear plastic.
- Unique, non-abrasive formula Prepares surface for Meguiar's M10 Mirror Glaze Clear Plastic Polish - M1008.
- Perfect cleaner for computer screens, convertible windows, helmet visors, motorcycle windscreens, displays and instrument panels.

Order No. Mfg. No. Size List Price
628543 (M1708) 8 fl. oz. **\$8.89** F0-2260000

- Electronics
- Trolling Motors
- Instruments
- Electrical
- Lighting
- Anchor & Dock
- Safety
- Steering, Controls
- Pumps
- Fuel System
- Seating & Pedestals
- Trailering
- Tops & Covers
- Perform.
- Propellers
- Engine & Care
- Cleaning & Care
- Paint & Paint Acc.
- Fun & Flotation
- Topside Acc.
- Cockpit & Deck
- Hardware, Fasteners
- Camouflage
- Misc.
- Comm.

Marykate Spray Away™ All Purpose Cleaner



- Cleans grease, grime, oil, rain stains, fish blood and more.
- Great on virtually any surface.
- Heavy duty formula is four times stronger than most spray cleaning products.
- Non-flammable.

Order No.	Mfg. No.	Size	List Price
216540	(MK2832)	Quart	\$14.89 GO-8990000
216552	(MK28128)	Gallon	\$39.49 GO-6462000

Marykate Trewax® Boat Paste Wax



- Contains Carnauba.
- Leaves a hard, long-lasting, brilliant finish.
- Designed specifically for marine finishes.
- Use on fiberglass, painted surfaces, aluminum, chrome and stainless steel.

Order No.	Mfg. No.	Size	List Price
216716	(MK66)	12 oz.	\$26.39 GO-8671000

Marykate Ultra Vinyl Cleaner



- Removes deeply embedded dirt, grease, grime and oil.
- Easy to use.
- Concentrated foam cleaner works fast.
- Excellent for all interior and exterior vinyl.

Order No.	Mfg. No.	Size	List Price
216600	(MK2718)	18 oz.	\$12.89 GO-4680000

Marykate Pontoon and Aluminum Hull Cleaner



- Maximum strength formula quickly removes the heaviest oxidation and eliminates waterline stains, lime deposits and algae stains.
- Not for use on painted surfaces.

Order No.	Mfg. No.	Size	List Price
2899053	(MK3132)	Quart	\$18.99 GO-2721000
216588	(MK31128)	Gallon	\$43.39 GO-7092000

Marykate Super Suds™ Boat Soap



- Highly concentrated synthetic detergent.
- Non-streaking.
- Leaves no residue.
- Cleans away dirt and grime, leaving surfaces sparkling clean.
- Will not remove wax.

Order No.	Mfg. No.	Size	List Price
216463	(MK2232)	Quart	\$15.69 GO-1501000
216475	(MK22128)	Gallon	\$49.39 GO-9033000

Marykate Cleaning Detail® Non-Skid Deck Cleaner



- Cleans and brightens fiberglass, stainless steel, chrome, aluminum and brass.
- Removes dirt, grease, grime and chalking.
- Easy to use on most surfaces above the waterline.
- Great for non-skid decks, shower stalls and tubs.

Order No.	Mfg. No.	Size	List Price
216451	(MK2132)	Quart	\$19.79 GO-6231000

Marykate Nano Color Restorer with PTFE®



- Restores gelcoat to a like new gloss and shine.
- Removes oxidation, stains, and sun fading that can leave fiberglass looking dull.
- PTFE adds superior UV protection and excellent abrasion resistance.

Order No.	Mfg. No.	Size	List Price
216422	(MK7616)	Pint	\$12.79 GO-7580000

Marykate On & Off Hull and Bottom Cleaner



- Works instantly to remove the toughest waterline stains, algae stains, rust and gas exhaust stains.
- Use on fiberglass only. Will not harm gel coat.
- Gallons sold case of 4 only and not UPSable.

Order No.	Mfg. No.	Size	List Price
216425	(MK2032)	Quart	\$17.19 GO-2511000
216437	(MK20128)	Gallon	\$44.29 GO-7692000
2899058	(MK20550)	55 Gallon Drum	\$2,019.09 GO-9725310

SPECIAL HANDLING MAY APPLY



Marykate Black Streak Remover



- Quick, easy & effective.
- Instantly removes black streaks caused by water run off on fiberglass and metal.
- No scrubbing necessary.
- Spray on/wipe off.
- Commercial grade.
- Test on painted surfaces.

Order No.	Mfg. No.	Size	List Price
216728	(MK6732)	Quart	\$15.59

Marykate Big Bully® Natural Orange Bilge Cleaner



- Works instantly to emulsify oil, grease and scum.
- Tough citrus cleaning power absorbs odors and leaves bilge areas clean and fresh.
- Self-cleaning formula is activated by the rolling action of the boat.

Order No.	Mfg. No.	Size	List Price
216487	(MK2332)	Quart	\$17.19

Marykate On & Off Gel Hull and Bottom Cleaner



- Unique viscous formula clings to the surface to break down tough grease & oil and remove stubborn scum line and rust stains.
- Bold, blue-green color makes it easy to see where the product has been applied.

Order No.	Mfg. No.	Size	List Price
2899056	(MK3532)	Quart	\$18.59
216590	(MK35128)	Gallon	\$57.59

Marykate Aluminex™ Clean and Shine



- Dual-action formula specially designed to instantly clean and brighten aluminum hulls.
- With Safe Acid Technology best for light to medium oxidation.
- Safe on anodized and painted aluminum.

Order No.	Mfg. No.	Size	List Price
2899054	(MK3332)	Quart	\$21.49

Marykate Mildew Stain Remover



- Fast and effective.
- Fine mist spray won't run, even on vertical surfaces.
- No scrubbing necessary.
- Just spray on, wipe off.
- Use on any vinyl or hard surface.

Order No.	Mfg. No.	Size	List Price
216603	(MK3732)	Quart	\$15.99

Marykate Moisture Absorber



- Dries air in cabins, lockers, closets, bathrooms, basements and other enclosed areas.
- Concentrated pellet formula absorbs up to 50% more moisture than flake formulas.

Order No.	Mfg. No.	Size	List Price
2899063	(MK6912)	12 oz. Tub	\$8.29

CRC Empty Trigger Bottle



- 24 oz. bottle features volume measurements as well as blank lines and boxes where the user can add their own product and safety information.

Order No.	Mfg. No.	Size	List Price
290522	(14021)	24 oz.	\$7.19

CRC Visiclear Display & Electronics Screen Cleaner



- An unique, high quality, natural water based foam cleaner for all televisions, monitors, notebooks/laptops, camcorders, navigation systems, touch screens, PDSs, scanners and copy machines.
- It clings to surfaces and will not drip from vertical surfaces.
- Works to remove dirt, dust, fingerprints, nicotine and haze deposits.

Order No.	Mfg. No.	Size	List Price
290545	(05131)	6.9 fl. oz.	\$10.89

- Electronics
- Trolling Motors
- Instruments
- Electrical
- Lighting
- Anchor & Dock
- Safety
- Steering, Controls
- Pumps
- Fuel System
- Seating & Pedestals
- Trailer
- Tops & Covers
- Perform.
- Propellers
- Engine & Care
- Cleaning & Care
- Paint & Paint Acc.
- Fun & Flotation
- Topside Acc.
- Cockpit & Deck
- Hardware, Fasteners
- Camouflage
- Misc.
- Comm.

303® Marine Aerospace Protectant



- Powerful UV blockers prevent fading, cracking and premature aging.
- Dries to a clear matte finish.
- Restores lost color and luster.
- Easy to use: Simply spray on and wipe dry.
- Safe and effective for: Vinyl, Plexiglas, carbon fiber, rubber, plastics and finished leather.

Order No.	Mfg. No.	Size	List Price	
437419	(30305)	10 fl. oz.	\$10.99	Z0-6750000
437412	(30340)	16 fl. oz.	\$14.99	Z0-7780000
437421	(30306)	32 fl. oz.	\$24.99	Z0-3731000
437434	(30370)	Gallon	\$59.99	Z0-0424000

303® Mold & Mildew Cleaner + Blocker



- Quickly removes mold and mildew stains on contact.
- Blocks mold and mildew stains from re-occurring.
- Does not contain bleach, leaves behind a fresh scent.
- Works on ALL water-safe surfaces, including vinyl and fabrics.

Order No.	Mfg. No.	Size	List Price	
437472	(30573)	16 fl. oz.	\$13.99	Z0-6370000
437474	(30574)	32 fl. oz.	\$22.49	Z0-2711000

303® Marine Clear Vinyl Protective Cleaner

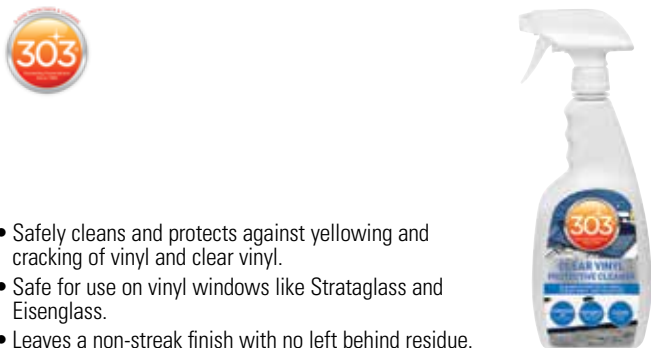

- Safely cleans and protects against yellowing and cracking of vinyl and clear vinyl.
- Safe for use on vinyl windows like Strataglass and Eisenglass.
- Leaves a non-streak finish with no left behind residue.
- Provides superior UV protection.

Order No.	Mfg. No.	Size	List Price	
437386	(30215)	32 fl. oz.	\$17.99	Z0-5401000

303® Marine Fabric Guard



- Fabric protector spray that strengthens and restores lost water repellency for marine fabrics.
- Safe for synthetic and natural fibers in marine environments.
- Protects against both water-based and oil-based stains.
- Does not alter fabric color, feel, flammability or breathability.
- Recommended by Sunbrella, leading outdoor fabric manufacturer.

Order No.	Mfg. No.	Size	List Price	
437447	(30616)	16 fl. oz.	\$17.99	Z0-1590000
437450	(30604)	32 fl. oz.	\$29.99	Z0-4561000
437453	(30674)	Gallon	\$79.99	Z0-7136000

303® Marine Multi-Surface Cleaner



- Removes soaked in, heavy stains on marine vinyl and fabric.
- Bring surfaces back to life with ultimate cleaning power.
- Leaves behind no greasy residue.
- Safely brightens and rejuvenates marine surfaces.

Order No.	Mfg. No.	Size	List Price	
437470	(30204)	32 fl. oz.	\$16.99	Z0-7180000
437440	(30570)	Gallon	\$39.99	Z0-5832000

303® Spot Cleaner

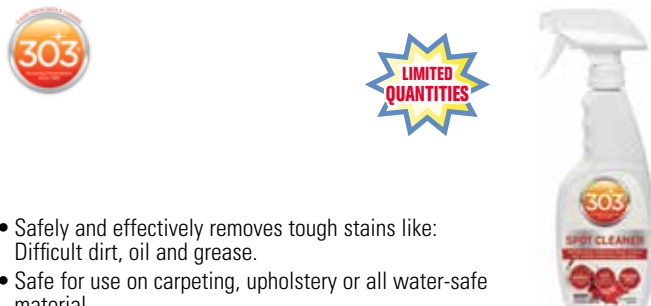

- Safely and effectively removes tough stains like: Difficult dirt, oil and grease.
- Safe for use on carpeting, upholstery or all water-safe material.
- Works as a spot remover and a general fabric cleaner.
- Easy to use, simply spray on and rinse off.

Order No.	Mfg. No.	Size	List Price	
4023452	(30222)	16 fl. oz.	\$5.89	Z0-5930000

- Electronics
- Trolling Motors
- Instruments
- Electrical
- Lighting
- Anchor & Dock
- Safety
- Steering, Controls
- Pumps
- Fuel System
- Seating & Pedestals
- Trailering
- Tops & Covers
- Perform.
- Propellers
- Engine & Care
- Cleaning & Care
- Paint & Paint Acc.
- Fun & Flotation
- Topside Acc.
- Cockpit & Deck
- Hardware, Fasteners
- Camouflage
- Misc.
- Comm.

303® Marine Speed Detailer



- Anti-static, repels dust, dirt and stains.
- Protects against light surface scratches.
- Powerful UV blockers protect your boat between washes and prevents paint fading.
- Quick and easy application.

Order No.	Mfg. No.	Size	List Price
437370	(30205)	32 fl. oz.	\$13.99

303® Marine Quick Wax



- The fastest boat wax solution for making your boat shine.
- Long lasting, water spot preventing spray on boat wax.
- Marine safe wax that gently cleans, and leaves a protective glossy shine.
- Provides UV Protection that prevents color fading.

Order No.	Mfg. No.	Size	List Price
437382	(30213)	32 fl. oz.	\$17.49

303® Marine Touchless Sealant



- Spray on, rinse off.
- Superior UV protection.
- Effective in both saltwater and freshwater environments.
- Biodegradeable and marine safe.

Order No.	Mfg. No.	Size	List Price
437423	(30398)	32 fl. oz.	\$19.99

Flitz Paste Polish



- Cream formula, non-toxic, eco-friendly.
- Safe for cleaning, polishing and protecting all metals, fiberglass, plastics and painted surfaces.
- Removes oxidation, tarnish, rust, water stains, heat discoloration, lead & powder residue, scuff marks and much more.

Order No.	Mfg. No.	Size	List Price
608005	(BP03511)	1.76 oz.	\$11.39
608010	(BU03515)	5.29 oz.	\$24.69
608015	(CA03518)	2 lb. Quart	\$60.69

Flitz Liquid Polish



- A diluted version of our original paste formula, this product is a high-performance cleaner and polish in a liquid form.
- Specially formulated to clean and polish with the ease and economy of a liquid, this concentrated formula goes three times farther than other liquids and leaves a brilliant shine in half the time.
- Cleans and polishes: Brass, Copper, Silverplate, Sterling Silver, Chrome, Stainless Steel, Nickel, Bronze, Solid Gold, Aluminum, Anodized Aluminum, Pewter and Factory Hot Gun Bluing.
- Removes: Tarnish, rust, water stains, heat discoloration, oxidation & fingerprints.

Order No.	Mfg. No.	Size	List Price
608025	(LQ 04587)	7.6 oz.	\$16.49
608030	(LQ 04506)	16 oz.	\$31.29

Davis FSR - Fiberglass Stain Remover



- It's ideal for removing oil, rust, exhaust, waterline and transom stains.
- Its nonabrasive quality means that it's safe to use on white painted surfaces as well as on gelcoat.
- Requires no sanding or compounding.
- Simply apply with a brush, sponge or cloth.

Order No.	Mfg. No.	Size	List Price
323458	(790)	16 fl. oz.	\$13.09
323460	(792)	67.8 fl. oz.	\$28.09

Corrosion Technologies ReJeX



- A thin-film polymer coating designed to provide a high-release protective finish for vehicles of all kinds.
- Prevents stains and adhesion of common contaminants such as exhaust, fish blood, bugs, bird droppings and mineral and tannin stains, etc.
- Protects and beautifies painted metal, glass, acrylic, gel coat, fiberglass, glossy plastic and polished metal surfaces.

Order No.	Mfg. No.	Size	List Price
302947	(61001)	12 fl. oz.	\$18.99

Toon-Brite Fiberglass Boat Cleaner



- Designed for DIY boaters.
- Removes algae, lime deposits, water stains and oxidation.
- Also great on painted wood.
- Priced Each. Sold in Case of 8 Only.
- Concentrate.

Order No.	Mfg. No.	Size	List Price
371849	(F-1000)	1/2 Gallon	\$22.19



- Electronics
- Trolling Motors
- Instruments
- Electrical
- Lighting
- Anchor & Dock
- Safety
- Steering, Controls
- Pumps
- Fuel System
- Seating & Pedestals
- Trailering
- Tops & Covers
- Perform.
- Propellers
- Engine & Care
- Cleaning & Care
- Paint & Paint Acc.
- Fun & Flotation
- Topside Acc.
- Cockpit & Deck
- Hardware, Fasteners
- Camouflage
- Misc.
- Comm.

OrProducts Boat Soap



- Concentrated boat soap. One ounce in 3 gallons of fresh or salt water will wash a medium size boat.
- Removes salt and dirt from boats, fishing tackle, trailers and cars.
- Is biodegradable and environmentally friendly.
- Cleans interiors and eliminates musty mildew odors.
- Cleans fish boxes and leaves a pleasant odor.
- Can be used on fiberglass, painted surfaces, all metals, wood, and plastics.
- Will not leave streaks.



Order No.	Mfg. No.	Size	List Price
447045	(OP-2)	Quart	\$23.99
447050	(OP-8)	Gallon	\$81.99

OrProducts Wash and Wax



- Is a concentrated boat soap with wax. One ounce in 3 gallons of water will wash and wax a medium size boat.
- Removes salt and dirt from boats, fishing tackle, trailers and cars, while providing a coat of wax protection.
- Cleans and waxes fish boxes for easy next trip clean-up and removes fish odors.
- Is biodegradable and environmentally friendly.
- Can be used on fiberglass, does not remove wax, all metals, wood, and plastics to protect and provide a pleasing surface appearance.
- Leaves a clean, non-yellowing coat of wax protection on boats and cars.



Order No.	Mfg. No.	Size	List Price
447030	(OPW-2)	Quart	\$26.49
447040	(OPW-8)	Gallon	\$88.19

Spray Nine - Multi-Purpose Cleaner



- A multi-purpose cleaner and disinfectant that works above and below deck.
- Kills germs, removes stains and yellowing and eliminates bacterial odors with little effort.
- Use regularly to control mold and mildew on vinyl, carpets and hard surfaces.
- Priced Each. Sold in Case Lots Only.

Order No.	Size	List Price
437056	32 fl. oz. 12 Per Case	\$8.59
437068	Gallon 6 Per Case	\$22.69

Mighty Mike® Marine Multi-Purpose Cleaner



- Cleans nearly everything effectively without leaving residues or surface damage!
- A botanical mixture that contains no harmful detergents, solvents, perfumes or dyes, the Mighty Mike Marine Multi-Purpose Cleaner effectively targets the stain, not the surface.
- Certified SAFE FOR ALL BODIES OF WATER.



Order No.	Mfg. No.	Size	List Price
640208	(T5684)	32 fl. oz.	\$30.59

Toon-Brite Pontoon and Aluminum Boat Cleaner



- The easiest cleaner you'll ever use.
- Designed for the do-it-yourself boater.
- Removes algae, lime deposits, water stains and oxidation.
- Simply spray on and rinse off!

Order No.	Mfg. No.	Size	List Price
371847	(B-1000)	1/2 Gallon (Priced Each, Case of 8)	\$22.19
2001330	(B1004)	Gallon	\$30.79
2001317	(B1015)	15 Gallon - S/O Only	\$342.79

Nevr-Dull



- "Magic" wadding polish for cleaning and polishing all metals.
- Cleans brass, aluminum, steel, chrome and other metals.
- Removes rust, tar and rubber sole marks.

Order No.	Size	List Price
457526	5 oz.	\$10.49

Snee Aluminum Brightener and Fiberglass Cleaner



- Aluminum brightener specifically selected acids and stable wetting agents designed to clean and brighten anything aluminum.
- Priced each. Sold in Case of 4 Only.

Order No.	Mfg. No.	Size	List Price
437010	(06 AB)	Gallon	\$35.89

SPECIAL HANDLING MAY APPLY



- Electronics
- Trolling Motors
- Instruments
- Electrical
- Lighting
- Anchor & Dock
- Safety
- Steering, Controls
- Pumps
- Fuel System
- Seating & Pedestals
- Trailer
- Tops & Covers
- Perform.
- Propellers
- Engine & Care
- Cleaning & Care
- Paint & Paint Acc.
- Fun & Flotation
- Topside Acc.
- Cockpit & Deck
- Hardware, Fasteners
- Camouflage
- Misc.
- Comm.

Wechem D-Rust



- One-Step Rust Neutralizer and Metal Primer.
- This new surface conditioner and primer changes rust into a dark protective polymeric coating.
- It converts existing rust to an inert coating that seals out moisture to prevent future rust and corrosion.
- Surfaces protected with this primer and an oil-based paint system resists the effects of weather, rain, sun and salt spray without peeling or cracking.
- This easy-to-use product is the first step in providing long-term protection of steel and iron surfaces.

Order No. Mfg. No. Size List Price
437034 (RX10) Gallon **\$114.29** B0-6820100

Wechem AL-600 Aluminum Brightener and Cleaner



- A safer alternative, that replaces hydrofluoric, sulfuric, phosphoric and hydrochloric acids, which restores the "like new" appearance to surfaces.
- This concentrated solution quickly and effortlessly removes dirt, soot, oxidation and other soils from a wide variety of surfaces including aluminum, stainless steel and some fiberglass.
- This product is the formulation of choice when economy and speed are essential.

Order No. Mfg. No. Size List Price
437009 (AC1504) Gallon **\$27.09** B0-8342000

Wechem Rust Bust



- RUST BUST is a special labor-saving formulation designed to replace costly, labor intensive rust removal procedures.
- The simple one-step, no rinse process completely protects metal surfaces.
- RUST BUST is ideal for use on most metal surfaces; testing for sensitivity on a small area is recommended.

Order No. Mfg. No. Size List Price
200036 (AC3254) Gallon **\$18.69** B0-2861000

Gold Eagle Sta-Bil® Rust Stopper



- Prevents rust and corrosion.
- Long lasting protection.
- Water resistant.
- Lubricates and penetrates.
- Stops existing rust.

Order No. Mfg. No. Size List Price
2890036 (22003) 13 fl. oz. **\$9.89** Z0-9860000

Permatex Super Clear Vinyl Sealant Repair Kit



- Makes invisible repairs from rips, cuts and tears to upholstery, luggage, clothing, etc.
- Contains: Clear vinyl sealant and filler (net 1.5 fl. oz.), special applicator nozzle, grain pattern paper.

Order No. Mfg. No. / Description List Price
5450124 (81786) **\$5.29** H0-7130000

Permatex Ultra Series Vinyl & Leather Repair Kit



- Contains: Professional electric heat tool, 7 color compounds, clear vinyl adhesive and filler (net .34 fl. oz.), grain pattern paper, metal spatula, plastic dashboard hardening powder.

Order No. Mfg. No. / Description List Price
5450123 (81781) **\$26.79** H0-7061000

Permatex Fast Orange Hand Cleaner



- Biodegradable, waterless, petroleum solvent-free hand cleaner that contains no harsh chemicals, mineral oils or ammonia.
- Pure, fresh-smelling natural citrus power does the cleaning.
- Fortified with aloe, lanolin, glycerin and other skin conditioners to soothe raw, rough hands.
- Fine Pumice deep cleans the toughest dirt.

Order No. Mfg. No. Size List Price
545206 (25122) 15 fl. oz. **\$4.19** H0-1520000
545218 (25219) Gallon with Pump **\$22.59** H0-5531000

- Electronics
- Trolling Motors
- Instruments
- Electrical
- Lighting
- Anchor & Dock
- Safety
- Steering, Controls
- Pumps
- Fuel System
- Seating & Pedestals
- Trailering
- Tops & Covers
- Perform.
- Propellers
- Engine & Care
- Cleaning & Care
- Paint & Paint Acc.
- Fun & Flotation
- Topside Acc.
- Cockpit & Deck
- Hardware, Fasteners
- Camouflage
- Misc.
- Comm.

- Electronics
- Trolling Motors
- Instruments
- Electrical
- Lighting
- Anchor & Dock
- Safety
- Steering, Controls
- Pumps
- Fuel System
- Seating & Pedestals
- Trailering
- Tops & Covers
- Perform.
- Propellers
- Engine & Care
- Paint & Paint Acc.
- Fun & Flotation
- Topside Acc.
- Cockpit & Deck
- Hardware, Fasteners
- Camouflage
- Misc.
- Comm.

Oil Mop Absorbent Spill Kit



517221



- Approximate absorption 95 to 115 gallons.
- Oil Mop Absorbent Spill Kit includes:
 - (1) 55 gallon drum
 - (50) Light weight pads - 15" x 17"
 - (10) Sorbent socks - 3" x 4"
 - (10) Sorbent pillows - 10" x 10"
 - (1) Sorbent boom - 5" x 10"
 - (3) Disposable bags
 - (1) Pair of nitrile gloves

Order No.	Mfg. No. / Description	List Price	
517219	(O-SK-55GAL)	\$395.19	F0-3667200

SORBENT BOOM

Order No.	Mfg. No. / Description	List Price	
517221	(O-B-B510) 5" x 10'	\$22.89	F0-2061000
517233	(O-B-B810) 8" x 10'	\$30.09	F0-6012000

Snee All Purpose Absorbent



Order No.	Mfg. No. / Description	List Price	
436976	(FLX 2)	\$16.19	F0-3311000

Star Brite Oil Absorbent Sheets



- Quickly absorbs oil and fuel, but will not absorb water.
- Absorbs up to 15 times its weight in oil/fuel.
- Made of high-quality, virgin materials; will not unravel.
- Can be wrung out and re-used.
- Ideal for wrapping fuel nozzle to prevent refueling spills.
- Dimensions: 15" x 19".



Order No.	Mfg. No. / Description	List Price	
461152	(91845) 5 Per Pack	\$8.19	G0-9450000

3M Petroleum Sorbent Pads



- For use in oil-only Sorbent applications.
- Pads are conveniently sized and can be quickly spread on and in the path of a thin spill.
- May be used on a work surface in anticipation of a spill.
- Ideal for use under docks, in shallow water, rocky shorelines, marshes and beaches.
- Dimensions: 19" L x 17" W.

SOLD 100 PADS PER CASE

Order No.	Mfg. No.	Absorption Capacity	List Price	
852461	(28991) HP-156	37.5 Gallon	\$106.39	H0-3836000

SOLD 200 PADS PER CASE

Order No.	Mfg. No.	Absorption Capacity	List Price	
852460	(16049) T-151	43.5 Gallon	\$202.79	F0-5914100

Star Brite Bulk Bilge Pads - Single Weight



- Special absorbent material soaks up oil and fuel but repels water.
- Absorbs up to 15 times its weight in oil/fuel.
- Great for bilge areas, engine rooms or anywhere oil or petrochemicals are spilled.
- Virgin material does not shred like recycled imitations.
- Dimensions: 15" x 19".

Order No.	Mfg. No. / Description	List Price	
461145	(091820) 200 Bail	\$186.89	G0-2252100

Star Brite Maxi Boom Oil Absorber



- Absorbs oil/fuel in the bilge so that remaining water may be pumped overboard.
- Convenient tie downs keep booms in place.
- Special design allows maximum absorption.
- Absorbs 2 quart of hydrocarbons.
- Dimensions: 5" x 18".



Order No.	Mfg. No. / Description	List Price	
461150	(86805)	\$14.99	G0-4001000

SPECIAL HANDLING MAY APPLY



3M Finesse-It™ Natural Buffing Pad - Diameter 3"



- Provides the most aggressive cutting action in the Finesse-it line for fast removal of sanding scratches in conjunction with 3M Finesse-it polishes.
- Dense natural pile conforms to contours for even finishing.
- Aggressive cut quickly removes oxidation and scratches with less heat buildup.
- 3M Hookit attachment system holds pad securely and provides quick disc/pad change-out.
- Pads combine with buffers, random orbital tools, and variable speed polishers to produce desired final finish.
- Sold 10 per bag.



Order No.	Mfg. No. / Description	List Price
857085	(81470) Diameter 3"	\$115.89 F0-2118000

3M Perfect-It™ Foam Polishing Pad - Diameter 8"



- High performance black double sided foam polishing pad.
- Removes compound swirl marks and fine paint surface defects.
- Unique quick connect design.
- For use with 3M Perfect-It EX Machine Polish (06093, 06094 and 06095).
- Use with 3M Quick Connect Adaptor **857152** (05752).
- Sold each.



Order No.	Mfg. No. / Description	List Price
857103	(05707) Diameter 8"	\$41.19 F0-3882000

3M Perfect-It™ Foam Compounding Pad - Diameter 9"



- High performance double sided foam compounding pad.
- Refines P1200 or finer sand scratches.
- Unique quick connect design.
- For use with 3M Perfect-It EX AC Rubbing Compound (39060 and 36061).
- Use with 3M Quick Connect Adaptor **857152** (05752).
- Sold each.

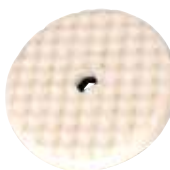

Order No.	Mfg. No. / Description	List Price
857080	(05706) Diameter 9"	\$39.49 F0-4672000

3M Wool Compounding Pad - Diameter 9"



- Removes finishing abrasive sand scratches and other paint surface defects.
- Double sided screw-on pads feature flexing action for reduced surface burn risk.
- Untwisted wool yarn construction improves handling across large surface areas.
- Blended or 100 percent wool abrasive delivers fast-cutting efficiency.
- For use with 3M Perfect-It EX Rubbing Compounds (36058, 36060 and 36061).
- Use with 3M Screw On Buffing Pad Adaptor **857135** (05710).
- Sold each.



Order No.	Mfg. No. / Description	List Price
857087	(33280) Diameter 9"	\$37.49 F0-4262000

3M Perfect-It™ Foam Polishing Pad - Diameter 8"



- Convoluted-foam design glides smoothly over painted surfaces.
- Delivers a swirl-free finish.
- Eliminates minor scratches and scuffs.
- Applies machine polish evenly and consistently.
- For use with 3M Perfect-It Machine Polish (06053, 06064, 06065 and 39061) and 3M Hookit Back-Up Pads (05717 and 05718).
- Proven performer.
- Sold 2 per bag.

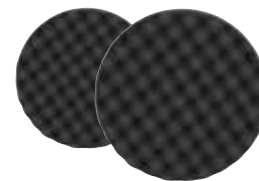

Order No.	Mfg. No. / Description	List Price
857133	(05725) Diameter 8"	\$46.09 F0-6223000

3M Perfect-It™ Ultrafine Foam Polishing Pad - Diameter 8"



- High performance blue double sided foam polishing pad.
- Eliminates swirl marks on painted surfaces.
- Unique quick connect design.
- For use with 3M Perfect-It EX Ultrafine Machine Polish (39062, 06068 and 06069).
- Use with 3M Quick Connect Adaptor **857152** (05752).
- Sold each.

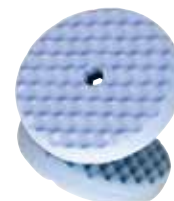

Order No.	Mfg. No. / Description	List Price
857104	(05708) Diameter 8"	\$44.99 F0-9413000

3M Perfect-It™ Wool Compounding Pad - Diameter 9"



- High performance double sided 100% wool compounding pad.
- Refines P1200 and finer sand scratches and other paint surface defects.
- Unique quick connect design.
- For use with 3M Perfect-It EX AC Rubbing Compound (39060 and 36061).
- Use with 3M Quick Connect Adaptor **857152** (05752).
- Sold each.



Order No.	Mfg. No. / Description	List Price
857153	(05753) Diameter 9"	\$43.19 F0-3203000

3M Hookit™ 60:40 Wool Blend Compounding Pad - Diameter 9"



- Single sided blended wool compounding pad used to refine P1200 and finer sand scratches and other paint surface defects.
- For use with 3M Perfect-It EX Rubbing Compounds (36058, 36060 and 36061).
- Hookit attachment uses 05717 and 05718 backing plate.
- Use with 3M Screw On Buffing Pad Adaptor **857135** (05710).
- Sold each.



Order No.	Mfg. No. / Description	List Price
857106	(05711) Diameter 9"	\$27.89 F0-2591000

- Electronics
- Trolling Motors
- Instruments
- Electrical
- Lighting
- Anchor & Dock
- Safety
- Steering, Controls
- Pumps
- Fuel System
- Seating & Pedestals
- Trailer
- Tops & Covers
- Perform.
- Propellers
- Engine & Care
- Cleaning & Care
- Paint & Paint Acc.
- Fun & Flotation
- Topside Acc.
- Cockpit & Deck
- Hardware, Fasteners
- Camouflage
- Misc.
- Comm.

3M Wool Blend Compounding Pad - Diameter 9"



- Double Sided Blended Wool Compounding pad used to refine P1200 and finer sand scratches and other paint surface defects.
- For use with 3M Compounds.
- Use with 3M Screw On Buffing Pad Adaptor **857135** (05710).
- Sold each.

Order No. Mfg. No. / Description List Price
857071 (05704) Diameter 9" **\$51.09** F0-6753000

3M Wool Polishing Pads - Diameter 9"



- Removes fine paint defects including compound swirl marks.
- Blended wool abrasive uses fast cut for efficient, effective results.
- Double sided soft edge pads protect body and style lines.
- Single side pads feature hook and loop attachment for fast change-outs.
- Use with 3M Machine Polishes and 3M Screw On Buffing Pad Adaptor **857135** (05710).
- Sold each.

Order No. Mfg. No. / Description List Price
857089 (33282) Double Sided **\$38.89** F0-2272000

3M Wool Polishing Pad - Diameter 9"



- Double sided yellow blended wool polishing pad; removes compound swirl marks and fine paint surface defects.
- Use with 3M Machine Polishes.
- Use with 3M Screw On Buffing Pad Adaptor **857135** (05710).
- Sold each.

Order No. Mfg. No. / Description List Price
857079 (05705) Diameter 9" **\$55.39** F0-7783000

3M Perfect-It™ Back-Up Pad - Diameter 7"



- Hookit back-up pad allows for easy attachment, quick removal and accurate centering of single sided compounding or polishing pads.
- Enables users to attach pads without having to remove the 3M Adaptor 05710.
- Dimensions: 7" x 3/4" x 5/8-11.
- Sold each.

Order No. Mfg. No. / Description List Price
857121 (05718) Diameter 7" **\$93.99** F0-9756000

3M 100% Wool Compounding Pad - Diameter 9"



- Double sided 100% wool compounding pad used to refine P1200 and finer sand scratches and other paint surface defects.
- For use with 3M Perfect-It EX Rubbing Compounds (36058, 36060 and 36061).
- Use with 3M Screw On Buffing Pad Adaptor **857135** (05710).
- Sold each.

Order No. Mfg. No. / Description List Price
857069 (05703) Diameter 9" **\$48.29** F0-0833000

3M Perfect-It™ Wool Polishing Pad - Diameter 9"



- Double-sided pad provides fast, easy change-outs.
- Use to remove compound swirl marks on automotive paint and gelcoat.
- Blended wool abrasive combines fast cut and fine finish.
- Quick Connect attachment provides fast, easy centering of pads, reducing operator fatigue.
- For use with **857152** (05752) 3M Quick Connect Adaptor.
- Sold each.

Order No. Mfg. No. / Description List Price
857154 (05754) Diameter 9" **\$47.99** F0-9533000

3M Wool Polishing Pad - Diameter 9"



- Single sided yellow blended wool polishing pad; removes compound swirl marks and fine paint surface defects.
- Use with 3M Machine Polishes and **857120** (05717) or **857121** (05718) 3M Back-Up Pads.
- Use with 3M Screw On Buffing Pad Adaptor **857135** (05710).
- Sold each.

Order No. Mfg. No. / Description List Price
857118 (05713) Diameter 9" **\$30.89** F0-2612000

3M Hookit™ Back-Up Pad - Diameter 7"



- Hookit back-up pad allows for easy attachment, quick removal and accurate centering of single sided compounding or polishing pads.
- Dimensions: 7" x 3/4" x 5/8-11.
- Sold each.

Order No. Mfg. No. / Description List Price
857120 (05717) Diameter 7" **\$91.09** F0-6736000

3M Perfect-It™ Quick Connect Adaptor



- Polisher adaptor used to quickly connect and disconnect double sided buffing pads.
- Use with 3M Perfect-It brand compounding and polishing pads.
- Makes it easy to change between compound and polishing pads.
- 5/8" threads.

Order No.	Mfg. No. / Description	List Price
857152	(05752)	\$41.89 F0-2392000

3M Screw On Buffing Pad Adaptor



- Adaptor for use with 3M Buffing Pads (05703, 05704 and 05705).
- Works with **857121** (05718) 3M Perfect-It Back-Up Pad.
- 5/8" threads.

Order No.	Mfg. No. / Description	List Price
857135	(05710)	\$17.39 F0-7121000

Star Brite Long Handle Utility Brush



- 2" bristle trim.
- Excellent for cleaning hard to reach baitwells, waterlines, bilges, etc.
- Length overall 20".

Order No.	Mfg. No. / Description	List Price
675894	(40026)	\$12.19 G0-7180000

Magnolia Fender Wash Brush



- Filling material is staple set in wax tumbled hardwood block with hang up hole in handle.
- Length of trim: 2".
- Block dimensions: 20" L x 3" W.
- Brown plastic.

Order No.	Mfg. No. / Description	List Price
575033	(MB70)	\$8.99 F0-9260000

Star Brite Utility Scrub Brush



- Features Star prene fibers with flagged ends to hold water and cleaning solutions for easier washing.
- Ideal for scrubbing hard to reach areas, waterlines, baitwells, etc.

Order No.	Mfg. No. / Description	List Price
675892	(40025)	\$8.19 G0-9450000

Star Brite Hand Scrub Brush



- Chemically resistant bristles.
- Molded plastic block with comfortable finger indents on the handle.
- Medium bristles are great for general cleaning.
- Ideal for cleaning all surfaces including vinyl.

Order No.	Mfg. No. / Description	List Price
675896	(40027)	\$7.89 G0-9250000

Star Brite Stainless Steel Bristle Utility Brush



- Stainless steel bristles with scrapper.
- Hard wood handle.
- 1-1/8" bristle trim.
- Block dimensions: 10" x 1-1/8".

Order No.	Mfg. No. / Description	List Price
675910	(040058)	\$14.49 G0-1790000

Star Brite Stainless Steel Bristle Cleaning Brush



- Stainless steel bristles.
- Hard wood handle.
- 1-3/16" bristle trim.
- Block dimensions: 14" x 1-1/8".

Order No.	Mfg. No. / Description	List Price
675912	(40059)	\$14.99 G0-4001000

Star Brite Detail Brushes with Plastic Handle



- Plastic handle is molded with comfortable finger grips.
- 1/2" bristle trim.
- Block size is 7-3/4" x 7/16".

Order No.	Mfg. No.	Bristles	List Price
675914	(040062)	Nylon	\$3.79 G0-4520000
675916	(40063)	Brass	\$3.79 G0-4520000
675918	(40064)	Stainless Steel	\$3.79 G0-4520000

- Electronics
- Trolling Motors
- Instruments
- Electrical
- Lighting
- Anchor & Dock
- Safety
- Steering, Controls
- Pumps
- Fuel System
- Seating & Pedestals
- Trailer
- Tops & Covers
- Perform.
- Propellers
- Engine & Care
- Cleaning & Care
- Paint & Paint Acc.
- Fun & Flotation
- Topside Acc.
- Cockpit & Deck
- Hardware, Fasteners
- Camouflage
- Misc.
- Comm.

Magnolia Deck Brush



- Stiff palmyra fiber.
- Staple set in a smooth sanded hardwood block with one threaded and one tapered handle hole.
- Length 10". Length of trim: 2".

Order No.	Mfg. No. / Description	List Price
575057	(MB110)	\$6.99 F0-9840000

Magnolia Deck Brush



- Filled with high quality polypropylene.
- Staple set in a smooth sanded hardwood block with one threaded and one tapered handle hole.
- Length 10". Length of trim: 2".

Order No.	Mfg. No. / Description	List Price
575069	(MB310Y) Yellow	\$8.09 F0-6650000

Magnolia Wash Brush



- Filling material is staple set in foam plastic block with protective bumper.
- Has one threaded and one tapered handle hole.
- Length 10". Length of trim: 3".

Order No.	Mfg. No. / Description	List Price
575088	(MB3032)	\$17.89 F0-2521000

Star Brite 8" Deluxe Block Brushes with Bumper



- Fibers with flagged ends.
- Bumper protects against scuff marks and surface damage.
- Fits all Extend-A-Brush handles.

Order No.	Mfg. No. / Description	List Price
675958	(40161) Soft Wash Brush Yellow	\$22.79 G0-7251000
675960	(40162) Medium Wash Brush Blue	\$22.79 G0-7251000
675962	(40163) Scrub Brush White	\$22.79 G0-7251000

Star Brite Premium 8" Synthetic Wood Block Brushes with Bumper



- Lightweight synthetic block combines the beauty of wood with extreme durability.
- Impervious to exposure to UV rays, cleaning agents and weather.
- Bumper edges help prevent scuff marks.
- Will only fit quick connect handles.

Order No.	Mfg. No. / Description	List Price
675950	(40170) Soft Wash Brush Yellow	\$39.99 G0-9762000
675952	(40171) Medium Wash Brush Blue	\$39.99 G0-9762000
675954	(40172) Scrub Brush White	\$39.99 G0-9762000

Swobbit Deck Brushes



- 7.5" wide molded poly block with premium quality flared bristles set with corrosion resistant staples.
- Wrap around safety bumper protects surrounding areas.
- Uni-Snap adapter molded into block.

Order No.	Mfg. No. / Description	List Price
460222	(SW77340) Extra Soft Bristle	\$33.39 F0-7332000
460220	(SW77345) Soft Flagged Bristle	\$33.39 F0-7332000
460218	(SW77350) Medium Bristle	\$29.89 F0-2902000
460232	(SW77355) Stiff Bristle	\$29.89 F0-2902000

- Electronics
- Trolling Motors
- Instruments
- Electrical
- Lighting
- Anchor & Dock
- Safety
- Steering, Controls
- Pumps
- Fuel System
- Seating & Pedestals
- Trailering
- Tops & Covers
- Perform.
- Propellers
- Engine & Care
- Paint & Paint Acc.
- Fun & Flotation
- Topside Acc.
- Cockpit & Deck
- Hardware, Fasteners
- Camouflage
- Misc.
- Comm.

Cleaning & Care

Star Brite Premium Heavy Duty Extending Handle



- Lightweight and incredibly strong.
- Constructed of heavy duty aircraft grade, triple anodized aluminum.
- Telescoping shafts feature two non-slip hand grips with positive twist lock.
- Stainless steel push button quick connect/disconnect allows for instant attachment of all Extend-A-Brush accessories.
- Designed to float if dropped overboard.

Order No. **675956** Mfg. No. / Description (40155) Length 3' - 6' List Price **\$39.09** GO-9162000

Star Brite Standard Extending Handle



- Constructed of aircraft grade, triple anodized aluminum.
- Telescoping shafts feature two non-slip hand grips with positive twist lock.
- Stainless steel push button quick connect/disconnect allows for instant attachment of all Extend-A-Brush accessories.
- Designed to float if dropped overboard.

Order No. **675870** Mfg. No. / Description (40000) Length 3' - 6' List Price **\$29.59** GO-3891000

Ever Tough Anodized Aluminum/Fiberglass Extension Pole



- Anodized aluminum/fiberglass construction.
- Double grooved.
- Heavy duty exclusive variable locking mechanism.
- Comfort foam handle.

Order No. **460117** Mfg. No. / Description (RPNS4876) Length 4' - 8' List Price **\$45.09** HO-5072000

Pro Everlok Anodized Aluminum Extension Pole



- Anodized aluminum construction.
- Double grooved.
- Exclusive variable position positive locking mechanism.
- Heavy duty aluminum threaded tip. Large foam padded handle.

Order No. **460105** Mfg. No. / Description (RPE136) Length 3' - 6' List Price **\$33.39** HO-3002000

Star Brite Economy Handle



- A durable, very attractive one-piece handle that accepts screw-on accessories.
- Outlasts traditional wooden economy brushes.

Order No. **675872** Mfg. No. / Description (40007) Length 4' List Price **\$9.09** GO-9060000

Star Brite Wooden Handle with Screw Thread End



- An affordable, traditional, very durable 5' wooden handle that accepts screw-on accessories.

Order No. **675924** Mfg. No. / Description (40088) Length 5' List Price **\$8.79** GO-9850000

Corona Wood Extension Pole with Die Cast Metal Tip



- Unlacquered hardwood extension pole with heavy duty die cast metal threaded tip.

Order No. **575071** Mfg. No. / Description (R-1249-DCM) Length 49" List Price **\$5.89** HO-3530000



SPECIAL HANDLING MAY APPLY



- Electronics
- Trolling Motors
- Instruments
- Electrical
- Lighting
- Anchor & Dock
- Safety
- Steering, Controls
- Pumps
- Fuel System
- Seating & Pedestals
- Trailer
- Tops & Covers
- Perform.
- Propellers
- Engine & Care
- Cleaning & Care**
- Paint & Paint Acc.
- Fun & Flotation
- Topside Acc.
- Cockpit & Deck
- Hardware, Fasteners
- Camouflage
- Misc.
- Comm.

Swobbit Perfect Poles™ - Telescoping Poles

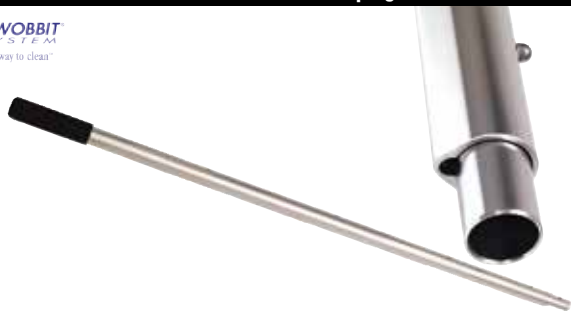

- Teardrop design makes Perfect Pole up to 67% stronger than other telescoping handles.
- Comfortable hand grip.
- Patented no-lock tracking system for foolproof adjustments.
- Outer pole is made of custom extruded, heat treated, anodized aluminum.
- Inner pole is made of drawn 6063 T8 heat treated, anodized aluminum.
- It's also perfect for use with our Gaff Hook and Net to land that big catch.

Order No.	Mfg. No. / Description	List Price	
460208	(SW45640) Length 2' - 4'	\$22.99	FO-9061000
460206	(SW45650) Length 3' - 6'	\$34.59	FO-1242000
460193	(SW45660) Length 5' - 9'	\$47.49	FO-4233000
460181	(SW45670) Length 6' - 11'	\$63.79	FO-5644000

Swobbit Fixed Length Handle



- A lightweight alternative to telescoping handles.
- Made of 6063 T8 drawn, heat treated, anodized aluminum.

Order No.	Mfg. No. / Description	List Price	
460331	(SW46710) Length 4'	\$19.89	FO-2931000

Marpac Deck Brush with 4' Aluminum Handle



- Deck brush with basic 4' aluminum handle with added rubber bumper, mar resistant head - medium soft bristles.
- Deluxe has telescopic aluminum handle, non-slip cam lock for positive no leak on-off use.

Order No.	Description	List Price	
7-52702	Deck Brush	\$16.59	GO-2111000

Swobbit Deluxe Cleaning Kit



- Kit includes: (1) 460206 (SW45650) Perfect Pole - Telescoping pole, 3' - 6', (1) 460220 (SW77345) Soft flagged deck brush, (1) 460333 (SW66650) Universal boat hook, (1) SW56301 - Micro fiber towel and (1) 460475 (SW61850) Synthetic wash mitt.

Order No.	Mfg. No. / Description	List Price	
460381	(SW82000)	\$54.69	FO-8283000

Swobbit Threaded Uni-Snap Adapter



- Allows you to use the Perfect Pole with a standard ACME threaded product.
- Snaps into the Perfect Pole converting it into a threaded end product.
- Made of drawn, heat treated anodized aluminum with a glass filled nylon tip.

Order No.	Mfg. No. / Description	List Price	
460258	(SW66610)	\$6.09	FO-6240000

Star Brite Standard Extending Handle with 8" Deluxe Brush



- Pole extends from 3' to 6'; features two non-slip hand grips and positive twist lock.
- Constructed with aircraft grade, triple anodized aluminum.
- Includes 8" deluxe brush with bumper.
- Designed to float if dropped overboard.

Order No.	Mfg. No. / Description	List Price	
625900	(040191) With Soft Wash Brush	\$48.59	GO-6523000
675964	(40192) With Medium Wash Brush	\$48.59	GO-6523000

SPECIAL HANDLING MAY APPLY



- Electronics
- Trolling Motors
- Instruments
- Electrical
- Lighting
- Anchor & Dock
- Safety
- Steering, Controls
- Pumps
- Fuel System
- Seating & Pedestals
- Trailer
- Tops & Covers
- Perform.
- Propellers
- Engine & Care
- Cleaning & Care
- Paint & Paint Acc.
- Fun & Flotation
- Topside Acc.
- Cockpit & Deck
- Hardware, Fasteners
- Camouflage
- Misc.
- Comm.

Swobbit Landing Net - Pear Shape

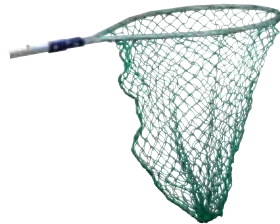

- Perfect for retrieving overboard items or landing fish.
- Large, light to medium weight, not intended for landing heavy fish or objects.
- Uni-Snap adapter attaches to Perfect Pole telescoping handle.
- Dimensions: 17" x 27" x 30".

Order No.	Mfg. No. / Description	List Price	
460337	(SW66680)	\$27.09	F0-6981000

Attwood Fold-N-Stow Fishing Nets



- Constructed of durable knot-free netting.
- Fold down for convenient and compact storage or extend for added reach with Attwood's new line of Fold-N-Stow Fishing Net.
- A flip of the handle opens and locks the net into place.
- Easily pull back the trigger and the net collapses down into an easily stowable size.

Order No.	Mfg. No. / Description	List Price	
334008	(12773-2) Medium 47" L x 16" W x 16" D	\$16.09	F0-6211000
334010	(12774-2) Large 81" L x 27" W x 27" D	\$26.39	F0-7481000

Swobbit Brush and Pole Display



- Display consists of:
 - (5) SW45640 Perfect Poles, Length 2' - 4'
 - (5) SW45650 Perfect Poles, Length 3' - 6'
 - (4) SW45660 Perfect Poles, Length 5' - 9'
 - (5) SW46710 Fixed Length Handle, Length 4'
 - (4) SW77340 Deck Brush - 7.5" Extra Soft Bristle
 - (4) SW77345 Deck Brush - 7.5" Soft Flagged Bristle
 - (4) SW77350 Deck Brush - 7.5" Medium Bristle
 - (4) SW77355 Deck Brush - 7.5" Stiff Bristle
 - (1) SW91025 Merchandiser Brush & Pole

Order No.	Mfg. No. / Description	List Price	
460491	(SW93200)	\$1,082.49	F0-4775700

Swobbit Island Merchandise Display



- Display consists of:
 - (4) SW45640 Perfect Pole - Telescoping Pole, 2' - 4'
 - (12) SW45650 Perfect Pole - Telescoping Pole, 3' - 6'
 - (12) SW45660 Perfect Pole - Telescoping Pole, 5' - 9'
 - (4) SW46700 Fixed Length Handle, Length 2'
 - (4) SW46710 Fixed Length Handle, Length 4'
 - (4) SW77340 Deck Brush - 7.5" Extra Soft Bristle
 - (4) SW77345 Deck Brush - 7.5" Soft Flagged Bristle
 - (4) SW77350 Deck Brush - 7.5" Medium Bristle
 - (4) SW77355 Deck Brush - 7.5" Stiff Bristle
 - (3) SW19140 Soft Washing Tool Uni-Snap
 - (3) SW19150 Synthetic Replacement Bonnet for Washing Tool
 - (4) SW21414 Quik Dry Water Blade, 14"
 - (4) SW21215 Quik Dry Adapter
 - (4) SW31315 Aquazorber Drying Mop
 - (3) SW38855 Aqua Dry PVA Cloth, 3.19 sq. ft.
 - (4) SW55450 Dual-Axis Swivel Plate
 - (3) SW55220 Scrub Pads White, Fine (2 pack)
 - (3) SW55230 Scrub Pads Blue, Medium (2 pack)
 - (3) SW55240 Scrub Pads Brown, Coarse (2 pack)
 - (3) SW61865 Chenille Micro Fiber Mitt
 - (4) SW66610 Threaded Adapter
 - (4) SW61855 Sheepskin Wash Mitt with Thumb
 - (4) SW66650 Universal Boat Hook
 - (1) SW93310 Portable Island Merchandiser

Order No.	Mfg. No. / Description	List Price	
460496	(SW93300)	\$2,435.99	F0-9150710

- Electronics
- Trolling Motors
- Instruments
- Electrical
- Lighting
- Anchor & Dock
- Safety
- Steering, Controls
- Pumps
- Fuel System
- Seating & Pedestals
- Trailering
- Tops & Covers
- Perform.
- Propellers
- Engine & Care
- Cleaning & Care
- Paint & Paint Acc.
- Fun & Flotation
- Topside Acc.
- Cockpit & Deck
- Hardware, Fasteners
- Camouflage
- Misc.
- Comm.



SPECIAL HANDLING MAY APPLY



- Electronics
- Trolling Motors
- Instruments
- Electrical
- Lighting
- Anchor & Dock
- Safety
- Steering, Controls
- Pumps
- Fuel System
- Seating & Pedestals
- Trailering
- Tops & Covers
- Perform.
- Propellers
- Engine & Care
- Paint & Paint Acc.
- Fun & Flotation
- Topside Acc.
- Cockpit & Deck
- Hardware, Fasteners
- Camouflage
- Misc.
- Comm.

Swobbit Quik Dry™ Adapter



- Quik Dry Adapter allows you to use the 14" or 18" water blade with the Perfect Pole Telescoping Handle.
- Dry hard to reach areas like decks, hardtops, roofs, hull sides and more, quickly and easily.
- Adapter is adjustable to 180°.

Order No.	Mfg. No. / Description	List Price
460268	(SW21215)	\$10.69 F0-8470000

Swobbit Micro Fiber Chenille

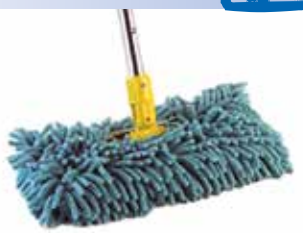

- Super-soft micro fiber strands gently wash paint, fiberglass, windows and enclosures.
- Holds plenty of soap and water.
- Dual-axis swivel head follows curves and contours for quick washing.

Order No.	Mfg. No. / Description	List Price
460252	(SW19170)	\$28.79 F0-5102000

Swobbit Soft Washing Tool Uni-Snap



- Over 70 sq. inches of cleaning surface.
- Dual-axis swivel head follows curves and contours for quick washing.
- Safe for all finishes including paint, fiberglass, windows and enclosures.

Order No.	Mfg. No. / Description	List Price
460256	(SW19140) Soft Washing Tool Uni-Snap	\$29.19 F0-3402000
460245	(SW19150) Synthetic Replacement Bonnet	\$13.69 F0-8590000

Swobbit Dual-Axis Swivel Plate



- Made of durable ABS Plastic.
- Dual-Axis Swivel Plate features heavy duty hooks to securely attach Swobbit System scrub pads.
- Uni-Snap adapter is designed to work with the Perfect Pole Telescoping Handle.

Order No.	Mfg. No. / Description	List Price
460321	(SW55450)	\$19.19 F0-3431000

Swobbit Quik Dry™ Wiper Blade



- Soft medical grade silicone molds to curves and contours.
- Patented T-bar edge whisks away water in one pass.
- Safe for all finishes including paint, fiberglass, windows and enclosures.
- 14" wide blade.

Order No.	Mfg. No. / Description	List Price
460270	(SW21414)	\$31.79 F0-5222000

Swobbit Aquazorber™ Drying Mop



- Made from imported material featuring 2" wide die cut strips for maximum absorbency.
- Aquazorber mops are designed for drying decks, painted and fiberglass surfaces quickly and easily.
- Material is not affected by mold, mildew, cleaning chemicals or fuel.

Order No.	Mfg. No. / Description	List Price
460307	(SW31315)	\$62.79 F0-5934000

3M Doodlebug™ Pad Holder with Pads



- Orange plastic holder with special grippers that hold 4-5/8" x 10" 3M Doodlebug Cleaning Pads.
- Holder swivels in all directions.
- The threaded socket attaches to any standard threaded broom handle.
- Kit includes: Pad holder, (1) White Cleaning Pad and (1) Brown Scrub 'N Strip Pad.

Order No.	Mfg. No. / Description	List Price
857095	(08542)	\$57.99 F0-9504000

Swobbit Scrub Pads



- Designed to work with the Swobbit Dual-Axis Swivel Plate.
- Dimensions: 4" x 10" x 1".
- Sold 2 per pack.

Order No.	Mfg. No. / Description	List Price
460318	(SW55220) Fine Grade White	\$6.39 F0-7440000
430320	(SW55240) Corse Grade Brown	\$6.39 F0-7440000

3M Doodlebug™ Scrub Pads



- Fits 3M Doodlebug Pad Holder 6472 or 3M Doodlebug Handblock Pad Holder 6473.
- Uniform coating throughout every 3M Doodlebug pad reduces the number of knots and clumps, which eliminates scratching of floors while providing greater consistency and extended pad life.
- Pads are reversible and will not be significantly affected by water, detergents, or cleaners normally used on floor maintenance.
- Sold 5 pads per box.

WHITE CLEANING PAD - FOR CLEANING DELICATE SURFACES

Order No.	Mfg. No. / Description	List Price
857097	(08003)	\$15.69 F0-8901000

BLUE SCRUB PAD - FOR MEDIUM DUTY CLEANING AND SCRUBBING

Order No.	Mfg. No. / Description	List Price
857096	(08005)	\$15.69 F0-8901000

BROWN SCRUB 'N STRIP PAD - FOR TOUGH CLEANING & STRIPPING JOBS

Order No.	Mfg. No. / Description	List Price
857098	(08004)	\$15.69 F0-8901000

Swobbit Aqua Dry PVA Cloth



- Made from reinforced PVA material.
- 3.19 sq. ft.
- PVA absorbs 5 times its weight in liquids and is not affected by mold or mildew.
- Perfect for use in conjunction with a Quik Dry Water Blade to reduce drying time.
- Safe to use on paint, fiberglass, windows and enclosures.
- Stores in its own reusable tube.

Order No.	Mfg. No. / Description	List Price
460282	(SW38855) Size: 27" x 17"	\$13.49 F0-4490000

Swobbit Terry Micro Fiber Towels



- Clean without chemicals.
- Can be used wet or dry.
- Can be used to clean paint, fiberglass, chrome, hi-polish metals, windows and enclosures.
- Thousands of tiny fibers 1/100th the width of a human hair gently lift and remove dirt and grime without streaking or smearing.
- Towels measures 12" x 12".

Order No.	Mfg. No. / Description	List Price
460367	(SW56308) 8 Pack	\$16.39 F0-7411000

Star Brite Scrub Pads with Handle



- Durable, comfortable handle makes cleaning simple and easy.
- Pads are interchangeable.
- Handle grips onto each individual pad.

SCRUB PAD KIT WITH HANDLE

- Kit includes: (1) Handle, (1) Fine Scrub Pad, (1) Medium Scrub Pad and (1) Coarse Scrub Pad.

Order No.	Mfg. No. / Description	List Price
675890	(40023)	\$12.19 G0-7180000

INDIVIDUAL SCRUB PADS

Order No.	Mfg. No. / Description	List Price
675940	(40129) Fine Scrub Pad White	\$6.89 G0-2640000
675942	(40130) Medium Scrub Pad Red	\$6.89 G0-2640000
675944	(40131) Coarse Scrub Pad Black	\$6.89 G0-2640000

Swobbit Cotton Terry Towels



- The perfect towel for a variety of uses onboard and in the engine room including wiping, cleaning, polishing and soaking up spills.
- Extra-soft and absorbent ring spun 100% cotton makes this towel stand above the rest.
- Washable.

Order No.	Mfg. No. / Description	List Price
460364	(SW56100) 3 Pack	\$7.89 F0-2550000
460365	(SW56106) 12 Pack	\$14.79 F0-5301000

Star Brite Supersorb Synthetic PVA Wipes



- Excels at all drying tasks - absorbs up to 50% more than a natural chamois.
- Over 3 square feet.
- Unaffected by salt water.
- Leaves surface spot free.
- Long lasting, will not tear, lint or shred.
- Replaces expensive genuine chamois.

Order No.	Mfg. No. / Description	List Price
675906	(40046) Cloth Size: 27" x 17"	\$10.39 G0-6960000

- Electronics
- Trolling Motors
- Instruments
- Electrical
- Lighting
- Anchor & Dock
- Safety
- Steering, Controls
- Pumps
- Fuel System
- Seating & Pedestals
- Trailer
- Tops & Covers
- Perform.
- Propellers
- Engine & Care
- Cleaning & Care
- Paint & Paint Acc.
- Fun & Flotation
- Topside Acc.
- Cockpit & Deck
- Hardware, Fasteners
- Camouflage
- Misc.
- Comm.

Swobbit Synthetic Wash Mitt



- Plush 40 oz. synthetic material for a gentle wash.
- Oversized, holds plenty of soap & water, elastic cuff & hang tag for easy storage and drying.

Order No.	Mfg. No. / Description	List Price	
460475	(SW61850)	\$7.19	FO-3050000

Swobbit Chenille Micro Fiber Mitt



- Thousands of tiny micro fibers 1/100th the width of a human hair clean without smearing or streaking.
- Super-soft chenille micro fiber strands gently wash paint, fiberglass, windows and enclosures.
- Lined for your comfort. Elastic Cuff.
- Dimensions: 9" x 11".

Order No.	Mfg. No. / Description	List Price	
460485	(SW61865)	\$10.99	FO-9670000

Star Brite Cellulose Boat Bail Sponge

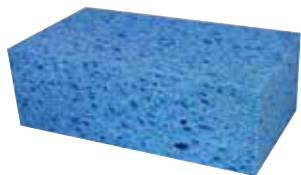

- Huge bail sponges great for soaking up any liquid.
- Absorbs over 1 quart of liquid.
- Super absorbent cellulose construction.
- Dimensions: 7-3/4" x 4-1/4" x 2-3/4".

Order No.	Mfg. No. / Description	List Price	
360595	(40075)	\$11.99	GO-3080000

Star Brite Microfiber Reggae Wash Mitt



- Microfiber material won't scratch gelcoat or painted surfaces.
- Use wet for washing, dry for dusting.
- Machine washable.

Order No.	Mfg. No. / Description	List Price	
675932	(40105)	\$9.09	GO-9060000

Star Brite Dog Bone Sponge



- Easy-grip "dog-bone" shape.
- Excellent for all washing tasks.
- Dimensions: 9" x 5" x 3-1/4".

Order No.	Mfg. No. / Description	List Price	
360593	(40074)	\$4.49	GO-1030000

Swobbit General Purpose Plastic Razor Blades



- Hot injected molded plastic razor blades designed with two sharp edges used for scraping, cleaning and peeling.
- They are non-metallic and non-magnetic so they will never rust or corrode.
- General purpose (orange blade). Softest material, very pliable and forgiving, for use on delicate surfaces.
- Package includes 5 blades and one holder.

Order No.	Mfg. No. / Description	List Price	
570716	(SR5GPOE)	\$5.79	FO-5040000

- Electronics
- Trolling Motors
- Instruments
- Electrical
- Lighting
- Anchor & Dock
- Safety
- Steering, Controls
- Pumps
- Fuel System
- Seating & Pedestals
- Trailer
- Tops & Covers
- Perform.
- Propellers
- Engine & Care
- Paint & Paint Acc.
- Fun & Flotation
- Topside Acc.
- Cockpit & Deck
- Hardware, Fasteners
- Camouflage
- Misc.
- Comm.

Marpro Epoxy Resin



- Zero V.O.C.'s.
- Formulated to be mixed at 5 parts resin to 1 part Fast or Slow Hardener.
- May be used as a laminating epoxy or thickened with Marpro fillers to a desired consistency for putty and adhesive.

Order No.	Description	List Price	
7-2510	Quart	\$18.29	F0-0821000
7-2512	.98 Gallon	\$67.09	F0-6964000
7-2514	4.35 Gallon	\$291.39	F0-7930200

Marpro Slow Epoxy Hardener



- The pot life for the slow hardener is approximately 20-25 minutes at 77° F; 15-20 minutes at 90° F and 30-35 minutes at 65° F.

Order No.	Description	List Price	
7-2528	.44 Pint Use with 7-2510	\$8.39	F0-7850000
7-2530	.84 Quart Use with 7-2512	\$19.29	F0-0531000
7-2532	.94 Gallon Use with 7-2514	\$70.19	F0-3194000

Marpro Fumed Silica Thickening Agent



- Lightweight bulking and thickening agent.
- Minimal sanding required.

Order No.	Description	List Price	
6-7578	10#	\$170.69	F0-8491100
6-7579	Quart	\$8.39	F0-7850000
7-2562	Gallon	\$21.09	F0-6741000

Marpro Fast Epoxy Hardener



- The pot life of the fast hardener is approximately 10-15 minutes at 77° F; 8-12 minutes at 90° F and approximately 20 minutes at 65° F.
- Providing low temperature cure down to 50° F.

Order No.	Description	List Price	
7-2520	.44 Pint Use with 7-2510	\$7.89	F0-2550000
7-2522	.86 Quart Use with 7-2512	\$19.29	F0-0531000
7-2524	.94 Gallon Use with 7-2514	\$72.09	F0-6405000

Marpro 2:1 Epoxy Resin



- 2:1 mix ratio is easy to measure and mix.
- Non blush formula.
- Totally clear formula with excellent wet-out properties.
- Especially good for exotic fabrics.
- Designed to cure in cooler temperatures and on damp surfaces.
- Better UV resistance.

Order No.	Description	List Price	
7-2582	Resin Gallon	\$75.49	F0-4825000
7-2586	Medium Hardener, 65° to 95° F 1/2 Gallon	\$57.29	F0-0104000

Marpro High Load Filler



- Used to build high physical strength.
- Contains Talc.

Order No.	Description	List Price	
7-2558	43 oz.	\$20.79	F0-5541000



SPECIAL HANDLING MAY APPLY



- Electronics
- Trolling Motors
- Instruments
- Electrical
- Lighting
- Anchor & Dock
- Safety
- Steering, Controls
- Pumps
- Fuel System
- Seating & Pedestals
- Trailer
- Tops & Covers
- Perform.
- Propellers
- Engine & Care
- Cleaning & Care
- Paint & Paint Acc.
- Fun & Flotation
- Topside Acc.
- Cockpit & Deck
- Hardware, Fasteners
- Camouflage
- Misc.
- Comm.

Travaco Rapid-Set Marine-Tex®



- A waterproof epoxy in a convenient 1:1 mix for emergency and permanent repairs.
- It cures in one hour at 72° F.
- This 1:1 epoxy paste provides a good bond to fill cracks and voids in fiberglass, steel, aluminum, wood, cast iron and many hard plastics.
- Formulated for quick machinery and mechanical repairs, dockside or at-sea, to get back underway with minimum downtime.
- It is also used to secure hardware and loose fasteners.

Order No.	Mfg. No. / Description	List Price
660427	(RM320K) 2 oz.	\$13.09 G0-7780000

Travaco Marine-Tex® Epoxy Putty



- A heavy duty structural epoxy, used to repair aluminum, fiberglass and wooden boats, reinstall loose or stripped fasteners, permanently bond dissimilar metals without galvanic corrosion and fill gouges in wood, metal and fiberglass, making repaired areas stronger than before.
- Resistant to water and many chemicals.
- Thick, creamy no-sag putty, easily applied.

Order No.	Mfg. No.	Color	Size	List Price
660399	(RM305K)	White	2 oz.	\$17.09 G0-5411000
660402	(RM306K)	White	14 oz.	\$47.09 G0-5513000
660414	(RM307K)	White	3 lbs.	\$121.09 G0-3118000
660363	(RM301K)	Gray	2 oz.	\$17.09 G0-5411000
660375	(RM302K)	Gray	14 oz.	\$47.09 G0-5513000
660387	(RM303K)	Gray	3 lbs.	\$121.09 G0-3118000

- Electronics
- Trolling Motors
- Instruments
- Electrical
- Lighting
- Anchor & Dock
- Safety
- Steering, Controls
- Pumps
- Fuel System
- Seating & Pedestals
- Trailer
- Tops & Covers
- Perform.
- Propellers
- Engine & Care
- Cleaning & Care
- Paint & Paint Acc.
- Fun & Flotation
- Topside Acc.
- Cockpit & Deck
- Hardware, Fasteners
- Camouflage
- Misc.
- Comm.

Star Brite Epoxy Aluminum Putty Stick



- Makes permanent and emergency repairs on aluminum boats, outdrives, fuel and water tanks and other aluminum parts.
- Easy to use; just hand knead for 1 minute and apply to damaged area.
- Can be sanded, drilled and tapped.
- Sets in 5 minutes, cures in 1 hour (cure color light gray).

Order No.	Mfg. No. / Description	List Price
431356	(87004) 4 oz.	\$18.49 G0-9321000

Star Brite Epoxy Putty Stick



- Makes permanent and emergency repairs on fiberglass, wood, metal and plastic.
- Easy to use; just hand knead until color turns white and apply to damaged area.
- Can be sanded, drilled and tapped.
- Sets in 5 minutes, cures in 1 hour (cure color off white).

Order No.	Mfg. No. / Description	List Price
431332	(87104) 4 oz.	\$18.49 G0-9321000

Devcon Plastic Steel® Putty



- Bonds to most metals, concrete and some plastics.
- Cures at room temperature and forms a tough, durable, metallic mass that can be drilled, tapped, machined or painted.
- Excellent resistance to oil, gasoline, water, and many chemicals.
- Ideal for patching and repairing areas where welding or brazing would be undesirable or impossible. Machinable to metallic finish.

Order No.	Mfg. No. / Description	List Price
273184	(230-10110) 1 lb. Kit	\$89.99 H0-9935000

Marpro Marine Putty BPO-Cured



- White, polyester based marine putty that is cured with a BPO hardener (included).
- This is a fast putty that allows the user to sand within 20 minutes of application.
- No Shrinkage.
- Approved for use below the waterline.

Order No.	Description	List Price
6-7540	Quart	\$31.19 F0-3812000

Fibreglass Evercoat Polyester Glazing Putty



- Can be applied directly to bare metal, body filler, fiberglass and fully cured sanded top coats.
- Easily fills grind marks, pinholes, low spots and other minor imperfections.
- Contains ZNX-7 for superior adhesion to galvanized steel, bare steel, aluminum, SMC, E-Coat and OEM finishes.
- No shrinkage. Easy dry. Reduces risk of staining.
- Blue cream hardener included.

Order No.	Mfg. No. / Description	List Price
431243	(100400) 20 oz.	\$43.19 F0-3203000

3M Marine Acryl-White Glazing Putty



- Putty fills minor surface imperfections.
- Easy working properties include good spreadability.
- Leaves smooth edges with quality feathering.
- Low shrinkage offers better final results.
- Slow drying formula with a 2.5 minute work time and 25 minute sanding time.

Order No.	Mfg. No. / Description	List Price
856774	(05095) 14.5 oz.	\$27.19 F0-3091000

Interlux Watertite Epoxy Filler



- A 2-part, easy to use epoxy compound for filling holes and repairing scratches in gelcoat and fiberglass above and below the waterline.
- It has a long easy-to-sand window and can be applied to a thickness of 3/4" without sagging.
- Its superior spreadability makes it an ideal glazing compound for filling small nicks and scratches.
- Area: Above or below the waterline.

Order No.	Mfg. No. / Description	List Price	
404309	(YAV135KIT500) 16.9 oz.	\$35.69	E0-7762000
404323	(YAV135KIT/L) Liter	\$59.39	E0-4544000

Pettit EZ-Tex Marine Epoxy Repair Compound



- Easy to use 1:1 mix ratio repair compound for cracks, gouges, voids and holes.
- High strength formula makes repairs permanent.
- 100% waterproof when cured.
- Will not sag, shrink or run.
- Can be sanded, drilled, tapped, sawed and painted once cured.

Order No.	Mfg. No. / Description	List Price	
735736	(7100/4) 4 oz.	\$13.79	E0-4301000

3M Marine Premium Filler



- Use for filling and fairing of fiberglass, wood, aluminum and steel surfaces.
- Cures fast - sandable in 30 minutes.
- Use for hulls, decks and other parts.
- Easy to sand, contains 3M Glass Bubbles.
- Includes 3M Cream Hardener (1 oz.).

Order No.	Mfg. No. / Description	List Price	
852499	(46004) Pint	\$36.09	F0-6252000
852500	(46005) Quart	\$70.99	F0-9694000
852512	(46006) Gallon	\$210.99	F0-9674100

3M Marine Cream Hardener



- Easy mixing produces a quality hardener blend.
- Designed for use with 3M 2-part body filler and glazes.
- 2.75 oz.

Order No.	Mfg. No. / Description	List Price	
856736	(05830) Red	\$6.39	F0-7440000
856748	(05766) Blue	\$6.49	F0-4540000

Pettit Splash Zone 2-Part Epoxy Compound



- An extremely hard, abrasion and impact resistant, two-part epoxy patching compound.
- It applies like putty to seal, fill, patch or re-build aluminum, wood, concrete, fiberglass and steel.
- It can be applied in or out of water to repair boat hulls, buoys, seawalls, docks, bridge abutments and more.
- Provides excellent protection against corrosion of metals and erosion and deterioration of concrete or wood.
- Not for use in potable water.

Order No.	Mfg. No. / Description	List Price	
735734	(A-788QT) Quart	\$54.39	E0-9704000
735728	(A-788HGS) 1/2 Gallon	\$101.69	E0-7267000
735722	(A-788-2GL) 2 Gallon	\$233.79	E0-4357100

3M Marine Lightweight Body Filler



- Creamy formula provides easy mixing and spreading.
- Good handling properties. Tack-free finish.
- Vacuum processed formula minimizes pinholes.
- Two-component system includes filler and hardener.
- Repairs dents, dings and other cosmetic imperfections on bare steel, aluminum and fiberglass reinforced polyester.

Order No.	Mfg. No. / Description	List Price	
856724	(05801) Gallon	\$38.19	F0-3762000

3M Marine High Strength Repair Filler



- Filler restores damaged fiberglass hulls and decks on boats.
- Short strands of fiberglass reinforce strength of filler.
- Paste consistency allows application of vertical surfaces.
- Non-staining and non-shrinking formula.
- Includes 3M Cream Hardener (1 oz.).

Order No.	Mfg. No. / Description	List Price	
852548	(46013) Quart	\$100.59	F0-1407000
852550	(46014) Gallon	\$238.49	F0-4966100

Gator Guards Gator Patch

- UV cure fiberglass reinforced repair patch.
- Watertight, impenetrable.
- A prep-peel-stick application that cures simply with UV light in under an hour.
- Will bond to virtually all materials.
- Repairs almost any surface, moldable around flat or curved areas, dents, joints or angles.
- Can be drilled, tapped, sanded or painted within hour.



Order No.	Mfg. No. / Description	List Price	
2487860	(GP36) White, 3" x 6"	\$17.19	F0-3021000



SPECIAL HANDLING MAY APPLY



- Electronics
- Trolling Motors
- Instruments
- Electrical
- Lighting
- Anchor & Dock
- Safety
- Steering, Controls
- Pumps
- Fuel System
- Seating & Pedestals
- Trailer
- Tops & Covers
- Perform.
- Propellers
- Engine & Care
- Cleaning & Care
- Paint & Paint Acc.
- Fun & Flotation
- Topside Acc.
- Cockpit & Deck
- Hardware, Fasteners
- Camouflage
- Misc.
- Comm.



Fibreglass Evercoat Formula 27 Plastic Filler

EVERCOAT

- Permanent repair of fiberglass, wood, metal, stucco and drywall.
- High quality, white plastic filler for filling dents, scrapes and gouges.
- Does not shrink after curing.
- Can be tinted with Coloring Agents.
- White cream hardener included.



Order No.	Mfg. No. / Description	List Price	
431255	(100572) 1/2 Pint	\$15.29	FO-0701000
431267	(100571) Pint	\$24.79	FO-5371000
431279	(100570) Quart	\$35.09	FO-6542000

Polyester Resin Fibreglass Repair Kits

EVERCOAT



- Fast and easy permanent repairs of fiberglass, most woods and metals.
- May be used for small lay-up jobs or fabricating missing fiberglass panels.
- Includes: 1/2 pint of polyester resin with hardener, 3 sq. ft. of fiberglass cloth, spreader stick, mixing tray and instructions.

Order No.	Mfg. No. / Description	List Price	
431231	(100637) 1/2 Pint Kit	\$35.89	FO-2152000

Marpro Table Top Epoxy Resin



- Self leveling, clear formula.
- Formulated for a one to one mix ratio.
- Designed for interior wood depth coat finishing.
- Apply up to 1/8" deep per coat.
- For use in temps above 75° F.
- 45 minute pot life.

Order No.	Description	List Price	
6-7530	Quart Kit	\$26.99	FO-9881000
6-7531	Gallon Kit	\$58.19	FO-3704000

Marpro High Quality Vinylester Resin



- For use in boat construction where the highest strength water intrusion resistance is required.
- May be used in some vacuum infusion applications.
- Contains no wax.
- Has shelf life restrictions.

Order No.	Description	List Price	
6-7506	Gallon	\$76.59	FO-1635000
6-7507	5 Gallon	\$369.49	FO-4685200

Marpro Premium Resin with Wax



- No shrinkage.
- Tack free finish.
- Cannot be coated with gel coat or paint.
- Hardener included.

Order No.	Description	List Price	
6-7514	Gallon	\$37.59	FO-1362000

Travaco Gluvit™ Waterproof Epoxy Sealer



- Gluvit barrier coat seals and protects hulls and decks.
- Provides superior protection for fiberglass, wood, aluminum and steel.
- Seals leaky seams and rivets in aluminum hulls and leaks around fiberglass cabins or decks.
- Hard protective coating flexes with hull movements to bridge and seal hairline cracks.

Order No.	Description	List Price	
660426	Quart	\$62.19	G0-7614000
660438	Gallon	\$160.99	G0-6870100

Star Brite 5 Minute Cure Epoxy Syringe - Clear



- Convenient self-metering syringe applicator.
- Bonds fiberglass, rubber, hard plastic, glass, fabric, ceramic and metal.
- Fills cracks and holes, mounts components, seals seams.
- Resists most liquids.
- Crystal clear appearance after curing.
- Permanent strength up to 1,200 PSI.

Order No.	Mfg. No. / Description	List Price	
999146	(93401) 1 oz.	\$9.09	G0-9060000

Marpro Premium Resin - No Wax



- A polyester resin specially formulated to create a hard film in a minimum of time.
- Can be re-laminated up to six months from initial layup with no sanding.
- Contains no wax.
- Has an extended shelf life.
- Hardener included.

Order No.	Description	List Price	
6-7410	Quart	\$13.39	FO-7390000
6-7411	Gallon	\$38.59	FO-1072000
6-7412	5 Gallon	\$171.69	FO-8102100

SPECIAL HANDLING MAY APPLY

- Electronics
- Trolling Motors
- Instruments
- Electrical
- Lighting
- Anchor & Dock
- Safety
- Steering, Controls
- Pumps
- Fuel System
- Seating & Pedestals
- Trailering
- Tops & Covers
- Perform.
- Propellers
- Engine & Care
- Paint & Paint Acc.
- Fun & Flotation
- Topside Acc.
- Cockpit & Deck
- Hardware, Fasteners
- Camouflage
- Misc.
- Comm.

Marpro Gel Coat



- Exterior gel coat is pigmented with Titanium Dioxide.
- It is resilient (will withstand good impact) and it is light stabilized.
- Designed for mold operation, a wax solution must be added when using for repairs to provide sandability.

GEL COAT - NO WAX

Order No.	Description	List Price	
6-7623	Neutral for Tint Base, Quart	\$20.49	FO-4341000
6-7625	White, Quart	\$18.39	FO-7821000
6-7626	White, Gallon	\$64.09	FO-6844000

GEL COAT WITH WAX

Order No.	Description	List Price	
6-7621	Quart	\$18.99	FO-9231000
6-7622	Gallon	\$67.89	FO-2574000

WEBBING SOLUTION

- Used to create a splatter or spider web effect with gel coat of one color and sprayed on another.

Order No.	Description	List Price	
6-7634	Pint	\$17.69	FO-8321000

Marpro Milled Fibers



- Used to thicken polyester and epoxy resins.

Order No.	Description	List Price	
6-7570	Quart	\$14.49	FO-4101000

Marpro Styrene



- Resin and gel coat thinner.
- Use up to 10% with polyester resin.
- Use up to 5% with gel coat.

Order No.	Description	List Price	
6-7475	4 oz.	\$5.89	FO-2140000
6-7620	Pint	\$10.49	FO-4370000

Marpro M.E.K.P.



- A Methyl-ethyl ketone peroxide liquid hardener catalyst for all polyester resins, vinylester resins and gel coats.

Order No.	Size	For	List Price	
6-7500	1/4 oz.	Quart	\$1.99	FO-9310000
6-7501	1 oz.	Gallon	\$3.19	FO-3220000
6-7502	Pint	5 Gallon	\$11.49	FO-4080000
6-7503	Gallon	55 Gallon	\$56.29	FO-0493000
7-2580	M.E.K.P. Dispenser		\$8.69	FO-8060000

Marpro Micro Balloons



- Use for thickening epoxy and polyester resins.
- Larger particle size, used for fairing compounds and putty.

Order No.	Description	List Price	
6-7575	Quart	\$18.79	FO-5131000
6-7576	Gallon	\$38.59	FO-1072000

Marpro Wax Sol



- Add to gel coat that does not contain wax to produce a tack free finish.

Order No.	Description	List Price	
6-7630	4 oz. For Gallon	\$6.79	FO-5740000

- Electronics
- Trolling Motors
- Instruments
- Electrical
- Lighting
- Anchor & Dock
- Safety
- Steering, Controls
- Pumps
- Fuel System
- Seating & Pedestals
- Trailer
- Tops & Covers
- Perform.
- Propellers
- Engine & Care
- Cleaning & Care
- Paint & Paint Acc.
- Fun & Flotation
- Topside Acc.
- Cockpit & Deck
- Hardware, Fasteners
- Camouflage
- Misc.
- Comm.



SPECIAL HANDLING MAY APPLY



Fibreglass Evercoat Gelcoat Repair Kit



- Permanently repair nicks, gouges and scratches in fiberglass hulls and decks.
- Blend coloring agents to achieve a match to almost any color.
- Repair material cures glass-hard in one hour.
- A special release film and no-run polyester gel makes a slick, no-sand finish quick and easy.
- Repair kit includes: Polyester gelcoat paste (1 fl. oz.), liquid hardener (.25 fl. oz.), 6 color agents (.25 fl. oz.), 2 stir sticks, special release film, color guide, sandpaper 4.5" x 5.5", color matching guide and instructions.

Order No.	Mfg. No. / Description	List Price
440064	(108000)	\$46.39 FO-7423000

Marpro Coloring Agents



- Popular color matching agents that blend with polyester resins, gel paste and epoxy resins, Formula 27 and various putties.
- Use 1 oz. color per quart of resin.
- Colorants may be mixed to obtain desired color match.
- Use very small amounts to tint fiberglass repair putty or scratch patch.

Order No.	Description	List Price
6-7544	Green 1 oz.	\$8.99 FO-9260000
6-7545	Red 1 oz.	\$8.99 FO-9260000
6-7546	Gold 1 oz.	\$8.99 FO-9260000
6-7547	Brown 1 oz.	\$8.99 FO-9260000
6-7548	Blue 1 oz.	\$8.99 FO-9260000
6-7549	Black 1 oz.	\$8.99 FO-9260000
6-7550	White 1 oz.	\$8.99 FO-9260000
6-7551	White 4 oz.	\$18.69 FO-8031000

Marpro Resin Rollers

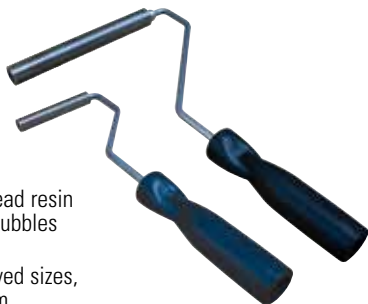

- Spiral threaded grooves to spread resin and glass better, removes air bubbles and laminates evenly.
- Features: Angled tapered grooved sizes, contoured angles and aluminum.

Order No.	Description	List Price
6-7640	Dimensions: 1/2" x 3"	\$15.39 FO-7701000
6-7641	Dimensions: 3/4" x 6"	\$19.39 FO-7531000

Fibreglass Evercoat Spreader Kit



- Flexible plastic spreader for fast, clean application of body fillers and putties.

Order No.	Mfg. No. / Description	List Price
431217	(100381) Pack of 3	\$5.09 FO-6530000
440836	(101018) 5" Yellow Spreader	\$1.39 HO-3800000

Fibreglass Evercoat Gelcoat Scratch Patch



- Repair fiberglass boats.
- Easy permanent repairs on hairline cracks, small scratches and chips in fiberglass.
- This one part formula does not need a catalyst.
- Just fill in the crack, let it set and scrape off the excess with the enclosed spreader.
- Ideal for surface scratch repairs of metal flake finish.

Order No.	Mfg. No. / Description	List Price
439984	(105652) White 1/2 fl. oz.	\$14.59 FO-1201000
439996	(105653) Buff White 1/2 fl. oz.	\$14.59 FO-1201000

MagicEzy Mega Fusion Primer/Sealant



- Used to prime plastic and aluminum before an application of Magic Ezy 9 Second Chip Fix or Hairline Fix.
- Very strong adhesion. Strengthens weakened surfaces. Highly flexible. Built in leveling device. Water clean-up. Non-hazardous.
- Use on plastic, aluminum and fiberglass.

Order No.	Mfg. No. / Description	List Price
440113	(321410) .43 fl. oz.	\$21.89 HO-3131000

Boat Life "Git"-Rot Kit



- A two-part liquid epoxy saturates and restores original strength to wood by penetrating the rot.
- Cures overnight.
- Sandable and paintable, can be drilled and screwed.
- Compatible with fiberglass resin, epoxies and most sealants.

Order No.	Mfg. No. / Description	List Price
248775	(1063) 4 oz.	\$20.99 GO-6041000
248787	(1064) Pint	\$47.89 GO-9023000
248788	(1065) Quart	\$80.79 GO-3145000

3M Marine Spreader



- Designed for spreading body and fiberglass fillers, finishing putties and resins.
- Have sharp edges, are flexible, durable, easy to clean and cured filler pops off easily.
- Sold each.

Order No.	Mfg. No. / Description	List Price
2012218	(05842) Size: 4"	\$1.29 FO-0900000

Hawk Epoxy Resin



- A premium blend, low odor epoxy resin used for general fiberglass repair and construction for superior adhesion, strength, bonding, filling and moisture barrier.
- Must be used in combination with desired Hawk Epoxy Catalyst.
- May be combined with Hawk Epoxy fillers or thickeners for a variety of applications and desired effects.

Order No.	Mfg. No. / Description	List Price
611022	(R1-S2) Size 2 ■ Gallon	\$75.69 F0-8925000
611044	(R1-S4) Size 4 ■ 52.03 Gallon Drum	\$2,995.49 F0-4869020

Hawk Slow Cure Catalyst

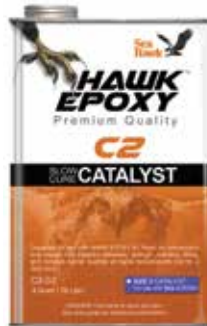

- Designed for use with HAWK EPOXY R1 Resin for high-strength bonding, coating and fiberglass applications with excellent moisture barrier characteristics when a slower cure speed is required and during high temperatures.
- Do not use under Sea Hawk marine wood varnish.
- Pot life (6 oz. at 77° F): 20-25 minutes.

Order No.	Mfg. No. / Description	List Price
611574	(C2-S2) Size 2 ■ .8 Quart	\$34.99 F0-9442000
611598	(C2-S4) Size 4 ■ 10.4 Gallons	\$1,311.79 F0-5281900

Hawk Clear Finish Catalyst



- Designed for use with HAWK EPOXY R1 Resin for very clear fiberglass cloth and coating applications with exceptional moisture barrier characteristics.
- Perfect for natural wood and carbon fiber clear coats with no blush.
- Longer working times in very warm temperatures.
- May be used under Sea Hawk marine wood varnish.
- Pot life (4 oz. at 77° F): 22-27 minutes.

Order No.	Mfg. No. / Description	List Price
611764	(C5-S2) Size 2 ■ .33 Gallon	\$64.39 F0-7054000
611788	(C5-S4) Size 4 ■ 17.33 Gallons	\$2,313.19 F0-3291610

Hawk Ultra Slow Cure Catalyst



- Designed for use with HAWK EPOXY R1 Resin for construction and repairs with superior adhesion, strength, bonding, filling and moisture barrier qualities at higher temperatures and for an ultra slow cure.
- Do not use under Sea Hawk marine wood varnish.
- Pot life (4 oz. at 77° F): 40-50 minutes.

Order No.	Mfg. No. / Description	List Price
611512	(C1-S2) Size 2 ■ .33 Gallon	\$59.39 F0-7514000
611536	(C1-S4) Size 4 ■ 17.33 Gallons	\$1,997.69 F0-8389310

Hawk Fast Cure Catalyst



- Designed for use with HAWK EPOXY R1 Resin for construction and repairs with superior adhesion, strength, filling and moisture barrier qualities at cooler temperatures and for a fast cure speed at room temperatures.
- Do not use under Sea Hawk marine wood varnish.
- Pot life (6 oz. at 77° F): 9-12 minutes.

Order No.	Mfg. No. / Description	List Price
611651	(C3-S2) Size 2 ■ .8 Quart	\$34.99 F0-9442000
611675	(C3-S4) Size 4 ■ 10.4 Gallons	\$1,311.79 F0-5281900

Hawk Epoxy Pump Kits

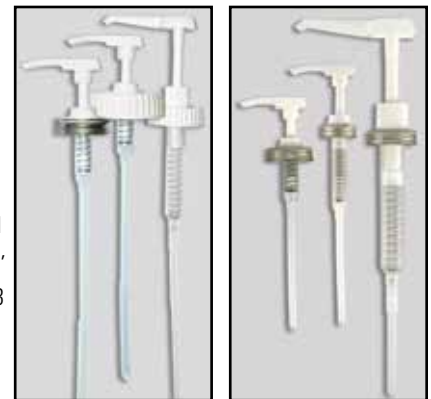

- For accurately measuring Resin to Catalyst ratio.
- Two sizes, one kit accommodating the Size 1 and 2 Resin and Catalysts, and one kit accommodating the Size 3 Resin and Catalysts.
- Contains one R1 Resin pump, one C2 & C3 Catalyst pump and one C1 & C5 Catalyst pump.

Order No.	Mfg. No. / Description	List Price
612627	(30-KT-S3) For use with Size 3 ■	\$15.19 F0-3601000

Hawk Epoxy's Color-Coded System Sizing Ensures Accuracy

Hawk Epoxy Size 3

Hawk Epoxy Size 4

- Hawk Epoxy is available in four System Sizes which are color-coded on each resin and catalyst label.
- Mix ratios vary depending on which catalyst is being used. For optimal product utilization, be sure to choose the same System Size for both the resin and catalyst. Any of the six fillers can be used with any combination of Hawk Epoxy Resin and Catalysts, giving you an incredibly large range of epoxy blends, all within this one system



SPECIAL HANDLING MAY APPLY



- Electronics
- Trolling Motors
- Instruments
- Electrical
- Lighting
- Anchor & Dock
- Safety
- Steering, Controls
- Pumps
- Fuel System
- Seating & Pedestals
- Trailering
- Tops & Covers
- Perform.
- Propellers
- Engine & Care
- Cleaning & Care
- Paint & Paint Acc.
- Fun & Flotation
- Topside Acc.
- Cockpit & Deck
- Hardware, Fasteners
- Camouflage
- Misc.
- Comm.

Hawk High Load Adhesive Fiber Filler



- Thickens to a light grey color creating an easy to use adhesive designed for bonding hardware and other applications with dissimilar materials.
- This mixture will maximize bond strength for anticipated high loads.

Order No.	Mfg. No. / Description	List Price	
612123	(F1-L) Size Large	\$220.59	F0-1445100
612110	(F1-M) Size Medium 43.5 oz.	\$27.49	F0-4291000
612107	(F1-S) Size Small 15.2 oz.	\$10.49	F0-4370000

Hawk Structural Adhesive Filler



- Thickens to an off white color, creating a general purpose thickening additive for bonding, gap filling and filleting.
- Mix to a workable consistency allowing sag-free and easy flow properties for vertical and overhead applications.

Order No.	Mfg. No. / Description	List Price	
612184	(F2-XL) Size X Large 22 lbs.	\$335.79	F0-5053200
612173	(F2-L) Size Large 10 lbs.	\$228.29	F0-0895100
612160	(F2-M) Size Medium 4.9 oz.	\$21.59	F0-1151000
612154	(F2-S) Size Small 1.7 oz.	\$8.09	F0-6650000

Hawk Light Density Adhesive Micro Fiber Filler



- Thickens to an off white color.
- Great for bonding many substrates, especially wood.
- The mixture also creates a multipurpose adhesive for many other substrates in addition to providing excellent substrate wetting and penetrating characteristics.
- Increases impact and abrasion resistance.

Order No.	Mfg. No. / Description	List Price	
612236	(F3-L) Size Large 20 lbs.	\$203.19	F0-3224100
612223	(F3-M) Size Medium 17.2 oz.	\$20.89	F0-2641000
612212	(F3-S) Size Small 6 oz.	\$7.99	F0-9550000

Hawk Bridging Adhesive Filler



- Thickens to a brown color, creating an easy to use adhesive with excellent gap filling and filleting qualities.
- This mixture blends with many different types of wood to allow for a natural looking fillet or gap fill.

Order No.	Mfg. No. / Description	List Price	
612261	(F4-S) Size Small 5.6 oz.	\$14.89	F0-2401000

Hawk Light Density Fairing Filler



- Thickens to a reddish brown color, achieving an easy to sand and carve fairing compound while still remaining strong and light weight.

Order No.	Mfg. No. / Description	List Price	
612325	(F5-L) Size Large 14 lbs.	\$411.79	F0-5288200
612312	(F5-M) Size Medium 11.4 oz.	\$32.29	F0-0622000
612309	(F5-S) Size Small 4 oz.	\$12.29	F0-0680000

Hawk MicroSphere Fairing Filler



- Thickens to a white color, creating a lightweight fairing compound for small to large areas.
- This product holds a feathered edge very well and is suitable for nearly every substrate.
- This closed celled structure can also be used for increased acoustic and thermal insulation.

Order No.	Mfg. No. / Description	List Price	
612387	(F6-L) Size Large 4 lbs.	\$266.79	F0-5768100
612374	(F6-M) Size Medium 14.9 oz.	\$26.29	F0-0481000
612365	(F6-S) Size Small 5.2 oz.	\$11.69	F0-8180000

Hawk Epoxy Filler Selection Guide

Filler Suitability:

- Best: 🦅🦅🦅🦅🦅
- Better: 🦅🦅🦅🦅
- Good: 🦅🦅🦅
- Do Not Use: No Claw

MORE STRENGTH ← Harder to Sand Easier to Sand → LESS STRENGTH

Use	F1	F2	F3	F4	F5	F6
Bonding Hardware	🦅🦅🦅🦅🦅	🦅🦅🦅🦅🦅	🦅🦅🦅🦅	🦅🦅🦅		
General Bonding	🦅🦅🦅🦅	🦅🦅🦅🦅	🦅🦅🦅	🦅🦅		
Bonding with fillets	🦅🦅🦅	🦅🦅🦅	🦅🦅	🦅	🦅🦅🦅	
Laminating	🦅🦅🦅	🦅🦅🦅	🦅🦅🦅	🦅🦅	🦅🦅	
Fairing					🦅🦅🦅	🦅🦅🦅

Taco Marine KingStarboard® Polymer Sheets



- High density, UV-stabilized polyethylene.
- These polymer sheets are environmentally stabilized to withstand the harshest marine conditions.
- These sheets will not warp, rot or delaminate when exposed to humidity or water.
- Individually wrapped.

Order No.	Mfg. No.	L x W	Thick	Color	List Price	
840515	(P10-2506WHA1)	12" x 6"	1/4"	White	\$11.79	F0-5280000
840520	(P10-2512WHA1)	12" x 12"	1/4"	White	\$17.59	F0-1321000
840505	(P102512WHA27)	12" x 27"	1/4"	White	\$27.99	F0-9591000
840002	(P105012WHA27)	12" x 27"	1/2"	White	\$48.89	F0-2243000
840303	(P105012BLK27)	12" x 27"	1/2"	Black	\$48.89	F0-2243000
840307	(P105012SFM27)	12" x 27"	1/2"	Seafoam	\$50.29	F0-0253000
840208	(P107512WHA27)	12" x 27"	3/4"	White	\$73.99	F0-9715000
840510	(P102524WHA27)	24" x 27"	1/4"	White	\$50.09	F0-6053000
840005	(P105024WHA27)	24" x 27"	1/2"	White	\$92.39	F0-7646000
840010	(P105024WHA54)	24" x 54"	1/2"	White	\$167.99	F0-9571100

Coosa Composite Panels



- A high density, closed-cell polyurethane foam reinforced with woven roving and continuous strand fiberglass.

BLUEWATER 26 - DENSITY OF 26 POUNDS PER CUBIC FOOT

- Coosa's strongest and stiffest panel. Ultimate high strength-to-weight ratio. Typically used as a structural component. 30% or more lighter than plywood.

Order No.	Mfg. No. / Description	Dimensions:	List Price	
412142	(PBW0050T) 1/2"	4' x 8'	\$359.89	F0-2915200
412154	(PBW0625T) 5/8"	4' x 8'	\$366.49	F0-4565200
412166	(PBW0075T) 3/4"	4' x 8'	\$378.89	F0-2256200
412196	(BW26 1-1/2") 1-1/2"	4' x 8'	\$683.89	F0-2787400

BLUEWATER 20 - DENSITY OF 20 POUNDS PER CUBIC FOOT

- Coosa's economical alternative. Typically used as a semi-structural component. 45% or more lighter than plywood.

Order No.	Mfg. No. / Description	Dimensions:	List Price	
412192	(B20W0050T) 1/2"	4' x 8'	\$260.39	F0-7228100

Taco Marine KingStarboard® Anti Skid



- High density, UV-stabilized polyethylene.
- Special high friction surface in a diamond pattern finish prevents slipping and promotes drainage when wet.
- Saltwater resistant.
- Developed to withstand the harshest marine conditions.
- Passes ASTM D2047 slip resistant testing.
- Resists most stains and does not change color.
- Does not rot or delaminate.
- Does not need refinishing.
- Chemical resistant.
- Cleans easily with marine-grade soaps or cleaners using fresh water.

Order No.	Mfg. No.	L x W	Thick	Color	List Price	
840525	(P14-5012WHA2)	12" x 27"	1/2"	White	\$54.29	F0-0083000
840530	(P14-7512WHA2)	12" x 27"	3/4"	White	\$79.69	F0-8755000

King Starboard® Polymer Sheet



- Made of the finest polymers available, using King's proprietary K-Stran process for superior flatness and consistency.
- Environmentally stabilized for harsh sun and tough marine environments.
- Will not rot, swell, splinter or delaminate when exposed to humidity or water.
- Precise tolerances ensure consistent color, thickness and density, even for special thickness gauges and custom order colors.
- Easy to fabricate with standard woodworking tools and requires little or no finishing.
- Durable matte-textured surface on both sides.
- Easy to clean and never needs refinishing.
- Edges finish cleanly and easily.
- Forms easily for smooth curves.
- Has passed the Federal Motor Vehicle Standard 302 fire test required for use in motor vehicles, including motor homes.
- Shipped with a protective masking on one side.
- Proven on thousands of boats and yachts.
- Experienced boat builders and boaters know the King StarBoard brand and trust it more than any other.

Order No.	Mfg. No.	Dimensions:	Color	List Price	
242400	(1/4WW)	1/4" x 54" x 48"	White	\$110.89	F0-2677000
242410	(3/8WW)	3/8" x 54" x 48"	White	\$161.49	F0-4031100
242420	(1/2WW)	1/2" x 54" x 48"	White	\$214.59	F0-1205100
242430	(3/4WW)	3/4" x 54" x 48"	White	\$322.69	F0-8852200
242440	(1/4WW-96)	1/4" x 54" x 96"	White	\$221.69	F0-8155100
242450	(3/8WW-96)	3/8" x 54" x 96"	White	\$322.99	F0-9062200
242460	(1/2WW-96)	1/2" x 54" x 96"	White	\$429.19	F0-3400300

Electronics

Trolling Motors

Instruments

Electrical

Lighting

Anchor & Dock

Safety

Steering, Controls

Pumps

Fuel System

Seating & Pedestals

Trailering

Tops & Covers

Perform.

Propellers

Engine & Care

Cleaning & Care

Paint & Paint Acc.

Fun & Flotation

Topside Acc.

Cockpit & Deck

Hardware, Fasteners

Camouflage

Misc.

Comm.



SPECIAL HANDLING MAY APPLY



Marpro Fiberglass Cloth Tape

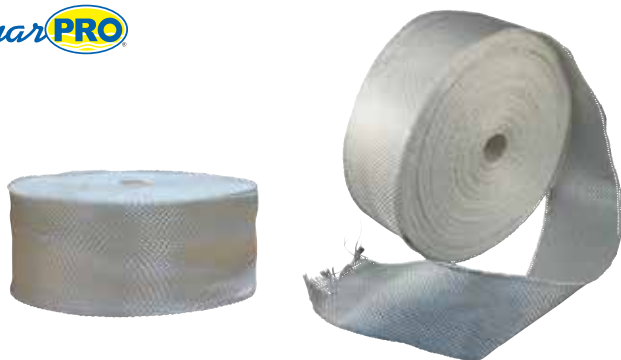

- The finest quality fiberglass cloth woven in narrow widths with non-raveling edges.

Order No.	Description	List Price	
6-7610	2" x 50 yds.	\$27.39	FO-7191000
6-7611	4" x 50 yds.	\$54.19	FO-3973000
6-7612	6" x 50 yds.	\$80.79	FO-5565000
6-7613	12" x 50 yds.	\$146.79	FO-5720100

Marpro Fiberglass Matting



- 100% fiberglass in a non-woven state.
- Use as reinforcement for polyester or epoxy resin.
- Finishing mat.

Order No.	Description	List Price	
6-7600	1.5 oz. 38" x 1 yd.	\$7.29	FO-0150000
6-7601	1.5 oz. 38" x 3 yds.	\$19.29	FO-0531000
6-7603	1.5 oz. 50" x 1 yd.	\$8.59	FO-1060000
6-7604	1.5 oz. 50" x 3 yds.	\$25.59	FO-1971000
6-7605	1.5 oz. 50" x 73 lineal yds.	\$284.79	FO-5399100

Marpro Fiberglass Cloth



- The finest quality 7-1/2 oz. fiberglass cloth.
- Available for use with polyester & epoxy resins and gel coats.

Order No.	Description	List Price	
6-7590	38" x 1 yd.	\$8.39	FO-7850000
6-7591	38" x 3 yds.	\$22.79	FO-5951000
6-7592	50" x 1 yd.	\$15.69	FO-8901000
6-7593	50" x 3 yds.	\$41.19	FO-3882000
6-7585	38" x 60 yds.	\$337.29	FO-0163200
6-7586	50" x 60 lineal yds.	\$680.29	FO-0267400

Marpro Fiberglass Woven Roving



- Heavy weight fiberglass fabric.
- Very bulky for stronger repair applications where large build-up is needed.

Order No.	Description	List Price	
6-7595	24 oz. 38" x 1 yd.	\$10.39	FO-7270000

Marpro Combination Mats



- Mat and woven roving combination.

24 OZ. WOVEN STITCHED TO 1/2 OZ. CHOPPED STRAND MAT			
Order No.	Description	List Price	
6-7608	50" x 1 yd.	\$22.99	FO-9061000
6-7606	50" Roll	\$320.59	FO-1442200

Marpro Biaxial Combination Mats



- Mat and woven roving combination.

17 OZ. WOVEN STITCHED TO 1/2 OZ. CHOPPED STRAND MAT			
Order No.	Description	List Price	
6-7594	50" x 1 yd.	\$20.79	FO-5541000
6-7588	6" x 50 yds.	\$90.19	FO-3136000
6-7589	12" x 50 yds.	\$196.79	FO-5773100
6-7587	50" Roll	\$318.29	FO-0822200

SPECIAL HANDLING MAY APPLY

Marpro Acetone



- Premium grade quality, 100% virgin acetone.
- A colorless, clear, fast drying solvent used extensively for cleaning brushes, rollers, as a degreaser, cleaner in fiberglass fabrication and formulations for removing paint, lacquer and varnish.

Order No.	Description	List Price	
6-7450	Quart	\$6.79	F0-5740000
6-7454	Gallon (Single)	\$25.39	F0-7771000
6-7451	Gallon (Case of 4)	\$18.39	F0-7821000
6-7452	5 Gallon	\$81.19	F0-3865000
6-7453	55 Gallon	\$623.99	F0-9763400

Marpro Lacquer Thinner



- Thins and cleans more effectively than mineral spirits.
- Used to help control brushing and spraying consistency.
- Not for use on nylon or synthetic tools.
- May be used as a cleaner for spray equipment, brushes and rollers.

Order No.	Description	List Price	
6-7468	Gallon (Single)	\$27.79	F0-5491000
6-7467	5 Gallon	\$82.79	F0-5975000

Marpro Mineral Spirits



- Good brush cleaning solvent.
- Low odor, quick drying.
- May be added to oil base paints, enamels & varnishes for exterior and interior use to thin and control flow rate.
- Do not use with synthetic or rubber base enamels or water thinned paints.

Order No.	Description	List Price	
6-7470	Quart	\$6.49	F0-4540000
6-7471	Gallon	\$15.89	F0-2111000

Marpro M.E.K. Solvent



- An active ketone solvent for cleaning and dissolving epoxy and polyester resins and caulks.
- Slower evaporating than acetone.

Order No.	Description	List Price	
6-7456	Quart	\$8.99	F0-9260000
6-7458	Gallon (Single)	\$37.29	F0-0162000
6-7457	Gallon (Case of 4)	\$30.19	F0-3112000

Marpro Denatured Alcohol



- An excellent fuel for alcohol burning stoves and lamps.
- Burns with a clear colorless flame.

Order No.	Description	List Price	
6-7463	Gallon (Single)	\$24.59	F0-1271000
6-7462	5 Gallon	\$81.19	F0-3865000

Marpro Parts Washer Solution



- Low odor, quick drying, crystal clear formula.
- Effectively removes dirt, grease & grime.
- Excellent for areas where low flash point solutions can't be used.
- Good for cleaning parts, brushes and rollers.

Order No.	Description	List Price	
6-7405	Gallon	\$15.89	F0-2111000
6-7407	5 Gallon	\$71.49	F0-4005000

Marpro Xylene



- Use for paint thinning and brush cleaning.

Order No.	Description	List Price	
6-7473	Gallon	\$19.29	F0-0531000

3M General Purpose Adhesive Cleaner



- A specially blended solvent which provides easy cleanup of most types of adhesives, bugs, greases and oils, overspray, silicone, waxes and tars.

Order No.	Mfg. No. / Description	List Price	
856541	(08984) Quart	\$24.09	F0-6861000

3M Specialty Adhesive Remover



- This VOC-compliant (70%) solvent-based liquid specialty adhesive remover is designed to remove reactive from a variety of substrates.
- Reactive adhesives include adhesives that require a hardener or catalyst in order for the bond to occur.
- Examples of reactive adhesives include, but are not limited to: Epoxies, urethanes, silicones.

Order No.	Mfg. No. / Description	List Price	
856536	(38984) Quart	\$37.69	F0-8362000



SPECIAL HANDLING MAY APPLY



- Electronics
- Trolling Motors
- Instruments
- Electrical
- Lighting
- Anchor & Dock
- Safety
- Steering, Controls
- Pumps
- Fuel System
- Seating & Pedestals
- Trailering
- Tops & Covers
- Perform.
- Propellers
- Engine & Care
- Cleaning & Care
- Paint & Paint Acc.
- Fun & Flotation
- Topside Acc.
- Cockpit & Deck
- Hardware, Fasteners
- Camouflage
- Misc.
- Comm.

Marpro Epoxy Glue



- High viscosity.
- 1 to 1 mix ratio.
- 45 minute pot life; sandable in 4 hrs.
- Excellent bonding to properly prepared surfaces.

Order No.	Description	List Price
6-7520	Pint Set	\$18.99 F0-9231000
6-7521	Quart Set	\$32.79 F0-5922000
6-7522	Gallon Set	\$103.99 F0-9727000

3M Marine Neoprene Contact Adhesive



- A brushable, light yellow colored contact adhesive.
- Air drying contact adhesive which bonds immediately and permanently upon application of contact pressure - no clamping or fixturing.
- It bonds many decorative and high pressure laminates, plastic, aluminum, steel, particle board, wood, masonry, rubber and canvas.

Order No.	Mfg. No. / Description	List Price
856538	(20272) Quart	\$44.89 F0-2413000

Permatex Super Glue Gel



- This no run gel formula "stays put" for precise application on hard-to-reach, overhead or even on vertical surfaces.
- This permanent, transparent bond is easily applied and works on both porous and nonporous materials including metal, rubber, glass, aluminum, vinyl, ceramics, alloys and plastics.
- Fills gaps to .004".
- Suggested applications: For vertical surfaces where regular adhesive runs. Metal, plastics, rubber, leather, vinyl, paper, wood, textiles and cork gaskets.

Order No.	Mfg. No. / Description	List Price
545179	(82191) .07 oz. Tube	\$3.09 H0-5810000

Permatex Cold Weld Bonding Compound



- A 15-minute, two-part adhesive and filler system that eliminates the need for welding or brazing.
- It repairs, fills and bonds to iron, steel, brass, bronze, aluminum and copper.
- Once cured, it can be drilled, tapped, threaded, filled, sanded, and painted.
- Resists most automotive, shop and cleaning fluids.
- Withstands temperature to 300° F intermittent.
- Over 3,000 PSI shear strength on steel.
- Suggested applications: Aluminum, steel, brass, bronze, castings and stampings.

Order No.	Mfg. No. / Description	List Price
545016	(14600) (2) 1 oz. Tubes	\$6.79 H0-7040000

Permatex 5 Minute General Purpose Epoxy



- Versatile, easy-to-use, general purpose epoxy adhesive is two-part adhesive and filler system that eliminates the need for welding or brazing.
- Sets in five minutes, no clamping needed.
- Clear appearance.
- Fills gaps and will not shrink.
- Resistant to water and solvents.
- Temperature range -60° F to 180° F.
- Permanent strength up to 3400 PSI.
- Self-mixing dual syringe (84164) blends the adhesive and filler as it dispenses, eliminating the need for manual mixing.

Order No.	Mfg. No. / Description	List Price
5450130	(84101) .84 fl. oz.	\$4.99 H0-9920000

3M Super Trim Spray Adhesive



- A high performance aerosol contact adhesive.
- Designed for bonding vinyl tops, heavy weight liners and hood silencer pads where high strength and head resistance are needed.

Order No.	Mfg. No. / Description	List Price
856535	(08090) 19 fl. oz.	\$31.89 F0-2322000

3M Super 77™ Multipurpose Spray Adhesive



- A high tack, high coverage and fast drying for permanently attaching foils, carpeting, lightweight foams, paper, cardboard, felt and cloth to painted or unpainted metals, wood and hardboard.
- Low soak-in for long lasting bond.
- Bonding, attaching, adhering, fastening, securing, gluing, tacking, sticking, gripping, hanging.

Order No.	Mfg. No. / Description	List Price
856537	(21210) 24 fl. oz.	\$20.59 F0-1441000

3M Marine Adhesive/Sealant 5200



- High performance polyurethane adhesive/sealant becomes tack free in 48 hours, cures completely in 5 - 7 days.
- Effectively absorbs stress caused by shock, vibration, swelling and shrinking.
- Retains its strength above or below the waterline.
- Excellent resistance to weathering and saltwater.
- Won't sag or flow in vertical or horizontal seams.

Order No.	Mfg. No. / Description	List Price	
856053	(05206) 1 oz. Tube White	\$10.89	F0-2670000
856027	(05203) 3 oz. Tube White	\$17.99	F0-9521000
856041	(05205) 3 oz. Tube Black	\$17.99	F0-9521000
856091	(06500) 10 oz. Cartridge White	\$23.89	F0-2761000
856104	(06501) 10 oz. Cartridge Tan	\$24.49	F0-4171000
856116	(06502) 10 oz. Cartridge Mahogany	\$26.19	F0-3381000
856130	(06504) 10 oz. Cartridge Black	\$23.89	F0-2761000
856003	(21463) 5 Gallon Pail White	\$1,199.99	F0-9993800

3M Marine Adhesive/Sealant Fast Cure 5200



- A faster curing version of 3M Marine Adhesive/Sealant 5200. Cures in approximately 24 hours.
- A one-part polyurethane that chemically reacts with moisture to deliver strong, flexible bonds to wood, gelcoat and fiberglass.
- Retains its strength above or below the waterline.
- Effectively absorbs stress caused by shock, vibration, swelling and shrinking.
- Excellent resistance to weathering and saltwater.
- Won't sag or flow in vertical or horizontal seams.

Order No.	Mfg. No. / Description	List Price	
856134	(06535) 1 oz. Tube White	\$12.49	F0-4780000
856135	(05220) 3 oz. Tube White	\$19.89	F0-2931000
856136	(06520) 10 oz. Cartridge White	\$27.29	F0-0191000

3M Marine Adhesive/Sealant Fast Cure 4200



- A one-part, general all-purpose polyurethane that chemically reacts with moisture to deliver flexible bonds with good adhesion to wood, fiberglass, gelcoat, plastics and metals.
- Paintable and sandable.
- Forms watertight, weather resistant seals on joints and boat hardware above or below the waterline.
- Medium strength allows for disassembly.
- Not recommended for sealing wood decks because it may be permanently softened by certain teak cleaners or sealers.

Order No.	Mfg. No. / Description	List Price	
856140	(05260) 3 oz. Tube White	\$17.89	F0-2521000
856142	(06560) 10 oz. Cartridge White	\$23.59	F0-1561000
856144	(06564) 10 oz. Cartridge Black	\$23.59	F0-1561000

3M Marine Adhesive/Sealant Fast Cure 4000 UV



- A one-part adhesive sealant that cures to form a firm, rubbery waterproof seal.
- Its superior UV resistance properties makes this an ideal cosmetic adhesive sealant.
- Designed for marine applications above or below the waterline.
- Its flexibility allows for the dissipation of stress caused by shock, vibration, swelling or shrinking.
- May be used in typical bedding and sealing applications including fiberglass hull, wood to fiberglass, porthole frames, deck fittings, moldings, through hull and deck hardware.

Order No.	Mfg. No. / Description	List Price	
856153	(05280) 3 oz. Tube White	\$16.89	F0-2811000
856154	(06580) 10 oz. Cartridge White	\$21.89	F0-2351000

3M Marine Grade Mildew Resistant Silicone Sealant



- A high quality silicone designed for the harsh marine environment.
- It forms a mildew resistant non-yellowing seal that remains flexible even after years of exposure.
- Sealing applications on fiberglass, wood, metal rubber and vinyl.
- Ideal for sealing trim, hatches, drip rails and moldings.
- Excellent gasket adhesive.

Order No.	Mfg. No. / Description	List Price	
856318	(08017) 3 oz. Tube White	\$14.29	F0-0001000
856332	(08019) 3 oz. Tube Clear	\$14.29	F0-0001000
856356	(08027) 10 oz. Cartridge White	\$34.49	F0-4142000
856370	(08029) 10 oz. Cartridge Clear	\$34.49	F0-4142000

3M Marine Polyurethane Adhesive Sealant 550 Fast Cure



- Fast set and cure time for fast-paced processes and productivity.
- Elastic formula creates high-strength bonds.
- Multi substrate bonder works on a wide variety of similar and dissimilar substrates.
- One component adhesive for easy application with no mixing or guesswork.
- Paintable after curing for professional results.
- A low viscosity adhesive that has a fast set time and creates a permanently elastic bond.
- Ideal for bonding a variety of similar and dissimilar materials.
- The low viscosity formula is ideal for creating very thin bond lines.

Order No.	Mfg. No. / Description	List Price	
856095	(62791) 10 oz. Cartridge	\$11.09	F0-6770000



SPECIAL HANDLING MAY APPLY



- Electronics
- Trolling Motors
- Instruments
- Electrical
- Lighting
- Anchor & Dock
- Safety
- Steering, Controls
- Pumps
- Fuel System
- Seating & Pedestals
- Trailering
- Tops & Covers
- Perform.
- Propellers
- Engine & Care
- Cleaning & Care
- Paint & Paint Acc.
- Fun & Flotation
- Topside Acc.
- Cockpit & Deck
- Hardware, Fasteners
- Camouflage
- Misc.
- Comm.

BoatLIFE Life-Seal® Sealant



- A unique combination of marine silicone and polyurethane, formulated especially for fiberglass.
- Offers a fast-curing, low odor, high adhesion, non-sagging, non-corrosive, non-yellowing formula.
- May be used above or below the waterline.
- Will adhere to metal, glass, wood, Lexan, ABS and certain other materials.
- Cures in presence of water.
- Mildew resistant and acid free.

Order No.	Mfg. No. / Description	Color	List Price	Part No.
248612	(1109) 1 fl. oz. Tube	Clear	\$8.99	GO-2060000
248624	(1160) 2.8 fl. oz. Tube	Clear	\$11.19	GO-0570000
248635	(1161) 2.8 fl. oz. Tube	White	\$11.19	GO-0570000
248662	(1169) 10.48 fl. oz. Cart.	Clear	\$20.79	GO-3931000
248674	(1170) 10.48 fl. oz. Cart.	White	\$20.79	GO-3931000
248675	(1171) 10.48 fl. oz. Cart.	Black	\$22.29	GO-3941000

BoatLIFE Silicone Rubber

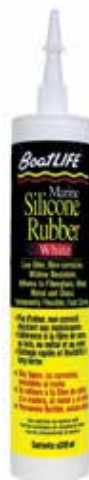

- An all-purpose, non-corrosive, non-yellowing, mildew resistant, low-odor, 100% marine high quality silicone sealant.
- Tack-free in 30 minutes or less. Fully cured in 24 hours.
- For use above or below the waterline.
- Will not shrink, crack, or dry out.
- Superior flexibility and adhesion to fiberglass, plastic, metal, and wood.
- Acid free cure will not corrode metal.

Order No.	Mfg. No. / Description	Color	List Price	Part No.
248614	(1140) 2.8 fl. oz. Tube	Clear	\$9.29	GO-2260000
248616	(1141) 2.8 fl. oz. Tube	White	\$9.29	GO-2260000
248618	(1142) 2.8 fl. oz. Tube	Black	\$9.29	GO-2260000
248619	(1150) 10.48 fl. oz. Cart.	Clear	\$17.79	GO-2911000
248620	(1151) 10.48 fl. oz. Cart.	White	\$17.79	GO-2911000
248621	(1152) 10.48 fl. oz. Cart.	Black	\$17.79	GO-2911000

Marpro Marine Grade Silicone Sealant



- This high performance silicone which exhibits excellent adhesion to glass, metal, porcelain, ceramic, fiberglass and other non-porous surfaces.
- Cures to a tough, rubbery and permanently flexible sealant.
- Sold in packs of 4 only.

Order No.	Description	Color	List Price	Part No.
7-2505	10.1 oz. Cartridge	Clear	\$10.99	FO-9670000
7-2507	10.1 oz. Cartridge	White	\$10.99	FO-9670000

BoatLIFE Life-Calk® Sealant



- A long lasting, permanently flexible marine polysulfide sealant which can be sanded, painted and used above and below the waterline.
- Tack-free in 1 to 3 days.
- Excellent resistance to teak oils, gasoline and diesel fuel.
- Will bond to fiberglass, wood, metal, glass and itself.
- Cures to a firm flexible rubber seal with excellent waterproofing and adhesion qualities.
- Can be applied to damp surfaces.

Order No.	Mfg. No. / Description	Color	List Price	Part No.
248460	(1030) 2.8 fl. oz. Tube	White	\$12.89	GO-4680000
248472	(1031) 2.8 fl. oz. Tube	Black	\$12.89	GO-4680000
248509	(1033) 10.48 fl. oz. Cart.	White	\$23.79	GO-4951000
248511	(1034) 10.48 fl. oz. Cart.	Black	\$23.79	GO-4951000

Star Brite Marine Silicone Sealant



- 100% marine grade silicone - won't turn yellow.
- Remains flexible from -60° F to +450° F.
- Bonds to fiberglass, plastic, wood, glass and metal.
- Unaffected by sunlight, weathering, most chemicals and solvents.
- Dries tack-free in less than one hour, cures completely in 24 hours.

Order No.	Mfg. No. / Description	Color	List Price	Part No.
626072	(082101) 2.8 oz. Tube	White	\$10.29	GO-9860000
626070	(082102P) 2.8 oz. Tube	Clear	\$10.29	GO-9860000
626076	(082103) 2.8 oz. Tube	Black	\$10.29	GO-9860000
626078	(082121) 10.1 oz. Cart.	White	\$17.79	GO-2911000
626079	(082122) 10.1 oz. Cart.	Clear	\$17.79	GO-2911000
626080	(082123) 10.1 oz. Cart.	Black	\$17.79	GO-2911000

BoatLIFE Life-Calk® Solvent and Cleaner



- Cleans surfaces prior to caulking with Life-Calk, Life Seal, silicone or Teak Deck Sealant.
- Safe for fiberglass.
- Removes uncured polysulfide sealant and grease from tools and equipment.
- Acetone free formula.

Order No.	Mfg. No. / Description	List Price	Part No.
248573	(1056) Pint (16 oz.)	\$26.39	GO-8671000

- Electronics
- Trolling Motors
- Instruments
- Electrical
- Lighting
- Anchor & Dock
- Safety
- Steering, Controls
- Pumps
- Fuel System
- Seating & Pedestals
- Trailer
- Tops & Covers
- Perform.
- Propellers
- Engine & Care
- Cleaning & Care
- Paint & Paint Acc.
- Fun & Flotation
- Topside Acc.
- Cockpit & Deck
- Hardware, Fasteners
- Camouflage
- Misc.
- Comm.

Caulking Gun



- All welded construction.
- Size: 10.1 oz.
- Smooth rod.
- A reliable tool to deliver caulk.

Order No. Mfg. No. / Description List Price
249107 (6000) **\$4.19** HO-1520000



Marpro Floatation Foam



- A 1 to 1 mix liquid urethane foam with 2 pounds per cubic foot density which is not affected by solvents or gasoline.
- Produces 4 cubic feet per gallon.
- It bonds to wood, metal or fiberglass and foams wherever it is poured.
- Provides extra flotation in boats and sound proofs and insulates hulls, walls, floors, seats, decks or any cavity.
- Do not use below 70° F.

Order No.	Description	List Price
6-7560	2 Quart 2 lbs. Density	\$37.49 F0-4262000
6-7562	2 Gallon 2 lbs. Density	\$126.09 F0-6288000
6-7565	2 Quart 4 lbs. Density	\$37.49 F0-4262000
6-7566	2 Gallon 4 lbs. Density	\$126.09 F0-6288000

Permatex Aviation Form-A-Gasket® No. 3 Sealant Liquid



- Slow-drying, non-hardening brush-top sealant approved for use in aviation as well as automotive applications.
- Temperature range -65° F to 400° F (-54° C to 204° C); resists gasoline, oil and grease.
- Suggested applications: Close-fitting machined surfaces, sealing hoses and solid gaskets.

Order No. Mfg. No. / Description List Price
545080 (80019) 4 oz. Bottle **\$7.59** HO-5540000

3M Super Weatherstrip and Gasket Adhesive



- A strong, flexible, rubbery adhesive that can withstand vibration, oil, grease, and extreme temperature variations.
- It can be used to bond weatherstripping to car doors, trunks, T-tops, moon roofs and sun roofs.
- Excellent adhesive for holding paper, cork, or rubber gaskets in place during installation.

Order No. Mfg. No. / Description List Price
856533 (08001) 5 oz. Tube **\$8.69** F0-8060000

3M Ultrapro™ High Temp Silicone Gasket



- A rapid curing form-in-place silicone gasket adhesive/sealant for use on engines.
- It is a flexible, noncorrosive, oxygen sensor safe compound that can be used as a gasket material for valve covers, oil pans and other engine and transmission applications.
- Can be used in applications up to 600° F including valve covers, oil and transmission pans, intake manifolds, water pumps, timing chain covers and thermostat housings.
- Black.

Order No. Mfg. No. / Description List Price
856382 (08672) 3 oz. Tube **\$10.49** F0-4370000

Permatex Super "300" Form-A-Gasket® Sealant



- Non-hardening sealant designed to resist heat transfer fluids such as oil or antifreeze.
- Temperature range -65° F to 400° F (-54° C to 204° C); resists antifreeze, aviation fuels, aggressive detergent bearing oils and lubricants.
- Suggested applications: Valve cover gaskets, compressors and diesel engine heads.

Order No. Mfg. No. / Description List Price
5450129 (80057) 4 oz. Bottle **\$6.99** HO-9140000

Cleaning & Care

- Electronics
- Trolling Motors
- Instruments
- Electrical
- Lighting
- Anchor & Dock
- Safety
- Steering, Controls
- Pumps
- Fuel System
- Seating & Pedestals
- Trailer
- Tops & Covers
- Perform.
- Propellers
- Engine & Care
- Cleaning & Care
- Paint & Paint Acc.
- Fun & Flotation
- Topside Acc.
- Cockpit & Deck
- Hardware, Fasteners
- Camouflage
- Misc.
- Comm.

SPECIAL HANDLING MAY APPLY

Permatex Form-A-Gasket® No. 2 Sealant



- Slow-drying, non-hardening brush-top sealant approved for use in aviation as well as automotive applications.
- Temperature range -65° F to 400° F (-54° C to 204° C); resists gasoline, oil and grease.
- Suggested applications: Valve cover gaskets and oil pan gaskets.

Order No. **545078** Mfg. No. / Description (80015) 1.5 oz. Tube List Price **\$3.89** HO-3320000

Permatex Ultra Copper® RTV Silicone Gasket Maker



- OEM specified.
- For high operating temperatures common in 4 cylinder, turbocharged or high-performance engines.
- Sensor-safe, low odor, noncorrosive.
- Superior adhesion.
- Temperature range -65° F to 700° F (-54° C to 371° C) intermittent; resists auto and shop fluids and vibration.
- Suggested applications: Exhaust manifolds/headers, valve covers, oil pans, intake manifold end seals, water pumps and exhaust tubes.

Order No. **545155** Mfg. No. / Description (81878) 3 oz. Tube List Price **\$7.49** HO-9440000

Permatex High-Temp Red RTV Silicone Gasket Maker



- OEM specified.
- Formulated for hi-temp applications or heavy duty use.
- Replaces almost any cut gasket by making gaskets that resist cracking, shrinking and migrating caused by thermal cycling.
- Coats pre-cut gaskets to increase reliability.
- Temperature range -65° F to 650° F (-54° C to 343° C) intermittent; resists auto and shop fluids.
- Suggested applications: Valve covers, oil pans, timing covers, water pumps, thermostat housing.

Order No. **545129** Mfg. No. / Description (81160) 3 oz. Tube List Price **\$7.19** HO-1340000

Permatex Ultra Black® RTV Silicone Gasket Maker



- OEM specified.
- Fast-curing formula.
- Sensor-safe, low odor, noncorrosive.
- Meets performance specs of OE silicone gaskets.
- Retains high flexibility, oil resistance properties through use of patented adhesion system.
- Temperature range -65° F to 500° F (-54° C to 260° C) intermittent; resists auto and shop fluids and vibration.
- Suggested applications: Valve covers, oil pans, intake manifold end seals, timing covers, water pumps and thermostat housings.

Order No. **545167** Mfg. No. / Description (82180) 3.35 oz. Tube List Price **\$7.19** HO-1340000

Permatex Sensor-Safe Blue RTV Silicone Gasket



- OEM specified.
- The original Permatex Blue now with low odor formula.
- Will not foul oxygen sensors.
- Replaces almost any cut gasket.
- Makes reliable "formed-in-place" gaskets that resist cracking, shrinking and migrating.
- Coats pre-cut gaskets to increase reliability.
- Temperature range -65° F to 500° F (-54° C to 260° C) intermittent; resists auto and shop fluids.
- Suggested applications: Valve covers, oil pans, intake manifold end seals, timing covers, water pumps and thermostat housings.

Order No. **545092** Mfg. No. / Description (80022) 3 oz. Tube List Price **\$4.79** HO-7820000

Permatex Anaerobic Gasket Maker



- OEM specified.
- Noncorrosive gasketing material designed primarily for use on aluminum, iron and steel flanged mating surfaces.
- Ideal for on-the-spot and emergency repairs, or when a conventional gasket is unavailable.
- Fills gaps up to .015" and cures to a solvent resistant seal that will not tear or decay during service.
- Suggested applications: Water pumps, thermostat housings, crank case flanges drive unit joints and O-ring replacement.

Order No. **5450115** Mfg. No. / Description (51817) .20 oz. Tube List Price **\$5.69** HO-1430000
 Order No. **545042** Mfg. No. / Description (51813) 1.69 oz. Tube List Price **\$17.49** HO-9401000

- Electronics
- Trolling Motors
- Instruments
- Electrical
- Lighting
- Anchor & Dock
- Safety
- Steering, Controls
- Pumps
- Fuel System
- Seating & Pedestals
- Trailing
- Tops & Covers
- Perform.
- Propellers
- Engine & Care
- Cleaning & Care
- Paint & Paint Acc.
- Fun & Flotation
- Topside Acc.
- Cockpit & Deck
- Hardware, Fasteners
- Camouflage
- Misc.
- Comm.

Corrosion Technologies CorrosionX



- CorrosionX is the most advanced and effective corrosion prevention compound, lubricant and penetrant in the world!
- Although it may look like an typical oil-based anti-corrosion spray, CorrosionX utilizes a revolutionary technology called Polar Bonding that does far more than merely slow down the corrosion process; CorrosionX actually kills existing rust and corrosion (keeping it from spreading) and provides long-term protection against rust and corrosion on any metal surface.
- Because it sticks to metal, it cannot be easily displaced by pressure, friction or moisture. It lubricates under extreme loads and high temperatures.
- The VOC of CorrosionX is only 4-7%. That's less than 1/10th what is in our competitors products.



Order No.	Mfg. No. / Description	List Price	
302953	(90101) 6 oz.	\$11.99	F0-9380000
302954	(90102) 16 oz.	\$20.09	F0-6041000

Corrosion Technologies CorrosionX Heavy Duty



- It is for super long-term protection against serious rust and corrosion assault.
- A high performance, thick-film version of CorrosionX.
- It was developed specifically to provide maximum protection against moisture intrusion and resulting rust and corrosion.
- Highly recommended for use on boat trailers.
- CorrosionX Heavy Duty forms a dripless, dynamic, non-hardening, self-healing film that stubbornly resists erosion by splash or spray - including complete submersion in saltwater.
- It will slowly penetrate existing rust and corrosion, remove moisture and stop electrolysis.
- Unlike wax coatings, it will not dry out, stiffen or crack under stress.
- It will remain for hours on outdrives, even while underway!



Order No.	Mfg. No. / Description	List Price	
302961	(90104) 12 oz.	\$17.39	F0-7121000

T-9 Rust and Corrosion Protection Lubrication



- Waterproof lubrication.
- Combination of solvents, lubricants and waxes designed for penetration, moisture displacement, lubrication and protection.
- Loosens rusty and corroded parts.



Order No.	Mfg. No. / Description	List Price	
290700	(T90004) 4 oz.	\$8.09	G0-2450000
290712	(T90012) 12 oz.	\$15.99	G0-1701000

OMC® Systematched™ Anti-Corrosion Spray



- Protects engine from external rust and corrosion.



Order No.	Mfg. No. / Description	List Price	
E777193	(765745) 11 oz.	\$12.19	F0-3580000

OMC® Systematched™ Heavy Duty Lube



- Heavy duty anti-corrosion and anti-rust protection.
- Penetrates rust, reduces friction and displaces moisture.
- Environmentally responsible; won't harm electrical contacts, rubber, vinyl, wood or paint.



Order No.	Mfg. No. / Description	List Price	
E777192	(765744) 12 oz.	\$10.29	F0-0270000

Evinrude D.P.L.™ Light Duty Penetrating Lubricant



- Can be used in any application which calls for WD-40 or CRC 666.
- Will provide better anti-corrosion protection.
- Excellent as electrical wire and distributor cap dryer.
- Fully-formulated, multi-purpose lubricant for eliminating a variety of corrosion and lubrication problems.
- Offers excellent corrosion protection - even under severe salt water conditions.
- Displaces moisture.



Order No.	Mfg. No. / Description	List Price	
B777183	(777183) 12 oz.	\$11.19	F0-3870000

CRC Marine QD® Electronic Cleaner



- Cleans sensitive electronic components and contacts.
- Use on electronic engine controls, data sensors and wiring, GPS, fishfinders, computers, VCRs, stereos, CD and DVD players.
- Helps prevent contact failure or malfunction.
- Evaporates quickly. Leaves no residue.



Order No.	Mfg. No. / Description	List Price	
290255	(06102) 11 oz.	\$8.09	G0-2450000

CRC Marine Battery Terminal Protector



- Specially designed to protect battery terminals from corrosion, a leading cause of hard starting and battery failure.
- Provides a lead free soft protective coating.



Order No.	Mfg. No. / Description	List Price	
290445	(06046) 7.5 oz.	\$6.39	G0-8240000

- Electronics
- Trolling Motors
- Instruments
- Electrical
- Lighting
- Anchor & Dock
- Safety
- Steering, Controls
- Pumps
- Fuel System
- Seating & Pedestals
- Trailer
- Tops & Covers
- Perform.
- Propellers
- Engine & Care
- Cleaning & Care
- Paint & Paint Acc.
- Fun & Flotation
- Topside Acc.
- Cockpit & Deck
- Hardware, Fasteners
- Camouflage
- Misc.
- Comm.

CRC Marine Freeze-Off® Super Penetrant



- An unique formula that immediately drops the temperature of the area in direct contact with the spray.
- The freezing effect cracks rusted surfaces, allowing Freeze-Off to reach deeper and work more effectively than other penetrants.
- Low VOC Formula.

Order No.	Mfg. No. / Description	List Price
290128	(05002) 11.5 oz.	\$10.09 GO-6760000

CRC Marine Heavy Duty Silicone



- Clean, odorless, highly water resistant.
- Fights corrosion.
- Lubricates wood, nylon, rubber, metals, canvas and leather.
- Eliminates squeaking and binding.
- Lubricates from -40° F to 400° F.

Order No.	Mfg. No. / Description	List Price
290457	(06077) 9 oz.	\$5.59 GO-5730000

CRC Marine Heavy Duty Corrosion Inhibitor



- A long term, flexible corrosion inhibitor that protects and preserves metal surfaces, electrical connections, engine components and fasteners, subject to salt spray and high humidity.
- Also provides effective protection for steering and throttle linkages.

Order No.	Mfg. No. / Description	List Price
290306	(06026) 10 oz.	\$9.59 GO-3460000

CRC Marine 6-56® Multi-Purpose Lubricant



- Long lasting, superior lubrication that resists water and salt spray.
- Drives out moisture that can cause electrical failures and hard starting.
- Penetrates deep through rust and corrosion to loosen frozen parts.
- Starts wet engines.

Order No.	Mfg. No. / Description	List Price
290089	(06005) 5 oz.	\$5.29 GO-4530000
290091	(06006) 9 oz.	\$6.59 GO-2440000
290104	(06007) 11 oz.	\$7.59 GO-9050000
290117	(06008) Gallon	\$46.29 GO-1013000

CRC Marine Dry Lube with PTFE Technology



- Micro-thin film penetrates and bonds to aluminum, metals, wood, rubber, plastic and most surfaces.
- Reduce friction and drag.
- Seals out moisture and helps prevent corrosion.

Order No.	Mfg. No. / Description	List Price
289201	(06114) 10 oz.	\$13.19 GO-4880000

CRC Marine Premium Dielectric Grease



- An unique, non-curing compound used for sealing, protecting and electrical insulating. Improves electrical performance by reducing arcing and voltage drop.
- Also ideal for lubricating plastic and rubber.
- Improves electrical performance in adverse weather conditions.
- Patented finger-actuated delivery system for smooth, continuous coverage.

Order No.	Mfg. No. / Description	List Price
290267	(06113) 3.3 oz.	\$15.29 GO-4201000

CDI Electronics Dielectric Grease



- Silicone-based grease that's designed to seal out moisture and prevent corrosion on electrical connectors.
- It also disrupts the flow of electrical current, which makes it good for lubricating and sealing the rubber parts of electrical connectors.
- Commonly used for spark plug wires.

Order No.	Mfg. No. / Description	List Price
7000198	(991-9706)	\$56.39 FO-7493000

- Electronics
- Trolling Motors
- Instruments
- Electrical
- Lighting
- Anchor & Dock
- Safety
- Steering, Controls
- Pumps
- Fuel System
- Seating & Pedestals
- Trailer
- Tops & Covers
- Perform.
- Propellers
- Engine & Care
- Cleaning & Care
- Paint & Paint Acc.
- Fun & Flotation
- Topside Acc.
- Cockpit & Deck
- Hardware, Fasteners
- Camouflage
- Misc.
- Comm.

Penray Open Gear Lube



- Fortified with a finely dispersed Moly Sulfide in addition to a petroleum based extreme pressure lubricant.
- Ideal for use on all open gears.
- Resists temperature extremes.
- Reduces friction from metal-to-metal contact.

Order No.	Mfg. No. / Description	List Price
604324	(7003) 11 oz.	\$13.59 GO-1190000

Penray PR-3 Wrench-Eze and Lubricant



- Penetrates and lubricates rusted and sticky parts.
- Silicone-free formula is safe for body shop use.
- Displaces water, lubricates and protects metal parts.
- Reduces friction and helps silence squeaks.

Order No.	Mfg. No. / Description	List Price
604315	(4516) 11 oz.	\$7.19 GO-2840000

Deep Creep Multi-Use Penetrating Lubricant



- Made from highly refined petroleum oils - Resists heat and evaporation, protects from corrosion and moisture, lubricates and penetrates deep into metal parts and mechanisms.
- Helps to lubricate, clean and protect boat equipment from scum residues and salt corrosion.

Order No.	Mfg. No. / Description	List Price
2894015	(DC14) 14 oz.	\$9.29 FO-0560000

Permatex Anti-Seize Lubricant



- A highly refined blend of aluminum, copper and graphite lubricants.
- Use during assembly to prevent galling, corrosion and seizing due to weathering or chemicals.
- Assures easier disassembly.
- Temperature range: -60° F to 1,600° F.
- Salt, corrosion and moisture resistant.

Order No.	Mfg. No. / Description	List Price
545105	(80078) 8 oz. Bottle	\$10.69 HO-1460000
545131	(81343) 1 oz. Tube	\$4.39 HO-3620000

Ultra Tef-Gel



- ULTRA Tef-Gel lubricates and eliminates corrosion between dissimilar metals on fishing boats by preventing saltwater electrolytes from getting to the surface of those connecting metals.
- Preventing seizing, galling, and friction welding of stainless steel, Inconel, aluminum, and other nickel alloys.
- Tef-Gel contains no volatile solvents, will not evaporate, dry out, or wash away, providing long lasting protection and ease of disassembly years later.

Order No.	Mfg. No. / Description	List Price
665030	(TG-1) 20cc Tube	\$22.19 EO-4661000
665035	(TG-2T) 2 oz. Tub	\$32.69 EO-2542000

CRC Magic Oil™ Lock Lubricant and De-Icer



- Long lasting graphite formula lubricates seized and frozen locks allowing for smooth operation.
- Spray lightly in the keyhole of the lock.

Order No.	Mfg. No. / Description	List Price
290540	(05130) 0.4 oz.	\$3.69 GO-7420000

Corrosion Block



- State-of-the-art anti-corrosion/lubricant compound that has been specifically designed for marine use.
- Displaces moisture.
- Clean, clear, ultra-thin fluid compound which leaves a non-greasy atmospheric barrier to protect metal.
- Leaves no gummy residue.
- Protects the flexibility of rubber.
- Contains no wax, tar, asphalt, silicon, or Teflon.
- Kills corrosion and prevents future corrosion from occurring.
- Frees metal parts that are frozen by corrosion.
- Protects electrical systems and electronics from salt water, moisture, and corrosion.

Order No.	Mfg. No. / Description	List Price
447000	(CB-4) 4 oz.	\$12.99 GO-0780000
447010	(CB-12) 12 oz.	\$25.69 GO-1271000
447020	(CB-1G) Gallon	\$193.29 GO-0592100

- Electronics
- Trolling Motors
- Instruments
- Electrical
- Lighting
- Anchor & Dock
- Safety
- Steering, Controls
- Pumps
- Fuel System
- Seating & Pedestals
- Trailering
- Tops & Covers
- Perform.
- Propellers
- Engine & Care
- Cleaning & Care
- Paint & Paint Acc.
- Fun & Flotation
- Topside Acc.
- Cockpit & Deck
- Hardware, Fasteners
- Camouflage
- Misc.
- Comm.

CRC Marine White Lithium Grease



- Provides superior lubrications and durability in any weather and most temperatures.
- It is a versatile grease designed for applications requiring a long grease life.
- Will not wash off, melt or freeze.

Order No. **290344** Mfg. No. / Description (06037) 10 oz. List Price **\$6.49** GO-5340000

Sierra Lithium Spray Grease - White



- Multi-purpose spray lubricant for Marine applications.
- Ideal for lubricating shift components and miscellaneous applications where a light grease lubricant is required.
- Water and heat resistant.
- Prevents corrosion.

Order No. **1897301** Mfg. No. / Description (18-9730-1) 12 oz. List Price **\$11.33** ZO-7950000

Star Brite Marine Formula White PTFE® Lubricant



- Special PTFE formula will not wash off.
- Reduces wear and friction.
- Protects from -65° F to 650° F.
- Non-toxic, non-staining.
- The ultimate lubricant - exceeds performance of normal grease.
- Great on zippers, winches, etc.

Order No. **627161** Mfg. No. / Description (85504) 4 oz. List Price **\$14.49** GO-1790000

Penray Electric Motor Cleaner



- Safe, non-flammable cleaning agent for electrical system parts.
- Evaporation is quick, leaving no residue.
- Extension tube is included for more exacting spray pattern.

Order No. **604327** Mfg. No. / Description (7014) 19 oz. List Price **\$10.19** GO-3860000

Spray Nine Marine Grez-Off®



- A biodegradable, non-solvent heavy duty degreaser that easily cuts through oil, grease and grime.
- Cleans and dissolves heavy soils on inboard & outboard motors, machinery and dock equipment.
- Also recommended for bilge cleaning.

Order No. **437079** Mfg. No. / Description (30232) 32 fl. oz. List Price **\$11.49** HO-9860000

CRC Marine Battery Cleaner



- Removes corrosion from cables, terminals, cases and hold-downs.
- Neutralizes acid spills.
- Assures maximum battery current flow and promotes longer life.

Order No. **290433** Mfg. No. / Description (06023) 11 oz. List Price **\$4.19** GO-1820000

Corrosion Technologies ReelX

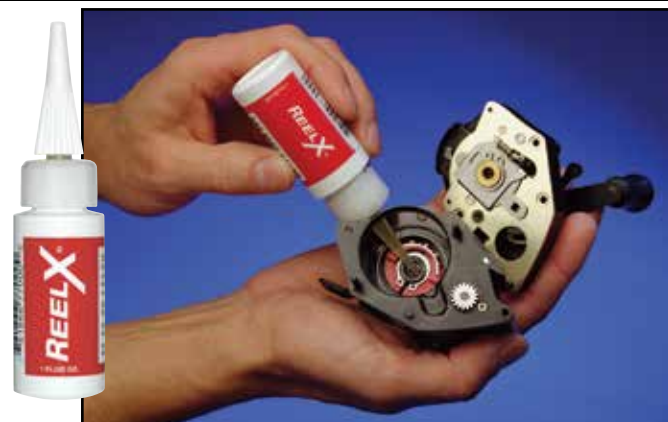

- ReelX is the new, hi-tech, extreme-pressure reel lubricant that virtually eliminates wear, disrupts existing corrosion and prevents new corrosion or rust from forming.
- ReelX contains no wax, tar, silicone or other solids, so it will never gum-up.
- ReelX will outperform any other lubricant on a fishing reel period.
- And it is backed with a 100% Money Back Guarantee.
- ReelX displaces moisture, and will not harm plastic, Teflon or monofilament.
- ReelX is not harmful to the environment.

Order No. **302951** Mfg. No. / Description (77000-1) 1 fl. oz. List Price **\$7.09** FO-6940000
302949 (77000) 1 fl. oz. (Case of 24) **\$168.59** FO-1081100

- Electronics
- Trolling Motors
- Instruments
- Electrical
- Lighting
- Anchor & Dock
- Safety
- Steering, Controls
- Pumps
- Fuel System
- Seating & Pedestals
- Trailering
- Tops & Covers
- Perform.
- Propellers
- Engine & Care
- Paint & Paint Acc.
- Fun & Flotation
- Topside Acc.
- Cockpit & Deck
- Hardware, Fasteners
- Camouflage
- Misc.
- Comm.

Cleaning & Care

Pencool® 2000 Engine Cooling System Treatment



- An unique liquid formula to keep diesel engines running cleaner.
- This easy-to-use product reduces scaling and corrosion and acts as a lubricant in the cooling system.
- Controls formation of harmful scale deposits, reduces metal corrosion and cavitation erosion and lubricates the water pump and other metal surfaces.
- Eliminates messy filters.

Order No.	Mfg. No. / Description	List Price	
603945	(2000-64) 1/2 Gallon	\$19.19	G0-6821000
604214	(2000-05) 5 Gallon	\$76.49	G0-5215000
604228	(2000-55) 55 Gallon	\$797.99	G0-5643500

Penray Fill-For-Life™ Heavy Duty 2-Way Test Strips



- Designed for use in standard and conventional coolants
- Check the condition of your cooling system in less than two minutes.
- Extremely precise.
- Determines freeze point and nitrite levels.

Order No.	Mfg. No. / Description	List Price	
603959	(TS-100) 50 Strips Per Bottle	\$41.79	G0-0082000

Rustfree™ Rust and Stain Remover



- Removes rust, corrosion and stains from virtually any surface, including: Steel, cast iron, stainless, fiberglass, chrome, tile, porcelain, concrete, vinyl, cloth and more.

Order No.	Mfg. No. / Description	List Price	
290736	(RF0008) 8 fl. oz.	\$10.29	G0-9860000

Pencool® 3000 Engine Cooling System Treatment



- An advanced cooling system treatment that helps prevent the formation of gel deposits in cooling systems.
- These deposits can plug radiator passages, aftercoolers, and oil coolers, & can cause excessive water pump wear.
- Blocks the formation of this gel, conditions cooling system water, and protects all cooling system metal components from corrosive attack.
- Use to maintain proper cooling system heat transfer characteristics and long engine life.

Order No.	Mfg. No. / Description	List Price	
604252	(3000-16) 16 fl. oz.	\$10.98	G0-6370000
604264	(3000-64) 1/2 Gallon	\$31.79	G0-0312000
604276	(3000-05) 5 Gallon	\$222.59	G0-4194100
604288	(3000-55) 55 Gallon	\$1,905.99	G0-1077210

Snee Rust Inhibitor Concentrate Phosphatizer



- A blend of acids and detergents that neutralizes rust and forms a phosphatized surface that inhibits the reformation of new rust and scales and prepares metal for painting.
- This rust solvent can be used as a preventative corrosion inhibitor.

Order No.	Mfg. No. / Description	List Price	
437011	(06 DC550) Gallon	\$35.29	F0-0742000

OSPHO Rust and Stain Remover



- Stops rust and prepares rusted surfaces for painting.
- When applied to rusted surfaces Oospho causes rust to chemically change to iron phosphate, an inert hard substance that turns the metal black.
- Note: Not UPSable.

Order No.	Description	List Price	
437036	Quart (Sold Pack of 12)	\$17.09	H0-5201000
437037	Gallon	\$35.89	H0-3512000



SPECIAL HANDLING MAY APPLY



- Electronics
- Trolling Motors
- Instruments
- Electrical
- Lighting
- Anchor & Dock
- Safety
- Steering, Controls
- Pumps
- Fuel System
- Seating & Pedestals
- Trailer
- Tops & Covers
- Perform.
- Propellers
- Engine & Care
- Cleaning & Care
- Paint & Paint Acc.
- Fun & Flotation
- Topside Acc.
- Cockpit & Deck
- Hardware, Fasteners
- Camouflage
- Misc.
- Comm.

Dr. Shrink Shrink Wrap



- Shrink wrap protects against weather damage.
- It's waterproof - it can fully encapsulate just about anything.
- One piece coverage.
- Cover entire flatbed loads and boats 60' + boats with one piece.
- 100% virgin resin shrink wrap with maximum UV inhibitors costs only pennies per square foot.
- Our shrink wrap covers can be ventilated to eliminate moisture and mildew problems.

SHRINK WRAP - 6 MIL

Order No.	Mfg. No.	Size	Color	List Price	
2228130	(DS-126175B)	12' W x 175' L	Blue	\$181.09	F0-6762100
2228133	(DS-126175W)	12' W x 175' L	White	\$181.09	F0-6762100
2228142	(DS-146150B)	14' W x 150' L	Blue	\$181.09	F0-6762100
2228145	(DS-146150C)	14' W x 150' L	Clear	\$181.09	F0-6762100
2228147	(DS-146150W)	14' W x 150' L	White	\$181.09	F0-6762100
2228149	(DS-146300B)	14' W x 300' L	Blue	\$362.19	F0-3535200
2228151	(DS-146300W)	14' W x 300' L	White	\$362.19	F0-3535200
2228162	(DS-166200W)	16' W x 200' L	White	\$275.99	F0-9139100
2228167	(DS-176031B)	17' W x 31' L	Blue	\$45.49	F0-4813000
2228169	(DS-176120B)	17' W x 120' L	Blue	\$175.99	F0-9132100
2228172	(DS-176120C)	17' W x 120' L	Clear	\$175.99	F0-9132100
2228174	(DS-176120W)	17' W x 120' L	White	\$175.99	F0-9132100
2228177	(DS-176270B)	17' W x 270' L	Blue	\$395.89	F0-2177200

Order No.	Mfg. No.	Size	Color	List Price	
2228179	(DS-176270W)	17' W x 270' L	White	\$395.89	F0-2177200
2228183	(DS-176410B)	17' W x 410' L	Blue	\$598.89	F0-2291400
2228188	(DS-176410W)	17' W x 410' L	White	\$598.89	F0-2291400
2228212	(DS-206100B)	20' W x 100' L	Blue	\$172.49	F0-4702100
2228215	(DS-206100C)	20' W x 100' L	Clear	\$172.49	F0-4702100
2228218	(DS-206100W)	20' W x 100' L	White	\$172.49	F0-4702100
2228220	(DS-206240W)	20' W x 240' L	White	\$413.99	F0-9798200
2228235	(DS-246045B)	24' W x 45' L	Blue	\$93.19	F0-3256000
2228237	(DS-246085B)	24' W x 85' L	Blue	\$175.99	F0-9132100
2228239	(DS-246085W)	24' W x 85' L	White	\$175.99	F0-9132100
2228242	(DS-246115B)	24' W x 115' L	Blue	\$237.99	F0-9566100
2228244	(DS-246115W)	24' W x 115' L	White	\$237.99	F0-9566100

SHRINK WRAP - 7 MIL

Order No.	Mfg. No.	Size	Color	List Price	
2228135	(DS-127149B)	12' W x 149' L	Blue	\$178.89	F0-2252100
2228138	(DS-127149W)	12' W x 149' L	White	\$178.89	F0-2252100
2228153	(DS-147128B)	14' W x 128' L	Blue	\$179.19	F0-3452100
2228155	(DS-147128W)	14' W x 128' L	White	\$179.19	F0-3452100
2228157	(DS-147213B)	14' W x 213' L	Blue	\$298.29	F0-0880200
2228159	(DS-147213W)	14' W x 213' L	White	\$298.29	F0-0880200
374065	(DS-147425B)	14' W x 425' L	Blue	\$598.89	F0-2291400
373996	(DS-147425W)	14' W x 425' L	White	\$598.89	F0-2291400
2228165	(DS-167200W)	16' W x 200' L	White	\$320.09	F0-6042200
2228191	(DS-177031W)	17' W x 31' L	White	\$52.79	F0-5963000
2228194	(DS-177110B)	17' W x 110' L	Blue	\$186.99	F0-9803100
2228196	(DS-177110W)	17' W x 110' L	White	\$186.99	F0-9803100
2228199	(DS-177175B)	17' W x 175' L	Blue	\$297.59	F0-1380200
2228202	(DS-177175W)	17' W x 175' L	White	\$297.59	F0-1380200
374067	(DS-177350B)	17' W x 350' L	Blue	\$598.89	F0-2291400
374000	(DS-177350W)	17' W x 350' L	White	\$598.89	F0-2291400
2228204	(DS-187200B)	18' W x 200' L	Blue	\$360.09	F0-6025200
2228207	(DS-187200W)	18' W x 200' L	White	\$360.09	F0-6025200
205750	(DS-187330B)	18' W x 330' L	Blue	\$583.19	F0-3280400
205756	(DS-187330W)	18' W x 330' L	White	\$598.89	F0-2291400
2228223	(DS-207089B)	20' W x 89' L	Blue	\$178.09	F0-6642100
2228225	(DS-207089W)	20' W x 89' L	White	\$178.09	F0-6642100
2228229	(DS-207200B)	20' W x 200' L	Blue	\$389.59	F0-1727200
2228228	(DS-207200W)	20' W x 200' L	White	\$400.09	F0-6008200
374071	(DS-207298B)	20' W x 298' L	Blue	\$598.89	F0-2291400
374010	(DS-207298W)	20' W x 298' L	White	\$598.89	F0-2291400
205889	(DS-207298C)	20' W x 298' L	Clear	\$598.89	F0-2291400
2228230	(DS-227100W)	22' W x 100' L	White	\$219.99	F0-9935100
2228247	(DS-247050W)	24' W x 50' L	White	\$120.09	F0-6048000
2228249	(DS-247120W)	24' W x 120' L	White	\$288.09	F0-6610200

Order No.	Mfg. No.	Size	Color	List Price	
374022	(DS-247248B)	24' W x 248' L	Blue	\$598.89	F0-2291400
374020	(DS-247248W)	24' W x 248' L	White	\$598.89	F0-2291400
2228252	(DS-267100B)	26' W x 100' L	Blue	\$260.09	F0-6028100
2228255	(DS-267100W)	26' W x 100' L	White	\$260.09	F0-6028100
2228257	(DS-267160W)	26' W x 160' L	White	\$415.89	F0-2119200
374179	(DS-267229B)	26' W x 229' L	Blue	\$598.89	F0-2291400
374030	(DS-267229W)	26' W x 229' L	White	\$598.89	F0-2291400
2228260	(DS-287064W)	28' W x 64' L	White	\$179.19	F0-3452100
2228264	(DS-287114B)	28' W x 114' L	Blue	\$310.89	F0-2671200
2228266	(DS-287114W)	28' W x 114' L	White	\$319.19	F0-3432200
374183	(DS-287213B)	28' W x 213' L	Blue	\$598.89	F0-2291400
374040	(DS-287213W)	28' W x 213' L	White	\$598.89	F0-2291400
2228265	(DS-287213C)	28' W x 213' L	Clear	\$598.89	F0-2291400
2228268	(DS-327065B)	32' W x 65' L	Blue	\$208.09	F0-6654100
2228271	(DS-327065W)	32' W x 65' L	White	\$208.09	F0-6654100
2228274	(DS-327100B)	32' W x 100' L	Blue	\$320.09	F0-6042200
2228276	(DS-327100C)	32' W x 100' L	Clear	\$320.09	F0-6042200
2228279	(DS-327100W)	32' W x 100' L	White	\$320.09	F0-6042200
374052	(DS-327186B)	32' W x 186' L	Blue	\$598.89	F0-2291400
374050	(DS-327186W)	32' W x 186' L	White	\$598.89	F0-2291400
2228283	(DS-367070W)	36' W x 70' L	White	\$252.09	F0-6467100
2228288	(DS-367165W)	36' W x 165' L	White	\$598.89	F0-2291400
2228292	(DS-407100B)	40' W x 100' L	Blue	\$400.09	F0-6008200
2228295	(DS-407100C)	40' W x 100' L	Clear	\$400.09	F0-6008200
2228297	(DS-407100W)	40' W x 100' L	White	\$400.09	F0-6008200
374291	(DS-407149B)	40' W x 149' L	Blue	\$598.89	F0-2291400
374060	(DS-407149W)	40' W x 149' L	White	\$598.89	F0-2291400
205890	(DS-407149C)	40' W x 149' L	Clear	\$598.89	F0-2291400
2228299	(DS-407200W)	40' W x 200' L	White	\$800.09	F0-6006500

SHRINK WRAP - 10 MIL

Order No.	Mfg. No.	Size	Color	List Price	
2228209	(DS-2010100W)	20' W x 100' L	White	\$287.49	F0-4210200

SHRINK WRAP - 2 MIL

Order No.	Mfg. No.	Size	Color	List Price	
440759	(DS-202200CPS)	20' W x 200' L	Clear	\$87.29	F0-0116000
440760	(DS-324100CPS)	32' W x 100' L	Clear	\$127.59	F0-1398000

SPECIAL HANDLING MAY APPLY



Dr. Shrink Measuring Film Width and Determining Support Posts Needed for Structure



RECREATION BOAT - FRONT

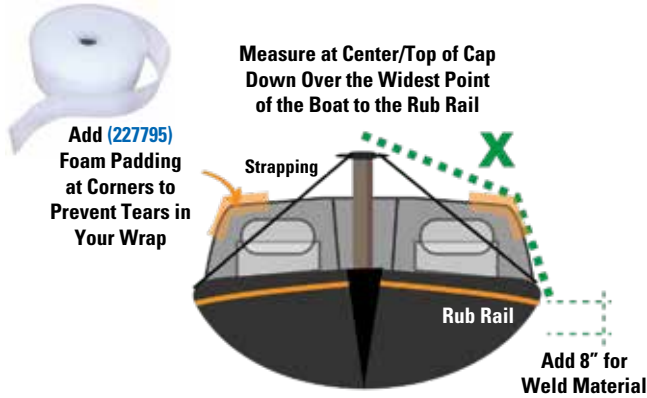

$((X+8'') \times 2) + 2' = \text{ROLL WIDTH}$

RECREATION BOAT - SIDE



PONTOON - FRONT

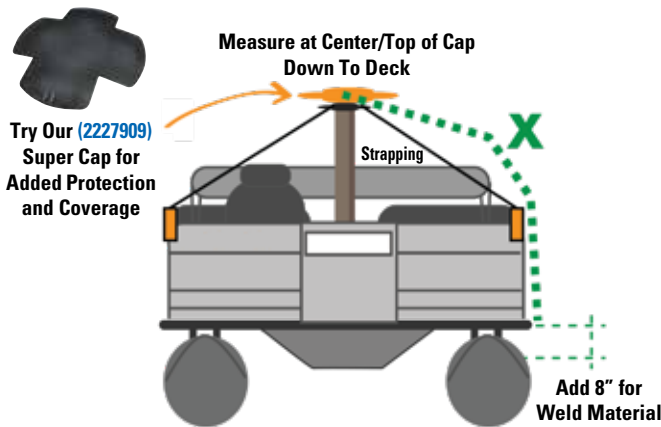

$((X+8'') \times 2) + 2' = \text{ROLL WIDTH}$

PONTOON - SIDE

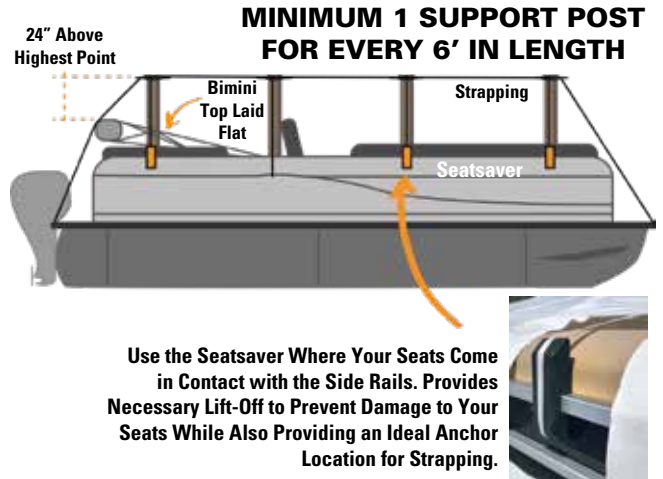

RECREATION BOAT VENTING CHART

Length	Beam	Film Size	# of Vents
0' - 16'	7'	12' x 149' (1,788 s.f.)	4
14' - 19'	8'	14' x 128' (1,792 s.f.)	4
17' - 24'	8.5'	17' x 110' (1,870 s.f.)	6
25' - 29'	8.5'	TWO IDEAL SIZES 20' x 89' (1,780 s.f.)	6
	9'	24' x 120' (2,880 s.f.)	6
28' - 31'	10'	26' x 100' (2,600 s.f.)	8

PONTOON BOAT VENTING CHART

Length	Beam	Film Size	# of Vents
0' - 16'	8'	17' x 110'	4
16' - 22'	8' - 9'	18' x 200'	6
23' - 28'	8' - 11'	20' x 89'	8

- Electronics
- Trolling Motors
- Instruments
- Electrical
- Lighting
- Anchor & Dock
- Safety
- Steering, Controls
- Pumps
- Fuel System
- Seating & Pedestals
- Trailering
- Tops & Covers
- Perform.
- Propellers
- Engine & Care
- Cleaning & Care
- Paint & Paint Acc.
- Fun & Flotation
- Topside Acc.
- Cockpit & Deck
- Hardware, Fasteners
- Camouflage
- Misc.
- Comm.

Dr. Shrink Ripack® 3000 Heat Tool



- 260,000 BTUs.
- The stainless steel nozzle can be turned a full 360° and prevents burns with its cold nozzle system.
- Weighs only 2.7 pounds.
- The kit includes: Heat tool with back-up igniter, 26' propane hose, Securipack - combined fail-safe regulator, high impact plastic case and wrench for tightening fittings.
- One year warranty.

Order No.	Mfg. No. / Description	List Price	
2227881	(DS-RPK3000)	\$1,091.29	FO-0936700

Dr. Shrink Rebuild Kit for Shrinkfast® 998 Heat Tool



- Kit includes:
- (1) #2 O-Ring (DS-998-02)
- (2) #6 O-Ring (DS-998-06/24)
- (2) Retainer (DS-998-07)
- (1) Left Housing w/Label (DS-998-16)
- (1) Right Housing w/Label (DS-998-15)
- (1) Trigger/Igniter (DS-998-17/18)
- (1) Safety (DS-998-20)
- Assembly Screws (DS-998-29)
- (1) Button (DS-998-31)
- (2) #33 O-Ring (DS-998-33)
- (1) Combustor w/Screen (DS-998-30A).

Order No.	Mfg. No. / Description	List Price	
2228366	(DS-998RB)	\$376.99	FO-9836200

Dr. Shrink Shrinkfast® 975 Heat Tool



- 200,000 BTUs.
- Propane fired heat too used to apply heat to shrink wrap.
- Kit includes: Heat tool, 25" propane hose, adjustable regulator, metal carrying case, wrench for tightening fittings and training DVD.

Order No.	Mfg. No. / Description	List Price	
2227893	(DS-SHFAST975)	\$1,170.69	FO-8491800

Dr. Shrink Shrinkfast® 998 Heat Tool



- The Shrinkfast 998 is a durable propane powered heat tool that puts out 212,000 BTUs at 22 pounds of pressure.
- The kit includes: Heat tool, 25' propane hose, adjustable regulator, wrench for tightening fittings and a professional training DVD.
- It comes in a plastic carrying case and has a one year warranty.
- Options include 2', 4' and 6' extensions.

Order No.	Mfg. No. / Description	List Price	
279504	(DS-SHFAST998)	\$766.65	ZO-9947500

Dr. Shrink Shrinkfast® 998 Extension



- Extensions for the 998 heat tool come in 2', 4' and 6' lengths to get all those hard-to-reach surfaces.
- Repair parts available for all extensions.
- Each sold separately.
- Heat tool and combustion not included.

Order No.	Mfg. No. / Description	List Price	
2227898	(DSSHFAST9982) Length 2'	\$535.79	FO-5057300
2227902	(DSSHFAST9984) Length 4'	\$555.59	FO-1988300
279516	(DSSHFAST9986) Length 6'	\$575.39	FO-7720400

Dr. Shrink Shrinkfast® 998 Arm Assist Clip



- The Arm Assist Clip provides the strength and support needed for those tall shrink wrap projects where the 4' or 6' extension is required.
- The lightweight aluminum design will reduce stress on your forearm while allowing for one-handed shrink wrapping.
- The Arm Assist Clip will fit any Shrinkfast 998 heat tool and works with the 4' and 6' extensions.
- Heat tool in picture not included.

Order No.	Mfg. No. / Description	List Price	
2227895	(SHFAST998-AR)	\$138.89	FO-2279000

Dr. Shrink Rapid Shrink 100 Heat Tool



- 100,000 BTUs.
- Kit includes: Heat tool, 25' propane hose, adjustable regulator, training DVD, safety gloves, safety glasses and carrying case.

Order No.	Mfg. No. / Description	List Price	
2227888	(DS-RS100)	\$446.49	FO-4521300

RAPID SHRINK 3' EXTENSION

Order No.	Mfg. No. / Description	List Price	
2227884	(DS-RS-EXT)	\$99.29	FO-0596000

Dr. Shrink Viking Cylinders Lightweight Composite Propane Tank



- Finally, an alternative to lugging around those heavy propane cylinders!
- 50% lighter than steel.
- The ergonomic handles allow for easy carrying and stacking.
- Thanks to the rugged, noncorrosive 3-layer composite, your fuel levels will always be visible so you'll never unexpectedly run out on the job.

Order No.	Mfg. No. / Description	List Price	
2227867	(DS-LWTANK-17) 17 lbs.	\$218.29	F0-0825100

Dr. Shrink Heat Shrink Tape - 9 Mil

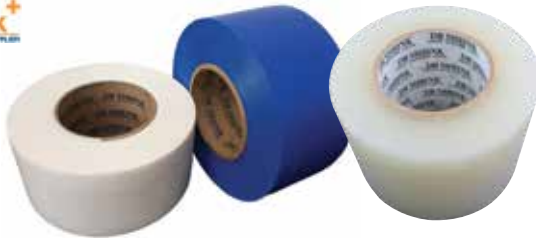

- Heat Shrink Tape is a 9 mil polyethylene tape that is designed to install doors and seal pleats, seams and holes.
- A powerful backing that adheres nicely to shrink wrap.

Order No.	Mfg. No.	Size	Color	List Price	
227909	(DS-702B)	2" x 180'	Blue	\$10.09	F0-6070000
227935	(DS-702W)	2" x 180'	White	\$10.09	F0-6070000
227961	(DS-702C)	2" x 180'	Clear	\$10.09	F0-6070000
2228324	(DS-702PW)	2" x 180'	White (Serrated Edge)	\$10.09	F0-6070000
2228327	(DS-703B)	3" x 180'	Blue	\$15.09	F0-6501000
2228340	(DS-703W)	3" x 180'	White	\$15.09	F0-6501000
227911	(DS-704B)	4" x 180'	Blue	\$20.09	F0-6041000
227947	(DS-704W)	4" x 180'	White	\$19.32	Z0-9441000
227973	(DS-704C)	4" x 180'	Clear	\$20.09	F0-6041000
2228344	(DS-704PW)	4" x 180'	White (Serrated Edge)	\$20.09	F0-6041000
227923	(DS-706B)	6" x 180'	Blue	\$30.09	F0-6012000
227959	(DS-706W)	6" x 180'	White	\$30.09	F0-6012000
227985	(DS-706C)	6" x 180'	Clear	\$30.09	F0-6012000

Dr. Shrink Anti-Chafe Tape - 3 Mil



- A high performance polyethylene film that provides a tough, puncture resistant material to prevent abrasion.
- This tape is designed as a low-tack film that will provide protection for your boat or other object.
- Use only between shrink wrap and the object.
- Simply apply it directly to the object where the shrink wrap touches.
- The tape acts as a barrier between the object and shrink wrap, thus preventing any scratching or chafing.
- The black underside of the tape contains UV inhibitors to prevent the sun from drying out the adhesive.

Order No.	Mfg. No.	Size	Color	List Price	
2227833	(DS-CHAFE3)	3" x 1,000'	White	\$45.09	F0-6513000
2227837	(DS-CHAFE66)	6" x 600'	White	\$47.29	F0-0133000
2227835	(DS-CHAFE6)	6" x 1,000'	White	\$75.69	F0-8925000
2227828	(DS-CHAFE126)	12" x 600'	White	\$94.49	F0-4166000
2227825	(DS-CHAFE12)	12" x 1,000'	White	\$151.19	F0-3850100
2227830	(DS-CHAFE24)	24" x 600'	White	\$188.89	F0-2223100

Dr. Shrink Clear Poly Sheeting - 4 Mil



- Made from polyethylene which provides optimum in economy and performance.
- It has great weather ability, chemical inertness and toughness which has made it successful in a wide variety of applications.
- Used in construction, industrial and agricultural applications.

Order No.	Mfg. No. / Description	List Price	
2228290	(DS-404100C) 40' W x 100' L	\$222.09	F0-6455100

Dr. Shrink Light Duty Heat Shrink Tape - 7.5 Mil



- Light duty heat shrink tape is a 7.5 mil polyethylene tape.
- Serrated edges.

Order No.	Mfg. No.	Size	Color	List Price	
2228320	(DS702.5W-7.5)	2.5" x 180'	White	\$11.29	F0-0970000
2228347	(DS-704WP)	4" x 180'	White	\$20.09	F0-6041000

Dr. Shrink Preservation Tape - 10 Mil

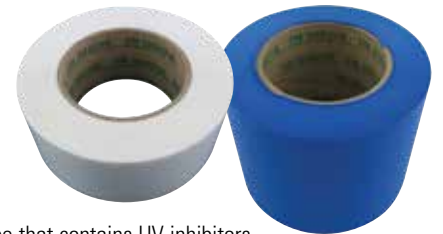

- A 10 mil waterproof tape that contains UV inhibitors for long term storage and leaves minimal adhesive residue.
- Most commonly used for transportation covers where the cover needs to be taped directly to the object.
- PLEASE NOTE: Although preservation tape is designed not to leave a residue, the adhesion is very strong and it is possible that the top layer of paint or finish may come off painted surfaces or wood. Please test a small area before applying to the entire surface.

Order No.	Mfg. No.	Size	Color	List Price	
227997	(DS-712W)	2" x 108'	White	\$11.49	F0-4080000
228002	(DS-713W)	3" x 108'	White	\$17.19	F0-3021000
222801	(DS-714W)	4" x 108'	White	\$22.89	F0-2061000
2228349	(DS-714B)	4" x 108'	Blue	\$22.89	F0-2061000

3M Preservation Sealing Tape - 4811

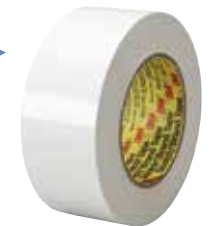

- The conformability and stain resistant properties of this white polyethylene tape offers excellent performance as an industrial and military preservation tape.
- Effective for many outdoor applications in hot and cold weather.
- Used for securing cover films for industrial commercial and marine equipment during storage and transportation.

Order No.	Mfg. No. / Description	List Price	
855410	(62334) 2" x 36 yards	\$66.39	F0-7464000

- Electronics
- Trolling Motors
- Instruments
- Electrical
- Lighting
- Anchor & Dock
- Safety
- Steering, Controls
- Pumps
- Fuel System
- Seating & Pedestals
- Trailer
- Tops & Covers
- Perform.
- Propellers
- Engine & Care
- Cleaning & Care**
- Paint & Paint Acc.
- Fun & Flotation
- Topside Acc.
- Cockpit & Deck
- Hardware, Fasteners
- Camouflage
- Misc.
- Comm.

Dr. Shrink Wrap n' Strap Knife



- One blade designated to cut strapping and the other blade used to make even, smooth cuts for shrink wrap.
- A combination of our innovative Ring Cutter and Film Knife tools, the Wrap n' Strap Knife is a handy, safe and convenient tool to cut your strapping and shrink wrap with a simple flip of the blade.
- The knife includes two additional blades for easy replacement.

Order No.	Mfg. No. / Description	List Price	
2228121	(DS-008) Wrap n' Strap Knife	\$11.99	F0-9380000
2228124	(DS-008R) Replacement Blades - Pack of 10	\$6.49	F0-4540000

Dr. Shrink Professional Shrink Wrap Knife



- Used to safely and smoothly cut shrink wrap during installation.
- No danger of scratching or cutting equipment with blade.

Order No.	Mfg. No. / Description	List Price	
228115	(DS-007) Shrink Wrap Knife	\$11.99	F0-9380000
228118	(DS-007R) Replacement Blades - Pack of 10	\$6.49	F0-4540000

Dr. Shrink Large Shrink Wrap Knife



- Large shrink wrap cutting knife.
- Hooked end for safety.
- Replacement blades available.

Order No.	Mfg. No. / Description	List Price	
2228118	(DS-007B)	\$15.89	F0-2111000

Dr. Shrink Disposable Shrink Wrap Knife



- Disposable film cutting knife.

Order No.	Mfg. No. / Description	List Price	
228103	(DS-007D)	\$2.29	F0-0610000

Dr. Shrink Strap Cutting Tool (Ring Cutter)



- Convenient strap cutting tool that allows the user to safely keep a blade available throughout the shrink wrapping process.
- Cuts woven cord strapping with ease.

Order No.	Mfg. No. / Description	List Price	
2227874	(DS-RCUT)	\$2.59	F0-1810000

Dr. Shrink Weather Tight Self-Adhesive Vent



- 4" x 5" self-adhesive, weather tight vent.
- Used to create a waterproof vent in a shrink wrap cover, allowing airflow under the cover, reducing moisture buildup without compromising the covers integrity.
- Scalloped edges with raised walls allow for vertical or horizontal installation.
- Please note: Vents should be applied to warm shrunk film to stick properly.

Order No.	Mfg. No. / Description	List Price	
227719	(DS-683) Black	\$2.19	F0-3510000
2228309	(DS-683W) White	\$2.19	F0-3510000

Dr. Shrink Solar Powered Vent



- Allows even more airflow underneath the shrink wrap by using two high speed solar powered fans to actively move air.
- It's water resistant, removes moisture and odors and has easy self-adhesive installation.
- Moves over 150 cubic ft of air per hour at 80% efficiency.

Order No.	Mfg. No. / Description	List Price	
2228307	(DS-683SP W) White	\$33.79	F0-5632000

Dr. Shrink Wind Powered Weather Tight Vents



- Wind powered 4" x 5" self-adhesive, weather tight vent.
- Allows airflow underneath the shrink wrap cover by using anemometer cups to spin blades to actively move air even with the slightest breeze.
- Can circulate air 24 hours a day.
- The cups can be rotated to either deliver air or remove it.
- Removable top for easy installation.
- Moves 150 cubic feet per hour with a 10 mph wind speed.

Order No.	Mfg. No. / Description	List Price	
2228312	(DS-683WVP B) Blue	\$7.99	F0-9550000
2228315	(DS-683WVP W) White	\$7.99	F0-9550000

Dr. Shrink Scoop Vent



- 12 ml triangular clear plastic vent.
- Provides airflow under shrink wrap to keep covered products moisture free.
- Pack of 6.

Order No.	Mfg. No. / Description	List Price	
2227890	(DS-SCOOP)	\$2.99	F0-9020000

Dr. Shrink Zipper Access Doors



- Doors are taped on the cover to allow access into a shrink wrapped object without compromising the durability of the cover.
- Use a film knife to cut the inside of the opening for access into the shrink wrapped object.
- All doors have double-pull zippers.

Order No.	Mfg. No. / Description	List Price
281105	(DS-36B) 30" x 36" Blue	\$9.99 F0-9960000
281206	(DS-36W) 30" x 36" White	\$9.99 F0-9960000
281307	(DS-36C) 30" x 36" Clear	\$9.99 F0-9960000
281319	(DS-48C) 30" x 48" Clear	\$11.99 F0-9380000
281117	(DS-3648B) 36" x 48" Blue	\$11.99 F0-9380000
281120	(DS-3648W) 36" x 48" White	\$11.99 F0-9380000
281118	(DS-3648C) 36" x 48" Clear	\$11.99 F0-9380000
2228351	(DS-72B) 36" x 72" Blue	\$35.79 F0-5052000
2228353	(DS-72C) 36" x 72" Clear	\$35.79 F0-5052000
2228356	(DS-72W) 36" x 72" White	\$35.79 F0-5052000

Dr. Shrink GoCart



- Easy assembly - easy takedown!
- This lightweight cart is durable and easy to maneuver.
- Four 8" lockable, rotating wheels make braking and handling a snap.

Order No.	Mfg. No. / Description	List Price
2227854	(DS-GOCART)	\$1,091.29 F0-0936700

Dr. Shrink Lifting Lug Cover



- Dr. Shrink has formulated an alternative option for quick & easy access to your lifting points.
- Each Lifting Lug Cover is a 12" x 12" square, made of premium 10-mil shrink wrap and extremely durable and sturdy.
- Each lug cover is easy to install, allowing quick and resealable access to lifting points.

Order No.	Mfg. No. / Description	List Price
2227865	(DSLCCZIPPERW)	\$13.89 F0-2790000

Dr. Shrink Heavy Duty Film Rack Cart



- The heavy duty film rack is built out of black powder coated steel and can hold up to four 200 pound rolls of shrink wrap - along with heat tools, propane tank, strapping and other supplies.
- The rack rolls on the extra large casters with locks for ease of use.
- It is ready to make the installation of shrink wrap much easier for you.
- NOTE: Due to the weight of this item, it must be shipped on a freight truck.

Order No.	Mfg. No. / Description	List Price
2227856	(DS-HDRACK)	\$1,289.69 F0-8720900

Dr. Shrink Utility Cart



- Lightweight two-wheeled Utility Cart with a spot for everything.
- Holds the propane tank, heat tool, hose, strapping, tape, buckles, etc.
- Rolls easily on 8" wheels.
- It will make you more efficient.

Order No.	Mfg. No. / Description	List Price
2228113	(DSUTILITYCAR)	\$644.89 F0-2415400

Dr. Shrink Film Rack



- The side rails are made of square steel tubing measuring 18".
- These rails are perfect for easy mounting on either the floor or the wall.
- The center pole is a 72" long piece of conduit sturdy enough to hold even the largest of shrink wrap rolls.

Order No.	Mfg. No. / Description	List Price
2227851	(DS-FILMRACK)	\$194.49 F0-4163100



SPECIAL HANDLING MAY APPLY



- Electronics
- Trolling Motors
- Instruments
- Electrical
- Lighting
- Anchor & Dock
- Safety
- Steering, Controls
- Pumps
- Fuel System
- Seating & Pedestals
- Trailer
- Tops & Covers
- Perform.
- Propellers
- Engine & Care
- Cleaning & Care
- Paint & Paint Acc.
- Fun & Flotation
- Topside Acc.
- Cockpit & Deck
- Hardware, Fasteners
- Camouflage
- Misc.
- Comm.

Electronics

Trolling Motors

Instruments

Electrical

Lighting

Anchor & Dock

Safety

Steering, Controls

Pumps

Fuel System

Seating & Pedestals

Trailer

Tops & Covers

Perform.

Propellers

Engine & Care

Paint & Paint Acc.

Fun & Flotation

Topside Acc.

Cockpit & Deck

Hardware, Fasteners

Camouflage

Misc.

Comm.

Dr. Shrink Heavy Duty Woven Cord Strapping

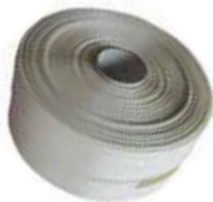

- Used with wooden uprights and buckles to form the support structure under shrink wrap covers.
- It is also used to create the perimeter band that will secure the shrink wrap material.

Order No.	Mfg. No.	Size	Break Strength	List Price	
2228302	(DS-500HD)	1/2" x 3,900'	900 lb.	\$107.99	F0-9557000
2228305	(DS-50015HD)	1/2" x 1,500'	900 lb.	\$48.99	F0-9243000
2228359	(DS-750HW)	3/4" x 1,665'	1,625 lb.	\$112.99	F0-9097000
2228361	(DS-7501500)	3/4" x 1,500'	900 lb.	\$63.69	F0-8544000
2228364	(DS-750300)	3/4" x 300'	900 lb.	\$20.49	F0-4341000

Dr. Shrink Strap Dispenser



- Durable and lightweight design which is compatible with all our premium 1/2" and 3/4" strapping rolls.
- The unit features a convenient carrying handle and low resistance spindle system.
- Ideal tool to prevent knots, tangles and twists in the strapping.

Order No.	Mfg. No. / Description	List Price	
2227907	(DS-STRAPDISP)	\$37.79	F0-5462000

Dr. Shrink Strapping Protector



- Designed for two different applications:
 - 1) A method of keeping strapping from forming dents in vinyl upholstery on boats.
 - 2) Used as corner guards to keep shrink wrap and strapping from being cut on sharp edges.
- Notched on all four sides for easy attachment to strapping.

Order No.	Mfg. No. / Description	List Price	
2227869	(DS-PROTECTOR)	\$2.09	F0-6410000

Dr. Shrink Super Cap



- Designed to transfer the weight of snow, ice and rain from the top of 2 x 4 support poles used under shrink wrap storage covers.
- Dome shaped and 20" in diameter, the Super Cap rests on the woven cord strapping running both lengthwise and crosswise, thus minimizing support poles from poking through shrink wrap covers.
- Super Caps can be easily attached to wooden uprights with either a nail or staples.

Order No.	Mfg. No. / Description	List Price	
2227909	(DS-SUPERCAP)	\$4.29	F0-0030000

Dr. Shrink End Caps and Bottom Caps



- Designed to fit on the top and bottom of 2 x 4 boards commonly used as a support poles under shrink wrap covers.
- The caps have slits every 90° for the woven cord strapping to slide into and when the cover is shrunk, the sections flex downward forming a protective pad on the top to eliminate pole poke-through. Bottom caps have non-skid disks attached for added stability.

Order No.	Mfg. No. / Description	List Price	
2227757	(DS-CAP) End Caps	\$1.49	F0-4010000
2227767	(DS-BCAP) Bottom Caps	\$2.89	F0-2020000

Regular Woven Cord Strapping

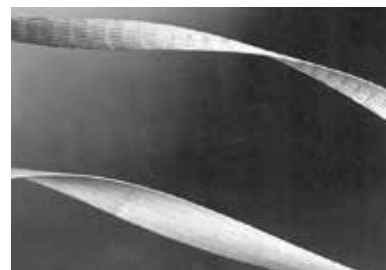

- Can be hand tied or secured and fastened with buckles.

Order No.	Mfg. No.	Size	Tensile	List Price	
427700	(P40RW15)	1/2" x 1,500'	650 lb.	\$66.49	L0-5233000
427715	(P40RW)	1/2" x 3,900'	650 lb.	\$157.89	L0-5987000
427730	(P60RW)	3/4" x 2,100'	950 lb.	\$141.99	L0-0017000

Dr. Shrink Tensioning Tool



- Used when creating the perimeter band.
- If the perimeter band is left only hand tightened, the cover will sit loosely over the object and can rub and chafe the object.
- A band properly tightened with the Tensioning Tool will create a powerful perimeter band that will hug the cover securely against the protected object, preventing movement and eliminating chafing.

Order No.	Mfg. No. / Description	List Price	
227858	(DS-15)	\$70.89	F0-2694000

Dr. Shrink Metal Buckles



- Used with the strapping and tensioning tool when creating a tight-fitting perimeter band.
- When creating the support structure, the buckles allow the installer to sufficiently hand tighten the strapping and produce a sturdy, sloping frame for the shrink wrap cover.
- 3/4" Heavy duty.
- Sold 100 per bag.

Order No.	Mfg. No. / Description	List Price	
227846	(DS-075)	\$17.89	F0-2521000

Dr. Shrink Liftoff Assembly



- The Liftoff is perfect for wrapped objects that need additional ventilation as well as surface protection (such as painted boat hulls or delicate machinery) during the wrapping process.

Order No.	Mfg. No. / Description	List Price	
2227859	(DS-LIFTOFF)	\$2.09	F0-6410000

Dr. Shrink Foam Block



- 3" x 2" x 22" foam block.
- Sold individually.

Order No.	Mfg. No. / Description	List Price	
2227845	(DS-FBLOCK)	\$2.99	F0-9020000

Dr. Shrink Easy Klips®



- Can reduce labor time by holding shrink wrap securely in place.
- Makes the shrink wrap process easier.
- Easy on/easy off application and fastens in seconds.
- Will not detach until you want it to.
- Instead of pulling off when the load gets heavy, the EasyKlip will actually clamp down harder and fastens without tearing the plastic.

Order No.	Mfg. No. / Description	List Price	
2227840	(DS-EASYKLIPB) Blue	\$2.49	F0-4710000
2227842	(DS-EASYKLIPW) White	\$2.49	F0-4710000

Dr. Shrink REBAG System - Roll of 50



- This program is available throughout the Continental U.S. for recycling shrink wrap.
- All you have to do is put your used shrink wrap covers or scraps into the bag, close it, put the prepaid FedEx label on it and then call FedEx for a pickup or take it to the nearest FedEx service center.
- This product is a roll of 50 REBAGS.
- One individual REBAG holds approximately 600 square feet of plastic.

Order No.	Mfg. No. / Description	List Price	
2227872	(DS-RBAG)	\$2,976.19	F0-3338020

Dr. Shrink Fuel Vent Cap



- Cap for covering the fuel vent while shrink wrapping.

Order No.	Mfg. No. / Description	List Price	
2227848	(DS-FCAP)	\$1.59	F0-1110000

Dr. Shrink Training DVD

- Dr. Shrink's training DVD.
- Included in each heat tool kit.

Order No.	Mfg. No. / Description	List Price	
2228115	(DS-0015CD)	\$29.79	F0-5802000

Dr. Shrink Foam Padding



- Covers sharp corners and edges from puncturing through your shrink wrap cover.
- 1/4" thick foam padding.
- 6" x 75' roll.

Order No.	Mfg. No. / Description	List Price	
2227795	(DS-675F)	\$23.39	F0-7361000

Dr. Shrink Long Cuff Safety Gloves



- Long cuff safety gloves designed to be used with heat tools.
- Long cuff protects wrists and clothing.
- Non-flammable, safe to use with open flame of heat tool.

Order No.	Mfg. No. / Description	List Price	
281150	(DS-009) White	\$9.27	Z0-5960000

Dr. Shrink TideMinder® Kits



- TideMinder kit - set of 9 balls.
- Each ball measures 3" and the center hole will accept up to a 1" line (inner dimension of hole is 1.25").
- Line is not included with kit.

Order No.	Mfg. No. / Description	List Price	
2228108	(DS-TMKITBK) Black	\$55.59	F0-1983000
2228110	(DS-TMKITW) White	\$55.59	F0-1983000

REPLACEMENT BALLS

Order No.	Mfg. No. / Description	List Price	
2228102	(DS-TMBALLBK) Black	\$9.99	F0-9960000
2228105	(DS-TMBALLW) White	\$9.99	F0-9960000

- Electronics
- Trolling Motors
- Instruments
- Electrical
- Lighting
- Anchor & Dock
- Safety
- Steering, Controls
- Pumps
- Fuel System
- Seating & Pedestals
- Trailering
- Tops & Covers
- Perform.
- Propellers
- Engine & Care
- Cleaning & Care
- Paint & Paint Acc.
- Fun & Flotation
- Topside Acc.
- Cockpit & Deck
- Hardware, Fasteners
- Camouflage
- Misc.
- Comm.

Star Brite Winter Tech -50° F Anti-Freeze



- Economical cold-weather protection for freshwater water systems and holding tanks.
- Propylene glycol and alcohol formula is safe for all water and holding tank materials.
- Bright Pink Color.
- Gallons sold 6 per case.
- **NOTE: This product is not recommended for use in engines.**

Order No.	Mfg. No. / Description	List Price
452246	(31100) Gallon	\$4.59

Star Brite Winter Safe -50° F Anti-Freeze



- Safe for copper, brass and all types of plastic.
- Non-toxic virgin propylene Glycol formula.
- Contain full ad pack and premium corrosion inhibitors.
- Protects water systems and engines from freeze ups during storage.
- Bright Pink Color.
- Gallons sold 6 per case.

Order No.	Mfg. No. / Description	List Price
452235	(31200) Gallon	\$4.79
452241	(312G55) 55 Gallon	\$256.89

Star Brite -50° F Non-Toxic Premium Anti-Freeze



- Protects water systems and engines from freeze ups during storage.
- Safe for copper, brass and all types of plastic.
- Non-toxic virgin propylene glycol formula.
- Bright Pink Color.
- Gallons sold 6 per case.

Order No.	Mfg. No. / Description	List Price
452209	(31400) Gallon	\$5.39
452212	(314G55) 55 Gallon	\$289.19

Star Brite -100° F Anti-Freeze



- Non-toxic virgin propylene glycol formula.
- Provides copper burst protection down to -100° F.
- Contains full ad pack and premium corrosion inhibitors.
- Blue Green Color.
- Gallons sold 6 per case.

Order No.	Mfg. No. / Description	List Price
452214	(31500) Gallon	\$9.59
452217	(315G55) 55 Gallon	\$518.19

Star Brite -200° F P.G. Anti-Freeze



- Safe for all engines including aluminum.
- Non-toxic virgin propylene glycol formula.
- Provides copper burst protection down to -200° F.
- Contains full ad pack and premium corrosion inhibitors.
- Concentrate.

Order No.	Mfg. No. / Description	List Price
452221	(316G55) 55 Gallon	\$895.49

Star Brite Anti-Freeze/Coolant - Full Strength



- Ethylene glycol base.
- For year-round use.
- Special premium low silicate formula.
- Green Color.
- Contains corrosion inhibitors which protect against rust and corrosion of aluminum, copper, solder and brass.
- Sold 6 per case.

Order No.	Mfg. No. / Description	List Price
452201	(30200) Gallon	\$13.79

Star Brite 50/50 Ready-To-Use Anti-Freeze/Coolant



- Ethylene glycol base.
- Lasts for 5 years, 300,000 miles or 6,000 hours.
- Protects all engine metals.
- Reduces formation of abrasive solids to help extend water pump life.
- Orange Color.
- Sold 6 per case.

Order No.	Mfg. No. / Description	List Price
452199	(30800) Gallon	\$15.49

Camco Anti-Freeze



- Protect your RV's potable water system from freeze damage.
- Inhibit fouling and corrosion while preventing algae growth.
- Lubricates pumps & valves throughout the system.
- Choose a temperature specific product designed for your winterizing needs.
- Safe and tasteless.

FREEZE BAN -50° F ANTI-FREEZE

Order No.	Mfg. No. / Description	List Price
206309	(30767) Gallon	\$5.19
206311	(30768) 55 Gallon	\$271.49

WINTER BAN -100° F ANTI-FREEZE

Order No.	Mfg. No. / Description	List Price
206347	(30787) Gallon	\$8.89
206349	(30788) 55 Gallon	\$468.99

Camco BanFrost 2000 Marine Engine Anti-Freeze



- Low toxicity biodegradable engine protection.
- Use for winter storage of raw water cooled engines and as a permanent anti-freeze/coolant for fresh water cooled systems.
- Replaces Ethylene Glycoat; safer for people, pets and wildlife.
- Sold 6 per case.

Order No.	Mfg. No. / Description	List Price
206361	(30627) Gallon	\$14.89

SPECIAL HANDLING MAY APPLY



- Electronics
- Trolling Motors
- Instruments
- Electrical
- Lighting
- Anchor & Dock
- Safety
- Steering, Controls
- Pumps
- Fuel System
- Seating & Pedestals
- Trailer
- Tops & Covers
- Perform.
- Propellers
- Engine & Care
- Paint & Paint Acc.
- Fun & Flotation
- Topside Acc.
- Cockpit & Deck
- Hardware, Fasteners
- Camouflage
- Misc.
- Comm.

Star Brite Do-It-Yourself Winterizing Kit



- For winterizing and descaling.
- All you need is a hose, flusher attachment and Star Brite Anti-Freeze.
- Quickly and easily descales inboard and outboard/engine cooling systems.
- Removes deposits to keep engines running cool.

Order No.	Mfg. No. / Description	List Price
460903	(35001)	\$62.59 G0-4914000

Camco Do It Yourself Boat Winterizer



- Quickly and efficiently service inboard/outboard marine engines.
- Also recommended for use with outboard engines.
- The patented Do-It-Yourself Winterizer allows flushing and preparation of boat engine for winter storage with just five gallons of antifreeze and your flusher.
- For front mounted raw water pump systems, use the Flush Adapter, sold separately.

Order No.	Mfg. No. / Description	List Price
689006	(65501)	\$52.59 F0-1863000

The Power House Ice Eater



- The Ice Eater is designed to prevent ice from forming around boats, marinas, docks and piers as well as effectively melting existing ice by breaking the surface with a continuous current of warmer bottom water.
- Ice Eater's propeller draws up warmer subsurface water and deflects it to the surface creating a constant circulation of warmer water that prevents ice formation.
- The Ice Eater may be hung from a pier or boat. Two to three feet is the average operating depth.
- The design of the Ice Eater's venturi shroud (housing) with outwardly flared ends, provides more upward thrust & draws warmer water from greater depths than other conventional de-icers.
- The shroud is submersible below the surface either vertically or angled from vertical. A set of mounting holes at opposed positions on the flange allows the lines to be attached.
- Each motor assembly includes: Propeller, zinc and 25' power cord.
- **423001** Specification: 1/2 HP, 6.5 amps (115V)/3.25 amps (230V), open diameter: 40', 28 lbs. of thrust.
- **423001** Specification: 3/4 HP, 6.0 amps (115V)/3.0 amps (230V), open diameter: 60', 32 lbs. of thrust.
- **423002** Specification: 1 HP, 7.0 amps (115V)/3.5 amps (230V), open diameter: 80', 36 lbs. of thrust.

Order No.	Mfg. No. / Description	List Price
423001	(P750) 3/4 HP, 115 Volt Motor Assembly	\$650.00 Z0-0067500
423002	(P1000) 1 HP, 115 Volt Motor Assembly	\$695.00 Z0-0552600
423003	(KT16110) Adjustable Thermostat 120V (0° to 80°)	\$90.69 E0-2086000

- Electronics
- Trolling Motors
- Instruments
- Electrical
- Lighting
- Anchor & Dock
- Safety
- Steering, Controls
- Pumps
- Fuel System
- Seating & Pedestals
- Trailer
- Tops & Covers
- Perform.
- Propellers
- Engine & Care
- Cleaning & Care
- Paint & Paint Acc.
- Fun & Flotation
- Topside Acc.
- Cockpit & Deck
- Hardware, Fasteners
- Camouflage
- Misc.
- Comm.

- Electronics
- Trolling Motors
- Instruments
- Electrical
- Lighting
- Anchor & Dock
- Safety
- Steering, Controls
- Pumps
- Fuel System
- Seating & Pedestals
- Trailer
- Tops & Covers
- Perform.
- Propellers
- Engine & Care
- Paint & Paint Acc.
- Fun & Flotation
- Topside Acc.
- Cockpit & Deck
- Hardware, Fasteners
- Camouflage
- Misc.
- Comm.

Kasco De-Icers



- Designed to prevent ice formation in marinas and ponds.
- Suspension ropes, hollow braided polypropylene. 20' x 5/16" lengths attached.
- Stainless steel safety cage; for propeller protection.
- #316 series stainless steel shaft, approved for salt water use.
- Bearings: Ball type, top and bottom.
- Flood oil lubricated for excellent heat dissipation.
- Large capacity dielectric oil provides lifetime lubrication and maximum cooling with no periodic maintenance required.
- Motor housing is corrosion-resistant stainless steel, a must for salt water operation.
- Permanent split capacitor (PSC) insures quick high torque starts and smooth operation.
- Compare water agitation to all other compressors and you'll choose agitation every time.
- Units have 25' power cords.
- Two year warranty.

Order No.	Mfg. No. / Description	List Price	
200200	(2400D025) 1/2 HP Up to 50' Diameter Circle	\$731.09	EO-2384500
200211	(3400D025) 3/4 HP Up to 75' Diameter Circle	\$804.09	EO-7030600
200222	(4400D025) 1 HP Up to 90' Diameter Circle	\$895.09	EO-2317600

Kasco De-Icer Control Panel



- An inexpensive way to control the operation of your de-icer.
- Uses an air temperature thermostat to turn the de-icer on when the temperature drops below a set point that you decide.
- One C-10 controls one 120V de-icer.

Order No.	Mfg. No. / Description	List Price	
200233	(110225)	\$96.29	D0-3077000

Kasco 25' Power Cable



- Water and oil resistant, remains flexible to minus 50° F.
- An exterior watertight de-leer connection allows for easy on-the-spot user replacement, saving the shipment of de-leers to the factory for power cable replacement.

Order No.	Mfg. No. / Description	List Price	
200288	(9116025)	\$57.69	EO-7234000

Kasco Horizontal Flotation Unit



- An exclusive, arctic proven flotation kit that is optional for all De-Icers.
- The easy-to-assemble kit consists of stainless steel components and a flotation block.
- The De-Icer unit is mounted horizontally to the surface of the water, just below the flotation block.
- The De-Icer can be angled in several positions; horizontal and above and below horizontal.

Order No.	Mfg. No. / Description	List Price	
200266	(213001)	\$266.89	D0-1531200

Kasco Universal Dock Mount



- Can be used with any Kasco De-Icer.
- Made from thermal plastic composites, corrosion protected steel and stainless steel to withstand the toughest marine conditions.
- The De-Icer is mounted to the "underwater parts" of the Universal Dock Mount and the "above water" parts are mounted to the dock or piling.
- Due to shipping limitations, a 1" pipe extension needs to be supplied by the purchaser to connect the "underwater parts" and "above water" parts.

Order No.	Mfg. No. / Description	List Price	
200277	(243485)	\$258.69	D0-5960200

Kasco Propellers



Order No.	Mfg. No. / Description	List Price	
200299	(240175) For 2400 De-Icer	\$29.19	EO-9812000
200311	(340130) For 3400 De-Icer	\$38.59	EO-4982000
200322	(440405) For 4400 De-Icer	\$66.59	EO-4994000

Kasco De-Icer Control Panel



- The C-20 time and temperature controller allows you to determine at what air temperature and time of day the de-icer turns on by using both an air temperature controller and timer clock.
- One C-20 will control one 120V de-icer.

Order No.	Mfg. No. / Description	List Price	
200244	(120350)	\$211.49	D0-9196100

Kasco Twist Lock Plug



- 30 amp twist lock plugs are offered by Kasco for their electrical power cable.

Order No.	Mfg. No. / Description	List Price	
200255	(243480)	\$71.99	EO-9935000

Buck-Algonquin Bronze Packing Boxes



- Cast bronze plain finish.
- Self Aligning. Gland Type.
- Complete with hose, clamps, a packing gland and two nuts for per stud.

Order No.	Mfg. No.	Shaft Size	Hose ID	List Price	
265138	(00PB125G)	1-1/4"	2-1/4"	\$341.09	H0-5640200
265151	(00PB150G)	1-1/2"	2-1/2"	\$315.69	H0-1498100
265164	(00PB175G)	1-3/4"	3"	\$537.39	H0-3422300
265177	(00PB200G)	2"	3"	\$522.09	H0-5231300
265187	(1554)	2"	3-1/2"	\$443.89	G0-1479200
265190	(00PB225G)	2-1/4"	3-1/2"	\$526.89	H0-3161300
265203	(00PB250G)	2-1/2"	3-1/2"	\$497.49	H0-9489200

Buck-Algonquin Bronze Rudder Ports



- Cast bronze plain finish.
- Inside mount. Square flange.
- Complete with packing nut and lock nut.

Order No.	Shaft	Flange	Length	List Price	
261557	1"	3-7/8" x 3-7/8"	4"	\$233.39	H0-3004100
261583	1-1/4"	4-1/4" x 4-1/4"	4"	\$364.39	H0-3681200
261610	1-1/2"	4-1/2" x 4-1/2"	5"	\$570.59	H0-5324300
261646	1-1/2"	3-3/4" x 7"	5"	\$517.49	H0-9401300
261658	1-3/4"	4-1/8" x 7-1/8"	5"	\$635.39	G0-1752400
261660	2"	4-1/8" x 7-1/8"	5"	\$765.59	H0-5395400

Buck-Algonquin Bronze Rudder Collars



- Each collar comes complete with a setscrew.

Order No.	Mfg. No.	Shaft Size	Outside Dia.	Overall Height	List Price	
261153	(00RC100)	1"	1-3/4"	1"	\$48.79	H0-7292000
261177	(00RC125)	1-1/4"	2"	1"	\$54.59	H0-5723000
261191	(00RC150)	1-1/2"	2-5/16"	1-13/16"	\$50.19	H0-1103000
261204	(00RC175)	1-3/4"	2-11/16"	1-11/16"	\$125.59	H0-5357000
261216	(00RC200)	2"	2-15/16"	1-5/8"	\$75.39	G0-1505000

Buck-Algonquin Bronze Tiller Arms



- Complete with pinch bolt, nut and a setscrew.

Order No.	Mfg. No.	Shaft Size	Overall Length	List Price	
261305	(10TA10X700)	1"	9-1/4"	\$113.09	H0-5876000
261331	(10TA12X700)	1-1/4"	9-1/4"	\$103.99	G0-7696000
261343	(10TA12X900)	1-1/4"	11-1/2"	\$167.29	H0-7300100
261367	(10TA15X100)	1-1/2"	15-3/4"	\$251.69	H0-1015100
261379	(10TA17X100)	1-3/4"	15-3/4"	\$235.79	H0-7414100
261381	(10TA20X100)	2"	15-3/4"	\$345.69	H0-1470200

Buck-Algonquin Bronze Packing Boxes



- Cast bronze plain finish.
- Self Aligning.
- Spud Type.
- Right hand thread.
- Complete with hose, stainless steel clamps, packing nut and lock nut.

Order No.	Mfg. No.	Shaft Size	Hose ID	List Price	
265024	(00PB100)	1"	1-3/4"	\$111.49	G0-0747000
265047	(00PB125)	1-1/4"	2-1/4"	\$202.79	H0-7612100
265073	(00PB150)	1-1/2"	2-1/2"	\$225.59	H0-5353100
265086	(00PB175)	1-3/4"	3"	\$372.69	H0-1632200
265099	(00PB200)	2"	3"	\$435.49	H0-9216200

Buck-Algonquin "Tournament" Bronze Rudder Port



- Cast bronze plain finish.
- Inside mount.
- Square flange.
- Complete with packing nut and lock nut.

Order No.	Mfg. No.	Shaft	Flange	Length	List Price	
261569	(2902)	1-1/4"	4" x 4"	3-1/2"	\$246.19	G0-5946100

Centek Industries Shaft Log



- Centek shaft logs (rudder post housings) are filament wound using only neat vinyl ester resin and corrosion resistant E glass fibers to ensure maximum performance.
- Smooth, resin-rich inner diameters ensure precision functionality.
- Sold in 10' lengths.

Order No.	Mfg. No. / Description	Price Per Ft.	
675225	(1100216) 2.49" ID, 3.00" OD x 120"	\$52.49	G0-7153000

- Electronics
- Trolling Motors
- Instruments
- Electrical
- Lighting
- Anchor & Dock
- Safety
- Steering, Controls
- Pumps
- Fuel System
- Seating & Pedestals
- Trailering
- Tops & Covers
- Perform.
- Propellers
- Engine & Care
- Cleaning & Care**
- Paint & Paint Acc.
- Fun & Flotation
- Topside Acc.
- Cockpit & Deck
- Hardware, Fasteners
- Camouflage
- Misc.
- Comm.

Square Flax Packing



Order No.	Mfg. No.	Length	List Price
379912	(10002) 3/16"	22" - 24"	\$4.59 HO-5720000
379924	(10003) 1/4"	22" - 24"	\$5.49 HO-9230000
379936	(10004) 5/16"	22" - 24"	\$6.69 HO-1040000
379948	(10005) 3/8"	22" - 24"	\$8.29 HO-7940000

TEN POUND BOX - #2

Order No.	Description	List Price
380054	3/16" Approx. 55.50'	\$132.19 HO-1397000
380042	1/4" Approx. 32'	\$132.19 HO-1397000
380066	5/16" Approx. 20.41'	\$132.19 HO-1397000
380078	3/8" Approx. 14.22'	\$132.19 HO-1397000
380082	1/2" Approx. 8'	\$132.19 HO-1397000
380106	5/8" Approx. 5.12'	\$132.19 HO-1397000
380117	3/4" Approx. 3.55'	\$132.19 HO-1397000
380129	7/8" Approx. 2.61'	\$132.19 HO-1397000
380131	1" Approx. 2'	\$132.19 HO-1397000
380143	1-1/8"	\$132.19 HO-1397000

TWENTY-FIVE POUND BOX - #2

Order No.	Description	List Price
380159	1-1/4"	\$330.49 HO-9289100

GFO® Packing



- Recommended for: All corrosive applications suitable for PTFE and graphite.
- Service Conditions: Shaft speeds to 4400 FPM; temperatures to 550° F/287° C; pH range 0-14.
- Equipment: All reciprocating and rotating shafts.
- Construction: Multi-Lok Braid.
- Features: Finely ground particles of the highest quality graphite in a PTFE matrix to control graphite migration. 100% GFO Yarn.

Order No.	Mfg. No. / Description	List Price
318279	(ML4002 3/4") 3/4" 10# Box, Approx. 27.9'	\$845.39 CO-8581700
318293	(ML4002 7/8") 7/8" 10# Box, Approx. 21'	\$845.39 CO-8581700

Teflon (PTFE) Flax Packing



- PTFE Flax packing is braided from quality flax rovings which are then impregnated with TEFLON (PTFE).
- The result is a quality packing that offers high performance and extended packing life.

Order No.	Mfg. No. / Description	List Price
380169	(10016) 3/16" x 2'	\$6.39 HO-3830000
380170	(10017) 1/4" x 2'	\$6.19 HO-1730000
380171	(10018) 5/16" x 2'	\$9.89 HO-3950000
380172	(10019) 3/8" x 2'	\$12.09 HO-5270000
380173	(10021) 1/2" x 2'	\$17.89 HO-3701000

Teflon (PTFE) Flax Packing - Spools



- This popular shaft packing is a blend of quality flax rovings that are braided to a high quality standard.
- The braid is then impregnated with TEFLON (PTFE) to give it a low surface friction.
- This combination results in a packing that delivers solid performance, season after season.

ONE POUND SPOOLS

Order No.	Mfg. No. / Description	List Price
380178	(10102) 1/4" Approx. 30.6'	\$49.29 HO-7592000
380179	(10103) 5/16" Approx. 17.2'	\$49.29 HO-7592000
380180	(10104) 3/8" Approx. 11'	\$49.29 HO-7592000

TEN POUND SPOOLS

Order No.	Mfg. No. / Description	List Price
380183	(10315) 1/2" Approx. 73.9'	\$444.59 HO-5766200
380185	(10317) 3/4" Approx. 27.6'	\$408.89 HO-3354200
380186	(10318) 7/8" Approx. 22.8'	\$444.59 HO-5766200
380187	(10319) 1" Approx. 17.6'	\$396.69 HO-1083200

Duramax® Ultra-X® High Performance Compression Packing

DURAMAX MARINE



- Dissipates frictional heat - Over five times more thermally conductive than flax and PTFE.
- Grease-free installation - Self-lubricating and conformable, easy to install and remove after use.
- Virtually eliminates shaft scoring - Stays pliable, never hardens or becomes abrasive, even at high shaft speeds.
- Leakage practically eliminated - Doesn't shrink, keeps bilge drier and free of oily contaminants.
- Lasts over 5 times longer than other packing.

Order No.	Mfg. No. / Description	List Price
428810	(X-5/8") 5/8" 10# Box	\$789.69 CO-4217600
428815	(X-3/4") 3/4" 10# Box	\$789.69 CO-4217600
428820	(X-7/8") 7/8" 10# Box	\$789.69 CO-4217600
428825	(X-1") 1" 10# Box	\$789.69 CO-4217600



Packing Extractor Tools - Flexible Shaft



- Manufactured with quality steel.
- Each shaft is flexible spiral wound steel to provide maximum flexibility in the removal of old packing.
- The hook tips are heat treated for maximum strength.

Order No.	Mfg. No. / Description	Hook Size	List Price	
261812	(10160) Shaft Length 13"	Hook Size 5/16"	\$15.19	H0-1190000
261824	(10161) Shaft Length 9"	Hook Size 7/16"	\$22.19	H0-1331000
261836	(10162) Shaft Length 9"	Hook Size 1/2"	\$28.69	H0-1271000



PSS (Packless Sealing System) Shaft Seals



Additional Sizes Available. Call for Pricing and Availability

- The PSS Shaft Seal is a mechanical face seal that is created between the flat surfaces of the rotating stainless steel rotor and the stationary carbon flange.
- The stationary carbon flange is attached to the vessels stern tube with hose clamps and the carbon flange is attached to the front side of the bellows with hose clamps.
- The stainless steel rotor is fit on the shaft in front of the carbon flange. It is used to compress the bellows before the collar is secured to the shaft with set-screws. This compression (pre-load) maintains contact between the faces and allows the PSS to compensate for the thrust from the propeller.
- The carbon flange is bored larger than the shaft diameter allowing it to "float" around the shaft and thus compensate for most misalignment and vibration problems.
- The stainless steel collar is sealed to the shaft by two o-rings that are recessed into the bore of the collar. These o-rings rotate with the shaft and stainless steel rotor and do not experience wear during operation.

Order No.	Mfg. No.	Shaft Dia.	Stern Tube Outside Dia.	List Price	
032190	(02-138-212)	1-3/8"	2-1/2"	\$340.00	Z0-0027200
032186	(02-134-300)	1-3/4"	3"	\$515.00	Z0-0021400
032188	(02-134-312)	1-3/4"	3-1/2"	\$515.00	Z0-0021400
032192	(02-200-312)	2"	3-1/2"	\$605.00	Z0-0048400
032277	(02-214-312)	2-1/4"	3-1/2"	\$690.00	Z0-0025500
032275	(02-212-400)	2-1/2"	4"	\$690.00	Z0-0025500
032279	(02-300-412)	3"	4-1/2"	\$985.00	Z0-0088700

Shaft Seal Air Control



- Totally enclosed.
- Protected from the elements.
- Vacuum generator built-in.
- Regulates boat air line pressures as high as 250 psi, down to a usable 0 to 70 psi.
- Consists of a regulator 0-100 psi, vacuum generator, control valves for flow in and out, gauge for set pressure, VAC-PRESS gauge for line out pressure/vacuum, handle for carrying and for switch/valve protection, quick connect fitting for boat air hose, hose 11 foot long, to shaft seal emergency air bladder connection.
- Self test plug on bottom.
- 2 Vacuum buttons, intentional 2 hand operation to eliminate accidental switching.

Order No.	Mfg. No. / Description	List Price	
325207	(EAC-101-PV-E)	\$953.10	A0-0135900

Electronics

Trolling Motors

Instruments

Electrical

Lighting

Anchor & Dock

Safety

Steering, Controls

Pumps

Fuel System

Seating & Pedestals

Trailer

Tops & Covers

Perform.

Propellers

Engine & Care

Cleaning & Care

Paint & Paint Acc.

Fun & Flotation

Topside Acc.

Cockpit & Deck

Hardware, Fasteners

Camouflage

Misc.

Comm.



DuraBlue® Self-Lubricating Rudder Bushings and Sheet Stock

DURABLE BEARINGS AND SHEETS ARE:

- Greaseless, self-lubricating and pollution free.
- Dimensionally stable with extremely long life.
- High load capability & ultra low friction.
- All DuraBlue Composite Bushings and Sheets are rated for continuous duty and extremely smooth operation with specific pressure up to 25N/mm².

DURABLE RUDDER BEARINGS

- All standard size rudder bearings shown are carried in-stock at our regional warehouses and manufacturing facility in Hiram, Ohio. Any size not shown can be made to order. 1" - 42" Inside Diameter range.

DURABLE SHEET STOCK

- For fabrication of Thrust Washers, Wear Pads and Skid Plates.

DuraBlue Unfinished Tube Stock

DuraBlue Sheet Stock

DuraBlue Finished Thrust Washers

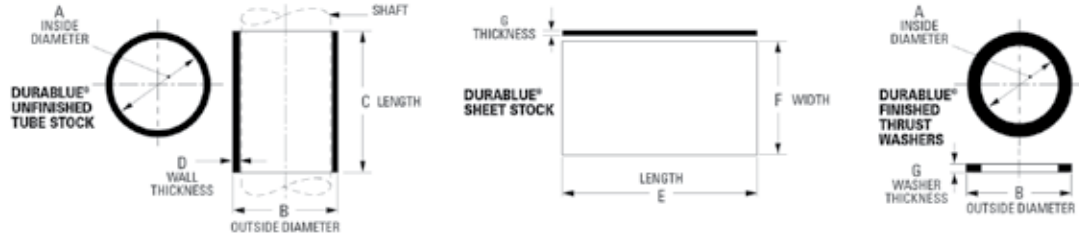

DURABLE UNFINISHED TUBE STOCK

Order No.	Code	A - Inside Diameter		B - Outside Diameter		C - Length		D - Wall Thickness		Approx. Wt.		List Price
		inch	mm	inch	mm	inch	mm	inch	mm	lbs.	kg.	
	(AGE)	1.00	25	2.00	51	30.50	775	0.500	13	3.4	1.6	
	(AIM)	1.00	25	2.50	51	30.50	775	0.750	19	6.2	2.8	
427810	(AIR)	1.00	25	3.00	76	30.50	775	1.000	25	9.3	4.2	\$969.39 L0-0748400
427820	(ALE)	1.00	25	3.50	89	30.50	775	1.250	32	13.1	5.9	\$1,368.99 L0-0548600
	(ARC)	1.00	25	5.00	127	30.50	775	2.000	51	27.8	12.6	
427815	(ARM)	1.75	44	4.25	108	30.50	775	1.250	32	17.4	7.9	\$1,633.59 C0-5588310
427841	(BAT)	2.00	51	5.00	127	30.50	775	1.500	38	24.3	11.0	\$2,276.19 C0-6743910
	(BOX)	2.75	70	5.25	133	30.50	775	1.250	32	22.9	10.4	
	(CAN)	3.50	89	6.75	171	30.50	775	1.625	41	37.0	16.8	
427844	(COG)	3.75	95	6.25	159	30.50	775	1.250	32	35.0	15.9	\$2,689.29 L0-5644310
	(DEW)	4.00	102	7.00	178	30.50	775	1.500	38	38.0	17.2	
427848	(DOT)	4.75	121	7.25	184	30.50	775	1.250	32	34.7	15.7	\$3,299.49 L0-5794610
	(ECO)	5.25	133	8.25	210	30.50	775	1.500	38	47.4	21.5	
427864	(ELK)	5.75	146	8.25	210	30.50	775	1.250	32	40.5	18.4	\$3,831.39 L0-0751910
427868	(ELM)	5.75	146	9.25	235	30.50	775	1.750	44	60.8	27.5	\$5,710.59 L0-0355820
427872	(FOX)	6.75	171	9.25	235	30.50	775	1.250	32	46.3	21.0	\$4,363.29 L0-5618120
427876	(GAL)	7.00	178	10.50	267	30.50	775	1.750	44	70.9	32.1	\$6,598.89 L0-5499230
	(GAP)	7.75	197	10.25	260	20.50	521	1.250	32	34.4	15.6	
427880	(GEM)	7.75	197	10.25	260	30.50	775	1.250	32	52.1	23.6	\$4,900.59 L0-0305420
	(HAT)	8.25	210	10.75	273	30.50	775	1.250	32	54.6	24.7	
427884	(HUB)	8.75	222	11.25	286	30.50	775	1.250	32	57.9	26.2	\$5,432.49 L0-5261720
	(INN)	9.25	235	12.50	318	30.50	775	1.625	41	82.3	37.3	
	(ION)	9.75	248	12.25	311	30.50	775	1.250	32	62.6	28.4	
427822	(IVY)	9.75	248	13.00	330	20.50	521	1.625	41	57.3	27.0	\$5,078.79 L0-0493520
427823	(JAB)	10.00	254	13.00	330	30.50	775	1.500	38	79.6	36.0	\$7,470.99 L0-0553730
	(JIG)	10.75	273	13.75	349	20.50	521	1.500	38	56.3	25.5	
427824	(JUG)	10.75	273	13.75	349	30.50	775	1.500	38	84.8	38.4	\$7,956.99 L0-0587930
427829	(KAS)	11.00	279	14.00	356	20.50	521	1.500	38	58.1	27.4	\$5,154.39 L0-0277520
427831	(KEG)	11.50	292	14.00	356	20.50	521	1.250	32	49.4	23.3	\$4,376.79 L0-0488120
	(KEY)	11.75	298	14.75	375	20.50	521	1.500	38	60.9	27.6	
427828	(KIT)	11.75	298	14.75	375	30.50	775	1.500	38	92.9	42.1	\$8,556.39 L0-0287240
	(LID)	12.75	324	16.25	413	20.50	521	1.750	44	77.7	35.2	
427832	(LOG)	12.75	324	16.25	413	30.50	775	1.750	44	117.6	53.3	\$11,045.79 L0-0922550
	(MOP)	13.75	349	17.25	438	20.50	521	1.750	44	83.0	37.6	
427836	(MUG)	13.75	349	17.25	438	30.50	775	1.750	44	123.5	55.9	\$11,677.59 L0-0883850
	(NAB)	14.75	375	18.25	464	20.50	521	1.750	44	88.4	40.0	
427878	(NAP)	14.00	356	17.50	445	20.50	521	1.750	44	84.3	39.7	\$7,581.69 L0-5809730
427839	(NOD)	14.75	375	18.25	464	30.50	775	1.750	44	131.5	59.6	\$12,433.59 L0-0861260

DURABLE SHEET STOCK

Order No.	Code	E - Sheet Length		F - Sheet Width		G - Sheet Thickness		Approx. Wt.		List Price
		inch	mm	inch	mm	inch	mm	lbs.	kg.	
	(SAW)	48.50	1232	20.50	521	0.50	12.70	24.0	10.9	
427852	(SAT)	48.50	1232	30.50	775	0.50	12.70	36.0	16.3	\$2,710.89 L0-5455310
	(SKY)	48.50	1232	20.50	521	0.75	19.05	36.0	16.3	
427856	(SEA)	48.50	1232	30.50	775	0.75	19.05	57.0	25.9	\$4,109.49 L0-5745020
	(SUN)	48.50	1232	20.50	521	1.00	25.40	47.0	21.3	
427860	(SOX)	48.50	1232	30.50	775	1.00	25.40	70.0	31.8	\$5,475.69 L0-5873720

DURABLE FINISHED THRUST WASHERS

Order No.	Code	A - Inside Diameter		B - Outside Diameter		G - Washer Thickness	
		inch	mm	inch	mm	inch	mm
	(TOW)	6.063	154.00	12.000	304.80	0.500	12.70
	(TUG)	7.063	179.40	14.000	355.60	0.500	12.70
	(TUX)	8.063	204.80	13.250	336.55	0.625	15.88

Johnson Cutless® Naval Brass Sleeve Bearings

- These bearings adapt equally well to strut and stern tube mounts, and are often used effectively as rudder-stock and pintle bushings.
- Bearing diameters are precision fitted to the designated shaft size with the correct clearance for efficient water lubrication.
- External brass shells are machined and polished to provide easy fitting.
- Specially formulated oil and chemical resistant nitrile rubber is securely bonded to the shell.
- Units with thin shells are available for the struts of small craft.
- Sleeve bearings are usually installed by light press-fitting and locked in place with cone-pointed set screws.
- PRECAUTION: When shrink fitting of the bearing is required, chilling must be achieved by gradual cooling to not more than minus 20° F (-28° C) using freezer or regular ice (DO NOT DRY ICE). NOTE: Pounding or shocking the bearing while in the chilled state could cause the rubber to separate from the shell.

DURAMAX MARINE^{INC.}



Order No.	Mfg. No.	Shaft Size	OD	Length	List Price	
426230	(ABLE)	3/4"	1-1/4"	3"	\$74.29	HO-7544000
426254	(APEX)	7/8"	1-3/8"	3-1/2"	\$79.39	HO-3674000
426278	(BACK)	1"	1-1/4"	4"	\$77.69	HO-1664000
426280	(BAIT)	1"	1-3/8"	4"	\$82.09	HO-5294000
426292	(BALE)	1"	1-1/2"	4"	\$80.39	HO-3284000
426305	(BAND)	1"	1-5/8"	4"	\$81.79	HO-7094000
426317	(BASE)	1"	2"	4"	\$102.99	HO-9716000
426329	(BEAM)	1-1/8"	1-1/2"	4-1/2"	\$101.79	HO-7016000
426343	(BEND)	1-1/8"	1-3/4"	4-1/2"	\$107.09	HO-5246000
426355	(BILL)	1-1/8"	2"	4-1/2"	\$114.09	HO-5486000
426367	(BIND)	1-1/4"	1-1/2"	5"	\$102.99	HO-9716000
426379	(BIRD)	1-1/4"	1-3/4"	5"	\$103.89	HO-3326000
426381	(BITE)	1-1/4"	2"	5"	\$108.79	HO-7256000
426393	(BLOW)	1-1/4"	2-1/8"	5"	\$119.89	HO-3917000
426406	(BOAT)	1-3/8"	1-7/8"	5-1/2"	\$115.69	HO-1496000
426418	(BOLD)	1-3/8"	2"	5-1/2"	\$125.79	HO-7457000
426420	(BOOT)	1-3/8"	2-3/8"	5-1/2"	\$138.49	HO-9038000
426432	(BOSS)	1-1/2"	2"	6"	\$143.49	HO-9068000
426444	(BRAD)	1-1/2"	2-3/8"	6"	\$151.59	HO-5909000
426468	(BROW)	1-3/4"	2-3/8"	7"	\$176.79	HO-7060100
426470	(BUCK)	1-3/4"	2-5/8"	7"	\$180.69	HO-1480100
426494	(CALL)	2"	2-5/8"	8"	\$200.99	HO-9502100

Order No.	Mfg. No.	Shaft Size	OD	Length	List Price	
426507	(CALM)	2"	3"	8"	\$205.89	HO-3532100
426519	(CARE)	2-1/4"	2-15/16"	9"	\$250.49	HO-9205100
426521	(CART)	2-1/4"	3-1/8"	9"	\$260.99	HO-9565100
426557	(CORD)	2-1/2"	3-1/8"	10"	\$307.69	HO-1648100
426569	(CORN)	2-1/2"	3-3/8"	10"	\$309.59	HO-5758100
426571	(CROW)	2-3/4"	3-3/8"	11"	\$358.89	HO-3351200
426583	(CURD)	2-3/4"	3-3/4"	11"	\$377.19	HO-1362200
426595	(DANE)	3"	3-3/4"	12"	\$382.19	HO-1392200
426608	(DARE)	3"	4"	12"	\$394.19	HO-1563200
426646	(DINE)	3-1/2"	4-1/4"	14"	\$471.09	HO-5628200
426658	(DOCK)	3-1/2"	4-1/2"	14"	\$474.99	HO-9948200
426660	(DOLE)	3-5/8"	4-1/2"	14-1/2"	\$531.59	HO-5981300
426696	(EARN)	4"	5"	16"	\$726.99	HO-9163400
426709	(EASE)	4"	5-1/4"	16"	\$782.99	HO-9796400
426723	(EPIC)	4-1/2"	5-1/2"	18"	\$930.99	HO-9585500
426735	(EDGE)	4-1/2"	5-3/4"	18"	\$993.49	HO-9069500
426759	(FACE)	5"	6-1/8"	20"	\$1,333.19	HO-1999700
426761	(FACT)	5"	6-1/2"	20"	\$1,433.59	HO-5106800
426800	(FIND)	5-1/2"	7"	22"	\$1,862.19	HO-1371110
426812	(FORK)	5-3/4"	7"	23"	\$1,977.29	HO-7368110
426824	(GALE)	6"	7-1/2"	24"	\$2,080.19	HO-1184210

Johnson Cutless® Non-Metallic Sleeve Bearings

- These bearings feature a dense structure of engineered reinforced thermoset plastic.
- The specially compounded Nitrile Rubber is securely bonded to the shell with all tolerances maintained for proper lubrication.
- Being non-corrosive and inherently resistant to all known chemicals, oil and grease, as well as being anti-electrolytic, the Johnson Cutless Non-Metallic Sleeve Bearings are ideally suited for installations wherever corrosion or electrolysis is a problem.
- PRECAUTION: When shrink fitting of the bearing is required, chilling must be achieved by gradual cooling to not more than minus 20° F (-28° C) using freezer or regular ice (DO NOT DRY ICE). NOTE: Pounding or shocking the bearing while in the chilled state could cause the rubber to separate from the shell.
- All other standard sizes available upon request.

DURAMAX MARINE^{INC.}



Order No.	Mfg. No.	Shaft Size	OD	Length	List Price	
427105	(BETTY)	1"	1-1/2"	4"	\$77.99	HO-9764000
427143	(DELLA)	1-1/4"	1-3/4"	5"	\$108.59	HO-5156000
427167	(DORIS)	1-1/4"	2"	5"	\$106.09	HO-5636000
427179	(DOTTY)	1-1/4"	2-1/8"	5"	\$125.29	HO-7157000
427206	(EVA)	1-1/2"	2"	6"	\$138.59	HO-5138000
427218	(FANNY)	1-1/2"	2-3/8"	6"	\$146.89	HO-3188000
427232	(GLENDA)	1-3/4"	2-3/8"	7"	\$169.09	HO-5410100
427244	(GLORIA)	1-3/4"	2-5/8"	7"	\$172.69	HO-1630100
427268	(HAZEL)	2"	2-5/8"	8"	\$196.79	HO-7081100

Order No.	Mfg. No.	Shaft Size	OD	Length	List Price	
427270	(HELEN)	2"	3"	8"	\$201.19	HO-1702100
427307	(INEZ)	2-1/4"	2-15/16"	9"	\$244.79	HO-7864100
427319	(INGRID)	2-1/4"	3-1/8"	9"	\$255.09	HO-5035100
427345	(JOAN)	2-1/2"	3-1/8"	10"	\$292.29	HO-7357100
427357	(JOSIE)	2-1/2"	3-3/8"	10"	\$302.59	HO-5518100
427383	(KIM)	3"	3-3/4"	12"	\$380.99	HO-9582200
427395	(LAURA)	3"	4"	12"	\$391.99	HO-9153200
427446	(MARIE)	3-1/2"	4-1/2"	14"	\$506.99	LO-0535200



SPECIAL HANDLING MAY APPLY



Cleaning & Care

- Electronics
- Trolling Motors
- Instruments
- Electrical
- Lighting
- Anchor & Dock
- Safety
- Steering, Controls
- Pumps
- Fuel System
- Seating & Pedestals
- Trailering
- Tops & Covers
- Perform.
- Propellers
- Engine & Care
- Cleaning & Care
- Paint & Paint Acc.
- Fun & Flotation
- Topside Acc.
- Cockpit & Deck
- Hardware, Fasteners
- Camouflage
- Misc.
- Comm.



Johnson Cutless® Sleeve Bearing Specifications Chart

DURAMAX MARINE^{LLC}

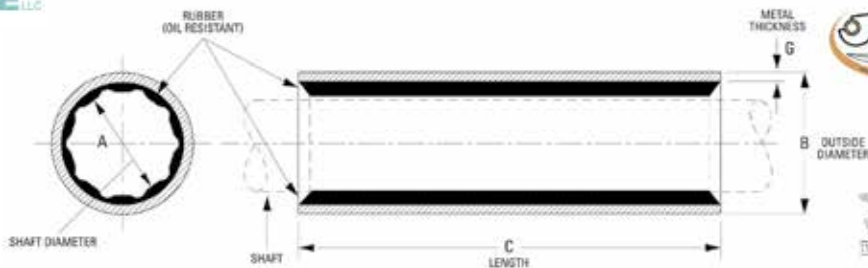

(A) Shaft or Sleeve Size	(B) Outside Diameter	(C) Length	(G) Wall Thick	Metallic Shell	Non-Metallic Shell
3/4"	1-1/4"	3"	1/8"	426230 (ABLE)	ALDA
7/8"	1-1/4"	3-1/2"	1/16"	ACID	ALICE
7/8"	1-3/8"	3-1/2"	1/8"	426254 (APEX)	ANNE
7/8"	1-1/2"	3-1/2"	1/8"	ATOM	ARDELE
1"	1-1/4"	4"	1/16"	426278 (BACK)	BABE
1"	1-1/4"	6"	1/16"	BADE	—
1"	1-3/8"	4"	1/16"	426280 (BAIT)	BECKY
1"	1-1/2"	4"	1/8"	426292 (BALE)	427105 (BETTY)
1"	1-5/8"	4"	1/8"	426305 (BAND)	CANDY
1"	2"	4"	1/8"	426317 (BASE)	CARLA
1-1/8"	1-1/2"	4-1/2"	1/16"	426329 (BEAM)	CEIL
1-1/8"	1-5/8"	4-1/2"	1/8"	BELT	CINDY
1-1/8"	1-3/4"	4-1/2"	1/8"	426343 (BEND)	CONNIE
1-1/8"	2"	4-1/2"	1/8"	426355 (BILL)	CORA
1-1/4"	1-1/2"	5"	1/16"	426367 (BIND)	DEENA
1-1/4"	1-3/4"	5"	1/8"	426379 (BIRD)	427143 (DELLA)
1-1/4"	2"	5"	1/8"	426381 (BITE)	427167 (DORIS)
1-1/4"	2-1/8"	5"	1/8"	426393 (BLOW)	427179 (DOTTY)
1-3/8"	1-7/8"	5-1/2"	1/8"	426406 (BOAT)	EDNA
1-3/8"	2"	5-1/2"	1/8"	426418 (BOLD)	ELLEN
1-3/8"	2-3/8"	5-1/2"	1/8"	426420 (BOOT)	ERMA
1-1/2"	2"	6"	1/8"	426432 (BOSS)	427206 (EVA)
1-1/2"	2-3/8"	6"	1/8"	426444 (BRAD)	427218 (FANNY)
1-5/8"	2-5/8"	6-1/2"	1/8"	BRIM	FRAN
1-3/4"	2-3/8"	7"	1/8"	426468 (BROW)	427232 (GLENDA)
1-3/4"	2-5/8"	7"	1/8"	426470 (BUCK)	427244 (GLORIA)
1-7/8"	2-15/16"	7-1/2"	3/32"	BULL	HANNA
2"	2-5/8"	8"	1/8"	426494 (CALL)	427268 (HAZEL)
2"	2-3/4"	8"	1/8"	CAMP	—
2"	3"	8"	1/8"	426507 (CALM)	427270 (HELEN)
2-1/8"	2-15/16"	8-1/2"	1/8"	CAME	HILDA
2-1/4"	2-15/16"	9"	3/32"	426519 (CARE)	427307 (INEZ)
2-1/4"	3-1/8"	9"	1/8"	426521 (CART)	427319 (INGRID)
2-3/8"	3-3/8"	9-1/2"	1/8"	COOK	JENNY
2-1/2"	3-3/8"	10"	1/8"	426569 (CORN)	427357 (JOSIE)

(A) Shaft or Sleeve Size	(B) Outside Diameter	(C) Length	(G) Wall Thick	Metallic Shell	Non-Metallic Shell
2-5/8"	3-3/8"	10-1/2"	1/8"	CRAB	JOYCE
2-3/4"	3-3/8"	11"	1/8"	426571 (CROW)	JUNE
2-3/4"	3-1/2"	11"	5/32"	CUBE	—
2-3/4"	3-3/4"	11"	1/8"	426583 (CURD)	KATHY
2-7/8"	3-3/4"	11-1/2"	1/8"	CURE	KELLY
3"	3-3/4"	12"	1/8"	426595 (DANE)	427383 (KIM)
3"	4"	12"	1/8"	426608 (DARE)	427395 (LAURA)
3-1/4"	4"	13"	1/8"	DARN	LINDA
3-3/8"	4-1/2"	13-1/2"	1/8"	DIKE	LOIS
3-1/2"	4-1/4"	14"	1/8"	426646 (DINE)	MANDY
3-1/2"	4-1/2"	14"	1/8"	426658 (DOCK)	427446 (MARIE)
3-5/8"	4-1/2"	14-1/2"	1/8"	426660 (DOLE)	MARTHA
3-3/4"	4-1/2"	15"	1/8"	DONE	MARY
3-3/4"	5-1/4"	15"	3/16"	DRAW	NEVA
3-7/8"	5-1/4"	15-1/2"	3/16"	DULL	NORA
4"	5"	16"	3/16"	426696 (EARN)	OLGA
4"	5-1/4"	16"	3/16"	426709 (EASE)	OLIVE
4-1/8"	5-1/4"	16-1/2"	3/16"	ECHO	OPAL
4-1/4"	5-1/2"	17"	3/16"	EDIT	PAM
4-3/8"	5-3/4"	17-1/2"	3/16"	ELSE	PANSY
4-1/2"	5-1/2"	18"	3/16"	426723 (EPIC)	PAULA
4-1/2"	5-3/4"	18"	3/16"	426735 (EDGE)	PENNY
4-5/8"	6-1/8"	18-1/2"	1/4"	EVEN	RHODA
4-3/4"	6-1/8"	19"	1/4"	EVER	RINA
4-7/8"	6-1/8"	19-1/2"	1/4"	EVIL	ROSE
5"	6-1/8"	20"	1/4"	426759 (FACE)	RUTH
5"	6-1/2"	20"	1/4"	426761 (FACT)	SALLY
5-1/4"	6-3/4"	21"	1/4"	FADE	SANDRA
5-1/4"	7"	21"	1/4"	FARE	SARAN
5-3/8"	6-3/4"	21-1/2"	1/4"	FEAR	SUSAN
5-3/8"	7"	21-1/2"	1/4"	FELT	TONI
5-1/2"	7"	22"	1/4"	426800 (FIND)	TRICIA
5-5/8"	7"	22-1/2"	1/4"	FLAT	VERA
5-3/4"	7"	23"	1/4"	426812 (FORK)	WANDA
5-7/8"	7-1/2"	24"	1/4"	FUEL	WINNIE
6"	7-1/2"	24"	1/4"	426824 (GALE)	ZELDA
6-1/2"	8-3/8"	30"	7/16"	GOLD	—

- Electronics
- Trolling Motors
- Instruments
- Electrical
- Lighting
- Anchor & Dock
- Safety
- Steering, Controls
- Pumps
- Fuel System
- Seating & Pedestals
- Trailering
- Tops & Covers
- Perform.
- Propellers
- Engine & Care
- Cleaning & Care
- Paint & Paint Acc.
- Fun & Flotation
- Topside Acc.
- Cockpit & Deck
- Hardware, Fasteners
- Camouflage
- Misc.
- Comm.

Duramax Marine Stern Tube Clamp Adapter

DURAMAX MARINE^{LLC}



- Shaft diameter 1" thru 1-3/4".
- Stern tube diameter 2-1/2".

Order No. **473047** Mfg. No. / Description (SXU-1000-250)

List Price **\$121.96** E0-7419000



Freshwater Exclusive



Saltwater Exclusive

Flanged Bearings

1055

Johnson Cutless® Flanged Bearings

DURAMAX MARINE^{LLC}

- Johnson Cutless Flanged Bearings are centrifugally cast naval brass with an integral flange for bolting to stern tube or strut housing to retain bearing and prevent rotation in housing.
- Specially formulated oil and chemical resistant nitrile rubber is securely bonded to the shell.
- Shells are heavy walled providing structural strength and can be step turned if desired.
- Flanges are furnished UN-DRILLED unless specified.
- PRECAUTION: When shrink fitting of the bearing is required, chilling must be achieved by gradual cooling to not more than minus 20° F (-28° C) using freezer or regular ice (DO NOT DRY ICE).
- NOTE: Pounding or shocking the bearing while in the chilled state could cause the rubber to separate from the shell.
- Approved Bearings: Johnson Cutless Naval Brass Flanged Bearings meet military specification MIL-B-17901 (Ships) Class II Full-Molded type and have full type approval from The American Bureau of Shipping.

Order No.	Mfg. No.	Shaft Size	OD	List Price	Order No.	Mfg. No.	Shaft Size	OD	List Price		
427561	(860762100)	Catch 3"	4-1/4"	\$1,436.09	D0-7884110	427763	(862042101)	Heart 8"	10-1/4"	\$3,230.19	C3-9103230
427585	(860892101)	Clear 3-1/2"	4-7/8"	\$2,299.59	H0-5797310	427787	(862042102)	Hedge 8"	10-1/2"	\$4,215.19	C3-9151240
427600	(861022100)	Draft 4"	5-1/2"	\$2,315.79	H0-7498310	427640	(862172100)	Hoist 8-1/2"	10-3/4"	\$4,457.29	C3-9275440
427636	(861152100)	Drink 4-1/2"	6"	\$1,727.89	C3-9872710	427838	(862232100)	Hover 8-3/4"	11"	\$4,396.99	C0-4473730
427650	(861272100)	Earth 5"	6-3/4"	\$1,517.39	C3-9371510	427790	(862292100)	Infra 9"	11-1/4"	\$4,433.19	C3-9133440
427698	(861462100)	Event 5"	7-1/4"	\$2,195.59	C3-9559120	427789	(862292101)	Ideal 9"	11-1/2"	\$7,403.09	C0-7422950
427705	(861532101)	Fault 6"	7-3/4"	\$2,363.09	D0-7409810	427791	(862682100)	Jumbo 10-1/2"	12-7/8"	\$6,764.09	C3-9046760
427713	(861592100)	Fence 6-1/4"	8"	\$2,258.69	C3-9685220	427795	(862802100)	Knock 11"	13-1/2"	\$7,318.99	C3-9981370
427745	(861662100)	Flare 6-1/2"	8-3/8"	\$2,195.59	C3-9559120	427799	(826872100)	Kraft 11-1/4"	13-3/4"	\$7,227.29	C3-9272270
427749	(861722100)	Froze 6-3/4"	8-3/4"	\$3,760.99	C3-9906730	427804	(862932101)	Kneel 11-1/2"	14-1/8"	\$8,158.09	C3-9085180
427751	(861782100)	Gavel 7"	9"	\$2,442.19	C3-9124420	427809	(863062100)	Labor 12"	14-3/4"	\$8,433.29	C3-9233480
427750	(861782101)	Gland 7"	9-1/8"	\$3,333.99	C3-9933330	427813	(863222100)	Logic 12-5/8"	15-3/8"	\$11,559.69	C3-9695511
427753	(861912101)	Globe 7-1/2"	9-5/8"	\$3,009.09	C3-9090030	427817	(863312100)	Mince 13"	15-7/8"	\$15,692.09	C3-9029651
427754	(861972100)	Gipsy 7-3/4"	9-7/8"	\$3,350.49	C3-9405330	427821	(863822100)	Quiet 15"	18"	\$48,250.99	H0-9505982

Johnson Cutless® Flanged Bearing Specifications Chart

Code	(A) Shaft or Sleeve Size	(B) Outside Diameter	(C) Length	(D) Flange Diameter	(E) Flange Thickness	(F) Metal ID	(G) Metal Thickness	Special Instructions	Shipping Weight
BRACE	2"	3"	8"	5"	3/8"	2-5/8"	3/16"		7 lbs.
BROAD	2-1/2"	3-3/8"	10"	5-1/2"	3/8"	3-1/8"	1/8"		9 lbs.
CATCH	3"	4-1/4"	12"	6-3/4"	1/2"	3-3/4"	1/4"	DMI #427561	20 lbs.
CLAMP	3-1/4"	4-1/2"	13"	7"	1/2"	4"	1/4"		22 lbs.
CRANK	3-1/2"	4-3/4"	12-1/2"	6-3/4"	1/2"	4-1/4"	1/4"		21 lbs.
CLEAR	3-1/2"	4-7/8"	14"	7-3/8"	1/2"	4-1/4"	5/16"	DMI #427585	29 lbs.
CIVIL	3-3/4"	5-1/4"	15"	7-3/4"	1/2"	4-5/8"	5/16"		32 lbs.
DRAFT	4"	5-1/2"	16"	8"	1/2"	4-7/8"	5/16"	DMI #427600	36 lbs.
DREAD	4-1/4"	5-3/4"	17"	8-1/4"	1/2"	5-1/8"	5/16"		48 lbs.
DROLL	4-1/4"	5-3/4"	17"	8-1/4"	1/2"	5"	3/8"	Split on centerline	52 lbs.
DANCE	4-3/8"	6"	22"	8-7/8"	1/2"	5-3/8"	5/16"		64 lbs.
DRINK	4-1/2"	6"	18"	8-7/8"	1/2"	5-3/8"	5/16"	DMI #427636	56 lbs.
DROVE	4-3/4"	6-1/4"	19"	9-1/8"	1/2"	5-5/8"	5/16"		62 lbs.
EARTH	5"	6-3/4"	20"	9-5/8"	9/16"	6"	3/8"	DMI #427650	76 lbs.
EASEL	5-1/4"	6-7/8"	21"	9-7/8"	9/16"	6-1/8"	3/8"		81 lbs.
ERASE	5-1/2"	7-1/4"	22"	10-1/4"	9/16"	6-1/2"	3/8"		86 lbs.
EVENT	5-3/4"	7-1/4"	23"	10-1/4"	9/16"	6-1/2"	3/8"	DMI #427698	88 lbs.
FABLE	6"	7-3/4"	15"	12-1/4"	9/16"	6-1/2"	3/8"		75 lbs.
FAULT	6"	7-3/4"	24"	11"	9/16"	7"	3/8"	DMI #427705	101 lbs.
FAITH	6"	8-1/2"	20"	11-5/8"	5/8"	7"	3/4"	Split 1/16" above & below centerline	147 lbs.
FARCE	6"	8-1/2"	24"	11-5/8"	5/8"	7"	3/4"	Split 1/16" above & below centerline	179 lbs.
FLAKE	6"	8-3/4"	20"	11-5/8"	5/8"	7"	7/8"	Split 1/16" above & below centerline Male pilot 8" x 1/4"	175 lbs.
FERRY	6"	8-3/4"	24"	11-5/8"	5/8"	7"	7/8"	Split 1/16" above & below centerline	-
FENCE	6-1/4"	8"	22-1/2"	10-5/8"	9/16"	7-1/8"	3/8"	DMI #427713	97 lbs.
FLARE	6-1/2"	8-3/8"	23-1/2"	11"	9/16"	7-3/8"	7/16"	DMI #427745	113 lbs.
FLEET	6-1/2"	8-3/8"	30"	11"	5/8"	7-1/2"	7/16"		141 lbs.
FLUTE	6-5/8"	8-1/2"	15"	13-1/2"	5/8"	7-1/2"	7/16"		100 lbs.
FLOOR	6-5/8"	8-1/2"	24"	11-1/4"	9/16"	7-5/8"	7/16"		133 lbs.
FETCH	6-5/8"	8-5/8"	15"	13-1/2"	5/8"	7-5/8"	1/2"	Male pilot 8-5/8" x 3/8"	104 lbs.
FRANK	6-5/8"	8-5/8"	24"	11-1/4"	9/16"	7-5/8"	3/8"		130 lbs.



SPECIAL HANDLING MAY APPLY



www.repuestoselnavegante.com El Navegante

Electronics

Trolling Motors

Instruments

Electrical

Lighting

Anchor & Dock

Safety

Steering, Controls

Pumps

Fuel System

Seating & Pedestals

Trailer

Tops & Covers

Perform.

Propellers

Engine & Care

Cleaning & Care

Paint & Paint Acc.

Fun & Flotation

Topside Acc.

Cockpit & Deck

Hardware, Fasteners

Camouflage

Misc.

Comm.

Johnson Cutless® Flanged Bearing Specifications Chart (continued)

Call 1-800-347-4464 for Lowest Price

	Code	(A) Shaft or Sleeve Size	(B) Outside Diameter	(C) Length	(D) Flange Diameter	(E) Flange Thickness	(F) Metal ID	(G) Metal Thickness	Special Instructions	Shipping Weight
	FROZE	6-3/4"	8-3/4"	24"	11-1/4"	5/8"	7-7/8"	7/16"	DMI #427749	127 lbs.
	FORCE	6-3/4"	8-3/4"	24"	11-1/4"	9/16"	7-7/8"	7/16"	Split 1/16" above & below centerline	127 lbs.
	FANCY	6-3/4"	8-3/4"	24-1/2"	11-3/8"	9/16"	7-7/8"	7/16"		135 lbs.
	FLANK	6-3/4"	8-7/8"	15"	13-3/4"	5/8"	7-7/8"	1/2"	Split 1/16" above & below centerline Male pilot 9" x 3/8"	—
	FLASH	6-3/4"	8-7/8"	24-1/2"	11-3/8"	9/16"	7-7/8"	1/2"	Split 1/16" above & below centerline	138 lbs.
	FOUND	6-7/8"	8-7/8"	24-1/2"	11-3/8"	9/16"	7-7/8"	1/2"		134 lbs.
	GAVEL	7"	9"	25-1/2"	11-5/8"	9/16"	8-1/8"	7/16"	DMI #427751	140 lbs.
	GLAND	7"	9-1/8"	25-1/2"	11-5/8"	9/16"	8-1/8"	1/2"	DMI #427750	154 lbs.
	GLASS	7-1/4"	9-1/4"	26-1/2"	11-7/8"	9/16"	8-3/8"	7/16"		150 lbs.
	GLORY	7-1/2"	9-5/8"	17-1/2"	14-1/2"	1"	8-3/4"	7/16"		129 lbs.
	GLOBE	7-1/2"	9-5/8"	27-1/2"	12-3/4"	9/16"	8-3/4"	7/16"	DMI #427753	160 lbs.
	GIPSY	7-3/4"	9-7/8"	28-1/2"	12-1/2"	9/16"	8-7/8"	1/2"	DMI #427754	180 lbs.
Electronics	HARDY	8"	10-1/4"	20"	14-7/8"	5/8"	9-1/4"	1/2"	Male pilot 10-3/8" x 3/8"	145 lbs.
Trolling Motors	HEART	8"	10-1/4"	29-1/2"	13-1/4"	5/8"	9-1/2"	1/2"	DMI #427763	166 lbs.
	HEDGE	8"	10-1/2"	29-1/2"	13-1/4"	5/8"	9-1/2"	1/2"	DMI #427787	210 lbs.
Instruments	HITCH	8-1/4"	10-1/2"	30-1/2"	13-1/2"	5/8"	9-1/2"	1/2"		208 lbs.
	HOIST	8-1/2"	10-3/4"	31-1/2"	13-3/4"	5/8"	9-3/4"	1/2"	DMI #427640	215 lbs.
	HOVER	8-3/4"	11"	32-1/2"	14"	5/8"	10"	1/2"	DMI #427838	233 lbs.
Electrical	INFRA	9"	11-1/4"	33-1/2"	14-1/4"	3/4"	10-1/4"	1/2"	DMI #427790	254 lbs.
	IDEAL	9"	11-1/2"	33-3/8"	15"	3/4"	10-1/4"	5/8"	DMI #427789	301 lbs.
Lighting	IDIOT	9"	12"	21-3/8"	17-5/8"	1"	10-1/4"	7/8"	Split 1/8" above & below centerline Male pilot 11-1/2" x 3/8"	287 lbs.
Anchor & Dock	INNER	9-1/8"	11-1/2"	34-1/2"	16-3/8"	5/8"	10-3/8"	9/16"		284 lbs.
	INLET	9-1/4"	11-1/2"	22-1/2"	16"	3/4"	10-1/2"	1/2"	Male pilot 11-1/2" x 3/8"	200 lbs.
Safety	IRISH	9-1/8"	11-1/2"	34-1/2"	14-5/8"	11/16"	10-1/2"	1/2"		260 lbs.
	INSET	9-1/2"	11-3/4"	35-1/2"	14-7/8"	3/4"	10-3/4"	1/2"		274 lbs.
Steering, Controls	INSUL	9-1/2"	11-7/8"	20-3/4"	14-3/4"	1"	10-3/4"	9/16"	Split 1/16" above & below centerline	170 lbs.
	IVORY	9-3/4"	12-1/8"	36-1/2"	15-1/4"	3/4"	11"	9/16"		307 lbs.
Pumps	JEWEL	10"	12-3/8"	37-1/2"	15-1/2"	3/4"	11-1/4"	9/16"		333 lbs.
	JETTY	10-1/4"	12-5/8"	38-1/2"	15-7/8"	3/4"	11-1/2"	9/16"		352 lbs.
Fuel System	JUMBO	10-1/2"	12-7/8"	39-1/2"	16-1/8"	3/4"	11-3/4"	9/16"	DMI #427791	350 lbs.
	JOLLY	10-3/4"	13-1/8"	25"	18-1/4"	3/4"	12"	9/16"	Male pilot 13-1/8" x 3/8"	247 lbs.
	JUDGE	10-3/4"	13-1/8"	40-1/2"	16-3/8"	3/4"	12"	9/16"		368 lbs.
Seating & Pedestals	KETCH	11"	13-1/2"	27-1/2"	18-5/8"	3/4"	12-3/8"	9/16"	Male pilot 13-1/2" x 3/8"	300 lbs.
	KNOCK	11"	13-1/2"	41-1/2"	17-1/4"	3/4"	12-3/8"	9/16"	DMI #427795	420 lbs.
Trailer	KRAFT	11-1/4"	13-3/4"	42-1/2"	17-1/2"	3/4"	12-5/8"	9/16"	DMI #427799	432 lbs.
	KNEEL	11-1/2"	14-1/8"	43-1/2"	17-7/8"	3/4"	12-7/8"	5/8"	DMI #427804	482 lbs.
Tops & Covers	KNIFE	11-1/2"	14-7/8"	50-3/4"	20-1/4"	1-1/4"	12-7/8"	1"		860 lbs.
	KNOTS	11-3/4"	14-3/8"	44-1/2"	18-1/8"	3/4"	13-1/8"	5/8"		502 lbs.
Perform.	LABOR	12"	14-3/4"	45-1/2"	18-1/2"	3/4"	13-1/2"	5/8"	DMI #427809	516 lbs.
	LOGAN	12-1/8"	14-7/8"	46"	18-5/8"	3/4"	13-5/8"	5/8"		—
Propellers	LANCE	12-1/4"	15"	46-1/2"	18-3/4"	3/4"	13-3/4"	5/8"		539 lbs.
	LEASE	12-3/8"	15-1/8"	47"	18-7/8"	3/4"	13-7/8"	5/8"		—
Engine & Care	LAYER	12-1/2"	15-1/4"	47-1/2"	19"	3/4"	14"	5/8"		554 lbs.
	LOGIC	12-5/8"	15-3/8"	48"	19-1/8"	3/4"	14-1/8"	5/8"	DMI #427813	582 lbs.
Cleaning & Care	MILKY	12-3/4"	15-1/2"	48-1/2"	19-1/4"	3/4"	14-1/4"	5/8"		—
	MUSIC	12-7/8"	15-5/8"	49"	19-3/8"	3/4"	14-3/8"	5/8"		—
Paint & Paint Acc.	MINCE	13"	15-7/8"	50"	19-5/8"	7/8"	14-1/2"	11/16"	DMI #427817	674 lbs.
	MITTY	13-1/8"	16"	50-1/2"	19-3/4"	7/8"	14-5/8"	11/16"		710 lbs.
Fun & Flotation	MISTY	13-1/4"	16-1/8"	51"	19-7/8"	7/8"	14-3/4"	11/16"		—
	NIFTY	13-3/8"	16-1/4"	51-1/2"	20"	7/8"	14-7/8"	11/16"		696 lbs.
Topside Acc.	NIECE	13-1/2"	16-3/8"	52"	20-1/8"	7/8"	15"	11/16"		697 lbs.
	NOVEL	13-5/8"	16-1/2"	52-1/2"	20-1/4"	7/8"	15-1/8"	11/16"		—
Cockpit & Deck	ORTHA	13-3/4"	16-5/8"	53"	20-3/8"	7/8"	15-1/4"	11/16"		—
	OGGLE	13-7/8"	16-3/4"	53-1/2"	20-1/2"	7/8"	15-3/8"	11/16"		—
Hardware, Fasteners	OPERA	14"	16-7/8"	54"	20-5/8"	7/8"	15-1/2"	11/16"		735 lbs.
	PURSE	14-1/8"	17"	54-1/2"	20-3/4"	7/8"	15-5/8"	11/16"		—
	POLAR	14-1/4"	17-1/8"	55"	20-7/8"	7/8"	15-3/4"	11/16"		—
Camouflage	POINT	14-3/8"	17-1/4"	55-1/2"	21"	7/8"	15-7/8"	11/16"		842 lbs.
	PRUNE	14-1/2"	17-1/2"	56"	21-1/4"	7/8"	16"	3/4"		852 lbs.
Misc.	PRICE	14-5/8"	17-5/8"	56-1/2"	21-3/8"	7/8"	16-1/8"	3/4"		—
	PUNCH	14-3/4"	17-3/4"	57"	21-1/2"	7/8"	16-1/4"	3/4"		—
Comm.	QUAKE	14-7/8"	17-7/8"	57-1/2"	21-5/8"	7/8"	16-3/8"	3/4"		—
	QUIET	15"	18"	58"	21-3/4"	7/8"	16-1/2"	3/4"	DMI #427821	905 lbs.



Buck-Algonquin Transmission Couplers



Split Coupling



Taper Coupling

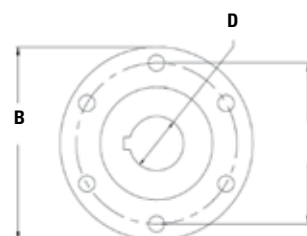

Solid Coupling

A - Overall Length
B - Flange DiameterC - Bolt Circle
D - Shaft Diameter

- Buck Algonquin manufactures a full line of transmission couplers for most marine transmissions.
- Our couplers are cast from ductile iron and machined to SAE J755 specifications. Most of our couplers are machined with our universal bolt hole pattern. As well, all of our couplers are supplied with mounting hardware.

SPLIT COUPLERS

Flange Diameter 4" - B Series Fits: BorgWarner #1017-71C
Flange Diameter 5" - A and C Series Fits: BorgWarner #1018-72C

Flange Diameter 5-3/4" - A and B Series Fits: BorgWarner #1018-73C
Flange Diameter 5-3/4" - A and B Series Fits: Twin Disc, Capitol and Allison

Order No.	Mfg. No.	Transmission	Flange Dia.	Overall Length	Shaft Dia.	# of Bolts	Bolt Size	Bolt Circle	Pilot	List Price
257750	(50400B1000)	BorgWarner, Hurth	4"	3-7/16"	1"	4	3/8"	3-1/4"	M	\$135.49 HO-9218000
257774	(50400B1250)	BorgWarner, Hurth	4"	3-7/16"	1-1/4"	4	3/8"	3-1/4"	M	\$139.69 HO-1838000
257798	(50400B1500)	BorgWarner, Hurth	4"	3-7/16"	1-1/2"	4	3/8"	3-1/4"	M	\$139.69 HO-1838000
257811	(50401S1125)	BorgWarner, Hurth	4"	2"	1-1/8"	4	3/8"	3-1/4"	M	\$124.89 HO-3947000
257863	(50475A1500)	Capitol, Twin Disc	4-3/4"	3-1/2"	1-1/2"	6	7/16"	3-7/8"	F	\$162.19 HO-1379000
257899	(50475B1750U)	Capitol, Twin Disc	4-3/4"	4"	1-3/4"	6	7/16"	3-7/8"	F	\$190.69 HO-1441100
257904	(50476A1375)	ZF	4-3/4"	3-1/2"	1-3/8"	6	12mm	3-7/8"	F	\$154.49 HO-9629000
257926	(50500A1250)	BorgWarner, Hurth, Newage	5"	3-7/16"	1-1/4"	4	7/16"	4-1/4"	M	\$154.99 HO-9929000
257938	(50500A1375)	BorgWarner, Hurth, Newage	5"	3-7/16"	1-3/8"	4	7/16"	4-1/4"	M	\$159.79 HO-7859000
257940	(50500A1500)	BorgWarner, Hurth, Newage	5"	3-7/16"	1-1/2"	4	7/16"	4-1/4"	M	\$159.79 HO-7859000
257990	(50500C1750)	BorgWarner, Hurth, Newage	5"	4"	1-3/4"	4	7/16"	4-1/4"	M	\$179.79 HO-7870100
258005	(50500C2000)	BorgWarner, Hurth, Newage	5"	4"	2"	4	7/16"	4-1/4"	M	\$179.79 HO-7870100
258007	(50500YS125)	Yanmar	4-3/4"		1-1/4"	4	10mm	3-15/16"	M	\$156.39 HO-3839000
258010	(50500YS137)	Yanmar	4-3/4"		1-3/8"	4	10mm	3-15/16"	M	\$156.39 HO-3839000
258043	(5057511500)	Allison, BorgWarner, Capitol, Newage	5-3/4"	4-3/16"	1-1/2"	6	1/2"	4-3/4"	F	\$359.69 HO-1851200
258055	(5057511750)	Allison, BorgWarner, Capitol, Newage	5-3/4"	4-3/16"	1-3/4"	6	1/2"	4-3/4"	F	\$359.69 HO-1851200
258067	(5057512000)	Allison, BorgWarner, Capitol, Newage	5-3/4"	4-3/16"	2"	6	1/2"	4-3/4"	F	\$359.69 HO-1851200
258080	(5057521500)	Twin Disc, ZF	5-3/4"	4-3/16"	1-1/2"	6	5/8"	4-3/4"	F	\$359.69 HO-1851200
258092	(50575175U)	Twin Disc, ZF	5-3/4"		1-3/4"	6	5/8"	4-3/4"	F	\$359.69 HO-1851200
258095	(50575200U)	Twin Disc, ZF	5-3/4"	4-3/16"	2"	6	5/8"	4-3/4"	F	\$348.99 HO-9390200

SOLID COUPLERS

Order No.	Mfg. No.	Transmission	Flange Dia.	Overall Length	Shaft Dia.	# of Bolts	Bolt Size	Bolt Circle	Pilot	List Price
258219	(50MC004100)	BorgWarner, Hurth	4"	2-1/4"	1"	4	3/8"	3-1/4"	M	\$98.99 HO-9395000
258233	(50MC004125)	BorgWarner, Hurth	4"	2-1/4"	1-1/4"	4	3/8"	3-1/4"	M	\$98.99 HO-9395000
258269	(50MC005125)	BorgWarner, Hurth, Newage	5"	2-5/8"	1-1/4"	4	7/16"	4-1/4"	M	\$151.09 HO-5609000
258283	(50MC005150)	Borg Warner, Hurth, Newage	5"	2-5/8"	1-1/2"	4	7/16"	4-1/4"	M	\$151.09 HO-5609000

TAPER COUPLERS

Order No.	Mfg. No.	Transmission	Flange Dia.	Overall Length	Shaft Dia.	# of Bolts	Bolt Size	Bolt Circle	Pilot	List Price
258315	(50TC669225)	ZF	6.69"	7-1/2"	2-1/4"	12	16mm	5.512"	F	\$749.09 HO-5494400
258325	(50TC807300)	ZF	8.07"	5-1/2"	3"	10	18mm	6.693"	F	\$1,039.59 HO-5732600

DURAMAX

DryMax™ Stern Tube Seal System

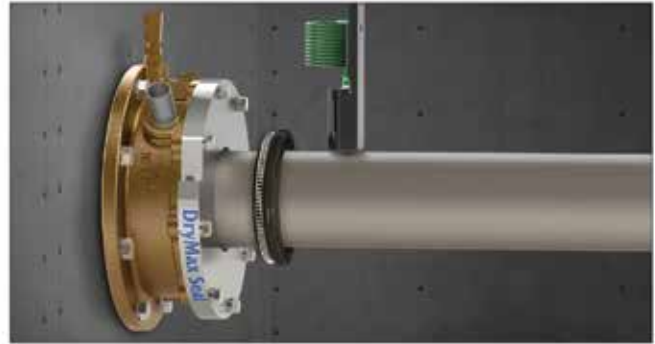
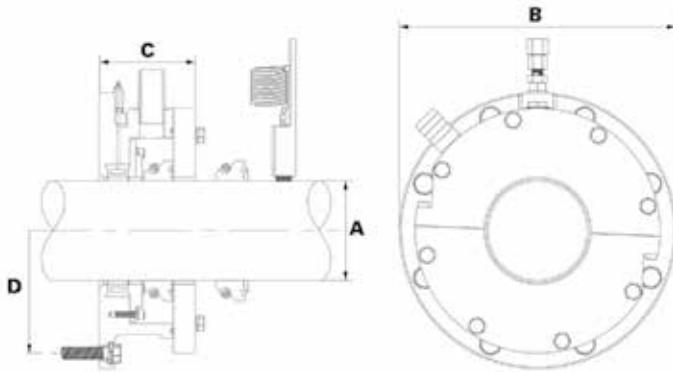

SEAL SPACE REQUIREMENTS

Model	A Shaft Size (in)	A Shaft Size (mm)	B Flange OD (in)	B Flange OD (mm)	C Length (in)	C Length (mm)	D BCD (in)	D BCD (mm)	Bolt (in)
300	2.5 - 3.49	64 - 88	10 1/8	258	4 1/2	115	8 7/8	225.4	1/2
400	3.5 - 4.49	89 - 114	11 1/8	283	4 1/2	115	9 7/8	250.8	1/2
500	4.5 - 5.49	115 - 139	12 1/8	308	4 1/2	115	10 7/8	276.2	1/2
600	5.5 - 6.49	140 - 165	13 1/8	334	4 1/2	115	11 7/8	301.6	1/2
700	6.5 - 7.49	166 - 190	14 1/8	359	4 1/2	115	12 7/8	327.0	1/2
800	7.5 - 8.49	191 - 215	15 1/8	385	4 1/2	115	13 7/8	352.4	1/2
900	8.5 - 9.49	216 - 241	16 3/8	416	5	127	15	381.0	5/8
1000	9.5 - 10.49	242 - 266	17 3/8	442	5	127	16	406.4	5/8
1100	10.5 - 11.49	267 - 292	18 3/8	467	5	127	17	431.8	5/8
1200	11.5 - 12.49	293 - 317	19 3/8	493	5	127	18	457.2	5/8
1300	12.5 - 13.49	318 - 342	20 3/8	518	5	127	19	482.6	5/8
1400	13.5 - 14.49	343 - 368	21 3/8	543	5	127	20	508.0	5/8
1500	14.5 - 15.49	369 - 393	22 5/8	575	5 1/8	131	21 1/8	536.6	3/4
1600	15.5 - 16.49	394 - 419	23 5/8	601	5 1/8	131	22 1/8	562.0	3/4
1700	16.5 - 17.49	420 - 444	24 5/8	626	5 1/8	131	23 1/8	587.4	3/4
1800	17.5 - 18.49	445 - 469	25 5/8	651	5 1/8	131	24 1/8	612.8	3/4
1900	18.5 - 19.49	470 - 495	26 5/8	677	5 1/8	131	25 1/8	638.2	3/4
2000	19.5 - 20.49	496 - 520	27 5/8	702	5 1/8	131	26 1/8	663.6	3/4
2100	20.5 - 21.49	521 - 546	28 7/8	734	5 1/8	131	27 1/4	692.2	7/8
2200	21.5 - 22.49	547 - 571	29 7/8	759	5 1/8	131	28 1/4	717.6	7/8
2300	22.5 - 23.49	572 - 596	30 7/8	785	5 1/8	131	29 1/4	743.0	7/8
2400	23.5 - 24.49	597 - 622	31 7/8	810	5 1/8	131	30 1/4	768.4	7/8
2500	24.5 - 25.49	623 - 647	32 7/8	836	5 1/8	131	31 1/4	793.8	7/8
2600	25.5 - 26.49	648 - 673	33 7/8	861	5 1/8	131	32 1/4	819.2	7/8
2700	26.5 - 27.49	674 - 698	35 1/8	893	5 1/8	131	33 3/8	847.7	1
2800	27.5 - 28.49	699 - 723	36 1/8	918	5 1/8	131	34 3/8	873.1	1
2900	28.5 - 29.49	724 - 749	37 1/8	943	5 1/8	131	35 3/8	898.5	1
3000	29.5 - 30.49	750 - 774	38 1/8	969	5 1/8	131	36 3/8	923.9	1
3100	30.5 - 31.49	775 - 800	39 1/8	994	5 1/8	131	37 3/8	949.3	1
3200	31.5 - 32.49	801 - 825	40 1/8	1020	5 1/8	131	38 3/8	974.7	1
3300	32.5 - 33.49	826 - 850	41 5/8	1058	5 1/8	131	39 5/8	1006.5	1 1/4
3400	33.5 - 34.49	851 - 876	42 5/8	1083	5 1/8	131	40 5/8	1031.9	1 1/4
3500	34.5 - 35.49	877 - 901	43 5/8	1109	5 1/8	131	41 5/8	1057.3	1 1/4
3600	35.5 - 36.49	902 - 927	44 5/8	1134	5 1/8	131	42 5/8	1082.7	1 1/4

- Electronics
- Trolling Motors
- Instruments
- Electrical
- Lighting
- Anchor & Dock
- Safety
- Steering, Controls
- Pumps
- Fuel System
- Seating & Pedestals
- Trailering
- Tops & Covers
- Perform.
- Propellers
- Engine & Care
- Cleaning & Care**
- Paint & Paint Acc.
- Fun & Flotation
- Topside Acc.
- Cockpit & Deck
- Hardware, Fasteners
- Camouflage
- Misc.
- Comm.

Zinc anodes should be use for saltwater applications.
Aluminum anodes should be used for saltwater or brackish water applications.
Magnesium anodes should be used for freshwater applications.

Zinc Tear Drop Anode



- Zinc Tear Drop.
- (1) Cast-in Galvanized Steel Strap, Weld on.
- 5 lbs.
- Dimensions: 3" W x 9" L x 1-1/4" T.

Order No.	Mfg. No. / Description	List Price	
323600	(GATD6/ZTS6)	\$16.79	CO-7241000

Zinc Plate Hull Anode



- Zinc Plate.
- (2) Cast-in Cored Holes on 6" centers.
- 22 lbs.
- Dimensions: 6" W x 12" L x 1-1/4" T.

Order No.	Mfg. No. / Description	List Price	
323843	(GA23C)	\$69.59	CO-5195000

Magnesium Launch Anode with Plasticol Coating



- 1 Cast-in Galvanized Steel Strap, Weld on with 5/8" holes for mounting.
- 5 lbs.
- Dimensions: 5" W x 10" L x 2-1/2" T.

Order No.	Mfg. No. / Description	List Price	
323864	(GAMG5LAUNCH)	\$48.99	CO-4614000

R.E. Thomas Anodes



Order No.	Mfg. No. / Description	List Price	
040129	(8X-SL) Anode 1-3/4"	\$21.98	B0-8791000
040131	(9X-SL) Anode 2"	\$19.98	B0-8971000
040143	(11X-SL) Anode 2-1/2"	\$37.98	B0-8143000
040167	(5HC) Anode 5"	\$35.98	B0-8323000
040155	(2R) Bi-Direct Anode 2"	\$8.98	B0-8080000

Zinc Plate Hull Anodes



- Zinc Plate.
- (1) Cast-in Galvanized Steel Strap, Weld on.
- 11-1/2 lbs.
- Dimensions: 3" W x 12" L x 1-1/4" T.

Order No.	Mfg. No. / Description	List Price	
323834	(ZSS-12)	\$58.98	CO-3105000
323838	(GA12/ZSS12)	\$36.79	CO-7213000

Zinc Plate Hull Anodes

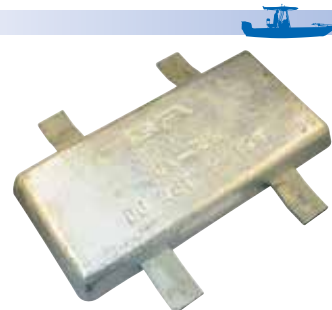

- Zinc Plate.
- (2) Cast-in Galvanized Steel Straps, Weld on.
- 22 lbs.
- Dimensions: 6" W x 12" L x 1-1/4" T.

Order No.	Mfg. No. / Description	List Price	
323840	(GA-23/ZHS-23)	\$68.49	CO-2285000
323841	(ZHS-23)	\$107.98	CO-8719000

Magnesium Hull Anode with Plasticol Coating

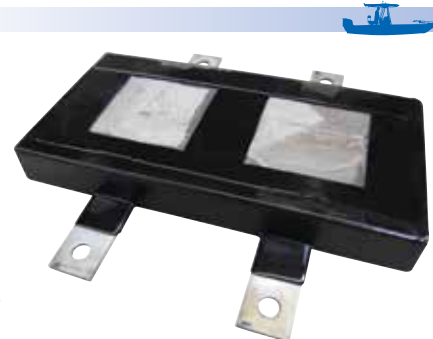

- (2) Cast-in 1/4" x 2" Galvanized Steel Straps, Weld on.
- 24 lbs.
- Dimensions: 9" W x 18" L x 2" T.

Order No.	Mfg. No. / Description	List Price	
323903	(GAMGH24W)	\$159.19	CO-1353100

Magnesium Tear Drop Anode with Plasticol Coating



- (1) Cast-in Galvanized Steel Strap, Weld on.
- 2.5 lbs.
- Dimensions: 3" W x 9" L x 1-3/8" T.

Order No.	Mfg. No. / Description	List Price	
323852	(GAMGJR)	\$28.19	CO-6932000

- Electronics
- Trolling Motors
- Instruments
- Electrical
- Lighting
- Anchor & Dock
- Safety
- Steering, Controls
- Pumps
- Fuel System
- Seating & Pedestals
- Trailer
- Tops & Covers
- Perform.
- Propellers
- Engine & Care
- Cleaning & Care
- Paint & Paint Acc.
- Fun & Flotation
- Topside Acc.
- Cockpit & Deck
- Hardware, Fasteners
- Camouflage
- Misc.
- Comm.

Zinc anodes should be use for saltwater applications.
Aluminum anodes should be used for saltwater or brackish water applications.
Magnesium anodes should be used for freshwater applications.

Sierra Anodes for Generators



FITS: 4-7.3 Kw. 4EF, 5E, 6EF AND 7.3E

Order No.	Mfg. No. / Description	List Price
23-6400	(23-6400) Replaces: Westerbeke 11885, Kohler 260085	\$7.49 Z0-6340000

FITS: VARIOUS 9-32 Kw. MDK SERIES

Order No.	Mfg. No. / Description	List Price
23-6401	(23-6401) Replaces: Onan 130-4434	\$19.14 Z0-4421000

Sierra Complete Engine Anodes with Brass Plug



Order No.	Mfg. No. / Description	List Price
186059	(18-6059) Length 1-3/4" Dia. 3/8" Plug 1/4"	\$5.49 Z0-7130000
186060	(18-6060) Length 2" Dia. 1/2" Plug 3/8"	\$7.49 Z0-7340000
186062	(18-6062) Length 2" Dia. 5/8" Plug 1/2"	\$5.79 Z0-7730000

Martyr Zinc Shaft Anodes



- Designed to install over the propeller shaft and provide maximum corrosion protection.
- Comes with stainless steel hardware: Screw (either Allen head or slotted head), lock washer and bolt retaining washer.

Order No.	Mfg. No.	Height	Shaft Size	OD	List Price
620149	(CMX05)	2.35"	1.25"	2.42"	\$9.69 G0-9460000
620150	(CMX07)	2.5"	1.5"	2.78"	\$14.29 G0-7590000
620152	(CMX08)	2.75"	1.75"	3.25"	\$19.49 G0-6031000
620153	(CMX09)	2.9"	2"	3.6"	\$23.39 G0-7651000

Sierra Zinc Shaft Anodes

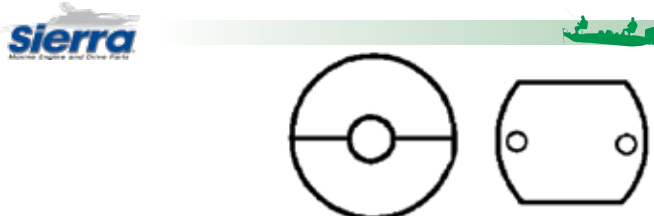

Order No.	Mfg. No. / Description	List Price
1860411	(18-6041-1) ID 1-1/4" OD 2-5/8" Height 2-1/2"	\$13.69 Z0-9590000
1860431	(18-6043-1) ID 1-1/2" OD 2-1/2" Height 2-1/2"	\$15.75 Z0-1011000

Zinc Engine Anodes with Brass Plugs

- Additional sizes available via special orders. Contact your Donovan sales rep. for details.



Order No.	Mfg. No. / Description	List Price
269831	(E-00) 1/8" Plug (NPT) Dia. 1/4" 2" L	\$2.49 G0-7610000
269832	(E-0) 1/4" Plug (NPT) Dia. 3/8" 1-3/4" L	\$3.69 G0-7420000
269844	(E-1) 3/8" Plug (NPT) Dia. 1/2" 2" L	\$5.49 G0-8630000
269959	(E-1D) 3/8" Plug (NPT) Dia. 1/2" 1-3/4" L	\$5.19 G0-8430000
269960	(E-1E) 3/8" Plug (NPT) Dia. 1/2" 1-1/2" L	\$5.19 G0-8430000
269961	(E-1F) 3/8" Plug (NPT) Dia. 1/2" 1-1/4" L	\$5.19 G0-8430000
269856	(E-2) 1/2" Plug (NPT) Dia. 5/8" 2" L	\$7.79 G0-2250000
269868	(E-3) 3/4" Plug (NPT) Dia. 3/4" 2" L	\$11.19 G0-0570000
269882	(E-4) 3/4" Plug (NPT) Dia. 3/4" 3-3/8" L	\$11.69 G0-3870000
269907	(E-7) 1" Plug (NPT) Dia. 1-1/16" 5" L	\$31.89 H0-3191000

ZINC ONLY

Order No.	Mfg. No. / Description	List Price
269956	(E-00Z) For MDE-00 Diameter 1/4" 2" L	\$0.79 G0-3500000
269957	(E-0Z) For MDE-0 Diameter 3/8" 1-3/4" L	\$0.99 G0-6600000
269969	(E-1Z) For MDE-1 Diameter 1/2" 2" L	\$1.49 G0-0010000
269971	(E-2Z) For MDE-2 Diameter 5/8" 2" L	\$1.89 G0-7210000
269983	(E-3Z) For MDE-3 Diameter 3/4" 2" L	\$2.09 G0-0410000
270001	(E-4Z) For MDE-4 Diameter 3/4" 3-3/8" L	\$3.29 G0-0220000

FOR DETROIT DIESEL, DIAMETER 3/4", LENGTH 3-3/8"

Order No.	Mfg. No. / Description	List Price
270018	(8515850) Zinc Only	\$2.89 G0-4910000
270019	(8515850C) Zinc Complete	\$14.99 G0-4001000

Camp Zinc Shaft Anodes



- Meets all MIL-A-18001 specifications.
- Used as sacrificial anodes to protect propellers, struts, bearings, etc. from underwater electrolysis.
- Allen screw held in by washer.
- Copper contact for permanent ground.
- Stainless nut cast in.

Order No.	Mfg. No. / Description	List Price
338548	(X-0) Shaft Size 1/2"	\$8.19 G0-9450000
338550	(X-01) Shaft Size 3/4"	\$6.19 G0-5140000
338562	(X-02) Shaft Size 7/8"	\$5.99 G0-1040000
338574	(X-03) Shaft Size 1"	\$6.79 G0-5540000
338586	(X-04) Shaft Size 1-1/8"	\$7.79 G0-2250000
338598	(X-05) Shaft Size 1-1/4"	\$8.09 G0-2450000
338613	(X-06) Shaft Size 1-3/8"	\$10.39 G0-6960000
338625	(X-07) Shaft Size 1-1/2"	\$10.39 G0-6960000
338637	(X-08) Shaft Size 1-3/4"	\$16.39 G0-8901000
338649	(X-09) Shaft Size 2"	\$16.99 G0-8311000
338651	(X-10) Shaft Size 2-1/4"	\$36.09 G0-8142000
338663	(X-11) Shaft Size 2-1/2"	\$34.99 G0-4432000
338675	(X-12) Shaft Size 2-3/4"	\$48.99 G0-2823000
338687	(X-13) Shaft Size 3"	\$41.99 G0-3182000
338699	(X-15) Shaft Size 3-1/2"	\$54.69 G0-4663000
338702	(X-17) Shaft Size 4"	\$66.09 G0-8244000
338714	(X-18) Shaft Size 4-1/2"	\$71.49 G0-0974000

HEAVY DUTY ZINC SHAFT ANODES

Order No.	Mfg. No. / Description	List Price
338575	(X-03A) 1"	\$8.29 G0-5550000
338599	(X-05A) 1-1/4"	\$13.09 G0-7780000



Zinc anodes should be use for saltwater applications.
Aluminum anodes should be used for saltwater or brackish water applications.
Magnesium anodes should be used for freshwater applications.

Martyr Aluminum Shaft Anodes

Martyr



- Designed to install over the propeller shaft and provide maximum corrosion protection.
- For use in salt and brackish waters.
- Comes with stainless steel hardware: Screw (either Allen head or slotted head), lock washer and bolt retaining washer.

Order No.	Mfg. No.	Height	Shaft Size	OD	List Price	
620137	(CMX05AL)	2.35"	1-1/4"	2.42"	\$8.69	GO-2850000
620138	(CMX06AL)	2.35"	1-3/8"	2.66"	\$10.99	GO-6370000
620139	(CMX07AL)	2.5"	1-1/2"	2.78"	\$11.19	GO-0570000

Camp Zinc Rudder Anodes



- Meets all MIL-A-18001 specifications.
- Used as sacrificial anodes to protect propellers, struts, bearings, etc. from underwater electrolysis.
- Brass bushing for permanent ground.
- Supplied with stainless steel screws and lock washers.

Order No.	Mfg. No. / Description	List Price	
269135	(R-01) 1-7/8"	\$2.59	GO-4710000
338461	(R-02) 2-13/16"	\$7.19	GO-2840000
338473	(R-03) 3-3/4"	\$10.19	GO-3860000
338485	(R-04) 5"	\$18.59	GO-6421000
338497	(R-05) 5-1/8"	\$27.29	GO-8281000
338500	(R-07) 6-1/2"	\$41.49	GO-0872000

Sierra Zinc Rudder Anodes

Sierra

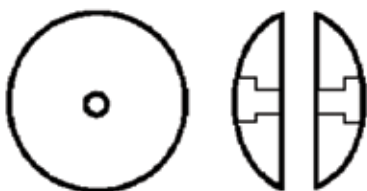

Order No.	Mfg. No. / Description	List Price	
186045	(18-6045) Diameter 1-7/8" Weight .20 lbs.	\$5.69	ZO-1430000
186046	(18-6046) Diameter 2-13/16" Weight .90 lbs.	\$16.99	ZO-1001000
186047	(18-6047) Diameter 3-3/4" Weight 1.40 lbs.	\$23.99	ZO-9341000
186107	(18-6107) Diameter 5"	\$25.49	ZO-7871000

Martyr Aluminum Rudder Anodes

Martyr

- Disc shaped plates of aluminum designed to minimize corrosion around your boat's metal rudders.
- For use in salt and brackish waters.
- Includes stainless steel bolt and nut.
- Bolt retaining washers prevent the anode from falling off - easy installation underwater.

Order No.	Mfg. No. / Description	List Price	
620141	(CMR02AL) Diameter 2.81" Thickness 0.5"	\$7.29	GO-8840000
620142	(CMR03AL) Diameter 3.75" Thickness 0.5"	\$9.99	GO-9660000
620143	(CMR04AL) Diameter 5" Thickness 0.65"	\$20.29	GO-9531000

Camp Zinc Donut Shaft Anodes



- Meets all MIL-A-18001 specifications.
- Used as sacrificial anodes to protect propellers, struts, bearings, etc. from underwater electrolysis.
- Supplied with stainless steel screws and lock washers.
- Sizes up to 6-1/2" are available.

Order No.	Mfg. No.	Shaft Size	OD	List Price	
338308	(C-01)	3/4"	2-1/8"	\$7.19	GO-2840000
338310	(C-02)	7/8"	2-1/8"	\$7.19	GO-2840000
338322	(C-03)	1"	2-1/2"	\$9.79	GO-6560000
368334	(C-04)	1-1/8"	2-1/2"	\$9.79	GO-6560000
338346	(C-05)	1-1/4"	2-1/2"	\$9.79	GO-6560000
338358	(C-06)	1-3/8"	3"	\$11.79	GO-0970000
338360	(C-07)	1-1/2"	3"	\$11.79	GO-0970000
338363	(C-08)	1-3/4"	3-1/2"	\$16.29	GO-1901000
269351	(C-09)	2"	3-1/2"	\$16.29	GO-1901000
338672	(C-10)	2"	4"	\$19.39	GO-9921000
269363	(C-11)	2-1/4"	4"	\$20.69	GO-6831000
269375	(C-12)	2-1/2"	5"	\$28.29	GO-5981000
269387	(C-12A)	2-3/4"	5"	\$28.29	GO-5981000
269399	(C-13)	3"	5"	\$28.29	GO-5981000
269426	(C-14)	3-1/2"	6-1/2"	\$34.99	GO-4432000
269438	(C-15)	4"	6-1/2"	\$34.89	GO-8332000

Martyr Zinc Rudder Anodes

Martyr

- Disc shaped plates of aluminum designed to minimize corrosion around your boat's metal rudders.
- Includes stainless steel bolt and nut.
- Bolt retaining washers prevent the anode from falling off - easy installation underwater.



Order No.	Mfg. No. / Description	List Price	
620144	(CMR02) Diameter 2.81" Thickness 0.5"	\$8.79	GO-9850000
620145	(CMR03) Diameter 3.75" Thickness 0.5"	\$12.19	GO-7180000
620146	(CMR04) Diameter 5" Thickness 0.65"	\$22.29	GO-3941000
620147	(CMR05) Diameter 5.12" Thickness 0.87"	\$32.89	GO-4022000

Zinc anodes should be use for saltwater applications.
 Aluminum anodes should be used for saltwater or brackish water applications.
 Magnesium anodes should be used for freshwater applications.

- Electronics
- Trolling Motors
- Instruments
- Electrical
- Lighting
- Anchor & Dock
- Safety
- Steering, Controls
- Pumps
- Fuel System
- Seating & Pedestals
- Trailer
- Tops & Covers
- Perform.
- Propellers
- Engine & Care
- Paint & Paint Acc.
- Fun & Flotation
- Topside Acc.
- Cockpit & Deck
- Hardware, Fasteners
- Camouflage
- Misc.
- Comm.

Camp Zinc Plates for Hull - Bolt-On



- Meets all MIL-A-18001 specifications.
- Used as sacrificial anodes to protect propellers, struts, bearings, etc. from underwater electrolysis.

Order No.	Mfg. No.	Dimensions	List Price	
338271	(A-24)	4-3/4" L x 2" W x 3/4" T	\$5.29	GO-4530000
338283	(A-25)	9-1/4" L x 3-3/8" W x 3/4" T	\$25.09	GO-1861000
269046	(A-30)	6-1/4" L x 2-3/4" W x 5/8" T	\$10.79	GO-3270000
269047	(A-40)	7-1/2" L x 2-3/4" W x 1/2" T	\$10.89	GO-0370000

Camp Zinc Plates for Hull - Bolt-On



- Meets all MIL-A-18001 specifications.
- Used as sacrificial anodes to protect propellers, struts, bearings, etc. from underwater electrolysis.

Order No.	Mfg. No.	Dimensions	List Price	
338245	(ZHC-03)	6-1/4" L x 2-3/4" W x 3/4" T	\$21.89	GO-7641000
338247	(ZHC-05)	8" L x 4" W x 3/4" T	\$35.69	GO-1932000
338249	(ZHC-11)	12" L x 3" W x 1-1/2" T	\$65.09	GO-1634000
338251	(ZHC-15)	15" L x 3" W x 1-1/2" T	\$96.89	GO-2946000
338254	(ZHC-17)	12" L x 6" W x 1" T	\$159.89	GO-3170100

Camp Zinc Plate for Hull - Bolt-On



- Meets all MIL-A-18001 specifications.
- Used as sacrificial anodes to protect propellers, struts, bearings, etc. from underwater electrolysis.
- Dimensions: 8-5/8" L x 3-3/16" W x 1/2" T.
- One hole - diameter 3/8".

Order No.	Mfg. No. / Description	List Price	
338270	(N-1)	\$23.29	GO-0651000

Camp Zinc Plate for Hull - Bolt-On (Pacemaker Style 1)



- Meets all MIL-A-18001 specifications.
- Used as sacrificial anodes to protect propellers, struts, bearings, etc. from underwater electrolysis.
- Dimensions: 9-1/4" L x 3-3/8" W x 53/64" T.
- One hole.

Order No.	Mfg. No. / Description	List Price	
338295	(A-90)	\$25.09	GO-1861000

Camp Tapered Zinc Plate Anodes for Hull - Bolt-On



- Meets all MIL-A-18001 specifications.
- Used as sacrificial anodes to protect propellers, struts, bearings, etc. from underwater electrolysis.
- With two cast-in 7/16" ID bronze bushings.

Order No.	Mfg. No.	Dimensions	List Price	
338269	(B-12)	9" L x 4-1/2" W x 1-1/8" T	\$76.19	GO-5015000
338268	(B-24)	14" L x 6-1/4" W x 1-1/4" T	\$169.29	GO-2431100

Camp Plain Zinc Plate Anode



- Meets all MIL-A-18001 specifications.
- Used as sacrificial anodes to protect propellers, struts, bearings, etc. from underwater electrolysis.
- Dimensions: 12" L x 6" W x 1/2" T.

Order No.	Mfg. No. / Description	List Price	
338233	(ZP-2)	\$67.79	GO-2454000



Zinc anodes should be use for saltwater applications.
Aluminum anodes should be used for saltwater or brackish water applications.
Magnesium anodes should be used for freshwater applications.

Martyr Mini Divers Dream Aluminum Anode

Martyr



- Dimensions: 5.9" L x 3.9" W x 0.5" H.

Order No. Mfg. No. / Description
620151 (CMDIVERMINIA) Aluminum

List Price
\$16.29 GO-1901000

Martyr Diver's Dream Aluminum Anode

Martyr



- Bolts on to hulls to minimize the corrosive effects of metals in the water.
- Dimensions: 12" L x 6" W x 1/2" T.
- Uses 1/2" studs.

Order No. Mfg. No. / Description
620155 (CMDIVERA)

List Price
\$30.09 GO-6102000

Martyr Sea Strainer Aluminum Anode (Doka)



- Dimensions: 3.25" L x 1.20" W x .45" T.

Order No. Mfg. No. / Description
620157 (CM656934A)

List Price
\$2.79 GO-7810000

Tear Drop Zinc Anodes



Order No. Mfg. No. / Description
269755 (T-20) Dimensions: 3-1/2" L x 1-3/4" W
269779 (T-21) Dimensions: 5-1/4" L x 2" W

List Price
\$3.49 GO-4320000
\$8.09 GO-2450000

Martyr Bennett Trim Tab Anode Kit

Martyr



- Zinc anodes for salt water.
- Fits Bennett Trim Tabs.
- Kit includes: (2) Anodes and stainless steel mounting hardware.

Order No. Mfg. No. / Description List Price
620159 (CMBNT1AKITZ) **\$16.59** GO-2111000

Camp Bennett Trim Tab Kit



- Dimensions: 3-13/16" L x 1-1/8" W.
- Distance between holes: 1-1/2".
- Kit includes: (2) anodes and (4) 1/4"-20 x 1-1/4" long stainless screws.
- Uses existing holes on most popular trim tabs.

Order No. Mfg. No. / Description List Price
338207 (BNT-1) **\$13.29** GO-0980000

Camp Bolt-On Small Divers Zinc Plate for Hull



- Zinc plated steel plate (plate recessed).
- Dimensions: 5-3/4" L x 3-3/4" W x 1/2" T.
- Distance between holes: 7/8".

Order No. Mfg. No. / Description
338221 (DP-2)

List Price
\$20.29 GO-9531000

Camp Bolt-On Divers Zinc Plate for Hull



- Zinc plate cast-in.
- Dimensions: 11-1/2" L x 5-1/2" W x 5/8" T.
- Distance between holes: 2-1/2".

Order No. Mfg. No. / Description
338257 (DP-1)

List Price
\$78.29 GO-5425000

Camp Sea Strainer Zinc Anode



- Dimensions: 3-7/8" L x 1-1/2" W.
- Distance between holes: 1-1/2".

Order No. Mfg. No. / Description
338510 (SZ-01)

List Price
\$4.49 GO-1030000

Camp Maxi-Prop Propeller Zinc Anode

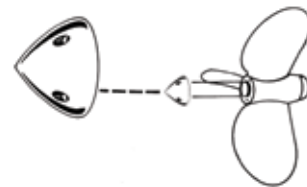

- Shaft sizes: 3/4", 7/8", 1", 1-1/8".

Order No. Mfg. No. / Description
338079 (63M-3) For 2003 Propellers & Newer
338097 (63M) For 2001 & Older Propellers

List Price
\$5.29 GO-4530000
\$5.69 GO-1830000

Camp Grouper Zinc Anode



- Comes with 20 ft. of galvanized wire rope and an electrical connector with instruction sheet enclosed.
- 6 lbs.

Order No. Mfg. No. / Description List Price
269330 (GP-1) **\$51.69** GO-3643000

Electronics

Trolling Motors

Instruments

Electrical

Lighting

Anchor & Dock

Safety

Steering, Controls

Pumps

Fuel System

Seating & Pedestals

Trailer

Tops & Covers

Perform.

Propellers

Engine & Care

Cleaning & Care

Paint & Paint Acc.

Fun & Flotation

Topside Acc.

Cockpit & Deck

Hardware, Fasteners

Camouflage

Misc.

Comm.

Zinc anodes should be use for saltwater applications.
 Aluminum anodes should be used for saltwater or brackish water applications.
 Magnesium anodes should be used for freshwater applications.

Honda Anodos

Sierra Zinc Anode

- Zinc.
- BF75-BF90 HP, 1997-98.
- Replaces: 41109-ZW1-003.

Order No.	Mfg. No. / Description	List Price
186068	(18-6068)	\$10.99 Z0-4460000



EMP Zinc Anode



- Zinc.
- BF75-BF90 HP, 1997-98.
- Replaces: 41107-ZW1-003ZA.

Order No.	Mfg. No. / Description	List Price
4-6011	(93-04000)	\$12.69 G0-0580000

Sierra Anodes



- BF75-BF90 HP, 1997-98.
- Replaces: 41107-ZW1-003ZA.

Order No.	Mfg. No. / Description	List Price
186011	(18-6011) Zinc	\$15.49 Z0-2090000
186011A	(18-6011A) Aluminum	\$13.99 Z0-7280000
186241	(18-6241) Magnesium	\$19.49 Z0-6611000

Johnson/Evinrude/OMC Anodos

Zinc Anode



Order No.	Mfg. No. / Description	List Price
338144	(398331)	\$10.09 G0-6760000

Zinc Anode



- Zinc.
- 90-225 HP, 1991 to present.
- Dimensions: 1" x 1-3/8".

Order No.	Mfg. No. / Description	List Price
269043	(393023)	\$9.09 G0-9060000

Sierra Zinc Anode



- Zinc.
- 60-300 HP 1982-87.
- For use on gearcases.
- Replaces: 393023, 436745.

Order No.	Mfg. No. / Description	List Price
186024	(18-6024)	\$17.49 Z0-5780000

Zinc Anode



- Zinc.
- For all outboards.

Order No.	Mfg. No. / Description	List Price
269033	(C173)	\$5.69 G0-1830000

Sierra Anodes



- 9.9-115 HP, 1981-91.
- Replaces: 173029, 123009.

Order No.	Mfg. No. / Description	List Price
186017	(18-6017) Zinc	\$17.49 Z0-5780000
186100	(18-6100) Magnesium	\$17.49 Z0-7301000

Sierra Anodes



- 45-300 HP, 1988-90.
- Replaces: 431708.
- For use on Prop Shaft Bearing Carrier.

Order No.	Mfg. No. / Description	List Price
186095	(18-6095) Zinc	\$17.49 Z0-9401000
186095A	(18-6095A) Aluminum	\$17.49 Z0-9401000

Zinc Anode



- Zinc.
- 50-225 HP, 1991 to present.

Order No.	Mfg. No. / Description	List Price
269044	(433580)	\$18.99 G0-2721000

Zinc anodes should be use for saltwater applications.
 Aluminum anodes should be used for saltwater or brackish water applications.
 Magnesium anodes should be used for freshwater applications.

Johnson/Evinrude/OMC Anodes

Zinc Anode - Transom Bar



- Zinc.
- Length 7-5/8".
- Hole centers 6-15/16".

Order No.	Mfg. No. / Description	List Price
269034	(367)	\$8.39 GO-2650000

Sierra Anodes



- Replaces: 984513, 3853818, 3855412.

Order No.	Mfg. No. / Description	List Price
186028	(18-6028) Zinc	\$28.49 ZO-9071000
186028A	(18-6028A) Aluminum	\$28.49 ZO-9071000
186102	(18-6102) Magnesium	\$28.49 ZO-7961000

Sierra Zinc Anode



- Zinc.
- For: Cobra Lower Unit (1987) 2.5, 3.0, 4.3, 5.0, 5.7.
- Replaces: 983494.

Order No.	Mfg. No. / Description	List Price
186101	(18-6101)	\$28.49 ZO-7961000

Sierra Zinc Anode



- Zinc.
- Replace: 397768.

Order No.	Mfg. No. / Description	List Price
186029	(18-6029)	\$17.49 ZO-7301000

Sierra OMC Zinc Anode Kit



- Zinc.
- For: Cobra Drives except King Cobra.

Order No.	Mfg. No. / Description	List Price
186155Z	(18-6155Z)	\$103.99 ZO-9326000

Sierra Zinc Anode



- Zinc.
- Kit for V4 and V6. 1969-89. Replaces: 976669.

Order No.	Mfg. No. / Description	List Price
186020	(18-6020)	\$42.49 ZO-7352000

Zinc Anode - Low Profile



- Zinc.
- Low profile.

Order No.	Mfg. No. / Description	List Price
338128	(38554112)	\$22.39 GO-0051000

Sierra Zinc Anode



- Zinc.
- For intermediate housing on Stringer Drive models.
- Replaces: 982277, 982438.

Order No.	Mfg. No. / Description	List Price
186019	(18-6019)	\$35.49 ZO-9212000

Sierra OMC Anodes



- For use on Transom Mounts: 2.3L/3.0L (1987-89), 2.6L (1989).
- Replaces: 984547.

Order No.	Mfg. No. / Description	List Price
186103	(18-6103) Zinc	\$32.99 ZO-9791000
186103A	(18-6103A) Aluminum	\$30.99 ZO-9581000

- Electronics
- Trolling Motors
- Instruments
- Electrical
- Lighting
- Anchor & Dock
- Safety
- Steering, Controls
- Pumps
- Fuel System
- Seating & Pedestals
- Trailering
- Tops & Covers
- Perform.
- Propellers
- Engine & Care
- Cleaning & Care
- Paint & Paint Acc.
- Fun & Flotation
- Topside Acc.
- Cockpit & Deck
- Hardware, Fasteners
- Camouflage
- Misc.
- Comm.

Zinc anodes should be use for saltwater applications.
 Aluminum anodes should be used for saltwater or brackish water applications.
 Magnesium anodes should be used for freshwater applications.

Mercury/Mercruiser Anodes

Mercury Short Zinc Tab



- Zinc.
- Base OD 3-1/2"

Order No.	Mfg. No. / Description	List Price
269010	(31640)	\$7.39 GO-5940000

Mercury Racing Zinc Tab



- Zinc.

Order No.	Mfg. No. / Description	List Price
269027	(46399)	\$7.69 GO-5150000

Sierra Zinc Anode



- Zinc.
- For use on Alpha One SS (Sterndrive & Transom Assembly 1983-89) & prior drives.
- Replaces: 34762A1.

Order No.	Mfg. No. / Description	List Price
186013	(18-6013)	\$17.99 ZO-3701000

Mercury Outboard Zinc Anode



- Zinc.

Order No.	Mfg. No. / Description	List Price
269026	(76214)	\$6.29 GO-1240000

Mercury Zinc Waffle Plate



- Zinc.
- 75-115 HP.
- Dimensions: 7-5/8" x 2"

Order No.	Mfg. No. / Description	List Price
269028	(43396)	\$12.59 GO-4480000

Sierra Anodes



- Use on inline 3, 4 and 6 cylinder, V6.
- Replaces: 31640, 31640A1, 31640Q4.

Order No.	Mfg. No. / Description	List Price
186011	(18-6011) Zinc	\$15.49 ZO-2090000
186011A	(18-6011A) Aluminum	\$13.99 ZO-7280000
186241	(18-6241) Magnesium	\$19.49 ZO-6611000

Sierra Zinc Anode



- Zinc.
- For use on R/MR/Alpha One (Sterndrive & Transom Assembly 1983-90) and prior drives.
- Replaces: 34127A1, T2.

Order No.	Mfg. No. / Description	List Price
186012	(18-6012)	\$18.99 ZO-5111000

Mercruiser Zinc Anode



- Zinc.

Order No.	Mfg. No. / Description	List Price
268979	(34762)	\$3.79 GO-4520000

Sierra Anodes



- 200, 225, 250 HP, V-155 - V-200 and All Bravos.
- Replaces: Mercury Marine 76214, 76214T3, 76214Q5.

Order No.	Mfg. No. / Description	List Price
186016	(18-6016) Zinc	\$21.99 ZO-5921000
186016A	(18-6016A) Aluminum	\$23.49 ZO-5041000
186244	(18-6244) Magnesium	\$21.49 ZO-2821000

STANDARD PACKAGE OF 10 PRICED PER PIECE

Order No.	Mfg. No. / Description	List Price
1860161	(18-60161) Zinc	\$21.99 ZO-6921000



Zinc anodes should be use for saltwater applications.
 Aluminum anodes should be used for saltwater or brackish water applications.
 Magnesium anodes should be used for freshwater applications.

Mercury/Mercruiser Anodes

Sierra Anodes



- For use on transom mount bracket: 175HP/150EFI/200EFI (S/N OG303046 & Up).
- Replaces: 43396A2, A1, Q1.

Order No.	Mfg. No. / Description	List Price	
186249	(18-6249) Zinc	\$19.49	ZO-5511000
186249A	(18-6249A) Aluminum	\$19.49	ZO-5511000

Sierra Zinc Anode



- Zinc.
- Alpha One (Gen II).
- Replaces: 826134, Q.

Order No.	Mfg. No. / Description	List Price	
186068	(18-6068)	\$10.99	ZO-4460000

Sierra Anodes



- For: Alpha One, Gen II (1991 & Up).
- Replaces: 806189, A1, Q1, T1.

Order No.	Mfg. No. / Description	List Price	
186067	(18-6067) Zinc	\$12.99	ZO-9770000
186067A	(18-6067A) Aluminum	\$12.99	ZO-9770000
186114	(18-6114) Magnesium	\$12.99	ZO-9770000

Sierra Anodes



- For: Alpha One, Gen II (1991 & Up).
- Replaces: 806105, A1, Q1, T1.

Order No.	Mfg. No. / Description	List Price	
186079	(18-6079) Magnesium	\$20.99	ZO-1421000
186093A	(18-6093A) Aluminum	\$20.99	ZO-9521000

Sierra Anodes



- For: Alpha One, Gen II (1991 & Up).
- Replaces: 821629, A1, Q1.

Order No.	Mfg. No. / Description	List Price	
186080	(18-6080) Zinc	\$32.49	ZO-4491000
186080A	(18-6080A) Aluminum	\$32.49	ZO-4491000
186099	(18-6099) Magnesium	\$29.99	ZO-3971000

Zinc Anode

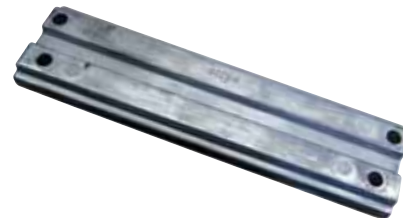

- Zinc.

Order No.	Mfg. No. / Description	List Price	
269004	(818298)	\$8.39	GO-2650000

Zinc Anode



- Zinc.
- 90-120 HP.
- 2 required.

Order No.	Mfg. No. / Description	List Price	
269005	(826134)	\$4.49	GO-1030000

Zinc Anode



- Zinc.

Order No.	Mfg. No. / Description	List Price	
269000	(806189)	\$2.29	GO-3510000

Zinc Anode



- Zinc.

Order No.	Mfg. No. / Description	List Price	
268983	(806105)	\$10.09	GO-6760000

Zinc Anode



- Zinc.

Order No.	Mfg. No. / Description	List Price	
269002	(815933)	\$10.39	GO-6960000

Zinc anodes should be use for saltwater applications.
 Aluminum anodes should be used for saltwater or brackish water applications.
 Magnesium anodes should be used for freshwater applications.

Mercury/Mercruiser Anodes

Sierra Anodes



- Bravo I, II, III, 1988-95.
- Replaces: 55989A3, Q9, T9.

STANDARD PACKAGE OF 2 PRICED PER PIECE

Order No.	Mfg. No. / Description	List Price	
186015	(18-6015-9) Zinc	\$27.99	ZO-9761000
186015A	(18-6015A-9) Aluminum	\$28.99	ZO-9371000
1862429	(18-6242-9) Magnesium	\$27.99	ZO-9761000

STANDARD PACKAGE OF 10 PRICED PER PIECE

Order No.	Mfg. No. / Description	List Price	
18601519	(18-60151-9) Zinc	\$25.59	ZO-4971000
186015A9	(18-6015A-9) Aluminum	\$28.99	ZO-9371000

Sierra Anodes



- For use on R/MR/Alpha One (Sterndrive & Transom Assembly 1983-90).
- Replaces: 43994A2, 821631Q1.

Order No.	Mfg. No. / Description	List Price	
186066	(18-6066) Zinc	\$26.99	ZO-5951000
186066A	(18-6066A) Aluminum	\$28.99	ZO-4271000
186243	(18-6243) Magnesium	\$26.99	ZO-5951000

Sierra Anodes



- All Bravos.
- Replaces: 821630, A1, Q1, T1.

Order No.	Mfg. No. / Description	List Price	
186094	(18-6094) Zinc	\$29.99	ZO-9971000
186094A	(18-6094A) Aluminum	\$29.99	ZO-9971000
186240	(18-6240) Magnesium	\$29.99	ZO-3971000

Zinc Anode



- Zinc.

Order No.	Mfg. No. / Description	List Price	
269003	(817373)	\$10.39	G0-6960000

Sierra Anodes



- Bravo One Bearing Carrier.
- Replaces: 806188A1, A2.

Order No.	Mfg. No. / Description	List Price	
186117Z	(18-6117Z) Zinc	\$27.99	ZO-5661000
186117A	(18-6117A) Alum.	\$25.99	ZO-5351000
186117M	(18-6117M) Mag.	\$12.95	ZO-4190000

Mercruiser Zinc Nut



- Zinc.
- 1-1/4" OD, Length 1-1/8".

Order No.	Mfg. No. / Description	List Price	
269084	(55989)	\$1.99	G0-3310000

Zinc Anode

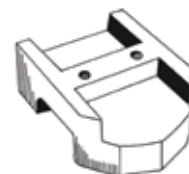

- Zinc.

Order No.	Mfg. No. / Description	List Price	
269007	(821631)	\$17.79	G0-2911000

Zinc Anode



- Zinc.
- Dimensions: 3-3/4" x 3".

Order No.	Mfg. No. / Description	List Price	
269030	(43994)	\$16.69	G0-8111000

Zinc Anode



- Zinc.

Order No.	Mfg. No. / Description	List Price	
269006	(821630)	\$10.69	G0-6170000

Zinc Anode



- Zinc.

Order No.	Mfg. No. / Description	List Price	
268990	(806188)	\$9.19	G0-6160000

Zinc anodes should be use for saltwater applications.
Aluminum anodes should be used for saltwater or brackish water applications.
Magnesium anodes should be used for freshwater applications.

Mercury/Mercruiser Anodes

Sierra Anodes



- All Bravos.
- Replaces: 806190, A1, Q1, T1.

Order No.	Mfg. No. / Description	List Price	ZO-Part No.
186092	(18-6092) Zinc	\$29.49	ZO-6671000
186092A	(18-6092A) Aluminum	\$29.49	ZO-6671000
186089	(18-6089) Magnesium	\$26.49	ZO-1751000

Zinc Anode



- Zinc.

Order No.	Mfg. No. / Description	List Price	ZO-Part No.
269001	(806190)	\$4.19	GO-1820000

Mercury/Mercruiser Anode Kits

Sierra MR and Alpha I Anode Kits



- MR and Alpha I Drives.

Order No.	Mfg. No. / Description	List Price	ZO-Part No.
186150A	(18-6150A) Aluminum	\$51.26	ZO-2333000
186150M	(18-6150M) Magnesium	\$76.99	ZO-9164000
186150Z	(18-6150Z) Zinc	\$51.26	ZO-2333000

Martyr Alpha I Generation I Anode Kit



- Aluminum
- Fits Alpha I Generation I Engine 1983-1990.
- Contains: (1) CM31640, (2) CM55989, and (1) CM821631.

Order No.	Mfg. No. / Description	List Price	ZO-Part No.
620164	(ALPHAGEN1KTA)	\$31.79	GO-0312000

Sierra Alpha I Gen II Anode Kits



- Alpha I Gen II (1991 and up).

Order No.	Mfg. No. / Description	List Price	ZO-Part No.
186158A	(18-6158A) Aluminum	\$86.99	ZO-9125000
186158M	(18-6158M) Magnesium	\$134.99	ZO-9908000
186158Z	(18-6158Z) Zinc	\$86.99	ZO-9125000

Martyr Alpha I Generation II Anode Kits



- Fits Alpha I Generation II Engine 1991-Present.
- Contains: (1) CM762145, (1) CM806105, (1) CM821629, (1) CM821631 and (2) CM806189.

Order No.	Mfg. No. / Description	List Price	ZO-Part No.
6202225	(ALPHA-KIT-M) Magnesium	\$103.59	GO-1496000
620163	(CMALPHA-KITA) Aluminum	\$57.99	GO-5883000

Sierra Bravo I Anode Kits



- Bravo I (all years).

Order No.	Mfg. No. / Description	List Price	ZO-Part No.
186159A	(18-6159A) Aluminum	\$84.15	ZO-0745000
186159M	(18-6159M) Magnesium	\$110.75	ZO-9917000
186159Z	(18-6159Z) Zinc	\$84.15	ZO-0745000

Martyr Bravo I Anode Kit

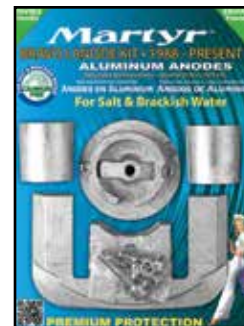

- Fits Bravo I Engine 1988-Present.
- Contains: (1) CM762145, (1) CM806188, (1) CM821630 and (2) CM806190.

Order No.	Mfg. No. / Description	List Price	ZO-Part No.
620162	(CMBRAVO1KITA) Aluminum	\$44.79	GO-1003000

- Electronics
- Trolling Motors
- Instruments
- Electrical
- Lighting
- Anchor & Dock
- Safety
- Steering, Controls
- Pumps
- Fuel System
- Seating & Pedestals
- Trailer
- Tops & Covers
- Perform.
- Propellers
- Engine & Care
- Cleaning & Care
- Paint & Paint Acc.
- Fun & Flotation
- Topside Acc.
- Cockpit & Deck
- Hardware, Fasteners
- Camouflage
- Misc.
- Comm.



Zinc anodes should be use for saltwater applications.
Aluminum anodes should be used for saltwater or brackish water applications.
Magnesium anodes should be used for freshwater applications.

Mercury/Mercruiser Anode Kits

Sierra Bravo II and III Anode Kits



- Bravo II (1989 and up) and III (1989-2003).

Order No.	Mfg. No. / Description	List Price
186160A	(18-6160A) Aluminum	\$67.99 Z0-9014000
186160M	(18-6160M) Magnesium	\$101.02 Z0-6656000
186160Z	(18-6160Z) Zinc	\$68.49 Z0-9014000

Sierra Bravo III Anode Kits



- Bravo III (2004 and newer).

Order No.	Mfg. No. / Description	List Price
186154A	(18-6154A) Aluminum	\$85.49 Z0-9215000
186154M	(18-6154M) Magnesium	\$129.99 Z0-9977000
186154Z	(18-6154Z) Zinc	\$85.49 Z0-9215000

Martyr Bravo II and III Anode Kits



- Fits Bravo II 1989-Present & Bravo III 1989-2003.
- Contains: (1) CM762145, (1) CM821630 and (2) CM806190.

Order No.	Mfg. No. / Description	List Price
6202229	(BRAVO-23-KTM) Magnesium	\$85.09 G0-1075000
620168	(BRAVO-23-KTA) Aluminum	\$39.39 G0-9362000

Martyr Bravo III Anode Kits

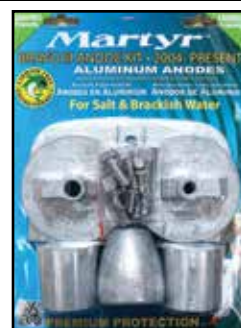

- Fits Bravo III 2004-Present.
- Contains: (1) CM762144, (1) CM762145, (1) CM865182C, (1) CM821630 and (2) CM806190.

Order No.	Mfg. No. / Description	List Price
6202231	(BRAVO-3-KT-M) Magnesium	\$108.09 G0-2427000
620170	(BRAVO-3-KT-A) Aluminum	\$50.89 G0-0143000

Sierra Verado 4 Anode Kits



- Verado 4 Cylinder, all models.

Order No.	Mfg. No. / Description	List Price
186156A	(18-6156A) Aluminum	\$69.99 Z0-9914000
186156M	(18-6156M) Magnesium	\$119.99 Z0-9917000

Sierra Verado 6 Anode Kits



- Verado 6 Cylinder, all models.

Order No.	Mfg. No. / Description	List Price
186157A	(18-6157A) Aluminum	\$89.99 Z0-9935000
186157M	(18-6157M) Magnesium	\$94.49 Z0-9665000

Martyr Verado Aluminum Anode Kit



- Aluminum
- Verado 4/OPTIMAX Engine.
- Contains: (1) CM818298, (2) CM826134 and (1) CM762145.

Order No.	Mfg. No. / Description	List Price
620165	(VERADO4-KT-A)	\$57.69 G0-5683000

Martyr Verado Aluminum Anode Kit



- Aluminum
- Verado 6 Engine.
- Contains: (1) CM880653, (4) CM892227, (2) CM826134 and (1) CM762145.

Order No.	Mfg. No. / Description	List Price
620167	(VERADO6-KT-A)	\$56.59 G0-2973000



Sierra Anode Kits



- Fits: 90-140 HP.

Order No.	Mfg. No. / Description	List Price	ZO-Part No.
186161A	(18-6161A) Aluminum	\$23.49	ZO-9041000
186161M	(18-6161M) Magnesium	\$41.49	ZO-9842000



- Aluminum.
- Replaces: 875815.

Order No.	Mfg. No. / Description	List Price	ZO-Part No.
186009A	(18-6009A)	\$28.49	ZO-9071000

Sierra Zinc Anode



- Zinc.
- Transom shield.
- Replaces: 873395.

Order No.	Mfg. No. / Description	List Price	ZO-Part No.
186123Z	(18-6123Z)	\$25.99	ZO-9551000

Zinc Anode

- Zinc.
- Fits: 290B HP.
- Length 5-1/4".

Order No.	Mfg. No. / Description	List Price	ZO-Part No.
269286	(852835)	\$27.29	G0-8281000



- Fits: 200, 250, 250C, 250D, 270, 270B, 270C, 270D, 275, 280, 280C, 280D, 280DP, 280L, 280PT.
- Replaces: 832598, 873179.

Order No.	Mfg. No. / Description	List Price	ZO-Part No.
186104	(18-6104) Magnesium	\$30.99	ZO-5381000
186000A	(18-6000A) Aluminum.	\$30.99	ZO-5381000

Sierra Zinc Anode



- Zinc.
- DPS Steering Arm.
- Replaces: 872793.

Order No.	Mfg. No. / Description	List Price	ZO-Part No.
186124Z	(18-6124Z)	\$9.89	ZO-0960000

Sierra Anodes



- Fits: 290, 290A, 290ADP, 290B.
- Replaces: 852835, 873178.

Order No.	Mfg. No. / Description	List Price	ZO-Part No.
186105	(18-6105) Magnesium	\$28.87	ZO-5612000
186004A	(18-6004A) Aluminum	\$26.99	ZO-1061000

- Trolling Motors
- Instruments
- Electrical
- Lighting
- Anchor & Dock
- Safety
- Steering, Controls
- Pumps
- Fuel System
- Seating & Pedestals
- Trailering
- Tops & Covers
- Perform.
- Propellers
- Engine & Care
- Cleaning & Care
- Paint & Paint Acc.
- Fun & Flotation
- Topside Acc.
- Cockpit & Deck
- Hardware, Fasteners
- Camouflage
- Misc.
- Comm.

Zinc anodes should be use for saltwater applications.
Aluminum anodes should be used for saltwater or brackish water applications.
Magnesium anodes should be used for freshwater applications.

Volvo Anodes

Zinc Anode

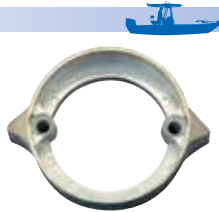

- Zinc.
- For Models: Duo Prop.

Order No.	Mfg. No. / Description	List Price	
269292	(875821)	\$15.39	GO-1301000

Sierra Anodes



- Fits: 280DP, 290DP HP.
- Replaces: 875821.

Order No.	Mfg. No. / Description	List Price	
186010	(18-6010) Zinc	\$51.99	ZO-6533000
186010A	(18-6010A) Aluminum	\$51.99	ZO-6533000
186106	(18-6106) Magnesium	\$37.49	ZO-5222000

Sierra Anodes



- Replaces: 3855411, 984513 (18-6028), 3863193 (18-6028A), 3854412 (18-6102).

Order No.	Mfg. No. / Description	List Price	
186028	(18-6028) Zinc	\$28.49	ZO-9071000
186028A	(18-6028A) Aluminum	\$28.49	ZO-9071000
186102	(18-6102) Magnesium	\$28.49	ZO-7961000

Sierra Anodes



- Transom Plate.
- Replaces: 3586461 (Aluminum), 3855610 (Magnesium) and 3854130 (Zinc).

Order No.	Mfg. No. / Description	List Price	
186125A	(18-6125A) Aluminum	\$38.99	ZO-9332000
186125M	(18-6125M) Magnesium	\$59.99	ZO-5753000
186125Z	(18-6125Z) Zinc	\$32.49	ZO-9491000

Sierra Zinc Anode



- For Fresh Water Cooler.
- Fits: AQ200 (For shield), MD19, 21, 27, 29, 32, 2003, AQ30, 31, 40, 41.
- Replaces: 838929.

Order No.	Mfg. No. / Description	List Price	
186001	(18-6001)	\$10.99	ZO-7460000

Sierra Transom Anodes with Bolt



- SX-A, DPS-A, DPS-A Oxi.
- Replaces: 3888816 (Aluminum), 3888818 (Magnesium), 3888817 (Zinc).

Order No.	Mfg. No. / Description	List Price	
186126A	(18-6126A) Aluminum	\$33.49	ZO-9002000
186126M	(18-6126M) Magnesium	\$43.49	ZO-7952000
186126Z	(18-6126Z) Zinc	\$41.02	ZO-6662000

Sierra Transom Anodes with Bolt



- SX-A, DPS-A, DPS-A Oxi.
- Replaces: 3888813 (Aluminum), 3888815 (Magnesium), 3888814 (Zinc).

Order No.	Mfg. No. / Description	List Price	
186127A	(18-6127A) Aluminum	\$38.99	ZO-7232000
186127M	(18-6127M) Magnesium	\$51.49	ZO-5603000
186127Z	(18-6127Z) Zinc	\$18.79	ZO-0131000

Martyr Anode Kit



- Fits Volvo SX Engine.
- Contains: (1) CM3855411 and (1) CM3854130.

Order No.	Mfg. No. / Description	List Price	
620173	(SX-KIT-A) Aluminum	\$54.29	GO-7363000



Zinc anodes should be used for saltwater applications.
Aluminum anodes should be used for saltwater or brackish water applications.
Magnesium anodes should be used for freshwater applications.

Yamaha Anodes

Zinc Anode



- Zinc.
- Fits: 225-250 HP.

Order No.	Mfg. No. / Description	List Price
338093	(61A45371)	\$9.49

Sierra Anodes



- Replaces: 61A-45371-00-00.

Order No.	Mfg. No. / Description	List Price
186119A	(18-6119A) Alum.	\$28.99
186119Z	(18-6119Z) Zinc	\$29.99

Zinc Anode



- Zinc.
- Standard rotation.

Order No.	Mfg. No. / Description	List Price
269297	(6K1-45371-00)	\$25.29

Zinc Anode



- Zinc.
- Counter rotation.

Order No.	Mfg. No. / Description	List Price
269298	(6K1-45371-02)	\$26.99

Sierra Anodes



- Fits: FL150 (2004-05); L150 - L200 (1987-02).
- Replaces: 6K1-45371-02-00.

Order No.	Mfg. No. / Description	List Price
186121A	(18-6121A) Alum.	\$34.49
186121Z	(18-6121Z) Zinc	\$32.99

Sierra Zinc Anode



- Zinc.
- Fits: 150-200 HP (1986).
- Replaces: 6K1-45371-00-00.

Order No.	Mfg. No. / Description	List Price
186034	(18-6034)	\$50.49

Sierra Anodes



- Fits: 150-200 HP and F150 HP (1986-06).
- Replaces: 6J9-45371-01-00.

Order No.	Mfg. No. / Description	List Price
186112	(18-6112) Mag.	\$23.49
186035	(18-6035) Zinc	\$24.99

Zinc Anode



- Zinc.
- Fits: 150-200 HP.

Order No.	Mfg. No. / Description	List Price
338118	(6J9-45371)	\$11.69

Sierra Anodes



- Fits: VZ200-VZ300/3.3L (2005-Current), VX225-VX250/2.6L (2002-05), Z250 - Z300/3.3L (2004-Current).
- Replaces: 69L-45371-00-00.

Order No.	Mfg. No. / Description	List Price
186122A	(18-6122A) Alum.	\$30.49
186122Z	(18-6122Z) Zinc	\$31.99

Zinc Anode



- Zinc.
- Fits: 70 HP.

Order No.	Mfg. No. / Description	List Price
338120	(688-45371-02)	\$14.69

Sierra Anodes



- Fits: 60, 70, 90 HP (1984-04) C60, C75, C85, C90 (1994-01), E60, E75 (1995-00), F50 (1996-00), P60, P75 (1991-99), T50 (1996-00).
- Replaces: 688-45371-02-00.

Order No.	Mfg. No. / Description	List Price
186111	(18-6111) Mag.	\$20.99
186070	(18-6070) Zinc	\$19.99

Sierra Zinc Anode



- Zinc.
- Fits: 40-90 HP.
- Replaces: 6H1-45251-02-00.

Order No.	Mfg. No. / Description	List Price
186091	(18-6091)	\$18.49

Sierra Trim Tab Bolt



- M10 - 1.25 x 45mm thread.
- Replaces: 90105-10M00-00.

Order No.	Mfg. No. / Description	List Price
186246	(18-6246)	\$6.19

Sierra Zinc Anode



- Zinc.
- Fits: 150-200 HP (1986-06).
- Replaces: 6G5-45251-01-00.

Order No.	Mfg. No. / Description	List Price
186090	(18-6090)	\$26.99

Zinc Anode



- Zinc.
- Fits: 115-200 HP.

Order No.	Mfg. No. / Description	List Price
338106	(6G5-45251)	\$15.19

Zinc anodes should be use for saltwater applications.
 Aluminum anodes should be used for saltwater or brackish water applications.
 Magnesium anodes should be used for freshwater applications.



- Zinc.
- 90-200 HP.
- Base OD 3-5/8".

Order No.	Mfg. No. / Description	List Price
269295	(6E5-45371-10)	\$20.49



- Zinc.
- 115-130 HP, 1984-04 and V6 Special 1984-86.
- Replaces: 6E5-45371-01-00.

Order No.	Mfg. No. / Description	List Price
186097	(18-6097)	\$35.49



- Zinc.
- For: 20-50 HP.
- Replaces: 664-45371-01-00.

Order No.	Mfg. No. / Description	List Price
186096	(18-6096)	\$11.99

- Electronics
- Trolling Motors
- Instruments
- Electrical
- Lighting
- Anchor & Dock
- Safety
- Steering, Controls
- Pumps
- Fuel System
- Seating & Pedestals
- Trailering
- Tops & Covers
- Perform.
- Propellers
- Engine & Care
- Paint & Paint Acc.
- Fun & Flotation
- Topside Acc.
- Cockpit & Deck
- Hardware, Fasteners
- Camouflage
- Misc.
- Comm.

Sierra Anodes



- Gearcase anode.
- Replaces: 61N-45251-01-00.

Order No.	Mfg. No. / Description	List Price
186120Z	(18-6120Z) Zinc	\$14.99

Sierra Cylinder Block Anode



- Aluminum.
- Fits: F75-F250 / 2004 through April 2006 Production.
- Replaces: 68V-11325-01-00.

Order No.	Mfg. No. / Description	List Price
186118A	(18-6118A)	\$21.99

Sierra Anode Kits



- Fits: 60-90 HP Outboards.

Order No.	Mfg. No. / Description	List Price
186162M	(18-6162M) Mag.	\$60.99

Sierra Anode Kits



- Fits: 200-250 HP Outboards.

Order No.	Mfg. No. / Description	List Price
186132M	(18-6132M) Mag.	\$52.49

Sierra Anode Kits



- Fits: 150-200 HP Outboards.

Order No.	Mfg. No. / Description	List Price
186133M	(18-6133M) Mag.	\$49.49

Martyr Anode Kit



- Aluminum.
- Fits Yamaha 150-200 HP Outboards.
- Contains: (1) CM6G54525101 (1) CM6J94537101

Order No.	Mfg. No. / Description	List Price
620181	(Y150-KIT-A)	\$32.59

Martyr Anode Kit



- Aluminum.
- Fits Yamaha 200-250 HP Outboards.
- Contains: (1) CM6G54525101 (1) CM61A4537100

Order No.	Mfg. No. / Description	List Price
620183	(Y200250-KT-A)	\$33.99

Martyr Anode Kit



- Aluminum.
- Fits Yamaha High Performance 200-300 HP Outboards.
- Contains: (1) CM6G54525101 (1) CM69L4537100

Order No.	Mfg. No. / Description	List Price
620185	(Y200300-KT-A)	\$33.89

Newmar Galvanic Isolators



- Sacrificial zincs corrode away as they protect metal thru hulls, shafts and props from damaging electrolysis.
- Stray, low voltage current flowing between the AC safety ground and DC bonding system is a principal cause of this "galvanic" action.
- Installing the Galvanic Isolator between the AC safety ground and DC bonding system, blocks a majority of the low voltage currents and corrosive action on the zincs is significantly reduced (while the integrity of the critical safety ground path is maintained.)

Order No.	Mfg. No. / Description	List Price
699902	(GI-30) 30 amps, Dim.: 2.7" H x 4.8" W x 7.3" D	\$278.89
699905	(GI-50) 50 amps, Dim.: 4.5" H x 4.7" W x 8.9" D	\$335.79