

Catálogo de accesorios Náuticos



Trolling
Motors



Instruments



Electrical



Lighting



Anchor
& Dock



Safety



Steering,
Controls



Pumps



Fuel
System



Seating &
Pedestals



Trailer



Tops &
Covers



2021

Parte 1

El Navegante

www.repuestoselnavegante.com



- Trolling Motors
- Instruments
- Electrical
- Lighting
- Anchor & Dock
- Safety
- Steering, Controls
- Pumps
- Fuel System
- Seating & Pedestals
- Trailer
- Tops & Covers
- Perform.
- Propellers
- Engine & Care
- Cleaning & Care
- Paint & Paint Acc.
- Fun & Flotation
- Topside Acc.
- Cockpit & Deck
- Hardware, Fasteners
- Camouflage
- Misc.
- Comm.

Bienvenidos a Repuestos El Navegante.

Aquí podrás encontrar mas de **35.000** productos de diferentes fabricantes, con una gran variedad de accesorios y componentes para tu embarcación, contamos con mas de 20 años de experiencia en el sector náutico, no dudes en contactarnos para aclarar cualquier duda que tengas, prestamos asesoría técnica lo que es un valor agregado, y te dará tranquilidad a la hora de tomar una decisión de compra.

Nota Importante:

Debido a las restricciones causadas por el Covid 19, y otros problemas a nivel Mundial muchas empresas se vieron afectadas debido a la falta de materia prima, por este motivo tanto los precios como las fechas de entrega sufrieron cambios en gran cantidad de productos, comuníquese con nosotros a través del correo: repuestoselnavegante@gmail.com y solicite su presupuesto sin compromiso, también puede comunicarse vía Telegram o WhatsApp escaneando los códigos QR.

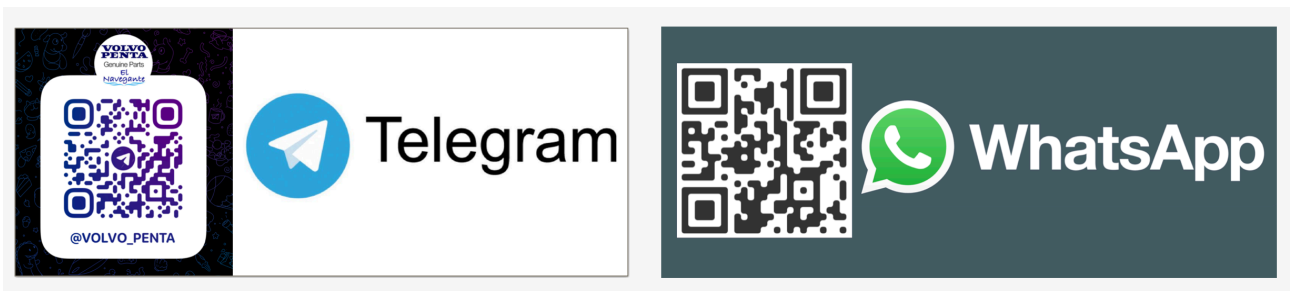

Los productos aquí publicados se encuentran en varias partes del mundo, pero la mayoría se encuentran en Estados Unidos y Europa, por lo que estos precios no incluyen gastos de envío.

También puede consultar en nuestra pagina www.repuestoselnavegante.com nuestros términos y condiciones antes de efectuar la compra, ahí podrá ver también nuestra política de devoluciones.

Los productos pueden ser entregados en un currier de su confianza.

En nuestra pagina podrá encontrar mas de **3.500** productos para entrega inmediata.

Nos especializamos en repuestos Volvo Penta, Cummings, Yanmar, Caterpillar, Mercruiser.

Ofrecemos repuestos para Generadores Onan, Kohler, Westerbeke, Fisher Panda y Northern Lights.

L.E.D. Trailer and Tail Light Kits for Trailers Over 80" Wide

Tough Guy L.E.D. Waterproof Trailer Light Kit - Trailers Over 80" Wide



- Limited LED lifetime warranty - if LED fails, we'll replace it.
- Brighter than standard conventional bulbs.
- Uses 90% less energy. 100% sealed, never replace a bulb.
- LED's rated at 100,000 hours (that's 48 years at 40 hours per week).
- Kit includes: 2 LED low profile universal-mount tail lights with red side markers/reflectors, license plate bracket, 25' wiring harness and stainless steel hardware.

Order No.	Description	List Price	
7-0012	LED Waterproof Trailer Light Kit	\$74.29	GO-7794000
7-59342	Right Side Tail Light Only	\$26.69	GO-8871000
7-59344	Left Side Tail Light Only with Illuminator	\$28.89	GO-6391000

Optronics L.E.D. ONE™ Low Profile Tail Light Kit - Trailers Over 80" Wide



- Designed for marine trailer application.
- Universal mount.
- Sealed, waterproof construction.
- Hard wired with separate ground wire.
- Includes: (2) LED combination tail lights and mounting hardware.

Order No.	Mfg. No. / Description	List Price	
522766	(TLL0016RK) Tail Light Kit	\$50.59	HO-5303000
522772	(STL0016RS) Right (Passenger Side)	\$27.99	HO-9761000
522774	(STL0017RS) Left (Driver Side)	\$30.49	HO-9281000

Tough Guy L.E.D. Waterproof Trailer Light Kit - Trailers Over 80" Wide



- For trailers over 80" wide.
- Includes: Wire harness, license plate bracket, frame clips, stainless steel hardware.

Order No.	Description	List Price	
7-59387	LED Waterproof Trailer Light Kit	\$78.89	GO-6825000
7-59389	Right Side Tail Light Only	\$27.79	GO-2681000
7-59388	Left Side Tail Light Only with Illuminator	\$32.99	GO-0122000

Optronics L.E.D. Waterproof Trailer Light Kit - Trailers Over 80" Wide



- Designed for marine trailer applications.
- Universal mount.
- Sealed, waterproof construction.
- Hard wired, with separate ground wire.
- Includes: (2) LED combination tail lights, 25' harness, license plate bracket and stainless steel mounting hardware.

Order No.	Mfg. No. / Description	List Price	
522820	(TLL-56RK) Trailer Light Kit	\$120.69	HO-1427000

Trailer Light Kits for Trailers Over 80" Wide

Optronics Waterproof Trailer Light Kit (Low Profile) - Trailers Over 80" Wide



- Waterproof, low profile design for marine applications.
- Mount on 2" centers.
- Acrylic lens, corrosion proof plastic housing.
- Passenger side light is 7 function: Stop, turn, tail, rear clearance, rear reflex, side marker and side reflex.
- Driver side light also includes license illuminator.
- Includes: (2) combination tail lights, (2) MC91AB yellow marker lights with bases, (2) RE11AB yellow reflectors, 25' harness, license plate bracket and stainless steel mounting hardware.

Order No.	Mfg. No. / Description	List Price	
522954	(TL-16RK) Trailer Light Deluxe Kit	\$59.49	HO-9653000
522955	(ST-16RS) Right (Passenger Side)	\$16.99	HO-9101000
522967	(ST-17RS) Left (Driver Side) with Illuminator	\$16.89	HO-3101000

Tough Guy Low Profile Trailer Light Kit - Trailers Over 80" Wide



- Submersible multi-function light kit includes right and left tail lights, 25' wishbone wiring harness, 48" trunk connector, license plate bracket and mounting hardware.
- Clam pack.

Order No.	Description	List Price	
7-59306	Trailer Light Kit	\$43.49	GO-4192000
7-59304	Right Side Tail Light Only	\$11.99	GO-3080000
7-59305	Left Side Tail Light Only	\$13.99	GO-9380000

Wesbar Waterproof Low Profile Tail Lights - Trailers Over 80" Wide

- Featuring a reliable waterproof design, these lights have a bulb replaceable capsule that protects the bulbs from corrosion and thermal shock but still allows for easy access for bulb replacement.
- These lights meet DOT 108 requirements for trailers over 80" wide when properly mounted.



Order No.	Mfg. No. / Description	List Price	
684755	(403076) Right, 7 Function Tail Light	\$19.09	HO-5411000
684743	(403026) Left, 8 Function Tail Light	\$19.29	HO-7511000
685315	(403336) Replacement Lens Set, Tail and Side	\$13.39	HO-3080000

- Electronics
- Trolling Motors
- Instruments
- Electrical
- Lighting
- Anchor & Dock
- Safety
- Steering, Controls
- Pumps
- Fuel System
- Seating & Pedestals
- Trailer
- Tops & Covers
- Perform.
- Propellers
- Engine & Care
- Cleaning & Care
- Paint & Paint Acc.
- Fun & Flotation
- Topside Acc.
- Cockpit & Deck
- Hardware, Fasteners
- Camouflage
- Misc.
- Comm.

Tail Lights for Trailers Over 80" Wide

Optronics Waterproof Tail Lights (Low Profile) - Trailers Over 80" Wide



- Waterproof, low profile design for marine applications.
- Screw-on lens, easy to change bulbs.
- Mount on 2" centers.
- Includes separate ground wire with eyelet.
- Acrylic lens, corrosion proof plastic housing.
- Passenger side light is 7 function: Stop, turn, tail, rear clearance, rear reflex, side marker and side reflex.
- Driver side light also includes license illuminator.

Order No.	Mfg. No. / Description	List Price	
522970	(ST-36RS) Right (Passenger Side)	\$17.09	H0-5201000
522972	(ST-37RS) Left (Driver Side) with Illuminator	\$17.59	H0-5501000

Optronics Submersible Tail Lights - Trailers Over 80" Wide



- Submersible design suitable for many applications.
- Screw-on lens, easy to change bulbs.
- Stud mount on 2" centers.
- Shock-proof socket guarantees long bulb life.
- Acrylic lens, corrosion proof plastic housing.
- Passenger side light is 7 function: Stop, turn, tail, rear clearance, rear reflex, side marker and side reflex.
- Driver side light also includes license illuminator.

Order No.	Mfg. No. / Description	List Price	
522917	(ST-4RS) Right (Passenger Side)	\$14.29	H0-7580000
522929	(ST-5RS) Left (Driver Side) with Illuminator	\$14.49	H0-9680000

Optronics Submersible Tail Lights - Trailers Over 80" Wide



- Waterproof design for marine applications.
- Mount on 2" centers.
- Includes separate ground wire with eyelet.
- Acrylic lens, corrosion proof plastic housing.
- Passenger side light is 7 function: Stop, turn, tail, rear clearance, rear reflex, side marker and side reflex.
- Driver side light also includes license illuminator.

Order No.	Mfg. No. / Description	List Price	
684775	(ST-56RS) Right (Passenger Side)	\$12.99	H0-9770000
684763	(ST-57RS) Left (Driver Side) with Illuminator	\$13.19	H0-1970000

Tough Guy Tail Lights - Trailers Over 80" Wide



- For trailers over 80" wide.
- Incandescent bulb.
- Includes stainless steel mounting hardware.
- Clam pack.

Order No.	Description	List Price	
7-59298	Right Side Tail Light Only	\$8.89	G0-6950000
7-59299	Left Side Tail Light Only	\$9.19	G0-6160000

L.E.D. Trailer and Tail Light Kits for Trailers Under 80" Wide

Tough Guy L.E.D. Waterproof Trailer Light Kit - Trailers Under 80" Wide



- Limited LED lifetime warranty - if LED fails, we'll replace it.
- Brighter than standard conventional bulbs. Uses 90% less energy.
- 100% sealed, never replace a bulb.
- LED's rated at 100,000 hours (that's 48 years at 40 hours per week).
- Kit includes: 2 LED stud-mount tail lights with red side markers/reflectors, license plate bracket, 25' wiring harness and plated hardware.

Order No.	Description	List Price	
7-0011	LED Waterproof Trailer Light Kit	\$75.79	G0-8705000
7-59332	Right Side Tail Light Only	\$25.19	G0-8861000
7-59334	Left Side Tail Light Only	\$36.89	G0-2742000

Optronics L.E.D. ONE™ Combination Tail Light Kit - Trailers Under 80" Wide



- Sealed, waterproof design.
- Traditional style fits many applications.
- Stud mount lights mount on 2" center.
- Hard wired, includes separate ground wire.
- Includes: (2) LED combination tail lights and mounting hardware.

Order No.	Mfg. No. / Description	List Price	
522770	(TLL008RK) Tail Light Kit	\$39.79	H0-7832000
522778	(STL008RS) Right (Passenger Side)	\$24.89	H0-3941000
522780	(STL009RS) Left (Driver Side) with Illuminator	\$26.19	H0-1751000

L.E.D. Tail Lights for Trailers Under 80" Wide

Optronics L.E.D. Combination Tail Lights - Trailers Under 80" Wide



- Traditional style fits many applications.
- Stud mount lights mount on 2" centers.
- Hard wired, with separate ground wire.

Order No.	Mfg. No. / Description	List Price	
522787	(STL-6RS) Right (Passenger Side)	\$44.99	H0-9962000
522789	(STL-7RS) Left (Driver Side) with Illuminator	\$49.79	H0-7892000

Trailer Light Kits and Tail Lights for Trailers Under 80" Wide

Tough Guy Submersible Trailer Light Kit - Trailers Under 80" Wide



- Meets all SAE/DOT specifications for under 80" wide trailers when properly installed.
- Includes: Tail lights, wiring harness, license plate bracket, mounting hardware and complete instructions.

Order No.	Description	List Price	
7-0013	Submersible Trailer Light Kit	\$31.39	GO-3012000
7-59301	Right Side Tail Light Only	\$6.39	GO-8240000
7-59302	Left Side Tail Light Only	\$6.99	GO-8640000

Tough Guy Trailer Light Kit - Trailers Under 80" Wide



- For under 80" wide trailers.
- Includes: License plate bracket and stainless steel mounting hardware.
- Harness not included.

Order No.	Description	List Price	
7-59294	Submersible Trailer Light Kit	\$18.19	GO-9121000

Optronics Submersible Trailer Light Kit - Trailers Under 80" Wide



- Submersible design suitable for many applications.
- Screw-on lens, easy to change bulbs.
- Stud mount on 2" centers.
- Grounds through mounting studs.
- Acrylic lens, corrosion proof plastic housing.
- Passenger side light is 6 function: Stop, turn, tail, rear reflex, side marker and side reflex.
- Driver side light also includes license illuminator.
- Includes: (2) submersible tail lights, 25' harness, license plate bracket and mounting hardware.

Order No.	Mfg. No. / Description	List Price	
522951	(TL-9RK) Trailer Light Kit	\$39.59	HO-5732000

Optronics Economy Tail Lights - Trailers Under 80" Wide



- Screw-on lens, easy to change bulbs.
- Stud mount on 2" centers.
- Grounds through mounting studs.
- Acrylic lens, corrosion proof plastic housing.
- Designed with Plug-n-go connections for quick connect wiring.
- Passenger side light is 6 function: Stop, turn, tail, rear reflex, side marker and side reflex.
- Driver side light also includes license illuminator.

Order No.	Mfg. No. / Description	List Price	
522931	(ST-8RS) Right (Passenger Side)	\$10.99	HO-9560000
522943	(ST-9RS) Left (Driver Side) Illuminator	\$11.19	HO-1760000

L.E.D. Stop/Turn/Tail Lights

Tough Guy L.E.D. Oval Tail Light



- Sealed LED Oval Tail Light with grommet and plug.
- Easy to install.
- Clam pack for display.

Order No.	Description	List Price	
7-59362	LED Oval Tail Light	\$19.59	GO-3131000
1-59309	Grommet Only	\$3.89	HO-3320000

Tough Guy L.E.D. 6" Clear Oval Tail Light



- Clear lens, white LED back-up light.
- 10 White LED's.
- Includes: Grommet and wire plug.

Order No.	Description	List Price	
7-59419	LED Oval Tail Light	\$22.99	GO-0451000
1-59309	Grommet Only	\$3.89	HO-3320000

- Electronics
- Trolling Motors
- Instruments
- Electrical
- Lighting
- Anchor & Dock
- Safety
- Steering, Controls
- Pumps
- Fuel System
- Seating & Pedestals
- Trailer
- Tops & Covers
- Perform.
- Propellers
- Engine & Care
- Cleaning & Care
- Paint & Paint Acc.
- Fun & Flotation
- Topside Acc.
- Cockpit & Deck
- Hardware, Fasteners
- Camouflage
- Misc.
- Comm.

Stop/Turn/Tail Lights

Tough Guy 6" Clear Oval Tail Light



- 6" clear back up lens.
- Incandescent white light bulb.

Order No.	Description	List Price	
7-59314	Clear Oval Tail Light	\$5.79	GO-8830000

Tough Guy 6" Sealed Oval Tail Light



- Easy to install.
- Includes: Grommet and wire plug.
- Clam pack.

Order No.	Description	List Price	
7-59307	Oval Tail Light with Grommet and Plug	\$8.39	GO-2650000
7-59308	Oval Tail Light Module Only	\$5.99	GO-1040000
1-59309	Grommet Only	\$3.89	HO-3320000

Optronics 6" Oval Sealed Stop/Turn/Tail Light



- Sonically sealed, waterproof.
- Comes with A70GB grommet and A45PB pigtail - 3-wire (PL-3) in a clam pack.

Order No.	Mfg. No. / Description	List Price	
522993	(ST-70RK) Stop/Turn/Tail Light	\$13.69	HO-1280000
523008	(ST-70RS) Module Only	\$9.29	HO-7550000

L.E.D. Clearance Lights

Tough Guy L.E.D. Marker Clearance Lights



- LED Advantage trailer lights are brighter than standard conventional bulbs but use 90% less energy.
- LED Advantage trailer lights are 100% maintenance free.
- Limited LED Lifetime Warranty: if the LED fails, we'll replace it.
- Meets the requirements of SAE/DOT/FMVSS/CMVSS standards when properly installed.
- Simple install-run the black wire to power, the base is self grounding.

Order No.	Description	List Price	
7-0070	Amber	\$4.89	GO-8230000
7-0071	Red	\$4.89	GO-8230000

Tough Guy L.E.D. Sleek Accent Lights



- Sleek design for an updated look.
- Vibrant illumination.
- Low amp draw.
- Features a chrome bezel.

Order No.	Description	List Price	
7-59365	Amber	\$6.49	GO-5340000
7-59366	Red	\$7.19	GO-2840000

Optronics L.E.D. Sealed Marker/Clearance Lights - Stud Mount



- Sonically sealed, waterproof.
- Stainless steel base.

Order No.	Mfg. No. / Description	List Price	
522892	(MCL-95AS) Amber	\$12.59	HO-5570000
522894	(MCL-95RS) Red	\$11.69	HO-1070000

Tough Guy L.E.D. Trailer Clearance Markers



- 1 wire stud mount.
- Stud acts as ground.

Order No.	Description	List Price	
7-59274	Amber	\$6.69	GO-8440000
7-59275	Red	\$6.69	GO-8440000

Optronics Mini Thinline L.E.D. Sealed Marker/Clearance Lights



- Sonically sealed, waterproof.
- Includes: 1-wire plug and chrome base.

Order No.	Mfg. No. / Description	List Price	
522882	(MCL-91AK) Amber	\$12.09	HO-5270000
522884	(MCL-91RK) Red	\$13.09	HO-5870000



L.E.D. Clearance Lights

Tough Guy L.E.D. Submersible Clearance Lights - Stud Mount

- 1 wire stud mount.
- Stud acts as ground.
- Clam pack.

Order No.	Description	List Price	
7-59312	Amber	\$7.09	GO-5740000
7-59313	Red	\$5.89	GO-5930000



Tough Guy L.E.D. Submersible Clearance Lights - Ear Mount



- 100% Waterproof!
- Stainless steel hardware.
- Clam pack.

Order No.	Description	List Price	
7-59310	Amber	\$5.29	GO-4530000
7-59311	Red	\$5.09	GO-1430000

Tough Guy L.E.D. Round Recessed Trailer Light



- 4" Round recessed trailer light.
- Bright and easy to mount.

Order No.	Description	List Price	
7-59361	Red	\$17.39	GO-5611000

Tough Guy L.E.D. Mini Trailer Clearance Lights



- Includes: 3/4" black grommet and chrome bezel.
- 2 wire.

Order No.	Description	List Price	
7-59278	Amber	\$4.49	GO-1030000
7-59279	Red	\$4.49	GO-1030000

Standard Clearance Lights

Tough Guy Trailer Clearance Marker Lights

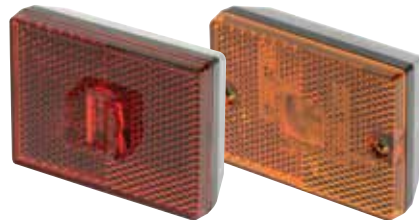

- Incandescent bulb.
- Stud mount.

Order No.	Description	List Price	
7-59217	Amber	\$3.29	GO-0220000
7-59218	Red	\$3.29	GO-0220000

Tough Guy Snap-In Bezel Trailer Clearance Marker Lights



- Choose chrome or black snap-in bezel.
- Incandescent bulb.

Order No.	Description	List Price	
7-59270	Marker Light	Amber	\$4.59 GO-8030000
7-59271	Marker Light	Red	\$4.59 GO-8030000
7-59272	Light Module Only	Amber	\$4.09 GO-4720000
7-59273	Light Module Only	Red	\$4.09 GO-4720000

Electronics

Trolling Motors

Instruments

Electrical

Lighting

Anchor & Dock

Safety

Steering, Controls

Pumps

Fuel System

Seating & Pedestals

Trailer

Tops & Covers

Perform.

Propellers

Engine & Care

Cleaning & Care

Paint & Paint Acc.

Fun & Flotation

Topside Acc.

Cockpit & Deck

Hardware, Fasteners

Camouflage

Misc.

Comm.

Standard Clearance Lights

Tough Guy Mini Trailer Side Marker Lights



- Incandescent bulb.
- Stud mount.
- Stainless steel base.

Order No.	Description	List Price
7-59247	Amber	\$3.59
7-59248	Red	\$3.59

Optronics Sealed Marker/Clearance Lights



522880



684856



684832



684820

- Sonically sealed, waterproof.
- Kits include: Black base - self-grounding and 1-wire plug - 12" lead in a clam pack.

Order No.	Mfg. No. / Description	List Price
684856	(MC-92RS) Red Kit with Black Base	\$5.49
522880	(MC-91RS) Red Kit with Chrome Base	\$5.09

MODULES ONLY

Order No.	Mfg. No. / Description	List Price
684832	(MC-90AS) Amber Module Only	\$3.59
684820	(MC-90RS) Red Module Only	\$3.59

Tough Guy Reflectors

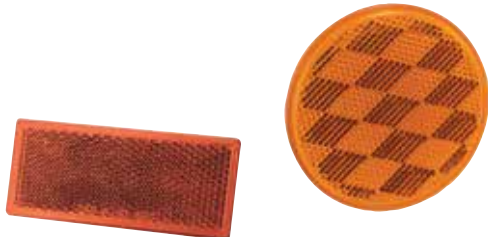

- DOT approved stick-on reflectors.

Order No.	Description	List Price
7-59320	Amber Dimensions: 1-1/2" x 3"	\$2.09
7-59323	Red Dimensions: 1-1/2" x 3"	\$2.09
1-59321	Amber Dimensions: 3" Round	\$3.49
1-59322	Red Dimensions: 3" Round	\$3.49

Optronics Sealed Marker/Clearance Lights



- Sonically sealed, waterproof.
- Stud-mount. Stainless steel base.
- Single wire design grounds through mounting hardware.

Order No.	Mfg. No. / Description	List Price
522889	(MC-95AS) Amber	\$5.29
522888	(MC-95RS) Red	\$5.69

Wesbar Replacement Len for Side Marker/Clearance Light



- Replacement lens for side marker/clearance light.

Order No.	Mfg. No. / Description	List Price
6830025	(3337) Red Lens	\$2.39

Wesbar Replacement Rectangular Grommet



- Replacement rectangular grommet.

Order No.	Mfg. No. / Description	List Price
6830015	(221588)	\$2.89

Tough Guy Reflective Safety Tape



- (2) 2" x 12" strips.
- Dot-C2 Approved.

Order No.	Description	List Price
7-59325	Reflective Safety Tape	\$4.09

Tough Guy L.E.D. Light Bar



- Submersible 3 LED identification light bar for over 80" trailers.
- Durable, corrosion proof base.
- Dimensions: 17" x 1.75" x 1.5".
- 12 volt.

Order No. Description List Price
7-59352 LED Light Bar **\$17.59** GO-9711000

Optronics L.E.D. Sealed ID Light Bar for Over 80" Applications



- Designed for trailers over 80" wide.
- Sealed, waterproof lights on stainless steel base.
- Single wire, grounds through mounting hardware.

Order No. Mfg. No. / Description List Price
522886 (MCL-97RK) **\$36.19** HO-1712000

Optronics Sealed ID Light Bar

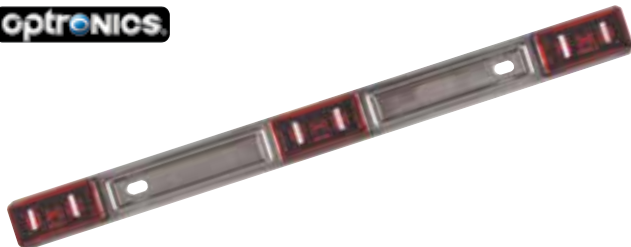

- Stainless steel base.
- Surface mount on 8-1/2" centers.
- Sealed, waterproof lights.
- Single wire, self grounding.

Order No. Mfg. No. / Description List Price
522890 (MC-97RK) **\$19.29** HO-7511000

T-H Marine BlueWaterLED Trailer Reverse Strip L.E.D. Lighting

- Provides plenty of light for seeing that dark ramp behind you or those expensive items in your driveway that are hard to see when finally getting home from a fishing trip.
- Includes: (2) 30 LED/20" Blue Water LED Light Strips with 3M Industrial Waterproof Adhesive Backing (White LEDs), T-tap connectors and male connectors.
- Note: With an existing reverse circuit, simply connect the Red (+) wire into your reverse wiring and ground the Black (-) wire. For trailers with no reverse circuit, it is necessary to run a wire from your trailer plug to the rear of your trailer.
- Lifetime limited warranty.

Order No. Mfg. No. / Description List Price
587478 (LEDBW112WDP) **\$65.19** EO-9884000

Tough Guy L.E.D. Trailer Identification Bar



- 3 LED's.
- Stainless steel base.

Order No. Description List Price
7-59260 Red **\$15.49** GO-8301000

Tough Guy Trailer Identification Bar



- Corrosion free polymer base.
- 3-light, incandescent bulbs.

Order No. Description List Price
7-59249 Red **\$11.19** GO-0570000

Tough Guy Trailer Identification Bar



- Stainless steel base.
- 3-light, incandescent bulbs.

Order No. Description List Price
7-59261 Red **\$11.29** GO-6570000



- Electronics
- Trolling Motors
- Instruments
- Electrical
- Lighting
- Anchor & Dock
- Safety
- Steering, Controls
- Pumps
- Fuel System
- Seating & Pedestals
- Trailering**
- Tops & Covers
- Perform.
- Propellers
- Engine & Care
- Cleaning & Care
- Paint & Paint Acc.
- Fun & Flotation
- Topside Acc.
- Cockpit & Deck
- Hardware, Fasteners
- Camouflage
- Misc.
- Comm.

- Electronics
- Trolling Motors
- Instruments
- Electrical
- Lighting
- Anchor & Dock
- Safety
- Steering, Controls
- Pumps
- Fuel System
- Seating & Pedestals
- Trailer**
- Tops & Covers
- Perform.
- Propellers
- Engine & Care
- Cleaning & Care
- Paint & Paint Acc.
- Fun & Flotation
- Topside Acc.
- Cockpit & Deck
- Hardware, Fasteners
- Camouflage
- Misc.
- Comm.

Tough Guy License Plate Mounting Bracket



- Universal slotted mount.
- Quick and easy installation.
- Rust and corrosion proof.

Order No.	Description	List Price
7-59098	License Plate Mounting Bracket	\$1.39

Optronics Rust Proof License Plate Bracket



- Angled license plate bracket, made of rust proof black polymer.
- Accept stud mount license plate lights.

Order No.	Mfg. No. / Description	List Price
685098	(LP-10S)	\$4.29

Tie Down License Plate Mounting Bracket



- License plate bracket is made of heavy duty aluminum treadbrite material.
- Multiple hole placement provides universal mounting options.

Order No.	Mfg. No. / Description	List Price
578376	(86565)	\$9.39

Optronics Medium Strength Frame Clips



- Sold 10 pieces per pack.
- Frame clips can be used to hide or keep wires and wire harness in place and away from potential damage.

Order No.	Mfg. No. / Description	List Price
223975	(A-12FC)	\$2.39

Tie Down Tail Light Protector - Aluminum Tread Brite



Tough Guy Polyethylene License Plate Bracket



- Standard license plate bracket.
- 2" hole centers.

Order No.	Description	List Price
7-59102	License Plate Bracket	\$1.69

Tough Guy Galvanized License Plate Bracket



- Standard license plate bracket.
- 2" hole centers.

Order No.	Description	List Price
7-59101	License Plate Bracket	\$7.59

Tough Guy Trailer Wire Frame Clips



- Secures and organizes trailer wire along the trailer frame.
- Zinc plated.
- Corrosion resistant.

Order No.	Description	List Price
7-59289	Trailer Wire Frame Clips	\$2.09

Tie Down Universal Tail Light Bracket



- The universal tail light bracket is made from heavy duty 7 gauge steel and is hot dip galvanized for long lasting protection.

Order No.	Mfg. No. / Description	List Price
578378	(86566)	\$5.29

7-Way RV Blade Connector Wiring Diagram

7-Way Wiring Index

Wire Color & Gauge	Molded Trailer/Sealed Car Connector Terminal	Thermo-Plastic/Metal Connector Terminal
Blue / 12 gauge	Electric Brake	#2 Electric Brake
Black / 10 gauge	Battery Charge	#4 Battery Charge
Brown / 14 gauge	Right Stop & Turn	#6 Right Stop & Turn

7-WAY MOLDED TRAILER/SEALED CAR CONNECTOR & CABLE

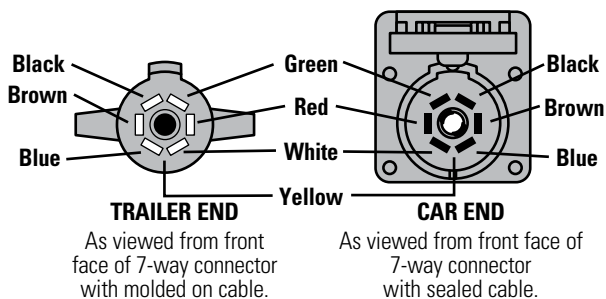

7-WAY THERMO-PLASTIC/METAL CONNECTOR

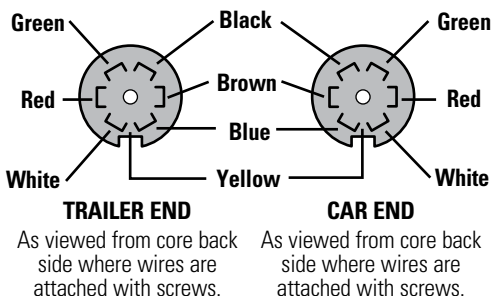

7-Way Molded Trailer Connectors

Pin Clocking

RV - GAUGE 2/10, 1/12, 4/14

- Wire Color, Gauge & Function
- White / 10 gauge / Common Ground
 - Blue / 12 gauge / Electric Brake
 - Green / 14 gauge / Tail & License
 - Black / 10 gauge / Battery Charge
 - Red / 14 gauge / Left Stop & Turn
 - Brown / 14 gauge / Right Stop & Turn
 - Yellow / 14 gauge / Center Auxiliary

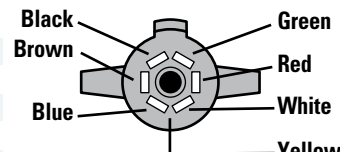

TRAILER END

As viewed from front face of 7-way connector with molded on cable.

HEAVY DUTY TRAILER - GAUGE 2/10, 1/12, 4/14

- Wire Color & Gauge
- White / 10 gauge
 - Blue / 12 gauge
 - Green / 14 gauge
 - Black / 10 gauge
 - Red / 14 gauge
 - Brown / 14 gauge
 - Yellow / 14 gauge

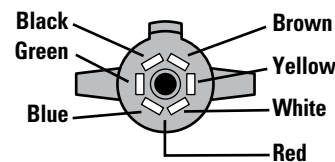

TRAILER END

As viewed from front face of 7-way connector with molded on cable.

COLD WEATHER - GAUGE 3/10, 4/14

- Wire Color & Gauge
- White / 10 gauge
 - Blue / 14 gauge
 - Green / 14 gauge
 - Black / 10 gauge
 - Red / 10 gauge
 - Brown / 14 gauge
 - Yellow / 14 gauge

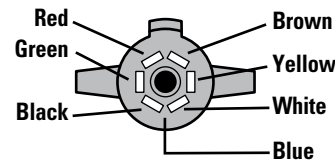

TRAILER END

As viewed from front face of 7-way connector with molded on cable.

NOTE: 7-Way Heavy Duty and Cold Weather trailer wiring diagrams represent wire location and color but are NOT supplied to represent any wire or color functions. Please contact your trailer manufacturer for further details.

6-Way Round Pin Connector Wiring Diagram

6-WAY MOLDED TRAILER/SEALED CAR CONNECTOR & CABLE

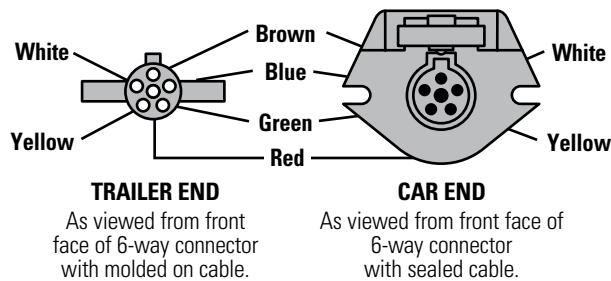

6-WAY ZINC DIE-CAST CONNECTOR

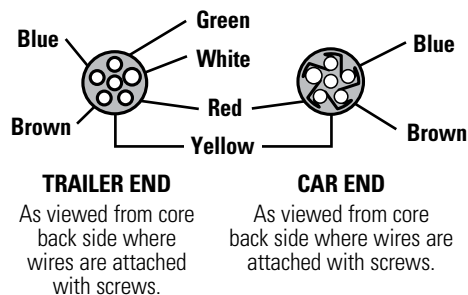

6-Way Wiring Index

Wire Color & Gauge	Molded Trailer/Sealed Car Connector Terminal	Zinc Die-Cast Connector Terminal
White / 10/14 gauge	Common Ground	GD - Common Ground
Blue / 10/14 gauge	Electric Brake	S - Electric Brake
Green / 14 gauge	Right Stop & Turn	TM - Tail & License
Red / 10/14 gauge	Auxiliary	LT - Left Stop & Turn
Brown / 14 gauge	Tail & License	RT - Right Stop & Turn
Yellow / 14 gauge	Left Stop & Turn	A - Auxiliary

Technical information is current as of the printing of this catalog. Contact technical service for periodic updates.

- Electronics
- Trolling Motors
- Instruments
- Electrical
- Lighting
- Anchor & Dock
- Safety
- Steering, Controls
- Pumps
- Fuel System
- Seating & Pedestals
- Trailering
- Tops & Covers
- Perform.
- Propellers
- Engine & Care
- Cleaning & Care
- Paint & Paint Acc.
- Fun & Flotation
- Topside Acc.
- Cockpit & Deck
- Hardware, Fasteners
- Camouflage
- Misc.
- Comm.

4-Way Round Pin / Flat Connector Wiring Diagram

4-WAY ROUND PIN CONNECTOR

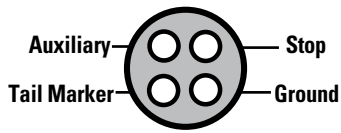

TRAILER END

As viewed from core back side where wires are attached with screws.

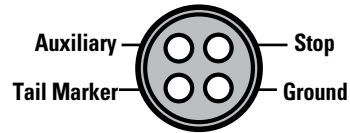

CAR END

As viewed from core back side where wires are attached with screws.

4-WAY FLAT PIN CONNECTOR

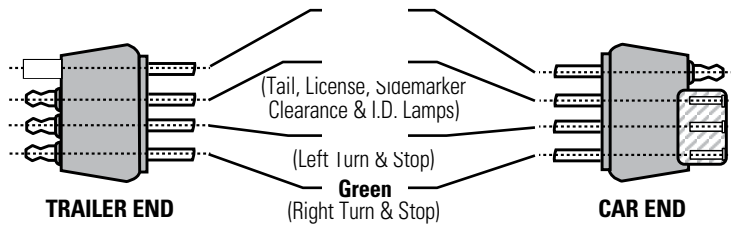

TRAILER END

CAR END

5-Way Flat Connector Wiring Diagram

5-WAY FLAT PIN CONNECTOR

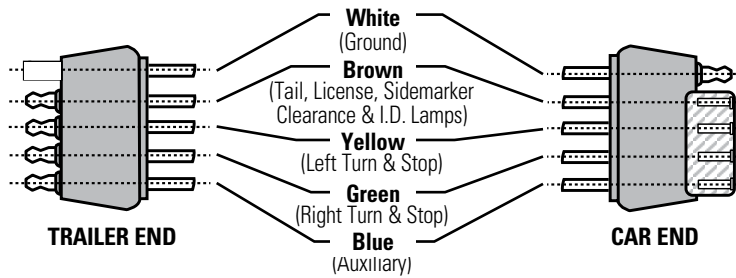

TRAILER END

CAR END

Technical information is current as of the printing of this catalog. Contact technical service for periodic updates.

- Electronics
- Trolling Motors
- Instruments
- Electrical
- Lighting
- Anchor & Dock
- Safety
- Steering, Controls
- Pumps
- Fuel System
- Seating & Pedestals
- Trailer
- Tops & Covers
- Perform.
- Propellers
- Engine & Care
- Cleaning & Care
- Paint & Paint Acc.
- Fun & Flotation
- Topside Acc.
- Cockpit & Deck
- Hardware, Fasteners
- Camouflage
- Misc.
- Comm.

Tough Guy 7-Round to 5-Flat Trailer Adapters



- These one piece adapters go from a 7-round blade socket (vehicle) to a 5-flat plug (trailer).

Order No.	Description	List Price
7-0507	7-Round to 5-Flat Adapter	\$8.59 G0-6750000
7-0527	Length 16"	\$11.79 G0-0970000

Tough Guy 7-Round to 4-Flat Trailer Adapter



- Adapts a 7-round blade socket (vehicle) to a 4-flat plug (trailer).

Order No.	Description	List Price
7-0506	7-Round to 4-Flat Trailer Adapter	\$7.39 G0-5940000

Tough Guy 4-Pole Trailer Test Plug with Cap



- LED's glow to show working circuits.
- Checks brake, tail and turn lights.

Order No.	Description	List Price
7-0503	4-Pole Trailer Test Plug	\$4.99 G0-4330000

Tough Guy 4-Way Flat Trailer/Car Wiring Harnesses

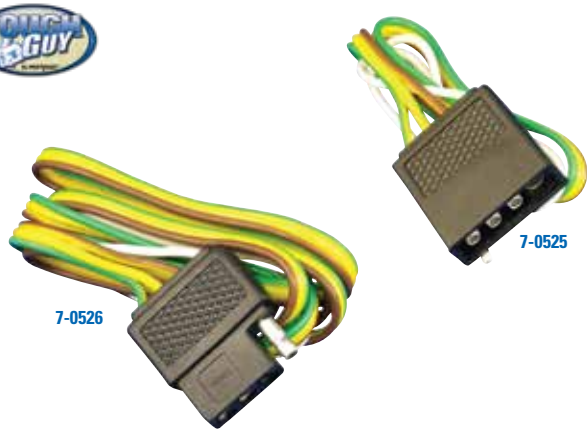

- Color-coded wire indexed connector molded to the wire, eliminating possibility of corrosion and shorting due to moisture.

Order No.	Description	List Price
7-0525	Male Plug with 1' Wire Trailer Side	\$3.49 G0-4320000
7-0526	Female Plug with 4' Wire Vehicle Side	\$5.19 G0-8430000

Tough Guy Trailer Wire Adapter with Short Lead



- 7-round to 5-flat trailer wire adapter provides a secure connection between your trailer and tow vehicle.
- Black plastic construction.

Order No.	Description	List Price
7-59396	Short Lead	\$12.39 G0-0380000

Tough Guy Coiled Trailer Adapter



- Retractable coiled design for 7-Way RV Blade (from vehicle) to 5-Way Flat (to vehicle).
- Weatherproof cable design.
- Corrosion resistant.

Order No.	Description	List Price
7-59263	7-Round to 5-Flat Adapter	\$43.69 G0-7292000

Wesbar 4-Way Wiring Harness Connectors

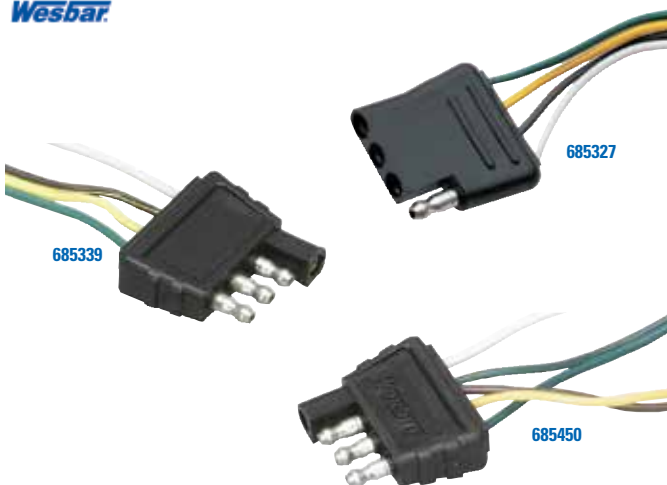

- Flat, 4-way trailer connectors.
- All connectors have an 18" ground wire.
- Conforms to all applicable SAE, NMMA and TMA standards.

Order No.	Mfg. No. / Description	List Price
685327	(707275) 4' Trunk Connector	\$7.59 H0-5540000
685339	(707285) 18" Trailer Connector, Wunside Style	\$6.09 H0-5630000
685450	(707286) 18" Trailer Connector, Wishbone Style	\$7.89 H0-3740000

- Electronics
- Trolling Motors
- Instruments
- Electrical
- Lighting
- Anchor & Dock
- Safety
- Steering, Controls
- Pumps
- Fuel System
- Seating & Pedestals
- Trailer**
- Tops & Covers
- Perform.
- Propellers
- Engine & Care
- Cleaning & Care
- Paint & Paint Acc.
- Fun & Flotation
- Topside Acc.
- Cockpit & Deck
- Hardware, Fasteners
- Camouflage
- Misc.
- Comm.

Tough Guy 5-Way Flat Trailer/Car Wiring Harnesses

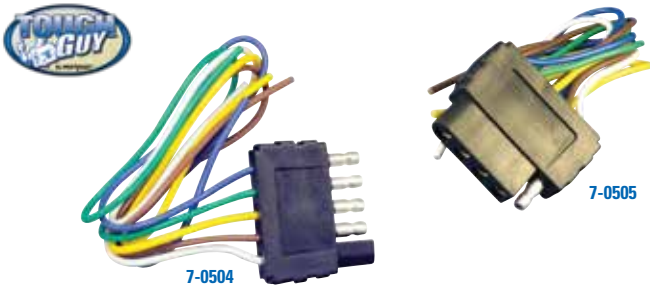

- Color coded lead wires.
- 12 and 24 volt capacity.

Order No.	Description	Trailer Side	Vehicle Side	List Price
7-0504	Male Plug with 1' Wire			\$4.39
7-0505	Female Plug with 4' Wire			\$6.09

Tough Guy Trailer Extension Harnesses

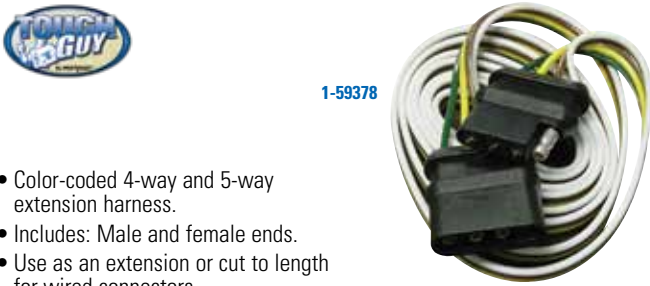

- Color-coded 4-way and 5-way extension harness.
- Includes: Male and female ends.
- Use as an extension or cut to length for wired connectors.

Order No.	Description	List Price
7-59379	4-Way, 1' Long	\$4.49
7-59380	4-Way, 2' Long	\$5.69
1-59378	4-Way, 5' Long	\$10.09
7-59385	5-Way, 1' Long	\$5.29
7-59386	5-Way, 2' Long	\$5.79

Tough Guy 4-Way Trailer Wiring Kit



- Designed for the do-it-yourselfer, these trailer wiring kits are easy to install.
- The kit comes complete with wishbone wiring harness, wire connectors and clips.
- Color-coded 4-way wires.

Order No.	Description	List Price
7-59372	25' Wire Harness	\$16.59

Optronics 4-Way "Wishbone" Trailer Wiring Kit



- 25' wishbone 4-way trailer wiring harness.

Order No.	Mfg. No. / Description	List Price
685529	(A-25WH) Length 25'	\$24.29

Wesbar 5-Way Wiring Harness Connector



- Flat, 5-way trailer connector.
- Connector includes 4' ground and 4' auxiliary.
- Wishbone style.
- Conforms to all applicable SAE, NMMA and TMA standards.

Order No.	Mfg. No. / Description	List Price
685342	(707283) 4' Trailer Connector	\$13.79

Wesbar Trailer Extension Harnesses

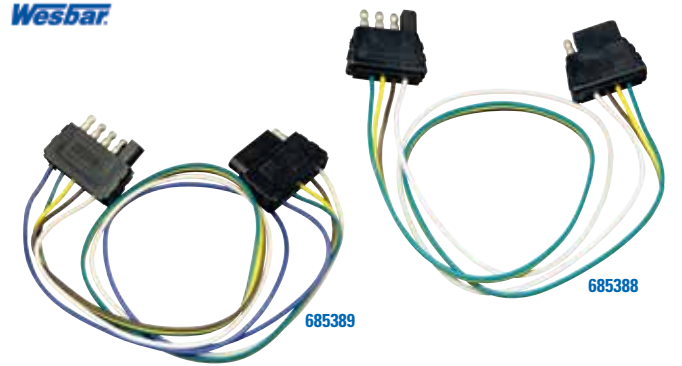

Order No.	Mfg. No. / Description	List Price
685388	(707254) 4-Way, Length 2'	\$10.39
685389	(707255) 5-Way, Length 2'	\$12.79

Tough Guy 5-Way Trailer Wiring Kit



- 5-way trailer wiring kit.
- 40' wishbone trailer harness.
- Includes: Vehicle & trailer connectors, (8) trailer clips and (2) wire connectors.

Order No.	Description	List Price
7-59437	40' Wire Harness	\$29.19

Optronics 5-Way "Wishbone" Trailer Wiring Kit



- 25' wishbone 5-way trailer wiring harness 30" ground, 5' blue wire.

Order No.	Mfg. No. / Description	List Price
523295	(A-255WH) Length 25'	\$21.99

- Electronics
- Trolling Motors
- Instruments
- Electrical
- Lighting
- Anchor & Dock
- Safety
- Steering, Controls
- Pumps
- Fuel System
- Seating & Pedestals
- Trailing
- Tops & Covers
- Perform.
- Propellers
- Engine & Care
- Cleaning & Care
- Paint & Paint Acc.
- Fun & Flotation
- Topside Acc.
- Cockpit & Deck
- Hardware, Fasteners
- Camouflage
- Misc.
- Comm.

Tough Guy Trailer Winches



- Corrosion resistant zinc coating.
- Two-way ratchet with neutral.
- Winch strap with hook included.
- Smooth turning grip.

Order No.	Size	Gear Ratio	Strap Length	List Price	
7-1597	600 lbs.	3 to 1	12'	\$42.39	GO-0482000
7-1589	1,000 lbs.	4 to 1	12'	\$48.79	GO-9623000
7-1591	1,400 lbs.	4 to 1	12'	\$51.39	GO-3443000
7-1592	1,800 lbs.	5 to 1	2" x 15'	\$66.19	GO-5344000

Tough Guy Dual Gear Trailer Winch



- 2,000 lbs maximum capacity.
- 4 to 1 gear ratio.
- Dual drive gears for uniform torque with better stability and more power.
- Two-way ratchet with neutral.
- Corrosion resistant zinc coating.
- 2" x 20' winch strap with hook included.
- Smooth turning grip.

Order No.	Description	List Price	
7-1594	Dual Gear Trailer Winch	\$64.59	GO-8234000

Tough Guy 2-Speed Trailer Winch with Brake

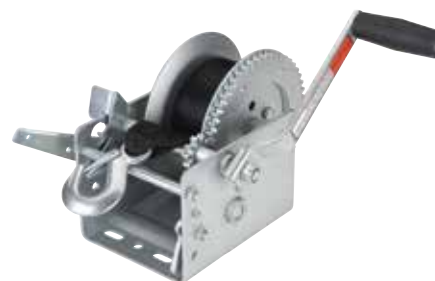

- 2,500 lbs maximum capacity.
- Dual speeds with 5 to 1 & 12 to 1 gear ratio.
- Heavy duty construction.
- Two-way ratchet with neutral.
- Hand brake included for safety.
- Corrosion resistant coating.
- 2-1/2" x 20' winch strap with hook included.
- Smooth turning grip.

Order No.	Description	List Price	
7-1596	Dual Speed Trailer Winch with Brake	\$117.89	GO-9987000

Fulton Single Speed Trailer Winches



- Fulton winches feature efficient gear ratios, full-length drum bearings, oil-impregnated shaft bushings and a "Comfort Grip" handle for ease of cranking.
- All gears are high-carbon steel for superb strength and long-term durability.
- Stamped carbon steel frames provide rigidity for gear alignment and longer cycle life.
- Zinc finishes provide excellent corrosion resistance in all environments.
- Designed for use with rope or strap.

Order No.	Mfg. No. / Description	List Price	
685600	(142001) 900 lbs.	\$56.09	F0-6293000
685605	(142100) 1,100 lbs.	\$62.29	F0-0634000
685610	(142311) 1,400 lbs. w/20' Strap & Black Cover	\$138.69	F0-8079000
685616	(142203) 1,500 lbs. with 20' Strap	\$84.99	F0-9495000
685623	(142300) 1,800 lbs.	\$104.39	F0-7037000

Tough Guy Comfort Grip Winch Handle



- Zinc plating offers maximum corrosion resistance.
- Ergonomic comfort grip included.
- Universal design fits most winches.

Order No.	Description	List Price	
7-1600	Winch Handle	\$14.69	GO-4890000

- Electronics
- Trolling Motors
- Instruments
- Electrical
- Lighting
- Anchor & Dock
- Safety
- Steering, Controls
- Pumps
- Fuel System
- Seating & Pedestals
- Trailer
- Tops & Covers
- Perform.
- Propellers
- Engine & Care
- Cleaning & Care
- Paint & Paint Acc.
- Fun & Flotation
- Topside Acc.
- Cockpit & Deck
- Hardware, Fasteners
- Camouflage
- Misc.
- Comm.

Tough Guy Trailer Winch Cables



- Galvanized steel 7 x 19 aircraft cable is made to handle the heavy loads.
- Each cable is fitted with a heavy duty galvanized latch hook, pull proof loop and a fastener end for replacement use on electric winches.
- Also great for hand crank winches.

Order No.	Description	List Price	
7-1845	3/16" x 25' Cable	\$19.49	GO-6031000
7-1846	7/32" x 25' Cable	\$21.29	GO-6241000
7-1847	7/32" x 50' Cable	\$41.19	HO-1742000

Tough Guy Winch Strap with Loop End



- Heavy duty webbing.
- Breaking strength: 10,000 lbs.
- Forged steel hook.
- Includes hardware for installation.
- 2" x 25' strap.

Order No.	Description	List Price	
7-2113	Winch Strap with Loop End	\$32.89	GO-4022000

Tough Guy Winch Straps with Loop End



- Heavy duty webbing.
- Breaking strength: 6,000 lbs.
- Loads up to 2,000 lbs.
- Forged steel hook.
- Includes hardware for installation.

Order No.	Description	List Price	
7-2110	2" x 20' Strap	\$11.99	GO-3080000
7-2111	2" x 30' Strap	\$15.29	GO-4201000

Tough Guy Winch Strap with Safety Strap



- Includes a 24" Safety Strap securing your boat to the trailer in the event the winch strap fails.
- Each strap is equipped with two heavy duty utility hooks.
- Replaces: OEM 9642019.

Order No.	Description	List Price	
7-59822	2" x 20' Strap	\$20.19	GO-3531000

Tough Guy PWC Winch Strap



- PWC winch strap made of high impact polyester webbing.
- Heavy duty hook.
- Breaking strength 4,500 lbs.
- 12' long with 1" x 18" loop.

Order No.	Description	List Price	
7-59815	2" x 12' Strap	\$17.59	HO-5501000

Tough Guy Winch Strap and Hook



- High impact polyester strap.
- Fits standard trailer winches.
- Heavy duty utility hook.

Order No.	Description	List Price	
7-59816	2" x 15' Strap	\$17.59	HO-5501000

Rod Saver Replacement Winch Strap with Tail



- 20' replacement winch strap constructed of 7,000 lb. polyester belt and 6,600 lb. drop forged snap hook.
- Has a sewn tail for drum installation.

Order No.	Mfg. No. / Description	List Price	
2003855	(WS20T)	\$14.29	F0-0001000

Rod Saver Winch Strap with Safety Strap



- 20' replacement winch strap with 30" safety strap and 3,970 lb. drop forged snap hook.
- The winch strap is constructed of 7,000 lb. polyester belt and 6,600 lb. drop forged snap hook.
- Includes a bolt and nylon lock nut for drum installation.

Order No.	Mfg. No. / Description	List Price	
2003857	(WS20S)	\$18.79	F0-5131000

- Electronics
- Trolling Motors
- Instruments
- Electrical
- Lighting
- Anchor & Dock
- Safety
- Steering, Controls
- Pumps
- Fuel System
- Seating & Pedestals
- Trailer
- Tops & Covers
- Perform.
- Propellers
- Engine & Care
- Cleaning & Care
- Paint & Paint Acc.
- Fun & Flotation
- Topside Acc.
- Cockpit & Deck
- Hardware, Fasteners
- Camouflage
- Misc.
- Comm.

Rod Saver Heavy Duty Yellow Winch Strap



- A 2" x 25' wide yellow heavy duty replacement winch strap constructed with 10,000 lb. webbing and a 10,000 lb. drop forged snap hook.

Order No. Mfg. No. / Description List Price
2003860 (WSY25) **\$29.09** F0-6302000

Marpac Bow Safety Chain



- Includes: S-hook on one end.

Order No. Description List Price
7-1852 3/16" x 12 Links **\$10.29** G0-9860000

T-H Marine Z-LAUNCH™ Watercraft Launch Cord



- The patented Z-LAUNCH Watercraft Launch Cord makes solo watercraft launching easier than you've ever experienced.
- The no-hassle launch cord, made of premium elastics, uses automatically adjusting tension when you back your boat, jet ski, or tow tube into the water, so it won't jerk your watercraft around when you pull the trailer forward.
- Fasten a hook to your trailer, connect a steel ring to the winch, and lock the winch.
- You're ready for the smoothest watercraft launching on the water.

Order No. Mfg. No. / Description List Price
6430025 (ZL-20-DP) Length 20' For Boats 23' to 35' **\$58.69** H0-1253000

Marpac Snap Trailer Hook



- Malleable iron.
- 2,300 lbs. breaking strength.
- Length overall 3-1/2".

Order No. Description List Price
7-0288 Eye 2" **\$4.19** G0-1820000

Master Lock Portable 12 volt Electric Winch

- Portable 12 volt DC electric winch.
- 2,000 lb. pulling capacity.
- Galvanized steel cable with safety hook.
- Includes: Steel mounting plate, 20 ft. power cable, remote control and hand crank.
- Limited One (1) Year Warranty.

Order No. Mfg. No. / Description List Price
2001284 (2953) **\$151.09** G0-3210100



Superwinch EX1 Electric Winch



- 5/32" x 25' wire rope.
- Power in and power out.
- Battery cables with terminals.
- Line speed 12' per minute at maximum working load of 1,000 lbs.
- Includes: A wire rope tensioner and a handsaver strap.
- A rugged gearbox and simple direct motor-mounted switching mechanism.
- A 1.3 hp motor, differential planetary gearing and a dynamic breaking action.

Order No. Mfg. No. / Description List Price
638607 (1110) 12 volt **\$409.29** F0-0568200

Superwinch X1 Electric Winch



- 3/16" x 25' wire rope.
- Power in and power out.
- Battery cables with terminals.
- Line speed 7' per minute at maximum working load of 2,000 lbs.
- Includes: A wire rope tensioner and a handsaver strap.
- A rugged gearbox and simple direct motor-mounted switching mechanism.
- A 1.8 hp motor, differential planetary gearing and a dynamic breaking action.

Order No. Mfg. No. / Description List Price
638633 (1101) 12 volt **\$504.29** F0-0035300

- Electronics
- Trolling Motors
- Instruments
- Electrical
- Lighting
- Anchor & Dock
- Safety
- Steering, Controls
- Pumps
- Fuel System
- Seating & Pedestals
- Trailering
- Tops & Covers
- Perform.
- Propellers
- Engine & Care
- Cleaning & Care
- Paint & Paint Acc.
- Fun & Flotation
- Topside Acc.
- Cockpit & Deck
- Hardware, Fasteners
- Camouflage
- Misc.
- Comm.

Boater Sports L.E.D. Indicator Guide Lights



- Attaches to trailer or guide-on posts for loading and unloading.
- Springs help prevent breakage.
- 24" Long.

Order No. Mfg. No. / Description
1-59350 (59350)

List Price
\$38.79 HO-7232000

Tie Down Pontoon "Floating" Guide On's



- Designed for submerged trailers, the PVC guide automatically rises upward adding an additional 12" in visibility, for a total adjustable viewing height of 24" - 36".
- Bright orange end caps on these PVC posts provide a clear target when loading your pontoon boat.
- Made of 1-1/2" square, 16-gauge steel galvanized tubing and covered by 2" x 20" PVC pipe.
- Guide posts extend fully into the PVC tube for additional strength.
- Mounts to trailer cross members 2" wide by 2", 3" or 4" high.
- All mounting hardware included.

Order No. Mfg. No. / Description
578325 (86468) Sold in Pairs

List Price
\$101.39 FO-7907000

Electronics

Trolling Motors

Instruments

Electrical

Lighting

Anchor & Dock

Safety

Steering, Controls

Pumps

Fuel System

Seating & Pedestals

Trailer

Tops & Covers

Perform.

Propellers

Engine & Care

Cleaning & Care

Paint & Paint Acc.

Fun & Flotation

Topside Acc.

Cockpit & Deck

Hardware, Fasteners

Camouflage

Misc.

Comm.

Tie Down PVC Post "Heavy Duty" Guide On's



- Feature bright orange end caps providing visual markers to help launch and load your boat safely.
- Post length 48".
- The 13° slant guide posts give a wider target when loading your boat.
- Braced inside with metal tubing 15" into the pipe.
- Bolts and nuts are zinc plated and mounting brackets are galvanized for lasting protection against corrosion.
- All mounting hardware included.

Order No. Mfg. No. / Description List Price
578192 (86103) Sold in Pairs **\$72.19** FO-3505000

Tie Down Pontoon Guide On's



- Bright orange end caps on these PVC guides give you a bright, visible target when loading your pontoon boat.
- Designed to be mounted between the pontoons.
- Made of 1-1/2" square, 16-gauge steel tubing and covered with 2" x 20" non-marking white PVC pipe.
- Mounts to trailer cross members 2" wide and 2" - 4" high.
- All mounting hardware included.

Order No. Mfg. No. / Description List Price
578300 (86465) Sold in Pairs **\$78.89** FO-2255000

Tie Down Floating Guide Post

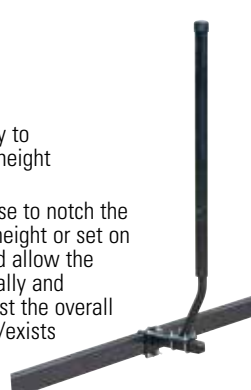

- Features the ability to adjust the overall height from 48" to 60".
- The user can choose to notch the post at a specific height or set on floatable mode and allow the waterline to naturally and automatically adjust the overall height as it enters/exists the water.
- It features a 30° slant through the bottom 18" to allow for varying hull shapes.
- The PVC pipe in non-marring, black in color and designed to hide the floating slot and holes for a clean look.

Order No. Mfg. No. / Description List Price
578190 (86568) Sold in Pairs **\$167.99** HO-9700100

Tie Down High Impact Pontoon Guide On's



- Guide your pontoon boat safely onto the trailer in high winds and strong currents with these high impact guide on's.
- The hot dip galvanized steel 2-1/2" square tube posts are covered with non-marking molded PVC material and designed to be mounted between the pontoons.
- Mounts to trailer cross members 2" wide by 2" - 3" high.
- All mounting hardware included.

Order No. Mfg. No. / Description List Price
578320 (86467) Sold in Pairs **\$109.39** FO-7567000

Tie Down Adjustable PVC Guide On's



- Adapts to most tube and channel trailer frames.
- Galvanized for lasting protection and include heavy duty steel component parts.
- Bright orange end caps on these PVC guides provide a visible target when loading your boat.
- Boat guide on's are 48" high with up to 16" of side adjustment.
- All mounting hardware included.

Order No. Mfg. No. / Description List Price
578290 (86105) Sold in Pairs **\$76.29** FO-0435000

Tie Down Low Rider Guide On's



- Ideal for Jon boats, bass boats and personal watercraft while providing the strength of traditional guide on's.
- The guide posts are made of 1-1/2" square, 16-gauge steel tubing and galvanized for long lasting protection.
- Guide covers are made from high impact non-marking molded PVC.
- Mounts to trailer cross members 2" wide and 2" - 4" high.
- All mounting hardware included.

Order No. Mfg. No. / Description List Price
578310 (86466) Sold in Pairs **\$79.39** FO-7555000

SPECIAL HANDLING MAY APPLY



Tie Down Bunk Board Guide On's



- The 2x4 black carpeted bunk boards are offered in 24" or 60" lengths.
- Posts can be mounted 5" - 11" on the side of the frame.
- If mounted above the frame, bunk placement is 19" high.
- U-bolt & nuts are zinc plated and mounting hardware is galvanized for corrosion protection.
- Kit fits frames 2" and 3" wide up to 4" high.
- Sold in pairs with all mounting hardware included..

Order No.	Mfg. No. / Description	List Price	
578200	(86123) Length 24"	\$111.29	F0-0977000
578206	(86124) Length 60"	\$154.69	F0-8280100

Tie Down Adjustable Roller Side Guide On's



- Roller angle provides up to 16" of adjustment (8" each side) to fit the specific angle of your hull.
- Includes hot dip galvanized steel components with one piece adjustable clamp with U-bolt.
- Fits all channel and tube frames up to 5".

Order No.	Mfg. No. / Description	List Price	
578154	(86106) Sold in Pairs	\$109.29	F0-0567000

Captain's Best Round Aluminum Guide Ons



- 2 each of 1-1/4" schedule 40 aluminum tube and covered with 1-1/2" schedule 160 PVC pipe.
- Overall height 60" with top end caps that are not glued on.
- This allows customer to remove end cap and shorten guides if desired.
- **7-1627** Mounting Kit is sold separately.
- Light Mounting Kit (**7-1628**) is also available.
- Sold per pair.

Order No.	Description	List Price	
7-1625	Aluminum Guide Ons	\$92.59	G0-4026000

Captain's Best Guide On Mounting Kit



- Designed to mount either round or square guides under trailer frame.
- Includes: (4) stainless steel U-bolts 8" long, (8) stainless steel 3/8" lock nuts, (2) aluminum plates with holes spaced for various width trailer frames, (4) 1" x 2" x aluminum channel to fit round guides and (1) instruction sheet.

Order No.	Description	List Price	
7-1627	Mounting Kit	\$77.09	G0-5615000

Tie Down Fixed Angle Roller Guide On's



- Mount these 13" rubber rollers on top or beneath the frame for precise placement.
- The galvanized guide mount adjusts for widths up to 13" on each side and fit frames 2" to 4".
- All mounting hardware included.

Order No.	Mfg. No. / Description	List Price	
5765131	(86102) Sold in Pairs	\$111.99	F0-9387000

Tie Down I-beam Mounting Kit - Guide Posts



- The I-beam mounting kit allows you 1-1/2" square guide tube to securely mount onto any steel or aluminum I-beam trailer frame.
- The kit includes: (4) Brackets, (2) smaller 3/8" bolts and (2) 3/8" bolts depending of frame rail width.
- Brackets are galvanized, hardware in zinc plated.

Order No.	Mfg. No. / Description	List Price	
578374	(86569)	\$20.89	F0-2641000

Captain's Best Square Aluminum Guide Ons



- 2 each of 1-1/2" square tub with 1/8" wall thickness and covered with 2" schedule 160 PVC pipe.
- Overall height is 60" with top end caps that are not glued on.
- This allows customer to remove end cap and shorten guides if desired.
- **7-1627** Mounting Kit is sold separately.
- Light Mounting Kit (**7-1628**) is also available.
- Sold per pair.

Order No.	Description	List Price	
7-1626	Aluminum Guide Ons	\$91.79	G0-0516000

Captain's Best Trailer Light Mounting Kit



Order No.	Description	List Price	
7-1628	Mounting Kit	\$12.19	G0-7180000



SPECIAL HANDLING MAY APPLY



- Electronics
- Trolling Motors
- Instruments
- Electrical
- Lighting
- Anchor & Dock
- Safety
- Steering, Controls
- Pumps
- Fuel System
- Seating & Pedestals
- Trailer
- Tops & Covers
- Perform.
- Propellers
- Engine & Care
- Cleaning & Care
- Paint & Paint Acc.
- Fun & Flotation
- Topside Acc.
- Cockpit & Deck
- Hardware, Fasteners
- Camouflage
- Misc.
- Comm.

Tie Down Bunk Slicks

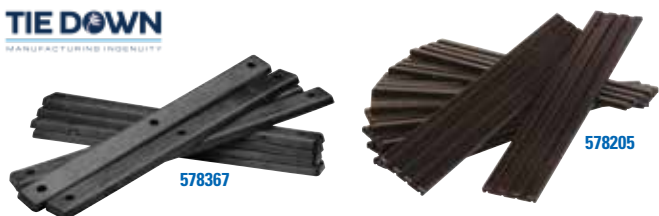

- PVC molded Bunk Slicks bolts directly onto carpeted bunk boards.
- Works with any standard bunk board.
- Allows the boat to smoothly slide on and off the trailer.

Order No.	Mfg. No. / Description	List Price
578205	(86164) 3" x 16" Sold in Packs of 10	\$41.29 F0-0982000
578367	(86170) 1-3/4" x 17" Sold in Packs of 8	\$25.09 F0-6571000

Tie Down Modular Glide On's



- Self-centering bunk glide on's feature interlocking modular sections make loading and unloading your boat effortless.
- Designed to accommodate 2x6 bunk boards in a variety of lengths up to 16' (or two 8' boards).
- Includes: (4) 3' sections, (4) 1' end sections and mounting hardware.

Order No.	Mfg. No. / Description	List Price
570654	(86295) Black	\$67.49 F0-4274000

Sparta Carpets G015 Bayside Cut Pile Carpet

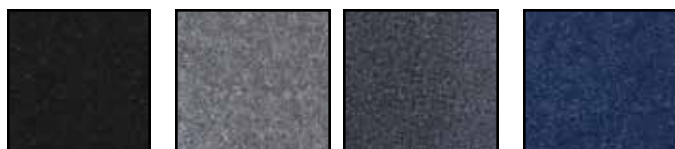

- Our line of 12 oz. cut pile carpet is constructed with UV Stabilized Polypropylene Fiber and comes in a wide variety of colors in various widths for all bunk applications.
- All products are specified with marine back for glue-in or staple applications.
- This carpet is designed for bunk applications.
- Tufted on a 1/8 gauge set-up, this product provides the customer with a superb protection at a competitive price.

Order No.	Mfg. No.	Color	Size	List Price
2004320	(09-100)	Black	12" x 100'	\$157.69 G0-5650100
2004325	(09-12)	Black	12" x 12'	\$19.79 G0-6231000
2004340	(11-100)	Platinum	12" x 100'	\$157.69 G0-5650100
2004345	(11-12)	Platinum	12" x 12'	\$19.79 G0-6231000
2004717	(87-12)	Charcoal	12" x 12'	\$18.39 G0-2321000
2004420	(97-12)	Jasmine	12" x 12'	\$19.79 G0-6231000

Marykate Liquid Rollers® Trailer Bunk Boards Lubricant



- Makes the loading and unloading of boats easy.
- Dramatically reduces friction to make bunk boards as slick as rollers.
- Long-lasting, non-greasy, non-staining formula.
- Repels road dirt and grime.

Order No.	Mfg. No. / Description	List Price
216404	(MK6810) 10 oz.	\$13.59 G0-1190000

Tie Down Bunk Carpet



- Replace worn, frayed bunks with this all-weather marine grade carpet that will resist rot or mildew.
- Each standard 11" x 12' carpet roll will wrap completely around 2x4 boards and around three sides of 2x6 bunk boards.
- Measures 11" wide x 12' long.

Order No.	Mfg. No. / Description	List Price
578366	(86137) Black	\$19.99 F0-9931000

Marpac Trailer Bunk Padding



- Protect your boat from damage and scratches.
- Easy to cut and custom fit.
- Static free and is made for minimal water retention.

Order No.	Description	List Price
7-59110	8" W x 12' L	\$14.99 G0-4001000
7-59111	12" W x 12' L	\$20.29 G0-9531000

Marine & Outdoor Carpet Adhesive

- 776 Marine and Outdoor Carpet adhesive is a high strength, water based adhesive designed for use in the installation of Marine Carpet and most Outdoor Grade Carpets.
- It can be used over plywood, association grade particle board, hardwood, concrete, aluminum and fiberglass.
- It can be used on or below grade.
- Surface should be clean and free from oil, grease, silicone, etc.



Order No.	Mfg. No. / Description	List Price
2044231	(776) Gallon	\$51.79 G0-0743000

- Electronics
- Trolling Motors
- Instruments
- Electrical
- Lighting
- Anchor & Dock
- Safety
- Steering, Controls
- Pumps
- Fuel System
- Seating & Pedestals
- Trailering
- Tops & Covers
- Perform.
- Propellers
- Engine & Care
- Cleaning & Care
- Paint & Paint Acc.
- Fun & Flotation
- Topside Acc.
- Cockpit & Deck
- Hardware, Fasteners
- Camouflage
- Misc.
- Comm.

Tough Guy Swing-Up Trailer Jack



- Fits 3" x 5" trailer tongues.
- 1,000 lbs. maximum tongue weight.
- Provides up to 21" of lift.
- Easy swing-up operation.
- Feel secure with locking pin for added strength and support.
- Non-slip handle for a more comfortable and secure grip.
- Hardware kit included.



Order No.	Description	List Price
7-1585	Swivel Trailer Jack	\$45.49

Tough Guy Swing-Up Trailer Jack



- Fits 3" x 5" trailer tongues.
- 1,500 lbs. maximum tongue weight.
- Provides up to 21" of lift.
- Easy swing-up operation.
- Fell secure with locking pin for added strength and support.
- Smooth turning grip.
- Hardware kit included.



Order No.	Description	List Price
7-1598	Swing-Up Trailer Jack	\$80.99

Fulton Bolt-Thru Swivel Mount Jacks



- The Fulton brand bolt-thru swivel mounts (U.S. PAT. 6,302,381) use 3-D formed heavy gauge steel stampings and a proprietary bushing material for a mount with minimal deflection and maximum support.
- All mounts fit up to a 3" x 5" trailer frame.
- Strong proprietary bushing materials.
- Stable formed heavy-gauge steel construction.
- 10" of travel.
- Mounting hardware for up to 5" frame included.



Order No.	Mfg. No. / Description	List Price
685570	(XP10 0101) 1,200 lbs. (TW/GTW) 6" Wheel	\$101.39
685580	(XP15 0101) 1,500 lbs. (TW/GTW) 8" Wheel	\$138.59

Fulton Dual Wheel Bolt-Thru Swivel Mount Jack



- The Fulton brand bolt-thru swivel mounts (U.S. PAT. 6,302,381) use 3-D formed heavy gauge steel stampings and a proprietary bushing material for a mount with minimal deflection and maximum support.
- All mounts fit up to a 3" x 5" trailer frame.
- Strong proprietary bushing materials.
- Stable formed heavy-gauge steel construction.
- 12" of travel.
- Mounting hardware for up to 5" frame included.
- 1,500 lbs. (TW/GTW).
- 6" dual wheel.



Order No.	Mfg. No. / Description	List Price
685585	(XPD15L0101)	\$173.79

Tough Guy Wide Wheel Swing-Up Trailer Jack



- Fits 3" x 5" trailer tongues.
- 2,000 lbs. maximum tongue weight.
- Provides up to 25" of lift.
- Easy swing-up operation.
- 2X wide wheel rolls smoother, is more stable with less sinking.
- Special zinc plating meets the stringent international ASTM B117 standard for 500 hour salt spray.
- Double pin for added strength and durability.
- Continued smooth operation when lubricated using convenient grease fitting.
- Hardware kit included.



Order No.	Description	List Price
7-1599	Swing-Up Trailer Jack	\$114.69

Tough Guy Replacement Trailer Jack Wheels



Order No.	Description	List Price
7-1620	2" Wide x 6" Diameter	\$10.99
7-1621	2" Wide x 8" Diameter	\$24.79

Marpac Wheel Stop



- Lower your jack wheel into the wheel stop to prevent the tongue from moving.
- Always block your tires.



Order No.	Description	List Price
7-59202	Wheel Stop	\$4.79

- Electronics
- Trailing Motors
- Instruments
- Electrical
- Lighting
- Anchor & Dock
- Safety
- Steering, Controls
- Pumps
- Fuel System
- Seating & Pedestals
- Trailering
- Tops & Covers
- Perform.
- Propellers
- Engine & Care
- Cleaning & Care
- Paint & Paint Acc.
- Fun & Flotation
- Topside Acc.
- Cockpit & Deck
- Hardware, Fasteners
- Camouflage
- Misc.
- Comm.

Tough Guy Drop-Leg Trailer Jack



- Fits 3" x 5" trailer tongues.
- 2,500 lbs. maximum tongue weight.
- Provides up to 31" of lift.
- Zinc plated for corrosion resistance.
- Easy adjustments with quick release thumb pin.
- Continued smooth operation when lubricated using convenient grease fitting.
- Zinc plated hardware kit included.

Order No.	Description	List Price	Mfg. No. / Description
7-1588	Trailer Jack	\$100.89	G0-0676000

Fulton Drop-Leg Jack



- Heavy duty square.
- Strong proprietary bushing materials.
- Stable formed heavy-gauge steel construction.
- Dependable design.
- 3.8" x 7.5" footplate.
- Bolt-on.
- Mounting hardware for up to 5" frame included.
- 28" of travel - includes drop leg.
- 2,500 lbs. (TW/GTW).

Order No.	Mfg. No. / Description	List Price	Mfg. No. / Description
685590	(HD25000101)	\$139.09	F0-6379000

Tough Guy A-Frame Jack



- Heavy duty 2,000 lb. capacity round A-frame side wind jack.
- 13" of vertical travel.
- Retracted length of 8-1/2", extended length of 21-1/2".
- Corrosion resistant black powder coated finish.
- Strong 2" diameter tube.
- Either weld-on or bolt-on (bolts not included).
- Slotted universal fit mounting bracket.
- Note: Ground support must be purchased separately.

Order No.	Description	List Price	Mfg. No. / Description
7-1615	A-Frame Jack	\$52.19	G0-7943000

FOOT PLATE

- For use with 7-1615 A-Frame Jack or similar jacks with 2" round tube.
- Supports up to 3,000 lb.
- Measures: 6.7" x 5".

Order No.	Description	List Price	Mfg. No. / Description
7-1616	Foot Plate	\$14.79	G0-1990000

JACK CASTOR

- For use with 7-1615 A-Frame Jack or similar jacks with 2" round tube.
- Supports up to 1,200 lb.
- 6" diameter x 2" wide wheel.

Order No.	Description	List Price	Mfg. No. / Description
7-1617	Jack Castor	\$26.29	G0-1671000

Fulton Fas-Lok® Straight Trailer Couplers

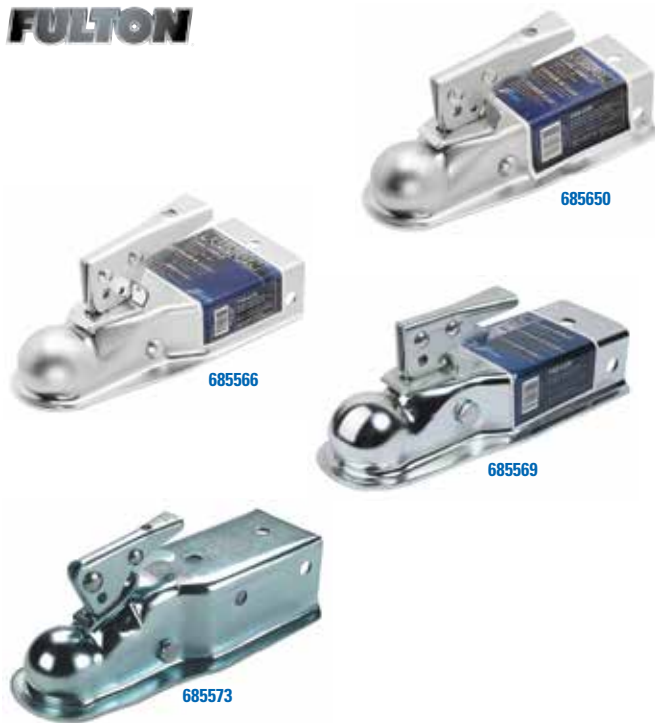

- Stamped, straight channel.
- Zinc finish.
- Quick and easy trailer hook-up.
- Limited 5 year warranty.

CLASS I. 2,000 lbs. (TW/GTW).

- Ball size: 1-7/8".

Order No.	Mfg. No. / Description	List Price	Mfg. No. / Description
685550	(11250 0101) 2-1/2" Wide Channel	\$26.89	F0-2881000
685566	(11300 0101) 3" Wide Channel	\$26.89	F0-2881000

CLASS II. 3,500 lbs. (TW/GTW).

- Ball size: 2".

Order No.	Mfg. No. / Description	List Price	Mfg. No. / Description
685569	(22300 0101) 3" Wide Channel	\$30.49	F0-4312000

CLASS III. 5,000 lbs. (TW/GTW).

- Ball size: 2".

Order No.	Mfg. No. / Description	List Price	Mfg. No. / Description
685573	(34300 0301) 3" Wide Channel	\$40.39	F0-7282000

- Electronics
- Trolling Motors
- Instruments
- Electrical
- Lighting
- Anchor & Dock
- Safety
- Steering, Controls
- Pumps
- Fuel System
- Seating & Pedestals
- Trailer
- Tops & Covers
- Perform.
- Propellers
- Engine & Care
- Cleaning & Care
- Paint & Paint Acc.
- Fun & Flotation
- Topside Acc.
- Cockpit & Deck
- Hardware, Fasteners
- Camouflage
- Misc.
- Comm.

Marpac Trailer Hitch Balls



- Chrome plated steel.
- Includes lock washer and nut.
- V5 compliant.
- Independently tested to SAE J684 specs.

Order No.	Description	List Price	
7-0150	Ball Diameter 1-7/8" Shaft 3/4" x 1-1/2"	\$7.99	G0-5350000
7-0145	Ball Diameter 1-7/8" Shaft 3/4" x 2-3/8"	\$9.69	G0-9460000
7-0147	Ball Diameter 1-7/8" Shaft 1" x 2-1/8"	\$10.49	G0-3070000
7-0146	Ball Diameter 2" Shaft 3/4" x 2-3/8"	\$10.09	G0-6760000
7-0148	Ball Diameter 2" Shaft 1" x 1-1/8"	\$10.89	G0-0370000
7-0152	Ball Diameter 2-5/16" Shaft 1" x 2"	\$13.99	G0-7390000
7-0153	Ball Diameter 2-5/16" Shaft 1-1/4" x 2-1/2"	\$16.09	G0-8701000

Tough Guy Ball Mounts

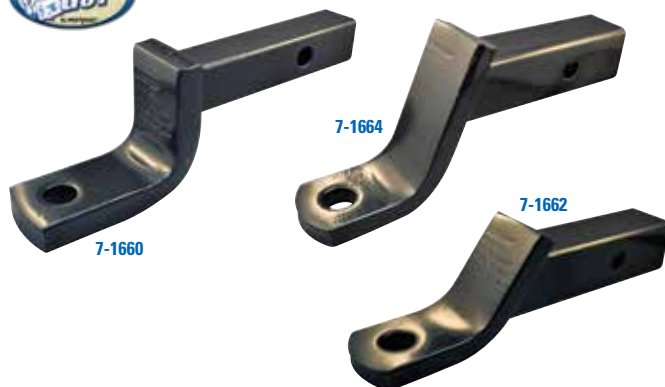

CLASS II

- 2-1/2" powder coated ball drop.
- Fits 1-1/4" square receivers.
- 7" shank.
- 3,500 lb. gross trailer weight.
- 300 lb. tongue weight.
- Use with any trailer ball with 3/4" shank diameter.
- Note: Trailer ball and hitch pin sold separately.

Order No.	Description	List Price	
7-1660	Ball Mount	\$20.99	G0-6041000

CLASS IV

- Fits 2" square receivers.
- 8" shank.
- 6,000 lb. gross trailer weight.
- 600 lb. tongue weight.
- Use with any trailer ball with 1" shank diameter.
- Note: Trailer ball and hitch pin sold separately.

Order No.	Description	List Price	
7-1662	2" Powder Coated Ball Drop	\$21.99	G0-3741000
7-1664	4" Powder Coated Ball Drop	\$26.49	G0-5771000

Tough Guy Tri-Ball Hitch



- Versatile mount includes 1-7/8", 2" and 2-5/16" chrome trailer balls.
- Rated for: 2,000 lb. (1-7/8"), 6,000 lb. (2") and 10,000 lb. (2-5/16") GTW.
- Solid, powder coated shank for heavy duty towing.
- Fits 2" square receivers.
- 5/8" hitch pin hole (hitch pin sold separately).

Order No.	Description	List Price	
7-1666	Tri-Ball Hitch	\$71.29	G0-6774000

Marpac Complete Towing Kit



- 2" powder coated drop ball mount.
- Handles trailers up to 6,000 lbs.
- Includes: 2" trailer ball rated at 6,000 lbs. (1" shaft diameter).
- Max tongue weight up to 600 lbs.
- Use with 2" x 2" receiver.
- Includes 5/8" hitch pin.
- Help keep the tow vehicle cleaner with the convenient storage case.

Order No.	Description	List Price	
7-1869	Complete Towing Kit	\$43.29	G0-0092000

- Electronics
- Trolling Motors
- Instruments
- Electrical
- Lighting
- Anchor & Dock
- Safety
- Steering, Controls
- Pumps
- Fuel System
- Seating & Pedestals
- Trailer
- Tops & Covers
- Perform.
- Propellers
- Engine & Care
- Cleaning & Care
- Paint & Paint Acc.
- Fun & Flotation
- Topside Acc.
- Cockpit & Deck
- Hardware, Fasteners
- Camouflage
- Misc.
- Comm.

Tough Guy Trailer Safety Chains



- Zinc plated.
- Contains: S-hooks on both ends.

Order No.	Description		Length	List Price	
7-1850	Class II 3/16" x 28 Links		Length 31"	\$15.79	G0-8501000
7-1851	Class III 1/4" x 26 Links		Length 31"	\$17.19	G0-2511000

Master Lock Python™ Adjustable Locking Cable



- Patented adjustable locking mechanism holds cable tight at any position for perfect fit.
- Braided steel for strength and flexibility.
- Cable end threads through places other cables cannot.
- Integrated pin tumbler keyed locking mechanism for superior pick resistance.
- Rust resistant lock and vinyl coated cable for superior weather and scratch resistance.
- Strap holds excess cable for compact storage.

Order No.	Mfg. No. / Description	List Price	
2001304	(8418D)	\$26.29	G0-1671000

Tie Down "S" Hook Chain Keepers



- These patented safety chain keepers attach easily to the "S" hooks to keep your chains secured to the vehicle.
- Required in some states.
- Packed 2 per package.

Order No.	Mfg. No. / Description	List Price	
579630	(81255)	\$5.09	F0-6530000

Tough Guy Coupler Locking Pin



- Steel, electro-galvanized.
- Length 3", 1/4".

Order No.	Description	List Price	
7-0895	Coupler Locking Pin	\$2.29	G0-3510000

Tie Down Trailer Safety Chain



- Zinc plated trailer safety chains are packed in pairs with S-hooks.
- Class 4, 5/16" x 26 links.
- Overall length 40-3/4".

Order No.	Mfg. No. / Description	List Price	
333574	(81204)	\$31.59	F0-1122000

Tie Down Hitch Cables



- Replace your noisy chains with self-coiling hitch cables.
- Available uncoated or black vinyl coated.
- Uses durable galvanized aircraft cable construction.
- Exceeds SAE J684 standards for trailer coupling and automotive type hitches.
- NMMA Certified.
- Each pair extends 36" in length.
- Cables with S-hooks are packaged for great looking displays.

GALVANIZED WITH WIRE SAFETY LATCH

Order No.	Mfg. No. / Description	Capacity	List Price	
5765027	(59539) Class 3	Capacity 5,000 lbs.	\$22.79	F0-5951000

BLACK VINYL JACKETED WITH WIRE SAFETY LATCH

Order No.	Mfg. No. / Description	Capacity	List Price	
579613	(59537) Class 2	Capacity 3,500 lbs.	\$17.89	F0-2521000
579620	(59541) Class 3	Capacity 5,000 lbs.	\$22.59	F0-1851000
5765029	(59545) Class 4	Capacity 7,000 lbs.	\$26.49	F0-4581000

BLACK VINYL JACKETED WITH SAFETY LATCH HOOK

Order No.	Mfg. No. / Description	Capacity	List Price	
5765030	(59548) Class 4	Capacity 7,000 lbs.	\$27.19	F0-3091000

Tough Guy Trailer Coupler Safety Pin



- Zinc plated.
- Rounded.

Order No.	Description	List Price	
7-59401	Trailer Coupler Safety Pin	\$2.39	G0-0610000

Electronics

Trolling Motors

Instruments

Electrical

Lighting

Anchor & Dock

Safety

Steering, Controls

Pumps

Fuel System

Seating & Pedestals

Trailer

Tops & Covers

Perform.

Propellers

Engine & Care

Cleaning & Care

Paint & Paint Acc.

Fun & Flotation

Topside Acc.

Cockpit & Deck

Hardware, Fasteners

Camouflage

Misc.

Comm.

Tough Guy Hitch Pin



- Zinc plated for corrosion resistance.
- 5/8" hitch pin fits Class III and Class IV hitches.
- Hairpin cotter won't vibrate free.

Order No.	Description	List Price	Mfg. No. / Description
7-1868	Hitch Pin	\$4.59	GO-8030000

Master Lock Bent Receiver Pin with Sleeve



- Fits both 1/2" and 5/8" receivers.
- Usable length of receiver pin is 2-1/2".
- Hardened steel for improved cut and shear resistance.
- Tapered ends for easy insertion.
- Limited Lifetime Warranty.

Order No.	Mfg. No. / Description	List Price
2001270	(1376DAT)	\$6.89 GO-2640000

Master Lock Stainless Steel Barrel Head Hitch Pin



- Stainless steel hitch pin fits 5/8" receivers.
- Usable length of receiver pin is 3".
- Stainless steel for corrosion resistance.
- Class III/IV rating.
- Tapered ends for easy insertion.
- Limited Lifetime Warranty.

Order No.	Mfg. No. / Description	List Price
2001272	(1465DAT)	\$12.89 GO-4680000

Tough Guy Locking Receiver Pin



- Chrome plated for corrosion resistance.
- Safety and security, helps prevent thefts.
- Fits Class III and Class IV hitches (2" x 2").
- Key slot cover protects lock mechanism.
- Pin diameter: 5/8".
- Fits 1/4" trigger style couplers.

Order No.	Description	List Price	Mfg. No. / Description
7-1867	Locking Receiver Pin	\$12.19	GO-7180000

Master Lock Bent Receiver Pin



- Fits 5/8" receivers.
- Usable length of receiver pin is 2-1/2"
- Hardened steel for improved cut and shear resistance.
- Tapered ends for easy insertion.
- Limited Lifetime Warranty.

Order No.	Mfg. No. / Description	List Price
2001293	(371DAT)	\$3.79 GO-4520000

Master Lock Receiver Pin and Clip



- Fits both 1/2" and 5/8" receivers.
- Usable length of receiver pin is 3".
- 1/2" pin is rated for Class I/II and 5/8" pin is rated for Class III/IV.
- Hardened steel for improved cut and shear resistance.
- Chrome plated.
- Tapered ends for easy insertion.
- Limited Lifetime Warranty.

Order No.	Mfg. No. / Description	List Price
2001271	(1414DAT)	\$7.29 GO-8840000

Master Lock Barrel Head Hitch Pin



- Fits 5/8" receivers.
- Usable length of receiver pin is 3".
- Class III/IV rating.
- Chrome plated.
- Tapered ends for easy insertion.
- Hardened steel for improved cut and shear resistance.
- Limited Lifetime Warranty.

Order No.	Mfg. No. / Description	List Price
2001277	(1495DAT)	\$6.29 GO-1240000

Bulldog Easy Access Adjustable Coupler Lock



- Includes dust cap.
- Easy access models feature side key entry, sliding dust cap, lock housing rotates 360°.

Order No.	Mfg. No. / Description	List Price
685586	(580410)	\$21.89 FO-2351000

Electronics

Trolling Motors

Instruments

Electrical

Lighting

Anchor & Dock

Safety

Steering, Controls

Pumps

Fuel System

Seating & Pedestals

Trailering

Tops & Covers

Perform.

Propellers

Engine & Care

Cleaning & Care

Paint & Paint Acc.

Fun & Flotation

Topside Acc.

Cockpit & Deck

Hardware, Fasteners

Camouflage

Misc.

Comm.

Marpac Hitchlock Trailer Coupler Lock



- Solid cast, heat treated for toughness.
- Helps prevent trailer theft.
- Will not corrode, rust or clog.
- Fits all Fas-Lok and other standard couplers.

Order No.	Description	List Price
7-0899	Hitchlock Trailer Coupler Lock	\$6.79 G0-5540000

Master Lock Tumbler Padlock with Shrouded Shackle



- 1-9/16" shrouded laminated steel body for superior strength.
- Armored hardened steel shackle defies cutting.
- Shackle fits openings 1/2" in diameter or larger; shackle guard removable to accommodate openings 9/32" in diameter.
- Dual locking levers provide extra pry resistance.
- 4-pin cylinder helps prevent picking.
- Shackle guard protects against bolt cutters and hacksaws.
- Limited Lifetime Warranty.

Order No.	Mfg. No. / Description	List Price
2001300	(37D)	\$19.69 G0-9131000

Fulton Universal Trailer Coupler Lock



- Durable cast body.
- Fits all 1-7/8", 2" and 2-5/16" couplers.
- Guards against trailer towaway theft.
- Advanced locking mechanism resists picking and prying.

Order No.	Mfg. No. / Description	List Price
357113	(72783)	\$25.99 F0-9181000

Master Lock Trailer Coupler Lock



- Fits 1-7/8", 2" and most 2-5/16" trailer couplers.
- Advance locking mechanism resists picking and prying.
- Easy to install and remove.
- Resists rust and corrosion.
- Limited Lifetime Warranty.

Order No.	Mfg. No. / Description	List Price
2001294	(377DAT)	\$49.49 G0-6133000

Tough Guy Hitch Lock



- Safety and security, helps prevent thefts.
- Fits Class III and Class IV hitches (2" x 2"), 5/8" pin diameter.
- Chrome plated for corrosion resistance.
- Key slot has cover to protect lock mechanism.

Order No.	Description	List Price
7-1866	Hitch Lock	\$11.99 G0-3080000

Master Lock Trailer Coupler Latch Lock



- 3-1/2" long shackle fits UFP couplers.
- Hardened steel for improved cut and shear resistance.
- K1 key blank.
- Limited Lifetime Warranty.

Order No.	Mfg. No. / Description	List Price
2001274	(1471DAT)	\$21.19 G0-0241000

Master Lock Stainless Steel Receiver Lock



- Stainless steel keyed alike receiver lock and coupler latch lock.
- 5/8" receiver lock has Push to Lock locking mechanism - push lock body onto pin firmly and remove key.
- Usable length of receiver pin is 2-3/4".
- Weather Tough seal and water tight cap protects lock from moisture and dirt.
- Adjustable coupler latch lock; locks from 9/16" to 2-3/4".
- K1 Key Blank.
- Limited Lifetime Warranty.

Order No.	Mfg. No. / Description	List Price
2001276	(1481DAT)	\$40.69 G0-6272000

- Electronics
- Trolling Motors
- Instruments
- Electrical
- Lighting
- Anchor & Dock
- Safety
- Steering, Controls
- Pumps
- Fuel System
- Seating & Pedestals
- Trailer
- Tops & Covers
- Perform.
- Propellers
- Engine & Care
- Cleaning & Care
- Paint & Paint Acc.
- Fun & Flotation
- Topside Acc.
- Cockpit & Deck
- Hardware, Fasteners
- Camouflage
- Misc.
- Comm.



O'Neill Manufacturing/Rod Saver Personalized Tie Downs

Secure your future with Rod Saver and Donovan Marine.

- O'Neill Manufacturing, Inc. and Donovan Marine offers two of O'Neill's most popular tie downs with your dealership name embroidered on the buckle wrap.
- Choose from the Paddle Buckle or Quick Release over-the-center style buckles.



Information Needed:

Monogram Name (20 letters or less):

Letter Style #:

Thread Color:

Choose from: Red Dark Blue Light Blue White Yellow Green Chartreuse Green Tan

Letter Style Choices:

Style #	Description	Example
1	Block	ABDCEFGHIJKLMNOPQRSTUVWXYZabcdefghijklmnopqrstuvwxyz
2	Sea Breeze	<i>ABDCEFGHIJKLMNOPQRSTUVWXYZabcdefghijklmnopqrstuvwxyz</i>
3	Old Style	ABDCEFGHIJKLMNOPQRSTUVWXYZabcdefghijklmnopqrstuvwxyz
4	Script	<i>ABDCEFGHIJKLMNOPQRSTUVWXYZabcdefghijklmnopqrstuvwxyz</i>
5	Flares	ABDCEFGHIJKLMNOPQRSTUVWXYZabcdefghijklmnopqrstuvwxyz
6	Chancery	<i>ABDCEFGHIJKLMNOPQRSTUVWXYZabcdefghijklmnopqrstuvwxyz</i>
7	Hobo	ABDCEFGHIJKLMNOPQRSTUVWXYZabcdefghijklmnopqrstuvwxyz
8	Old English	ABDCEFGHIJKLMNOPQRSTUVWXYZabcdefghijklmnopqrstuvwxyz
9	Serif3	ABDCEFGHIJKLMNOPQRSTUVWXYZabcdefghijklmnopqrstuvwxyz



Paddle Buckle



Quick Release

Order No.	Mfg. No. / Description	List Price
_____ (2PB2)	Paddle Buckle 2" x 2" Pair	Price on Request
_____ (2PB4)	Paddle Buckle 2" x 4" Pair	Price on Request
_____ (QRTD2)	Quick Release 2" x 2" Pair	Price on Request
_____ (QRTD4)	Quick Release 2" x 4" Pair	Price on Request

Star Brite Custom Embroidered Transom Tie Downs



- Thread color choices: Red, blue, white, yellow, gold, teal, and neon green.
- No additional charge for standard or script type lettering.
- No more than 13 characters per line, imprint area 2" x 3", three imprint line available.
- Custom digitized logos available.

Order No.	Mfg. No. / Description	Price on Request
S/O	(60070) 2" x 2' Transom Tie Down, Bulk	Price on Request
S/O	(60062) 2" x 3' Transom Tie Down, Bulk	Price on Request
S/O	(60072) 2" x 4' Transom Tie Down, Bulk	Price on Request
S/O	(60079) 2" x 5' Transom Tie Down, Bulk	Price on Request

Special Order Only Minimum Order 25 Pair

- Electronics
- Trolling Motors
- Instruments
- Electrical
- Lighting
- Anchor & Dock
- Safety
- Steering, Controls
- Pumps
- Fuel System
- Seating & Pedestals
- Trailer
- Tops & Covers
- Perform.
- Propellers
- Engine & Care
- Cleaning & Care
- Paint & Paint Acc.
- Fun & Flotation
- Topside Acc.
- Cockpit & Deck
- Hardware, Fasteners
- Camouflage
- Misc.
- Comm.

- Electronics
- Trolling Motors
- Instruments
- Electrical
- Lighting
- Anchor & Dock
- Safety
- Steering, Controls
- Pumps
- Fuel System
- Seating & Pedestals
- Trailer
- Tops & Covers
- Perform.
- Propellers
- Engine & Care
- Cleaning & Care
- Paint & Paint Acc.
- Fun & Flotation
- Topside Acc.
- Cockpit & Deck
- Hardware, Fasteners
- Camouflage
- Misc.
- Comm.

Tough Guy Deluxe Gunwale Tie Downs with S-hook and Snap Hook



- Heavy duty 2" wide webbing. Protective pads.
- Buckle locks securely, is easy to adjust.
- Corrosion resistant S-hook and snap hook.
- Made in USA.

Order No.	Description	List Price
7-2120	Length 8'	\$16.09 G0-8701000
7-2121	Length 10'	\$16.79 G0-5211000
7-2122	Length 12'	\$17.29 G0-8511000
7-2123	Length 14'	\$17.49 G0-2711000
7-2124	Length 16'	\$17.99 G0-5021000

Tough Guy Gunwale Tie Downs with J-hook Ends



- Heavy duty 2" wide webbing.
- Buckle locks securely, is easy to adjust.
- Corrosion resistant J-hooks.
- Made in USA.



Order No.	Description	List Price
7-2100	Length 10'	\$13.49 G0-4090000
7-2101	Length 12'	\$13.99 G0-7390000
7-2102	Length 14'	\$14.39 G0-4690000
7-2103	Length 16'	\$14.89 G0-8990000
7-2105	Length 20'	\$12.09 G0-0180000

Tough Guy Transom Tie Downs



- Can be quickly adjusted.
- Protective pad.
- Sold in pairs.
- Made in USA.

Order No.	Description	List Price
7-2130	Length 2' 2" Wide	\$24.09 G0-4161000
7-2133	Length 3-1/2' 1" Wide, Adjustable	\$24.29 G0-7261000

Tough Guy Heavy Duty Retractable Transom Tie Down



- The safe and easy way to secure a boat to the trailer.
- Unique ratcheting action has two-step release to prevent accidental release.
- Mounting hardware included.
- Made in USA.

Order No.	Description	List Price
7-2140	Length 40"	\$99.99 G0-9966000

Tough Guy Transom Straps

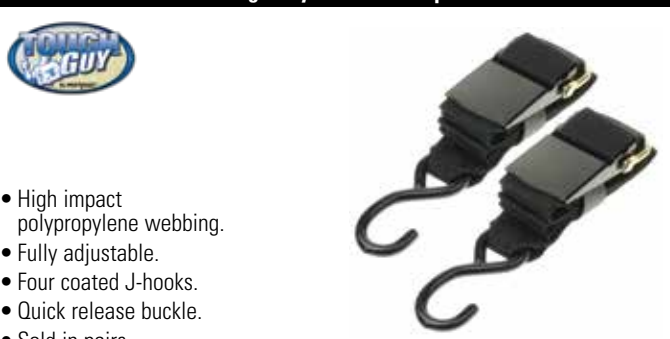

- High impact polypropylene webbing.
- Fully adjustable.
- Four coated J-hooks.
- Quick release buckle.
- Sold in pairs.

Order No.	Description	List Price
7-59784	2" W x 2' L	\$15.19 G0-8101000
7-59810	2" W x 4' L	\$19.49 G0-6031000

Tough Guy Ratchet Tie Down



- Heavy duty 1" wide webbing.
- Easy-adjust ratchet. Coated S-hooks.
- Made in USA.

Order No.	Description	List Price
7-2136	Length 14'	\$15.99 G0-1701000

Tough Guy Ratchet Strap



- High impact polyester webbing.
- Fully adjustable.
- Quick release buckle.
- Two coated S-hooks.
- Sold each.

Order No.	Description	List Price
7-59802	2" W x 14' L	\$24.09 H0-5441000

Rod Saver Deluxe Trailer Tie Downs



- Our finest over-center locking buckle with wrap around buckle protection that is proven to stay clamped under the worst road conditions.
- It features American made heavy vinyl coated top hook and zinc plated bottom hook.
- Sold in pairs.

Order No.	Mfg. No. / Description	Rated Capacity	List Price	
2003840	(TTD2) 2" W x 2' L	1,700 lbs.	\$29.09	F0-6302000
2003845	(TTD4) 2" W x 4' L	1,700 lbs.	\$30.99	F0-9612000

Rod Saver Retractable Transom Tie Down



- One of the best ways to secure your boat to the trailer.
- It swivels to ensure that webbing is pulled in a straight line to the boat transom eye.
- It also features an easy squeeze release mechanism, which enables you to quickly and conveniently secure the boat.
- Adjustable up to 48".
- Sold in pairs.

Order No.	Mfg. No. / Description	Rated Capacity	List Price	
2003820	(RT40) Rated Capacity: 1,800 lbs.		\$84.39	F0-7095000

Rod Saver Paddle Buckle Tie Downs



- Made with a paddle buckle, polypropylene belt and protective pad with hook and loop closure for boat protection.
- It features American made heavy vinyl coated top hook and zinc plated bottom hook.
- Sold in pairs.

Order No.	Mfg. No. / Description	Rated Capacity	List Price	
2003760	(1PB4) 1" W x 4' L	1,000 lbs.	\$22.99	F0-9061000
2003765	(2PB2) 2" W x 2' L	1,000 lbs.	\$24.89	F0-2471000
2003775	(2PB4) 2" W x 4' L	1,000 lbs.	\$25.79	F0-5081000
2003785	(2PB6) 2" W x 6' L	1,000 lbs.	\$26.79	F0-5781000

BoatBuckle Retractable Transom Tie Down System



2000942



- Mount permanently to your trailer!
- This tie down system is submersible and water-resistant.
- Tie downs extend up to 48" and retract automatically.
- No more lost or knotted tie downs!

Order No.	Mfg. No. / Description	List Price	
2000939	(F08893)	\$120.09	H0-5027000
2000942	(F14254) Mounting Bracket	\$15.19	H0-1190000

- Electronics
- Trolling Motors
- Instruments
- Electrical
- Lighting
- Anchor & Dock
- Safety
- Steering, Controls
- Pumps
- Fuel System
- Seating & Pedestals
- Trailer
- Tops & Covers
- Perform.
- Propellers
- Engine & Care
- Cleaning & Care
- Paint & Paint Acc.
- Fun & Flotation
- Topside Acc.
- Cockpit & Deck
- Hardware, Fasteners
- Camouflage
- Misc.
- Comm.

Electronics

Trolling Motors

Instruments

Electrical

Lighting

Anchor & Dock

Safety

Steering, Controls

Pumps

Fuel System

Seating & Pedestals

Trailer

Tops & Covers

Perform.

Propellers

Engine & Care

Cleaning & Care

Paint & Paint Acc.

Fun & Flotation

Topside Acc.

Cockpit & Deck

Hardware, Fasteners

Camouflage

Misc.

Comm.

Tough Guy Hub Kits



- Includes: Hub, (2 each) bearings, 1/2" lug nuts, (1 each) grease seal, (1 each) cotter key and (1 each) dust cap.

4 STUD HUB

Order No.	Description	List Price	
7-0710	1250#, 1" Bearings, 4 Lug Nuts	\$40.99	GO-6472000

5 STUD HUB

Order No.	Description	List Price	
7-0711	1250#, 1" Bearings, 5 Lug Nuts	\$38.69	GO-2952000
7-0712	1350#, 1-1/16" Bearings, 5 Lug Nuts	\$39.09	GO-9162000
7-0713	1750#, 1-1/16" and 1-3/8" Bearings, 5 Lug Nuts	\$59.59	GO-3993000

Dexter Vortex Hub Kits



- Feature a 6 year/100,000 mile zero maintenance warranty.
- Completely sealed lubrication reservoir chamber permits maximum lubrication.
- Easily accessible external lubrication port fitting.
- Triple lip spring loaded seal provides improved sealing over single and double lip seals.
- Kits include: Bearings, seals, dust cap, cotter pin and lug nuts.
- Hub assembly comes pre-greased with Lucas Red N Tacky grease providing wear protection in tough marine environments.
- E-Coat Finish.

5 STUDS

Order No.	Mfg. No. / Description	List Price	
657642	(K08-528-98) 1,750#, 1 Each 1-1/16" & 1-3/8" Bearings	\$106.99	FO-9847000

VORTEX HUB REPLACEMENT CAP ASSEMBLY - SOLD 2 PER PACK

Order No.	Mfg. No. / Description	List Price	
570630	(K71-G01-73) For Use with 1,250# - 1,750# Hubs	\$31.99	FO-9322000

Dexter Replacement Wheel Hub Kits



- Kits include: Bearings, seals, dust cap, cotter pin and lug nuts or bolts.
- Hub assembly comes pre-greased with Lucas Red N Tacky grease providing wear protection in tough marine environments.
- Painted finish.

Dexter GalvX Coated Wheel Hub Kits



- Corrosion resistant GalvX Finish.
- Kits include: Bearings, seals, dust cap, cotter pin and lug nuts.
- Hub assembly comes pre-greased with Lucas Red N Tacky grease providing wear protection in tough marine environments.
- (5) 1/2"-20 studs with lug nuts on a 4.5" bolt pattern.

5 STUD HUB

Order No.	Mfg. No. / Description	List Price	
657646	(81083) 1,250#, 2 Each 1" Bearings	\$69.59	FO-1784000
657657	(K08-526-9A) 1,350#, 2 Each 1-1/16" Bearings	\$68.79	FO-5184000
657669	(K08-523-96) 1,750#, 1 Each 1-1/16" & 1-3/8" Bearings	\$80.49	FO-4365000

Dexter Super Lube Hub Kits



- Super Lube hubs have a maintenance feature that allows easy addition and replacement of grease using a zerk fitting on the back of the hub.
- Kits include: Bearings, seals, dust cap, cotter pin and lug nuts.
- Hub assembly comes pre-greased with Lucas Red N Tacky grease providing wear protection in tough marine environments.
- Painted Finish.

4 STUDS

Order No.	Mfg. No. / Description	List Price	
657683	(K08-523-9C) 1,250#, 2 Each 1" Bearings	\$73.49	FO-4415000
657695	(K08-523-94) 1,350#, 2 Each 1-1/16" Bearings	\$79.59	FO-1755000

5 STUDS

Order No.	Mfg. No. / Description	List Price	
657722	(81035) 1,250#, 2 Each 1" Bearings	\$77.99	FO-9545000
657734	(K08-523-9B) 1,350#, 2 Each 1-1/16" Bearings	\$71.29	FO-0994000
657746	(K08-528-97) 1,750#, 1 Each 1-1/16" & 1-3/8" Bearings	\$87.59	FO-1316000

4 LUG BOLTS

Order No.	Mfg. No.	Capacity	Bearing Size	List Price	
5765050	(K08-524-90)	1,250#	1" Inner and Outer	\$53.29	FO-0373000
5765051	(K08-524-91)	1,350#	1-1/16" Inner and Outer	\$53.89	FO-2773000

4 STUDS

Order No.	Mfg. No.	Capacity	Bearing Size	List Price	
5765052	(K08-523-G6)	1,250#	1" Inner and Outer	\$57.69	FO-8304000
5765053	(K08-523-G0)	1,350#	1-1/16" Inner and Outer	\$57.69	FO-8304000

5 LUG BOLTS

Order No.	Mfg. No.	Capacity	Bearing Size	List Price	
5765055	(K08-527-93)	1,250#	1" Inner and Outer	\$56.99	FO-9893000

5 STUDS

Order No.	Mfg. No.	Capacity	Bearing Size	List Price	
5765061	(K08-436-G0)	1,750#	1-3/8" Inner & 1-1/16" Outer	\$70.09	FO-6094000

Marpac Wheel Bearing Kits

- Precision tapered roller bearings.
- Each kit includes: (2) Cones, (2) cups, seal and cotter pin.
- Dust cap shown sold separately.



Order No.	Spindle	Outer Hub	Race OD	List Price	
7-0952	3/4"	1.781		\$15.79	GO-8501000
7-0953	1"	1.980		\$14.09	GO-4490000
7-0954	1-1/16"	1.980		\$13.49	GO-4090000
7-0956	1-1/4"	2.328		\$18.29	GO-5221000
7-0959	1-1/16" x 3/4"	1.781		\$16.09	GO-8701000
7-0957	1-1/4" x 3/4"	1.781		\$15.89	GO-5601000
7-0958	1-3/8" x 1-1/16"	1.980	2.361	\$14.99	GO-4001000
7-0955	1-3/8" x 1-1/16" w/Special Cup	1.980	2.328	\$16.69	GO-8111000

Dexter Turbo Lube Replacement Cap



- OEM replacement cap for Turbo Lube oil bath hubs with capacities of 1,750# and less.
- Cap is threaded and fitted with an O-ring and rubber plug to seal the front end of Turbo Lube hubs.
- Sold each.

Order No.	Mfg. No. / Description	List Price	
5765026	(48399GA)	\$12.19	F0-3580000

Dexter Replacement Bearing Kits



- Kits include: (2) Bearings, (2) races/cups, grease seal and cotter pin.
- "Spot On" bearing reference color coded system for quick reference.

Order No.	Mfg. No.	Bearing Size	"Spot On"	List Price	
5765069	(K71-G02-47)	3/4"	White	\$21.29	F0-0941000
5765074	(K71-G02-32)	1-1/16" x 3/4"	Yellow/White	\$22.39	F0-7651000
5765077	(K71-G02-30)	1-3/8"	Red	\$20.59	F0-1441000

Dexter Replacement Races/Cups



- Sold per pair.

Order No.	Mfg. No.	Bearing Size	"Spot On"	List Price	
5765106	(81301)	3/4"	White	\$7.89	F0-2550000
5765109	(K71-G01-34)	1"	Green	\$7.59	F0-1350000
5765113	(K71-G01-33)	1-3/8"	Red	\$7.29	F0-0150000

Dexter Replacement Grease Seals

- Typical application: Ranger. Shaft diameter: 1.68". Seal type: DL.
- Sold each.

Order No.	Mfg. No.	Bore Diameter	Case Width	List Price	
5765011	(11087)	2.33"	.310"	\$3.69	F0-8520000
5765012	(11097)	2.55"	.500"	\$3.89	F0-2720000

Marpac Replacement Bearing Seals



- Sold per pair.

Order No.	Description	List Price	
7-1861	Lip Seal 1" for 3/4"	\$10.39	GO-6960000
7-1860	Lip Seal 1-1/4" for 1" and 1-1/16"	\$6.79	GO-5540000
7-1862	Lip Seal 1-1/2" for 1-1/4"	\$9.09	GO-9060000
7-1863	Lip Seal 1-3/4" for 1-3/8"	\$6.19	GO-5140000

Dexter Replacement Bearings



- Sold per pair.

Order No.	Mfg. No.	Bearing Size	"Spot On"	List Price	
5765107	(K71-G00-08)	1"	Green	\$13.69	F0-8590000
5765108	(K71-G00-09)	1-1/16"	Yellow	\$13.49	F0-4490000
5765110	(K71-G00-10)	1-1/4"	Blue	\$15.59	F0-1901000
5765112	(K71-G00-11)	1-3/8"	Red	\$13.29	F0-0390000

Dexter Replacement Grease Seals



- Sold per pair.

Order No.	Mfg. No.	Seal Size	Lips Seals	Fits	List Price	
5765114	(K71-G01-77)	1-1/4"	3	1" & 1-1/16" Bearings	\$4.69	F0-8230000
5765115	(K71-G01-79)	1-1/2"	1	1-1/4" Bearings	\$7.89	F0-2550000
5765116	(K71-G01-80)	1-3/4"	3	1-3/8" Bearings	\$5.19	F0-3630000



- Electronics
- Trolling Motors
- Instruments
- Electrical
- Lighting
- Anchor & Dock
- Safety
- Steering, Controls
- Pumps
- Fuel System
- Seating & Pedestals
- Trailering
- Tops & Covers
- Perform.
- Propellers
- Engine & Care
- Cleaning & Care
- Paint & Paint Acc.
- Fun & Flotation
- Topside Acc.
- Cockpit & Deck
- Hardware, Fasteners
- Camouflage
- Misc.
- Comm.

Marpac Spring-Loaded Bearing Protectors



- Steel spring keeps hub grease under pressure, guarding against water seepage and failure. Grease fitting in cap.
- Sold per pair.

Order No.	Description	List Price	
1-59036	1.781"	\$23.19	HO-1931000
7-59038	1.980"	\$21.79	HO-7031000
1-59040	2.328"	\$26.69	HO-1061000

Marpac Bearing Protector Caps



- Helps to protect your bearings against damage from water and dirt entering the wheel bearings.
- Sold per pair.

Order No.	Description	List Price	
7-59030	1.980"	\$3.19	GO-4120000

Bearing Buddy® - Stainless Steel



- Prevents wheel bearing failure by keeping water and dirt out of hubs.
- (Insert decimal point after first digit in Model No. for hub I.D. size).

Order No.	Mfg. No. / Description	List Price	
231605	(41204) 1781SS	\$28.89	FO-2202000
231617	(42304) 1938SS	\$31.09	FO-6712000
231629	(42604) 1968SS	\$31.09	FO-6712000
231631	(42104) 1980SS	\$28.09	FO-6691000
231634	(43104) 2328SS	\$38.09	FO-6662000

Bearing Buddy® with Auto Check - Stainless Steel



- Works like the regular Bearing Buddy, but has new exclusive Auto Check visual lubricant level and pressure indicator.
- When the hub is full of grease, the blue Auto Check ring rests about 1/8" outward from the steel retaining ring.
- A spring loaded piston behind the Auto Check ring pushes against the grease which generates pressure inside the hub to keep water out, thus offering the bearing protection.
- Fits 1.980" bore hole diameter.

Order No.	Mfg. No. / Description	List Price	
231643	(42204) 1980A-SS	\$28.59	FO-1002000

Marpac Lube Cap



- Protection against damage from water and dirt entering the wheel bearings.
- Automatically maintains the correct internal pressure.
- Sold per pair.

Order No.	Description	List Price	
7-59061	1.980"	\$9.29	GO-2260000

Marpac Lube Grommet



- Rubber grommet for use with bearing protectors.
- Sold per pair.

Order No.	Description	List Price	
7-59062	1.980"	\$4.49	GO-1030000

Bearing Buddy® - Chrome Plated



- Chrome plated.
- Prevents wheel bearing failure by keeping water and dirt out of hubs.
- Fits 1.980" bore hole diameter.

Order No.	Mfg. No. / Description	List Price	
231630	(42102)	\$22.09	FO-6451000

Bearing Buddy® Bras



- A vinyl cover that fits over the Bearing Buddy to contain excess grease and keep it off tires and wheels.
- The Bearing Buddy's automatic pressure relief feature will allow the excess grease to escape if the hub is overfilled.
- While trailering, this grease can be thrown onto wheels.
- Can be easily removed for checking hub lubricant level.

Order No.	Mfg. No. / Description	List Price	
231528	(70017) Fits 1781, 1810	\$3.19	FO-3220000
231530	(70019) Fits 1938, 1968, 1980, 2047, 2080	\$3.19	FO-3220000
231531	(70023) Fits 2240, 2328, 2441, 2562, 2717	\$3.19	FO-3220000

Dexter Super Lube Dust Cap



- Replacement Super Lube dust caps with removable rubber grommets.
- Zinc plated.
- Sold per pair.

Order No.	Mfg. No. / Description	List Price	
578369	(K71-G01-71) Cap Size: 2"	\$12.29	F0-0680000
578370	(K71-G01-72) Rubber Grommets	\$4.79	F0-5330000

Posi-Lube Lubed Dust Cap



- Sold each.

Order No.	Mfg. No. / Description	List Price	
2004706	(DC-200L) 2" Lubed Dust Cap	\$1.09	H0-5600000
2004707	(DC-300) Cap and Plug	\$3.09	H0-5810000
2004708	(DC-RP) Rubber Plug Only	\$1.19	H0-1700000

Dexter Lucas Marine Grease



- A premium, heavy duty lithium complex NLGI GC-LB Certified grease formulated with a unique additive system designed to provide maximum lubrication under the most severe marine operating conditions.
- A true marine grease with applications in trailer wheel bearing, trailer chassis lubrication, automotive wheel bearings and outboards.

Order No.	Mfg. No. / Description	List Price	
570633	(11008) 14 oz. Tubes (Case of 10)	\$12.19	F0-3580000

Aqua Lube Wheel Bearing and Chassis Grease



- A NLGI #2 grade of grease.
- Manufactures to be the finest custom made grease you can buy today, fortified with additives to protect against rust, corrosion, oxidation and wear.
- Aqua Lube is a non-melting, custom built grease that protects even against salt water.

Order No.	Mfg. No. / Description	List Price	
299012	(AL3336) 3 Pack of 3 oz. Cart.	\$8.49	F0-4950000
299010	(AL 1450) 14.5 oz. Cartridge	\$7.29	F0-0150000
299014	(AL 1624) 16 oz. Tub	\$9.09	F0-6360000
299001	(AL-0035) 5 Gallon Pail	\$196.19	F0-3373100

Dexter Metal Dust Cap



- Standard metal replacement dust caps fit most hubs and integral hub brake assemblies with an opening of 2".
- Zinc plated.
- Sold per pair.

Order No.	Mfg. No. / Description	List Price	
661333	(K71-314-04)	\$4.59	F0-1230000

Fulton Grease Caps



Order No.	Mfg. No. / Description	List Price	
6830011	(100235) 2.333"	\$5.59	F0-1930000
6830012	(001520) 2.446"	\$2.29	F0-0610000

Sierra Pro Performance Grease



- Specifically formulated for marine applications.
- Premium lithium formulation for optimum corrosion protection in freshwater and saltwater applications.
- Ideal for marine trailer wheel bearing, universal joints and outdrive pivot joints.
- Operating temperature: -40° F - 350° F.

Order No.	Mfg. No. / Description	List Price	
451524	(18-9200-4) 3 oz. Cartridge (4 Per Pack)	\$19.39	Z0-3531000
1892000	(18-9200-0) 8 oz. Tube	\$7.49	Z0-0540000
1892001	(18-9200-1) 15 oz. Cartridge	\$8.49	Z0-6350000

CorrosionX Grease



- A high performance, multi-purpose, extreme pressure rated NLGI #2 grade premium grease.
- Suitable for the toughest marine environments.
- Engineered for maximum shear stability, film strength and heavy shock-load performance, CorrosionX Grease offers unsurpassed wear and extreme pressure protection.
- Over-based calcium sultanate complex thickener maximizes pumpability, water resistance and high drop point.
- Superior anti-wear additives lubricate and prevent wear.
- Synergistic corrosion inhibitors protect against rust and corrosion.

Order No.	Mfg. No. / Description	List Price	
302965	(96801) 15 oz. Tube	\$16.29	F0-0411000



SPECIAL HANDLING MAY APPLY



- Electronics
- Trolling Motors
- Instruments
- Electrical
- Lighting
- Anchor & Dock
- Safety
- Steering, Controls
- Pumps
- Fuel System
- Seating & Pedestals
- Trailer
- Tops & Covers
- Perform.
- Propellers
- Engine & Care
- Cleaning & Care
- Paint & Paint Acc.
- Fun & Flotation
- Topside Acc.
- Cockpit & Deck
- Hardware, Fasteners
- Camouflage
- Misc.
- Comm.

Star Brite Wheel Bearing Grease



- Superior rust and corrosion protection from salt water, salt air and atmospheric chemicals.
- Special water-insoluble formula is highly resistant to wash-out.
- NLGI #2.
- Recommended for corrosive marine applications - trailer wheel bearings, water pumps, hinges, pins, winches and anchor chain reels.

Order No.	Mfg. No. / Description	List Price	
451725	(26003) 2 Pack of 3 oz. Cartridge	\$9.79	GO-6560000
451726	(26014) 14 oz. Cartridge	\$6.59	GO-2440000
451738	(26016) 1 lb. Tub (16 oz.)	\$7.29	GO-8840000

Sierra Grease Guns

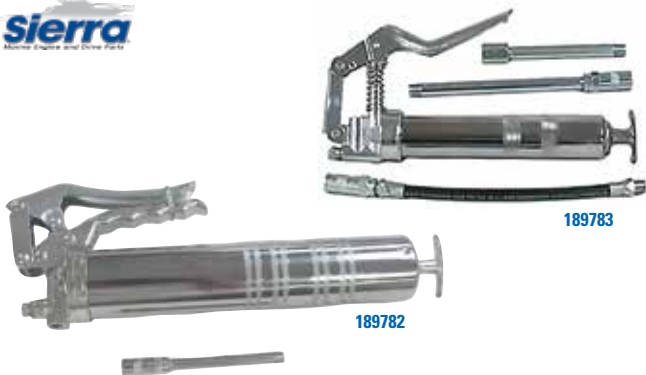

- Heavy duty all steel construction for dependable, long service life.

Order No.	Mfg. No. / Description	List Price	
189783	(18-9783) For 3 oz. Cartridges	\$39.49	ZO-5432000
189782	(18-9782) For 14 oz. Cartridges	\$35.49	ZO-1112000

Star Brite Lever Action Grease Gun



- Corrosion-resistant finish.
- Lever action for maximum pressure per stroke.
- Ideal for all marine, auto and home lubrication tasks.
- Accepts 14 oz. refill cartridges.
- Fits standard zerk fittings.

Order No.	Mfg. No. / Description	List Price	
451501	(028704)	\$20.89	GO-0041000

Star Brite Extension Hose for 14 oz. Grease Gun



- This flexible nozzle will fit most grease guns on the market.
- Made especially for gun 451598 (28714) and 451500 (28703).

Order No.	Mfg. No. / Description	List Price	
451600	(28800)	\$9.09	GO-9060000

Sta-Lube Sta-Plex™ Premium Red Grease



- Premium red grease with heavy duty lubricant that withstands high temperature and high pressure.
- Red color allows for easy visual inspection of film coverage.

Order No.	Mfg. No. / Description	List Price	
289144	(SL3192) 11 oz.	\$10.19	GO-3860000

Sierra Easy Luber



- Ideal for quick and easy lube jobs using squeeze tubes.
- Compact size, perfect for under seat and tackle box storage.
- Use with all 10 oz. gear lube tubes.

Order No.	Mfg. No. / Description	List Price	
451574	(18-9785)	\$29.49	ZO-0271000

Star Brite Standard Duty Pistol Grease Gun



- Can be used one-handed.
- Accepts 14 oz. refill cartridges.
- Corrosion-resistant finish.
- Fits standard zerk fittings.

Order No.	Mfg. No. / Description	List Price	
451599	(028724)	\$24.69	GO-4561000

Star Brite Lever Action Grease Gun



- Corrosion resistant bright metal finish.
- Lever action grease gun for use with all 14 and 14.5 oz. grease cartridges.
- Flexible nozzle 451600 (028800) available for hard to reach fittings.
- Heavy gauge steel barrel helps prevent dents, promoting longer life.

Order No.	Mfg. No. / Description	List Price	
451598	(28714)	\$24.69	GO-4561000

Star Brite Pistol Grease Gun with 3 oz. Cartridge



- Contains lube gun and 3 oz. cartridge of marine wheel bearing grease.
- Nozzle can be removed and flexible nozzle 451600 (028800) installed.
- Convenient, one hand application heavy duty design for years of trouble-free use.

Order No.	Mfg. No. / Description	List Price	
451500	(28703)	\$30.39	GO-6302000

Electronics

Trolling Motors

Instruments

Electrical

Lighting

Anchor & Dock

Safety

Steering, Controls

Pumps

Fuel System

Seating & Pedestals

Trailer

Tops & Covers

Perform.

Propellers

Engine & Care

Cleaning & Care

Paint & Paint Acc.

Fun & Flotation

Topside Acc.

Cockpit & Deck

Hardware, Fasteners

Camouflage

Misc.

Comm.

Dexter Stainless Steel Rotor Disc Brakes

Dexter Stainless Steel Rotor Disc Brake Assembly with Integral Hub



- Stainless steel rotor disc brake assembly with integral hub.
- Stainless steel rotors provided additional corrosion protection in harsh salt water environments.
- Features included are: 380 Aluminum calipers with E-coat finish.
- Aluminum calipers dissipate heat up to 5 times faster than cast iron calipers.
- Bi-metal pistons with a stainless steel piston cup.
- Long life ceramic brake pads with stainless steel backing plates.
- Ceramic pads eliminate the dust commonly associates with disc brakes.
- Integral hub has GalvX finish for added corrosion protection.
- For use on 1-3/8 X 1-1/16 tapered spindles.
- 5 Stud with 5 on 4.5 bolt pattern.
- Brake line and brake assembly mounting hardware included.

Order No.	Mfg. No. / Description	List Price	
657322	(K71-G00-42) 10"	\$288.49	F0-4910200
657325	(K71-G00-43) 12"	\$389.99	F0-9927200

Dexter Complete 10" Stainless Steel Rotor with Integral Hub Disc Brake System



- Kit comes with everything needed to replace or upgrade the hydraulic brake system on your trailer from drum brakes to vented rotor disc brakes.
- Includes model 660 disc brake actuator, brake lines for a single axle trailer and two 10" stainless steel rotor disc brake assemblies with integrated hubs.
- For use on 1-3/8" x 1-1/16" tapered spindles.
- 5 stud with 5 on 4.5 bolt pattern.
- The stainless steel rotor and GalvX finish on the integrated hub provide corrosion protection.
- Aluminum Caliper and 2 piece piston dissipate heat faster.
- Actuator feature Drop N Go Auto Latch Coupler.

Order No.	Mfg. No. / Description	List Price	
570636	(82404) 10"	\$954.89	F0-2486600

Dexter Vented Rotor Disc Brakes

Dexter Vented Disc Brake Assemblies with Integral Hub



- A vented rotor disc brake assembly with integral hub.
- Vented rotors and aluminum caliper assemblies allow heat to dissipate quickly to maintain optimum braking performance and efficiency.
- Ceramic brake pads with stainless steel backing plates eliminate the dust commonly associates with disc brakes.
- Vented rotor and Vortex hub have GalvX finish providing enhanced corrosion protection.
- Triple lip seal and Lucas Red N Tacky grease are used in each rotor/hub assembly.
- Caliper mounting bracket and hardware included

10" VENTED ROTOR DISC BRAKE ASSEMBLY

- For use on 1-3/8" x 1-1/16" tapered spindles.
- 5 stud with 5 on 4.5 bolt pattern.

Order No.	Mfg. No. / Description	List Price	
657104	(K71-G00-98)	\$226.09	F0-6285100

12" VENTED ROTOR DISC BRAKE ASSEMBLY

- For use on 1-3/4" x 1-1/4" tapered spindles.
- 6 stud with 6 on 5.5 bolt pattern.

Order No.	Mfg. No. / Description	List Price	
570651	(K71-G00-97) 12"	\$253.59	F0-1577100

Dexter Complete Vented Rotor with Integral Hub Disc Brake System



- Kit comes with everything needed to replace or upgrade the hydraulic brake system on your trailer from vent rotor disc brakes.
- Includes disc brake actuator, brake lines for a single axle trailer and two vented rotor disc brake assemblies with integrated hubs.
- Integrated hub and rotor feature GalvX finish for added corrosion protection.
- Vented Rotor, Aluminum Caliper and 2 piece piston dissipate heat faster.
- Actuator feature Drop N Go Auto Latch Coupler.

WITH MODEL 660 DISC BRAKE ACTUATOR

- For use on 1-3/8" x 1-1/16" tapered spindles.
- 5 stud with 5 on 4.5 bolt pattern.

Order No.	Mfg. No. / Description	List Price	
570639	(K71-G00-31) 10"	\$817.19	F0-3027500

WITH MODEL 800 DISC BRAKE ACTUATOR

- For use on 1-3/4" x 1-1/4" tapered spindles.
- 6 stud with 6 on 5.5 bolt pattern.

Order No.	Mfg. No. / Description	List Price	
570642	(K71-G00-37) 12"	\$981.89	F0-2378600

- Electronics
- Trolling Motors
- Instruments
- Electrical
- Lighting
- Anchor & Dock
- Safety
- Steering, Controls
- Pumps
- Fuel System
- Seating & Pedestals
- Trailering
- Tops & Covers
- Perform.
- Propellers
- Engine & Care
- Cleaning & Care
- Paint & Paint Acc.
- Fun & Flotation
- Topside Acc.
- Cockpit & Deck
- Hardware, Fasteners
- Camouflage
- Misc.
- Comm.

Dexter Complete Hydraulic Brake Line Kits



657106

- Includes all the parts and hardware needed to install or replace the brake lines for a trailer.

FOR A SINGLE AXLE TRAILER

- Includes: (1) 240" brake line with male end connectors, (1) 76" brake line with male end connectors, (2) 24" brake lines with male end connectors, (2) three hole female T's, (1) T plug, (2) T clamps, (4) cable clamps, (8) #10 self tapping screws and (5) 15" cable ties.

Order No.	Mfg. No. / Description	List Price	
657106	(K71-G02-58)	\$109.79	FO-5867000

FOR TANDEM AXLE TRAILER WITH BRAKES ON BOTH AXLES

- Includes: (1) 240" brake line with male end connectors, (2) 76" brake line with male end connectors, (1) 38" brake line with male end connectors, (4) 24" brake lines with male end connectors, (4) three hole female T's, (1) T plug, (4) T clamps, (6) cable clamps, (14) #10 self tapping screws and (9) 15" cable ties.

Order No.	Mfg. No. / Description	List Price	
657108	(80328)	\$183.09	FO-6182100

Dexter Organic Eliminator Vented Rotor Disc Brake Pads



- Replacement organic disc brake pads for Eliminator Vented Rotor brakes.
- Includes two inner and two outer brake pads.

Order No.	Mfg. No. / Description	List Price	
5765117	(K71-G00-21)	\$61.89	FO-2334000

Dexter Add An Axle Hydraulic Brake Line Kit



- Provides the parts to add brakes to a second axle using the single axle brake line kit 657106 (80326) or to a third axle using the tandem axle brake line kit 657108 (80328).

- Includes: (1) 76" brake line with male end connectors, (1) 38" brake line with male end connectors, (2) 24" brake lines with male end connectors, (2) three hole female T's, (1) T plug, (2) T clamps, (2) cable clamps, (6) #10 self tapping screws and (4) 15" cable ties.

Order No.	Mfg. No. / Description	List Price	
5765038	(80327)	\$75.49	FO-4825000

Dexter Hydraulic Brake Actuators



657301



570648

- Features the Drop N Go Auto Latch Coupler that will auto-latch onto the hitch ball when set on top of the hitch, with minimal weight and effort.
- Solenoid plumbing built into the master cylinder allowing for easier and faster maintenance service.
- Product mounts on a 3" tongue, 2" ball.
- Cast steel ball clamp, grease fittings on roller pin, stainless steel safety pin that locks the ball clamp in place and vinyl coated, self coiling emergency stop cable.
- Aluminum master cylinder with wide fill cap.

MODEL 660 BRAKE ACTUATORS - 6,600 LB. CAPACITY

Order No.	Mfg. No. / Description	List Price	
657300	(K99-066-20) Disc Brake Actuator with Solenoid	\$294.39	FO-7060200
657301	(K99-066-00) Drum Brake Actuator	\$263.09	FO-6148100

MODEL 800 BRAKE ACTUATORS - 8,500 LB. CAPACITY

Order No.	Mfg. No. / Description	List Price	
570645	(K99-Z85-00) Drum Brake Actuator	\$385.39	FO-7796200
570648	(K99-Z85-20) Disc Brake Actuator with Solenoid	\$418.79	FO-5139200

Dexter 24" Flexible Hydraulic Brake Line Kit



- Designed for use with Tie Down Engineering disc brakes to transition from rigid metal brake lines to the floating caliper assembly used on disc brake assemblies.
- 2 brake lines and (2) female/female brass fittings included.
- Use on trailers with metal brake lines.

Order No.	Mfg. No. / Description	List Price	
657227	(81099)	\$54.29	FO-0083000

Dexter 10" Hydraulic Drum Brake Assembly with GalvX Finish



- Kit includes left and right side drum brake assemblies.
- Assemblies feature corrosion resistant aluminum wheel cylinders, stainless steel springs and a GalvX finish.
- Brake pads are bonded and fastened with bronze rivets to backing plate.
- Mounting hardware is included.

Order No. Mfg. No. / Description List Price
657320 (K71-G01-01) **\$262.69** F0-8838100

Dexter Drum Hub



- Hubs are designed to work with hydraulic or electric drum brakes.
- Painted brake drum hubs for greater corrosion resistance.
- Brake drum hub only, with cups and studs.

Order No. Mfg. No. / Description List Price
657310 (K08-517-90) 10" **\$109.59** F0-1767000

Dexter Drum Brake Accessories



REPLACEMENT WHEEL CYLINDER KIT FOR HYDRAULIC DRUM BRAKES

- Includes: One each left hand and right hand wheel cylinder.

Order No. Mfg. No. / Description List Price
5765040 (K71-G02-55) For 10" & 12" Hydraulic Drum Brakes **\$82.09** F0-6475000

10" DRUM BRAKE REPLACEMENT SHOE LINING KIT

- Includes: front and rear shoes for both left and right sides.

Order No. Mfg. No. / Description List Price
5765071 (K71-G02-02) For 10" Hydraulic Drum Brake **\$70.09** F0-6094000

CRC Brakleen® Brake Parts Cleaner



- Formulated to quickly and effectively remove grease, brake dust, brake fluids, oils and other contaminants from brake parts, lining, pads.
- For: ABS, disc, drum, brake cylinders, brake drums, brake linings, brake shoes, calipers, clutch discs, disc brake pads, discs.
- Safe for use on all brake systems including: Springs & Wedge brakes.

Order No. Mfg. No. / Description List Price
2899068 (05089) 19 oz. **\$6.99** G0-8640000

Dexter Hydraulic Drum Brake Flush Kit



- Stop saltwater corrosion of drum brake components.
- This kit adapts to all hydraulic drum brake trailers and is easy to install and easy to use.
- One flush kit is required per axle.
- Includes: Tubing, drum brake assembly connectors and mounting clips.

Order No. Mfg. No. / Description List Price
5765070 (K71-G02-67) **\$76.79** F0-5735000

Dexter Reverse Lock Out Solenoid (Disc or Drum Brake Compatible)



- If your actuator does not have a reverse lock out lever or switch, a reverse lockout solenoid should be installed in the brake line before installation of disc brakes.
- Can be used with most hydraulic brake actuators.

Order No. Mfg. No. / Description List Price
657203 (K68-539-00) **\$61.99** F0-9334000

Penray Non-Chlorinated Brake Cleaner



- Low V.O.C. formula.
- Quickly and effectively dissolves and removes grease, oil, brake fluid and other contaminants from brakes, C.V. joints and clutch components.
- Helps stop brake squealing and can improve braking performance.

Order No. Mfg. No. / Description List Price
604320 (4620) 14 oz. **\$5.49** G0-8630000

CRC Brakleen® Brake Parts Cleaner - Non-Chlorinated



- Formulated to quickly remove brake fluid, grease, oil and other contaminants from brake linings & pads.
- For: ABS, discs, drum, brake cylinders, brake drums, brake linings, brake shoes, calipers, clutch discs, disc brake pads.
- Safe for use on all brake systems including: Springs & Wedge brakes.

Order No. Mfg. No. / Description List Price
2899066 (05084) 14 oz. **\$5.89** G0-5930000

- Electronics
- Trailering
- Trolling Motors
- Instruments
- Electrical
- Lighting
- Anchor & Dock
- Safety
- Steering, Controls
- Pumps
- Fuel System
- Seating & Pedestals
- Trailering
- Tops & Covers
- Perform.
- Propellers
- Engine & Care
- Cleaning & Care
- Paint & Paint Acc.
- Fun & Flotation
- Topside Acc.
- Cockpit & Deck
- Hardware, Fasteners
- Camouflage
- Misc.
- Comm.

- Electronics
- Trolling Motors
- Instruments
- Electrical
- Lighting
- Anchor & Dock
- Safety
- Steering, Controls
- Pumps
- Fuel System
- Seating & Pedestals
- Trailer**
- Tops & Covers
- Perform.
- Propellers
- Engine & Care
- Cleaning & Care
- Paint & Paint Acc.
- Fun & Flotation
- Topside Acc.
- Cockpit & Deck
- Hardware, Fasteners
- Camouflage
- Misc.
- Comm.

Trailer Springs



Slipper Spring - Flat End



Slipper Spring - Radius End



Double Eye Spring

* The capacities given are for reference, only. The actual capacity is dependent on the spring mounting (center clamp) and service requirements.

SLIPPER SPRING - FLAT END

DMI #	MFG #	Leaf Springs	Length	Capacity	List Price	
667898	(UNA-267)	3	24-1/2"	850 lbs.	\$30.89	FO-2612000
667886	(UNA-043)	4	24-1/2"	1,000 lbs.	\$37.99	FO-9562000
667901	(UNA-013)	2	25-1/8"	470 lbs.	\$23.79	FO-5661000
667913	(UNA-014)	3	25-1/8"	705 lbs.	\$32.09	FO-6422000
667925	(UNA-015)	4	25-1/8"	940 lbs.	\$38.89	FO-2272000
667937	(UNA-016)	5	25-1/8"	1,184 lbs.	\$47.99	FO-9533000
667949	(UNA-017)	6	25-1/8"	1,415 lbs.	\$55.49	FO-4883000
668028	(UNA-038)	2	30"	880 lbs.	\$42.49	FO-4792000
668030	(UNA-039)	3	30"	1,430 lbs.	\$51.29	FO-0953000
668054	(UNA-040)	4	30"	1,837 lbs.	\$66.69	FO-8664000

SLIPPER SPRING - RADIUS END

DMI #	MFG #	Leaf Springs	Length	Capacity	List Price	
667874	(UNA-034)	3	32"	800 lbs.*	\$44.89	FO-2413000
668131	(UNA-024)	4	32"	1,100 lbs.*	\$50.79	FO-5553000
668155	(UNA-029)	5	32"	1,400 lbs.*	\$62.39	FO-7634000

DOUBLE EYE SPRING

DMI #	MFG #	Leaf Springs	Length	Capacity	List Price	
668206	(UNA-219)	3	25-1/4"	1,250 lbs.*	\$31.89	FO-2322000
668220	(UNA-212)	4	25-1/4"	1,830 lbs.*	\$40.89	FO-2682000
668207	(UNA-220)	3	25-1/4"	2,000 lbs.*	\$38.39	FO-7862000
668205	(UNA-218)	4	25-1/4"	2,500 lbs.*	\$47.29	FO-0133000

Dexter Trailer Springs



- Replacement trailer springs: Heavy duty spring steel.
- Includes: 9/16" ID nylon bushings.

SLIPPER SPRINGS - RADIUS END

- 24-5/8" end to end. Arch depth 4". Arch length 23-1/2". Bulk.

Order No.	Mfg. No. / Description	List Price	
5765089	(072-161-00) 500# Capacity (Per Spring)	\$34.59	FO-1242000
5765090	(072-160-00) 1,000# Capacity (Per Spring)	\$44.99	FO-9413000

Dexter Shackle Link



- Steel shackle links are used to mount double eye springs.
- Suitable for medium duty axles, 1,000 lb. - 3,500 lb. capacity.
- Predrilled for 9/16" bolt.

Order No.	Mfg. No. / Description	List Price	
578194	(K71-G01-64)	\$4.89	FO-2430000

Dexter Rear Spring Hanger



- Solid steel hangers can be used on rear slipper springs 1-3/4" to 2" wide.
- 5,200 lb. to 8,000 lb. capacity, medium duty axles.
- 1/4" stock.

Order No.	Mfg. No. / Description	List Price	
578181	(86275)	\$4.19	FO-3920000

Dexter Front Spring Hanger



- Solid steel stock hangers for use on slipper and double eye springs that are mounted on 1,000 lb. - 3,500 lb. capacity, medium duty axles.
- Predrilled for 9/16" bolt.

Order No.	Mfg. No. / Description	List Price	
578166	(86274)	\$4.19	FO-3920000

SPECIAL HANDLING MAY APPLY



Dexter Spring Bushings



- Steel spring bushings.
- Dimensions: 2" length, 19/32" ID, 3/4" OD.
- Packed 10 to a poly bag. Sold each.

Order No.	Mfg. No. / Description	List Price	
5765092	(81190)	\$2.79	F0-5910000

Tie Down Fluted Shackle Bolt with Nut



- Zinc plated Grade 5 steel.
- For use with spring hanger brackets.
- Fluting prevents the bolt from turning, which can wear hanger brackets.
- 9/16" x 3" bolts with nuts.
- Sold 2 per pack.

Order No.	Mfg. No. / Description	List Price	
578368	(86250)	\$6.79	F0-5740000

Dexter Axle Tie Plate Kits



576516

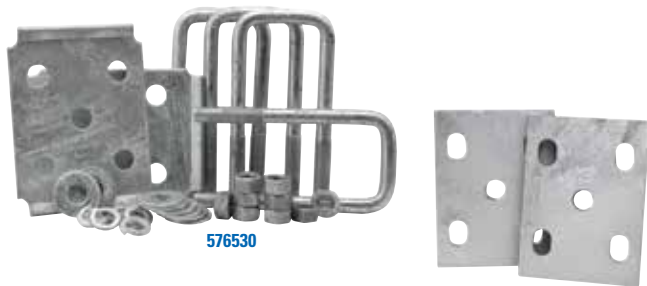

576530



576554

- Galvanized plate finish.
- Kits include: (4) U-bolts, (8) lock washers, (8) flat washers, (8) hex nuts and (2) five hole tie plates.

Order No.	Mfg. No. / Description	List Price	
576504	(K71-G01-52) Fits 1.90" Round Axles	\$29.39	F0-7502000
576516	(81180) Fits 2-3/8" Round Axles	\$37.79	F0-5462000
576530	(81185) Fits 2" Square Axles	\$45.79	F0-5023000

UNIVERSAL AXLE TIE PLATES - GALVANIZED

- Plate designed to fit 1.90", 2" and 2-3/8" wide square and round axle bolt patterns.
- Sold per pair.

Order No.	Mfg. No. / Description	List Price	
576554	(K71-G01-55)	\$11.59	F0-1180000

Spring Bushings

667850



667862



Order No.	Mfg. No.	List Price	
667850	(PE-182) End	\$2.09	F0-6410000
667862	(PE-224) Center	\$1.19	F0-3800000

Dexter Trailer Axle Spindles



580147

580111



580173



- Features stainless steel wear sleeve.
- Includes: Nut, washer and cotter pin.

Order No.	Mfg. No.	Bearing Surface	List Price	
580111	(K71-G01-90) 1-1/4" x 7"	1"	\$23.09	F0-6161000
580123	(K71-G01-89) 1-1/4" x 7"	1-1/16"	\$24.89	F0-2471000
580147	(K71-G03-07) 1-3/4" x 8-1/4"	1-1/16" x 1-3/8"	\$34.39	F0-7042000
580159	(K71-G01-91) 2" x 8-1/4"	1-1/16" x 1-3/8"	\$36.09	F0-6252000
580173	(K71-G01-50) Nut, Washer and Cotter Pin Kit		\$6.19	F0-3340000

- Electronics
- Trolling Motors
- Instruments
- Electrical
- Lighting
- Anchor & Dock
- Safety
- Steering, Controls
- Pumps
- Fuel System
- Seating & Pedestals
- Trailering
- Tops & Covers
- Perform.
- Propellers
- Engine & Care
- Cleaning & Care
- Paint & Paint Acc.
- Fun & Flotation
- Topside Acc.
- Cockpit & Deck
- Hardware, Fasteners
- Camouflage
- Misc.
- Comm.



Saltwater Exclusive



Freshwater Exclusive

Americana Tire and Wheel Assemblies

Americana Galvanized Plain Wheel



Americana Galvanized Mod Wheel



BIAS PLY TRAILER TIRE

Order No.	Mfg. No.	Size		Lugs	List Price	
505202	(30010)	480/400-8	8"	4 Ply 4	\$41.39	FO-4933000
505214	(30030)	480/400-8	8"	4 Ply 5	\$48.49	FO-4933000
505457	(3H440)	205/65-10	10"	8 Ply 5	\$148.09	FO-6630100

BIAS PLY TRAILER TIRE

Order No.	Mfg. No.	Size		Lugs	List Price	
505350	(3S430)	ST205/75D-14	14"	C Ply 5	\$159.19	FO-3411100
505355	(3S570)	ST215/75D-14	14"	C Ply 5	\$179.19	FO-3452100

RADIAL PLY TRAILER TIRE

Order No.	Mfg. No.	Size		Lugs	List Price	
505193	(32188)	ST215/75R-14	14"	C Ply 5	\$207.19	FO-3054100

Americana Galvanized Spoke Wheel



Americana Galvanized Plain Wheel - Wide Profile Tire



BIAS PLY TRAILER TIRE

Order No.	Mfg. No.	Size		Lugs	List Price	
505240	(30550)	480-12	12"	4 Ply 4	\$78.99	FO-9255000
505252	(30590)	480-12	12"	4 Ply 5	\$78.99	FO-9255000
505264	(30710)	530-12	12"	4 Ply 4	\$90.29	FO-0236000
505276	(30750)	530-12	12"	4 Ply 5	\$90.29	FO-0236000
505288	(3S040)	ST175/80D-13	13"	B Ply 4	\$118.39	FO-7828000
505303	(3S160)	ST175/80D-13	13"	C Ply 5	\$115.09	FO-6508000
505308	(31242)	ST175/80D-13	13"	D Ply 5	\$135.99	FO-9159000
505305	(3S334)	ST185/80D-13	13"	D Ply 5	\$146.29	FO-0420100
505339	(3S450)	ST205/75D-14	14"	C Ply 5	\$146.89	FO-2820100
505341	(3S650)	ST205/75D-15	15"	C Ply 5	\$155.29	FO-0780100
505358	(3S865)	ST225/75D-15	15"	D Ply 5	\$197.89	FO-2583100
505400	(3S880)	ST225/75D-15	15"	D Ply 6	\$183.99	FO-9782100

BIAS PLY TRAILER TIRE

Order No.	Mfg. No.	Size		Lugs	List Price	
506344	(3H490)	205/65-10	10"	10 Ply 5	\$143.09	FO-6100100

RADIAL PLY TRAILER TIRE

Order No.	Mfg. No.	Size		Lugs	List Price	
505192	(32156)	ST205/75R-14	14"	C Ply 5	\$195.89	FO-2173100

Americana Silver Mod Wheel



Americana Steel Directional Wheel



BIAS PLY TRAILER TIRE

Order No.	Mfg. No.	Size		Lugs	List Price	
506350	(3S967)	ST175/80D-13	13"	C Ply 5	\$127.99	FO-9598000

RADIAL PLY TRAILER TIRE

Order No.	Mfg. No.	Size		Lugs	List Price	
505168	(31986)	ST185/80R-13	13"	C Ply 5	\$145.29	FO-0710100
505170	(32194)	ST215/75R-14	14"	C Ply 5	\$199.69	FO-8793100

SPECIAL HANDLING MAY APPLY



- Electronics
- Trolling Motors
- Instruments
- Electrical
- Lighting
- Anchor & Dock
- Safety
- Steering, Controls
- Pumps
- Fuel System
- Seating & Pedestals
- Trailer
- Tops & Covers
- Perform.
- Propellers
- Engine & Care
- Cleaning & Care
- Paint & Paint Acc.
- Fun & Flotation
- Topside Acc.
- Cockpit & Deck
- Hardware, Fasteners
- Camouflage
- Misc.
- Comm.



Freshwater Exclusive



Saltwater Exclusive

Tire and Wheel Assemblies

727

Trailer

Americana Tire and Wheel Assemblies

Americana Chrome Directional Wheel



BIAS PLY TRAILER TIRE

Order No.	Mfg. No.	Size		Lugs	List Price	
5050050	(175X13-5-CD)	ST175/13	13" C Ply	5	\$135.09	F0-6549000

Americana Painted White Mod Wheel with Stripe



BIAS PLY TRAILER TIRE

Order No.	Mfg. No.	Size		Lugs	List Price	
5050130	(30582)	480-12	12" 4 Ply	5	\$77.89	F0-2545000
505100	(30831)	530-12	12" 6 Ply	5	\$90.89	F0-2545000
506340	(3S052)	ST175/80D-13	13" B Ply	5	\$117.29	F0-0128000
506338	(3S470)	ST205/75D-14	14" C Ply	5	\$148.49	F0-4930100

Americana Painted White Plain Wheel



BIAS PLY TRAILER TIRE

Order No.	Mfg. No.	Size		Lugs	List Price	
505012	(30000)	480/400-8	8" 4 Ply	4	\$41.39	F0-7982000
505024	(30020)	480/400-8	8" 4 Ply	5	\$41.39	F0-7982000
505036	(30080)	570-8	8" 4 Ply	4	\$58.59	F0-1014000
505048	(30100)	570-8	8" 4 Ply	5	\$58.59	F0-1014000
506351	(3H390)	205/65-10	10" 6 Ply	5	\$109.19	F0-3467000
505166	(3H430)	205/65-10	10" 8 Ply	5	\$129.99	F0-9909000

Tracker Tire and Wheel Assembly



Order No.	Mfg. No. / Description	List Price	
5050270	(3H453)	\$113.09	F0-6197000

Americana Chrome Mod Wheel



BIAS PLY TRAILER TIRE

Order No.	Mfg. No.	Size		Lugs	List Price	
7000470	(3S460)	ST205/75D-14	14" C Ply	5	\$194.79	F0-5363100

Americana Painted White Spoke Wheel with Stripe



BIAS PLY TRAILER TIRE

Order No.	Mfg. No.	Size		Lugs	List Price	
505062	(30540)	480-12	12" 4 Ply	4	\$77.89	F0-2545000
505074	(30580)	480-12	12" 4 Ply	5	\$77.89	F0-2545000
505086	(30700)	530-12	12" 4 Ply	4	\$86.79	F0-5706000
505098	(30740)	530-12	12" 4 Ply	5	\$86.79	F0-5706000
505102	(30820)	530-12	12" 6 Ply	5	\$93.29	F0-0356000
505125	(3S030)	ST175/80D-13	13" B Ply	4	\$117.29	F0-0128000
505137	(3S050)	ST175/80D-13	13" B Ply	5	\$117.29	F0-0128000
506354	(3S440)	ST205/75D-14	14" C Ply	5	\$148.49	F0-4930100
5050265	(3S640)	ST205/75D-15	15" C Ply	5	\$147.49	F0-4230100

Americana Painted White Plain Wheel - Wide Profile Tire



BIAS PLY TRAILER TIRE

Order No.	Mfg. No.	Size		Lugs	List Price	
506353	(3H480)	205/65-10	10" 10 Ply	5	\$134.09	F0-6839000
506355	(3H390)	205/65-10	10" 6 Ply	5	\$103.99	F0-9727000



SPECIAL HANDLING MAY APPLY



www.repuestoselnavegante.com

El Navegante

Electronics

Trolling Motors

Instruments

Electrical

Lighting

Anchor & Dock

Safety

Steering, Controls

Pumps

Fuel System

Seating & Pedestals

Trailer

Tops & Covers

Perform.

Propellers

Engine & Care

Cleaning & Care

Paint & Paint Acc.

Fun & Flotation

Topside Acc.

Cockpit & Deck

Hardware, Fasteners

Camouflage

Misc.

Comm.



Americana Tire and Wheel Assemblies

Americana Painted White Rims - ONLY



Eight Spoke Painted White Rim

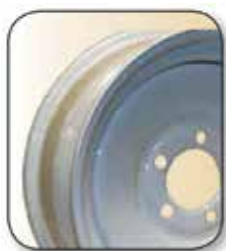

Solid Center Painted White Rim

SOLID CENTER PAINTED WHITE RIM

Order No.	Mfg. No.	Rim Size	Lugs	Capacity	List Price	
5050225	(20006)	8 x 3.75	5	900	\$16.69	F0-8611000
5050080	(20046)	10 X 6	5	1,725	\$32.39	F0-7622000

EIGHT SPOKE PAINTED WHITE RIM WITH STRIPS

Order No.	Mfg. No.	Rim Size	Lugs	Capacity	List Price	
506141	(20232)	13 x 4.5	5	1,725	\$38.79	F0-5172000

Americana Trailer Tires - ONLY



KENDA LOADSTAR TIRE

Order No.	Mfg. No.	Size	Ply	Capacity	List Price	
505606	(10002)	4.80/4.00-8	B	590	\$30.09	F0-6012000
5050195	(10012)	570-8	C	910	\$53.19	F0-3273000
506349	(1HP52)	205/65-10	C	1,100	\$80.59	F0-1465000
505620	(10060)	480-12	B	785	\$47.99	F0-9533000
505632	(10066)	530-12	C	1,045	\$60.89	F0-2624000
505656	(1ST76)	ST175/80D13	C	1,360	\$83.29	F0-0385000
506347	(1ST86)	ST205/75D14	C	1,760	\$106.89	F0-2847000
505670	(1ST96)	ST225/75D15	D	2,540	\$138.39	F0-7869000

KENDA KARRIER ST RADIAL TIRE

Order No.	Mfg. No.	Size	Ply	Capacity	List Price	
5050040	(10234)	ST205/75R14	C	1,760	\$147.79	F0-5430100
5050045	(10244)	ST205/75R15	C	1,820	\$155.89	F0-2190100

Americana Galvanized Rims - ONLY



SOLID CENTER GALVANIZED RIM

Order No.	Mfg. No.	Rim Size	Lugs	Capacity	List Price	
506331	(20048)	10 x 6	5	1,725	\$44.89	F0-2413000

EIGHT SPOKE GALVANIZED RIM

Order No.	Mfg. No.	Rim Size	Lugs	Capacity	List Price	
506230	(20124)	12 x 4	4	1,250	\$35.69	F0-8942000
506254	(20224)	13 x 4.5	4	1,360	\$45.19	F0-3613000
506266	(20234)	13 x 4.5	5	1,725	\$45.19	F0-3613000
506305	(20354)	14 x 5.5	5	2,040	\$56.89	F0-2893000
506329	(20524)	15 x 6	5	2,150	\$69.79	F0-5884000

Marpac Lug Nuts and Lug Bolts



7-1855

• Sold 5 per card.

Order No.	Description	List Price	
7-1855	Lug Bolts 1/2"	\$8.29	G0-5550000
7-1853	Lug Nuts 1/2"	\$5.79	G0-8830000

Dexter Lug Nuts and Lug Bolts



5765084



- Zinc plated.
- 1/2"-20.
- Packed 5 to a package.

Order No.	Mfg. No. / Description	List Price	
5765084	(K71-G03-11) Lug Bolts	\$7.69	F0-8350000
5765085	(K71-G01-51) Lug Nuts	\$6.19	F0-3340000

Meguiar's Hot Shine™ Gloss Tire Coating



- Hot Shine's high gloss formula gives your tires a "wet-look" with a dark shine.
- By combining highly water-resistant polymers with antiozonant technology, Hot Shine keeps your tires looking blacker longer while preventing cracking, browning and premature aging.

Order No.	Mfg. No. / Description	List Price	
6270011	(G13815) 15 oz.	\$8.39	F0-7850000

SPECIAL HANDLING MAY APPLY



- Electronics
- Trolling Motors
- Instruments
- Electrical
- Lighting
- Anchor & Dock
- Safety
- Steering, Controls
- Pumps
- Fuel System
- Seating & Pedestals
- Trailerling
- Tops & Covers
- Perform.
- Propellers
- Engine & Care
- Cleaning & Care
- Paint & Paint Acc.
- Fun & Flotation
- Topside Acc.
- Cockpit & Deck
- Hardware, Fasteners
- Camouflage
- Misc.
- Comm.

Camco Wheel Chock



- Chocks keep your trailer in place so you can re-hitch with confidence.
- Solidly constructed of durable hard plastic with UV inhibitors.
- Comes with rope.

Order No.	Mfg. No. / Description	List Price
357079	(44472)	\$5.69 F0-8930000

Tie Down Plastic Fender - "SUV" Single



- The "SUV" style fenders are corrosion proof and impact resistant.
- Tie Down's injection molding process assures consistent quality of shape and finish.
- The modular design accommodates for 14-15 in. tires and wheels.
- Each kit contains necessary mounting hardware.

Order No.	Mfg. No. / Description	List Price
5765182	(86553) White	\$86.99 H0-9125000

Tie Down Plastic Fender



- Upgrade your trailer with these high impact polyethylene fenders.
- Plastic fenders are UV protected.
- Designed for normal and low profile tires.
- "No load" capacity and fit 8" to 12" wheels.
- Dimensions: 7-3/4" x 21" x 5".

Order No.	Mfg. No. / Description	List Price
657110	(17026) White	\$12.19 F0-3580000

Tie Down Step Bracket for Large Plastic Fenders

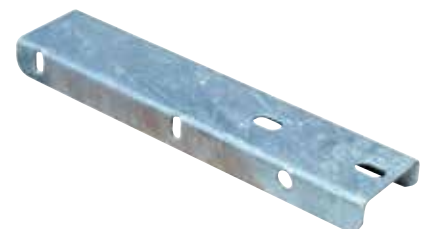

- Galvanized.
- Step bracket for large plastic fenders.
- Dimensions: 13.219" x 4.812" x 1.188".
- Sold each (1 per package).

Order No.	Mfg. No. / Description	List Price
657115	(44141)	\$9.89 F0-2960000

Carver Tire Cover



- A must for preventing weather-cracked spare trailer tires.
- Each tire cover has 1/4" strong and durable shock cord in the hem for convenient, easy installation and removal.
- Recommended for storage only.
- Haze Gray Performance Poly-Guard 100% marine grade polyester.
- Highest tear strength available. 8 oz, strong and durable.
- UV and mildew resistant. Excellent resistance to fading.
- Extremely water repellent.
- Breathable to help allow interior moisture to escape.
- Made in USA.
- Available in other colors or Sun-DURA as Special Orders.

Order No.	Mfg. No. / Description	Color	List Price
7000304	(TC13) For 13" Tires	Haze Gray	\$36.09 F0-6252000

Tie Down Galvanized Metal Fenders



- Heavy duty stamped fenders are made from 16 gauge galvanized steel.
- Fenders can be drilled to fit a variety of mounting options.
- Mounting brackets not included.

Order No.	Mfg. No.	Wheel Size	Dimensions	List Price
5765178	(86264)	8"	7" x 20" x 6"	\$15.79 F0-5011000
5765179	(86265)	12"	7" x 23.5" x 6.5"	\$16.59 F0-1611000
5765180	(86266)	13"	8" x 27.5" x 11"	\$22.39 F0-7651000
5765181	(86267)	14-15"	9" x 31.5" x 13"	\$26.89 F0-2881000

- Electronics
- Trolling Motors
- Instruments
- Electrical
- Lighting
- Anchor & Dock
- Safety
- Steering, Controls
- Pumps
- Fuel System
- Seating & Pedestals
- Trailering**
- Tops & Covers
- Perform.
- Propellers
- Engine & Care
- Cleaning & Care
- Paint & Paint Acc.
- Fun & Flotation
- Topside Acc.
- Cockpit & Deck
- Hardware, Fasteners
- Camouflage
- Misc.
- Comm.



SPECIAL HANDLING MAY APPLY



Tough Guy Spare Tire Carrier



- Heavy duty steel construction, hot dipped galvanized for long lasting protection.
- Fits most 4 and 5 lug tires.
- Attaches to any trailer frame 3" wide x 4" high.
- Easy to install.
- Zinc plated mounting hardware included.

Order No.	Description	List Price	Mfg. No. / Description
7-1755	Spare Tire Carrier	\$24.49	G0-1461000

Tie Down Side Mount Spare Tire Carrier

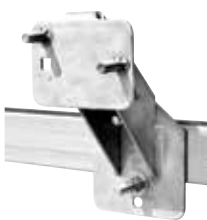

- Hot dip galvanized.
- Extra heavy duty welded steel construction.
- Adjustable bolt circle fits both 4 lug and 5 lug wheels.
- Fits all trailer tongues up to 3" wide by 4" high.
- Carriage bolts and lug nuts to mount tire to carrier are included.

Order No.	Mfg. No. / Description	List Price	Mfg. No. / Description
578306	(86098)	\$26.99	F0-9881000

Tie Down Spare Tire Carrier



- Hot dip galvanized.
- Heavy duty welded steel construction.
- Adjustable to fit 4, 5 and 6 lug wheels.
- Fits all trailer frames up to 8" high.
- Carriage bolts and lug nuts to mount tire to carrier are included.

Order No.	Mfg. No. / Description	List Price	Mfg. No. / Description
578283	(86069)	\$61.79	F0-5234000

Tough Guy Spare Tire Carriers



- Suitable for 4 or 5 hole rims.
- Will fit 8" through 14" and most 15" wheels.
- Heavy 7/16" U-bolt secures tire on tongue or frame up to 3" wide.
- Adjustable threaded brackets holds padlock for extra security.

Order No.	Description	List Price	Mfg. No. / Description
7-59100	With Lock	\$19.69	G0-9131000
7-59103	With Lock Brackets	\$9.69	G0-9460000
7-59104	With Nut, No Lock	\$9.89	G0-3660000

Tie Down High Mount Spare Tire Carrier



- Hot dip galvanized.
- Made of heavy duty steel tubing.
- Accommodates 4, 5 and 6 lug wheels.
- Fits all trailer frames up to 3" wide by 4" high.
- Carriage bolts and lug nuts to mount tire to carrier are included.

Order No.	Mfg. No. / Description	List Price	Mfg. No. / Description
578293	(86101)	\$41.89	F0-2392000

Tie Down Spare Hub and Tire Carrier

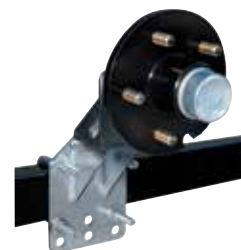

- Heavy duty zinc plated steel carrier mounts, both spare hub and spare tire.
- Includes 5 stud pre-greased hub with bearings.
- Designed for 1,750# hub with 1-1/16" and 1-3/8" bearings.
- Fits all trailer frames up to 3" wide and 4" high.

Order No.	Mfg. No. / Description	List Price	Mfg. No. / Description
578281	(86079)	\$85.79	F0-5006000

Fulton Spare Tire Carriers



- Zinc plated to resist corrosion.
- Heavy duty 1/2" diameter construction.
- Fits 8", 9", 12", 13", 14" and 15" wheels with 4 or 5 lug rims.
- Includes lug nuts to secure wheel to frame.
- Dimensions: 2" L x 5.5" W x 12" H.

Order No.	Mfg. No. / Description	List Price	Mfg. No. / Description
7000392	(ETC0101)	\$13.69	F0-8590000
333625	(ETCHL 0700) With Bracket	\$33.19	F0-3232000

Attwood U-Bolt Style Tire Carrier



- Zinc plated steel.
- Square bend U-bolt with bracket.
- Mounts tire on tongue or trailer frame.
- Fits 4 or 5 lug hole rims.
- The frame must be between 2" x 2" square to 3-1/2" x 4" rectangular in size.
- Extra long 8-1/2" shaft fits 8" to 15" tires.
- Note: Does not include padlock.

Order No.	Mfg. No. / Description	List Price	Mfg. No. / Description
333613	(11090-3)	\$9.19	F0-3460000

Tough Guy Poly Keel Rollers



- Made from a non-marring poly blend with UV inhibitors.
- Won't mark up the hull with ugly black streaks.
- 5/8" shaft.

Order No.	Description	List Price	
7-1580	Length 8"	\$20.49	G0-3731000
7-1581	Length 10"	\$21.49	G0-0441000
7-1582	Length 12"	\$23.99	G0-7061000

Tough Guy Poly Spool Rollers



- Made from a non-marring poly blend with UV inhibitors.
- Won't mark up the hull with ugly black streaks.
- 5/8" shaft.

Order No.	Description	List Price	
7-1570	Length 4"	\$6.29	G0-1240000
7-1571	Length 5"	\$7.39	G0-5940000

Tough Guy Poly Bow Stop Rollers



- Made from a non-marring poly blend with UV inhibitors.
- Won't mark up the hull with ugly black streaks.
- 1/2" shaft.

Order No.	Description	List Price	
7-1566	Width 3"	\$6.19	G0-5140000
7-1567	Width 4"	\$7.49	G0-2050000

Tough Guy Poly V-Bow Stop

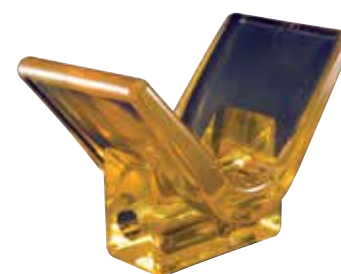

- Made from a non-marring poly blend with UV inhibitors.
- Won't mark up the hull with ugly black streaks.
- 1/2" shaft.

Order No.	Description	List Price	
7-1565	Length 3"	\$6.69	G0-8440000

Tough Guy Self-Centering Poly Keel Roller



- Made from a non-marring poly blend with UV inhibitors.
- Molded grooves center boat as it moves forward for easier loading.
- Replaces any 12" roller with 5/8" shaft.

Order No.	Description	List Price	
7-1583	Length 12"	\$24.29	G0-7261000

Tough Guy Poly Wobble Roller



- Made from a non-marring poly blend with UV inhibitors.
- Won't mark up the hull with ugly black streaks.
- 3/4" shaft.

Order No.	Description	List Price	
7-1575	4" x 3"	\$9.19	G0-6160000

Tough Guy Poly Bell Stop Assemblies

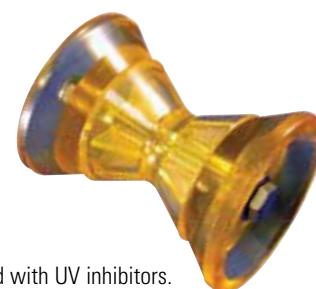

- Made from a non-marring poly blend with UV inhibitors.
- Won't mark up the hull with ugly black streaks.
- Stainless steel hardware.

Order No.	Description	List Price	
7-1560	Width 3"	\$16.99	G0-8311000
7-1561	Width 4"	\$22.59	G0-4151000

- Electronics
- Trolling Motors
- Instruments
- Electrical
- Lighting
- Anchor & Dock
- Safety
- Steering, Controls
- Pumps
- Fuel System
- Seating & Pedestals
- Trailer**
- Tops & Covers
- Perform.
- Propellers
- Engine & Care
- Cleaning & Care
- Paint & Paint Acc.
- Fun & Flotation
- Topside Acc.
- Cockpit & Deck
- Hardware, Fasteners
- Camouflage
- Misc.
- Comm.

- Electronics
- Trolling Motors
- Instruments
- Electrical
- Lighting
- Anchor & Dock
- Safety
- Steering, Controls
- Pumps
- Fuel System
- Seating & Pedestals
- Trailer
- Tops & Covers
- Perform.
- Propellers
- Engine & Care
- Cleaning & Care
- Paint & Paint Acc.
- Fun & Flotation
- Topside Acc.
- Cockpit & Deck
- Hardware, Fasteners
- Camouflage
- Misc.
- Comm.

Tough Guy Wobble Rollers

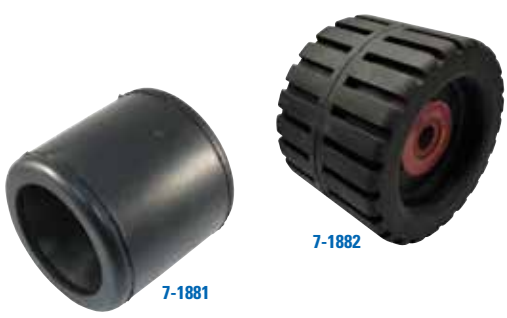

- Designed to wobble back and forth automatically adjusting to the contours of the boat hull.

SMOOTH WITH WASHER - 4-1/4" WIDTH

Order No.	Dimensions	List Price	
7-1881	4-1/4" OD, 7/8" ID	\$12.79	GO-7580000

THREAD WITH SLEEVE - 3" WIDTH

Order No.	Dimensions	List Price	
7-1882	Shaft Diameter 1/2"	\$7.99	GO-5350000

Tough Guy Side Guide Roller



- Black rubber.
- Helps center boat in non-drive-on applications.
- Prevents boat from damaging trailer fenders and light brackets.

Order No.	Dimensions	Shaft	List Price	
7-59514	Length 9", Diameter 2"	1/2"	\$11.19	GO-0570000
7-1883	Length 12", Diameter 2-1/2"	5/8"	\$12.69	GO-0580000

Tough Guy Spool Rollers



- Black rubber.
- Designed especially to support the keel of lighter boats.
- Maximum roller OD 3".

Order No.	Length	Shaft Diameter	List Price	
7-59508	4"	1/2"	\$5.99	GO-1040000
7-1874	4"	5/8"	\$5.19	GO-8430000
7-1873	5"	1/2"	\$6.39	GO-8240000
7-1875	5"	5/8"	\$5.89	GO-5930000

Tough Guy Shaft Spool/Bow Roller End Cap



- Durable black rubber end cap for standard duty use.
- | Order No. | Length | Shaft | List Price | |
|-----------|--------|-------|------------|------------|
| 7-59522 | 3.5" | 5/8" | \$4.19 | GO-1820000 |
| 7-59523 | 2" | 1/2" | \$2.79 | GO-7810000 |
| 7-59524 | 2.5" | 5/8" | \$3.29 | GO-0220000 |
| 7-59528 | 3" | 1/2" | \$2.99 | GO-0020000 |

Tough Guy Keel Rollers



- Black rubber with nylon bushings.
- Shaft diameter 5/8".
- Handles the added weight of heavier boats by properly fitting the curvature of the keel.
- Allows for easier launching and loading of the boat.
- Maximum roller OD 3-1/2".

Order No.	Dimensions	List Price	
7-1870	Length 8"	\$11.99	GO-3080000
7-1871	Length 10"	\$15.49	GO-8301000
7-1872	Length 12"	\$19.19	GO-6821000

Tough Guy Bow Roller



- Black rubber.
- Shaft diameter 1/2".
- Normally used on the trailer winch stand, this roller acts as a bow stop for the boat.
- Maximum roller OD 3".

Order No.	Dimensions	List Price	
7-1877	Length 3"	\$4.29	GO-7820000
7-59507	Length 4"	\$7.49	GO-2050000

Tough Guy Bow Guards - V-Block



- Black rubber.
- Shaft diameter 1/2".
- Attaching to the trailer's winch stand, these bow guards act as a stop to protect the boat's bow.

Order No.	Dimensions	List Price	
7-1878	2" x 2"	\$4.29	GO-7820000
7-1880	3" x 3"	\$7.49	GO-2050000
7-1879	3-3/4" x 4"	\$9.69	GO-9460000

Boater Sports Pool Rollers



- Durable black rubber bow guard for standard duty use.
- 1/2" shaft.

Order No.	Mfg. No. / Description	List Price
1-59510	(59510) Length 5"	\$10.09 H0-5060000

Tie Down Wobble Roller Kit



- 5" wobble roller kit.
- 7/8" and 1-1/8" shafts.

Order No.	Mfg. No. / Description	List Price
5765080	(86144) Amber PVC Rollers	\$53.09 F0-6173000
5765082	(86419) Black PVC Rollers	\$50.49 F0-4353000

Tie Down Wobble Roller Front Assembly

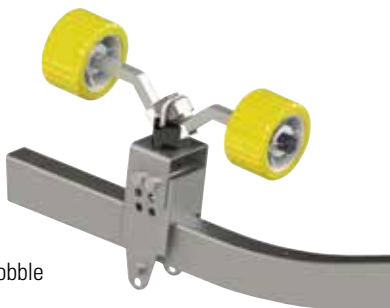

- The front assembly is designed to mount only 1 wobble roller wing set.
- The design features 2" of height adjust-ability and can fit onto either 3x3 or 3x4 cross-members.
- The assembly comes with wobble rollers and hardware.

Order No.	Mfg. No. / Description	List Price
5765079	(86574)	\$84.09 F0-6885000

Tie Down Pal/Cap Nuts



- Press on to secure shaft to roller bracket.
- Sold 4 per pack.

Order No.	Mfg. No. / Description	List Price
576958	(86305) 1/2" OD	\$3.39 F0-7320000
576960	(86310) 5/8" OD	\$4.39 F0-7030000

Boater Sports Bow Guard - V-Block



- Durable black rubber V-block for standard duty use.

Order No.	Mfg. No. / Description	List Price
1-59504	(59504) 5" H, 8.5" L	\$13.59 H0-5180000

Captain's Best Bow V-Roller Assembly



- Consists of: Side pieces are 2" x 3" 12" quarter inch aluminum angle.
- Side pieces are drilled for attachment with 3-1/8" U-bolts at various heights.
- Impact Vee is 1-1/4" schedule 40 aluminum tube welded to side pieces.
- Vee aluminum tubes are covered with 1-1/2" schedule 40 pvc pipe.
- Roller is a 12" yellow pvc keel roller.
- Roller shaft is galvanized 13-1/2" steel shaft with pal end caps.

Order No.	Description	List Price
7-1564	Bow V-Roller Assembly	\$151.19 G0-0310100

Tough Guy Galvanized Roller Shafts



- Galvanized for corrosion resistance.
- No pal nuts required.
- Includes: (2) zinc plated washers and stainless steel cotter pin.

Order No.	Description	List Price
7-1835	1/2" OD Length 5-1/4" Fits 4" Roller	\$2.69 G0-0810000
7-1836	1/2" OD Length 6-1/4" Fits 5" Roller	\$3.79 G0-4520000
7-1837	5/8" OD Length 5-1/4" Fits 4" Roller	\$4.69 G0-4130000
7-1838	5/8" OD Length 6-1/4" Fits 5" Roller	\$4.69 G0-4130000
7-1839	5/8" OD Length 9-1/4" Fits 8" Roller	\$5.89 G0-5930000
7-1840	5/8" OD Length 11-1/8" Fits 10" Roller	\$6.69 G0-8440000
7-1841	5/8" OD Length 13-1/2" Fits 12" Roller	\$7.99 G0-5350000

Tie Down Roller Shafts



- Zinc plated.
- Includes roller shaft and 2 pal/cap nuts.

Order No.	Mfg. No. / Description	List Price
5765127	(86028) Diameter 5/8" Length 6-1/4"	\$5.89 F0-2140000
5765128	(86032) Diameter 5/8" Length 15-1/4"	\$7.19 F0-3050000
5765129	(86033) Diameter 5/8" Length 19-1/4"	\$8.49 F0-4950000

- Electronics
- Trolling Motors
- Instruments
- Electrical
- Lighting
- Anchor & Dock
- Safety
- Steering, Controls
- Pumps
- Fuel System
- Seating & Pedestals
- Trailering
- Tops & Covers
- Perform.
- Propellers
- Engine & Care
- Cleaning & Care
- Paint & Paint Acc.
- Fun & Flotation
- Topside Acc.
- Cockpit & Deck
- Hardware, Fasteners
- Camouflage
- Misc.
- Comm.

Tough Guy Panel Brackets - Bulk



- Heavy 11 gauge hot dipped galvanized steel.
- One piece and designed to support keel rollers.
- Slots accept 7/16" or 1/2" diameter bolts and provide vertical roller adjustment.

Order No.	Description	List Price
7-1829	For 4" Roller	\$10.49
7-1830	For 5" Roller	\$11.89
7-1831	For 8" Roller	\$17.09
7-1832	For 10" Roller	\$15.79
7-1833	For 12" Roller	\$23.39

Tie Down Split Panel Bracket



- Hot dip galvanized for lasting protection.
- Designed to accommodate any size keel roller.
- Slots allow vertical adjustment for stabilizing the boat on trailer.
- Slots accept 7/16" or 1/2" bolts.
- Roller shaft diameter can be 1/2" or 5/8" roller shaft.
- Sold in pairs (left and right).

Order No.	Mfg. No. / Description	List Price
487581	(81235)	\$13.09

Tough Guy Bolster Brackets - Packaged

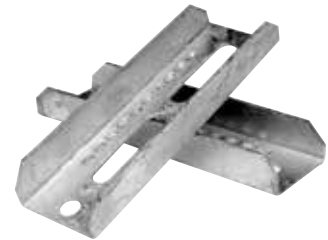

- Heavy 11 gauge hot dipped galvanized steel.
- Slotted for vertical adjustment and feature nonslip dimples to avoid movement and increase load capacity.
- Sold 2 per package with swivel brackets.

Order No.	Description	List Price
7-1820	Length 8" Slot Length 2-3/4"	\$19.99
7-1821	Length 10" Slot Length 3-3/4"	\$20.29
7-1822	Length 12" Slot Length 4-3/4"	\$25.09
7-1825	Angle Bracket - Pair	\$7.59

Tie Down Bolster Swivel Brackets



- Hot dip galvanized.
- Designed to support bunk boards.
- Slotted for vertical adjustment and feature non-slip dimples to avoid movement and increase load capacity.
- Packaged in pairs including swivel brackets, bolts and nyloc nuts.
- Slot length: 1-1/16".

Order No.	Mfg. No. / Description	List Price
5765099	(81210) Length 8"	\$11.29
5765100	(81215) Length 10"	\$13.99
5765101	(81220) Length 12"	\$16.29

Tough Guy Bunk Brackets



- Heavy 11 gauge hot dipped galvanized steel mount 2" bunks on edge.
- Slotted for vertical adjustment to standard or deep-V hulls.
- Sold per pair.

Order No.	Description	List Price
7-1815	Length 9-1/2"	\$15.09
7-1816	Length 12-5/8"	\$22.69

Tie Down Bolster Brackets

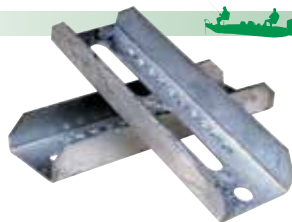

- Hot dip galvanized.
- Designed to support bunk boards.
- Slotted for vertical adjustment and feature non-slip dimples to avoid movement and increase load capacity.
- Slot: 1-1/16".

Order No.	Mfg. No. / Description	List Price
5765095	(81195) Length 8"	\$9.09

Tie Down Bunk Brackets



- Hot dip galvanized.
- Heavy 11 gauge steel brackets mount 2" bunks on edge.
- Slotted for vertical adjustment to standard or deep-V hulls.

Order No.	Mfg. No.	Bracket Length	Slot Length	Sold	List Price
577102	(86149)	8"	4-1/2"	Bulk	\$5.19
5765102	(81225)	9-1/2"	6"	2-Pack	\$15.79

- Electronics
- Trolling Motors
- Instruments
- Electrical
- Lighting
- Anchor & Dock
- Safety
- Steering, Controls
- Pumps
- Fuel System
- Seating & Pedestals
- Trailer
- Tops & Covers
- Perform.
- Propellers
- Engine & Care
- Cleaning & Care
- Paint & Paint Acc.
- Fun & Flotation
- Topside Acc.
- Cockpit & Deck
- Hardware, Fasteners
- Camouflage
- Misc.
- Comm.

Tie Down 5' Hull Sav'r Roller Bunk

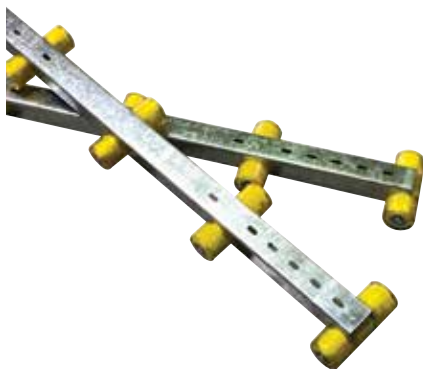

- Two heavy duty 5 foot galvanized steel frames provide full hull support using 5 sets of amber Hull Sav'r poly rollers for loads up to 1,500 lbs.
- Hull Sav'r rollers will not mark hull bottoms and have a limited lifetime warranty against cutting and fading.

Order No. Mfg. No. / Description List Price
578208 (86145) Length 5' **\$182.39** FO-7672100

Tie Down Hex Head Bolts



- Zinc plated Grade 5 steel.
- Used for mounting brackets, couplers and winch stands.
- Package contains: (4) Bolts, (4) washers and (4) nyloc nuts.
- 1/2" x 3-1/2".

Order No. Mfg. No. / Description List Price
580577 (86257) **\$9.59** FO-1760000

Flat Washers



- 5/8" . 1-1/2" OD. .078 thick.
- Sold in packs of 50.

Order No. Mfg. No. / Description List Price
730878 (B-194D) **\$36.59** H0-5912000

Tough Guy Galvanized U-Bolts

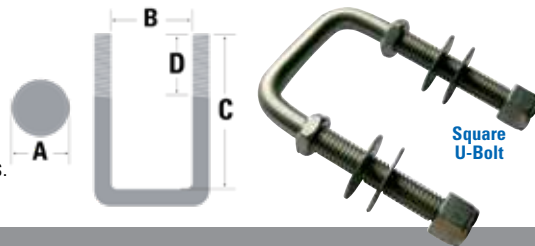

- Fully galvanized to protect against the elements.
- Includes: Galvanized nuts and washers.
- Sold per pair.

SQUARE U-BOLTS

Order No.	Thread Size (A)	Inside Width (B)	Length (C)	Thread Length (D)	List Price	
7-1794	3/8"	1-9/16"	2-5/8"	2"	\$8.69	GO-2850000
7-1776	3/8"	3-1/16"	2-3/8"	2"	\$9.49	GO-6360000
7-1772	3/8"	3-1/16"	4-1/2"	2"	\$8.69	GO-2850000
7-1764	1/2"	2-1/16"	4-3/16"	2"	\$8.89	GO-6950000
7-1792	1/2"	2-1/16"	4-13/16"	2"	\$8.89	GO-6950000
7-1768	1/2"	2-1/16"	5-3/16"	2"	\$8.89	GO-6950000
7-1788	1/2"	2-1/16"	5-1/2"	3"	\$8.89	GO-6950000
7-1802	1/2"	2-1/8"	4"	2"	\$8.89	GO-6950000
7-1759	1/2"	3-1/16"	4-3/16"	2"	\$8.89	GO-6950000
7-1774	1/2"	3-1/16"	5-3/16"	2"	\$8.19	GO-9450000
7-1789	1/2"	3-1/16"	6-3/16"	2"	\$8.89	GO-6950000
7-1804	1/2"	3-1/8"	3"	2"	\$8.89	GO-6950000
7-1806	1/2"	3-1/8"	4"	2"	\$8.89	GO-6950000
7-1808	1/2"	4-1/8"	3"	2"	\$8.89	GO-6950000

ROUND U-BOLTS

Order No.	Thread Size (A)	Inside Width (B)	Length (C)	Thread Length (D)	List Price	
7-1762	7/16"	2-1/2"	5-1/4"	2"	\$10.09	GO-6760000

Tie Down U-Bolt Kits

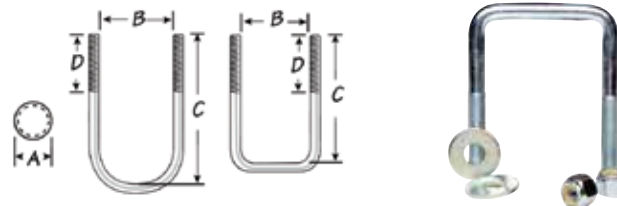

How to measure for U-Bolts:

- A = Rod Width - Threads Per Inch
- B = Between Leg Length (Inside Thread)
- C = Leg Length
- D = Thread Length

- Used for mounting brackets to trailer frame.

ZINC PLATED. INCLUDES FLAT WASHERS AND NYLOC NUTS.

Order No.	Mfg. No.	A	B	C	D	Shape	Sold	List Price	
5765156	(86212)	7/16"-14	1-9/16"	3-9/16"	2"	Square	Each	\$4.49	FO-4130000
5765172	(86228)	7/16"-14	2-1/16"	2-5/16"	1"	Square	Each	\$4.39	FO-7030000
5765173	(86229)	7/16"-14	2-1/16"	4-5/16"	2"	Square	Each	\$5.09	FO-6530000
5765174	(86230)	7/16"-14	3-1/16"	3-5/16"	1-3/4"	Square	Each	\$4.59	FO-1230000
5765175	(86231)	7/16"-14	3-1/16"	4-5/16"	2"	Square	Each	\$4.29	FO-0030000
5765176	(86234)	7/16"-14	4-1/16"	2-13/16"	1-3/4"	Square	Each	\$4.99	FO-9430000
5765160	(86216)	3/8"-16	1-3/4"	4-13/16"	1-3/4"	Round	Each	\$3.89	FO-2720000
5765163	(86219)	3/8"-16	1-5/8"	3-9/16"	1-3/4"	Square	Each	\$4.29	FO-0030000
5765152	(86208)	3/8"-16	2-1/8"	4"	1-3/4"	Square	Pair	\$8.69	FO-8060000
5765153	(86209)	3/8"-16	3-1/8"	3"	1-3/4"	Square	Pair	\$7.79	FO-5450000
5765154	(86210)	3/8"-16	3-1/8"	4"	1-3/4"	Square	Pair	\$7.99	FO-9550000
5765155	(86211)	3/8"-16	4-1/8"	3"	1-3/4"	Square	Pair	\$8.19	FO-3750000
5765159	(86215)	1/2"-13	2-1/16"	4-13/16"	2"	Square	Each	\$5.59	FO-1930000
5765148	(86204)	1/2"-13	2-1/8"	4"	2"	Square	Pair	\$7.89	FO-2550000
5765158	(86214)	1/2"-13	3-1/16"	3-13/16"	1-1/2"	Square	Each	\$5.19	FO-3630000
5765149	(86205)	1/2"-13	3-1/8"	3"	1-1/2"	Square	Pair	\$7.99	FO-9550000
5765150	(86206)	1/2"-13	3-1/8"	4"	2"	Square	Pair	\$8.39	FO-7850000
5765151	(86207)	1/2"-13	4-1/8"	3"	2"	Square	Pair	\$8.49	FO-4950000

HOT DIP GALVANIZED COATING. INCLUDES FLAT WASHERS, LOCK WASHERS AND NUTS.

Order No.	Mfg. No.	A	B	C	D	Shape	Sold	List Price	
5765168	(86224)	3/8"-16	1-3/4"	4-13/16"	1-3/4"	Round	Each	\$4.59	FO-1230000
5765167	(86223)	1/2"-13	2-1/16"	4-13/16"	2"	Square	Each	\$6.39	FO-7440000
5765166	(86222)	1/2"-13	3-1/16"	3-13/16"	1-1/2"	Square	Each	\$5.99	FO-9140000

- Electronics
- Trolling Motors
- Instruments
- Electrical
- Lighting
- Anchor & Dock
- Safety
- Steering, Controls
- Pumps
- Fuel System
- Seating & Pedestals
- Trailering
- Tops & Covers
- Perform.
- Propellers
- Engine & Care
- Cleaning & Care
- Paint & Paint Acc.
- Fun & Flotation
- Topside Acc.
- Cockpit & Deck
- Hardware, Fasteners
- Camouflage
- Misc.
- Comm.

Tough Guy Outboard Motor Lock



- Secures O/B motor to transom.
- Coated steel tube locks over the screws blocking access.
- Includes pad lock that fits inside tube.
- Keyed.

Order No.	Description	List Price	Mfg. No. / Description
7-52612	Outboard Motor Lock	\$23.99	GO-7061000

Fulton Outboard Motor Lock



- Fits most outboard motors secured to transom by clamp screws (except certain Chrysler Models).
- Long lasting, black powder-coat finish provides years of protection against rust and corrosion.
- Heavy duty barrel key lock mechanism for maximum security.
- Foam filler insert reduces noise and vibration.

Order No.	Mfg. No. / Description	List Price	Mfg. No. / Description
357562	(OML-0127)	\$43.79	FO-5603000

Attwood Swivl-Eze Lock N' Stow™



- Locks the outboard motor in the forward position while trailering, greatly reducing the damaging effects of road shock.
- Does not "tie" engine's lower-unit to trailer, eliminating excessive pressure on hydraulic seals and scuff marks.
- Small compact mount can be easily stored in just about any boat compartment.
- Constructed of black powder-coated steel with stainless steel pins.

FITS: MERCURY ENGINES

Order No.	Mfg. No. / Description	List Price	Mfg. No. / Description
587562	(10107)	\$122.09	FO-6458000

- Fits: 135 - 175 HP Optimax/Optimax ProXS and the 150 - 200 HP EFI.

Order No.	Mfg. No. / Description	List Price	Mfg. No. / Description
587564	(10108)	\$114.49	FO-4108000

FITS: OMC ENGINES

- Fits: OMC, Bombardier 1989 to present, 100 HP and up.

Order No.	Mfg. No. / Description	List Price	Mfg. No. / Description
5870013	(10309)	\$104.69	FO-8237000

REPLACEMENT BUSHINGS - SOLD EACH

Order No.	Mfg. No. / Description	List Price	Mfg. No. / Description
587568	(P10106)	\$5.59	FO-1930000

Sierra Trailing Clips



Order No.	Mfg. No. / Description	List Price	Mfg. No. / Description
189096	(18-9096) Fits: Volvo SX-A, DPS-A (2007-Up)	\$31.99	ZO-5191000
189098	(18-9098) Fits: All SX Models thru 2006	\$23.49	ZO-3041000

T-H Marine 4" Steer Stop Outboard Hydraulic Steering Lock



- Locks hydraulic steering when trailering.
- Fits most steering cylinder rods on outboard engines.
- Snaps over outboards hydraulic steering cylinder rods.
- Helps keep engine centered during transport.
- Protects steering system, outboard, and motor supports.
- Includes cord to connect units for storage and to aid in removal.
- Grip makes it even simpler and easier to put on and take off.

Order No.	Mfg. No. / Description	List Price	Mfg. No. / Description
640945	(SS-3-DP)	\$20.89	HO-3521000

T-H Marine Sterndrive Trailing Clips



- Provide an inexpensive way to protect sterndrive units while trailering or storing.
- Increases the life of the O-rings, internal seals and valve in the hydraulic system.
- Resistant to UV rays, gasoline, oil and other marine chemicals.
- Fits all sterndrives with 3/4" hydraulic rams.
- Sold per pair.

Order No.	Mfg. No. / Description	List Price	Mfg. No. / Description
6400285	(TC-1-DP) Length 12"	\$36.99	HO-9122000

Dometic Stabilizer Clips



- 4" long stabilizer clips for Dometic steering cylinders.
- Sold 2 per pack.

Order No.	Mfg. No. / Description	List Price	Mfg. No. / Description
841070	(HYCL-001)	\$12.39	FO-7680000

- Electronics
- Trolling Motors
- Instruments
- Electrical
- Lighting
- Anchor & Dock
- Safety
- Steering, Controls
- Pumps
- Fuel System
- Seating & Pedestals
- Trailer
- Tops & Covers
- Perform.
- Propellers
- Engine & Care
- Cleaning & Care
- Paint & Paint Acc.
- Fun & Flotation
- Topside Acc.
- Cockpit & Deck
- Hardware, Fasteners
- Camouflage
- Misc.
- Comm.

Tough Guy Engine/Trim Ram Mounted Transom Saver



- Quickly installs over the outboard trim ram.
- Minimizes the strain on the trim/tilt system.
- Relieves stress on the boats transom.
- Compatible with: Yamaha, Mercury, Evinrude/Johnson, Suzuki and Honda outboards.
- Prevents the outboard from slipping back into a vertical position.

Order No.	Description	List Price
7-59127	Sold Each	\$19.69

T-H Marine Motor Stik™ Outboard Motor Support



- Fits over Trim Rams.
- Supports your outboard while trailering.
- Takes the pressure off of hydraulic system.
- Most outboards 150 HP and up.
- Strong aluminum tubing with molded ends.
- Safe for salt or fresh water.

Order No.	Mfg. No. / Description	List Price
640664	(MSS-1-DP)	\$51.49

Sierra Trailering Sticks



- Fits most outboards over 150 HP with three ram integral tilt/trim.

Order No.	Mfg. No. / Description	List Price
1879989	(18-79989)	\$56.54

MotorMate Outboard Locking Systems

- Your outboard motor is a major investment and protecting it while transporting it to the water should be a top priority.
- Marine grade stainless steel with high impact nylon endcaps.
- The Motormate Mercury Locking System locks most Mercury 2-Stroke outboard, Yamaha outboard, Johnson/Evinrude 2-Stroke motors in place, preventing costly damage to your steering system and excess torque on your transom.
- The Motormate Locking System also releases pressure off your hydraulic system.
- Guy Eakers, Ott Defoe, Bryan Thrift, Randall Tharp, Aaron Martens, Timmy Horton and Jason Christie are just a few of the Elite Series, FLW, and MLF Pros who rely on Motormate Locking Systems to protect their motors and transoms when traveling across the Country.
- Please Note: Please measure the lower unit of your motor before purchase. Direct any questions to Motormate customer service: 1-844-668-6768



FOR MERCURY 2-STROKE 75-115 HP ENGINES

- Yoke: 3-7/16". Transom mount: 7-7/16".

Order No.	Mfg. No. / Description	List Price
209200	(10-201-SSB) Black	\$114.19
209202	(10-201-SSR) Red	\$114.19

FOR MERCURY 2-STROKE PROXS 125-175 HP, 150-200 HP EFI, 200 HP CARB

- Yoke: 3-1/8". Transom mount: 7-7/16".

Order No.	Mfg. No. / Description	List Price
209204	(10-202-SSB) Black	\$114.19
209206	(10-202-SSR) Red	\$114.19

FOR MERCURY 2-STROKE PROXS 225-300 HP, 225-250 HP EFI ENGINES

- Yoke: 4-9/16". Transom mount: 7-7/16".

Order No.	Mfg. No. / Description	List Price
209208	(10-203-SSB) Black	\$114.19
209210	(10-203-SSY) Yellow	\$114.19
209212	(10-203-SSR) Red	\$114.19

FOR YAMAHA 4-STROKE 115-175 HP (THROUGH 2014) ENGINES

- Yoke: 4-3/4". Transom mount: 8-1/4".

Order No.	Mfg. No. / Description	List Price
209220	(10-300-SSB) Black	\$145.99

FOR YAMAHA 4-STROKE 150 HP SHO MODELS

- Yoke: 4-3/4". Transom mount: 7-3/4".

Order No.	Mfg. No. / Description	List Price
209230	(10303ASHOSSB) Black	\$129.99

FOR JOHNSON/EVINRUDE 2-STROKE 85-250 HP (1991-10) ENGINES

- Yoke: 4-1/2". Transom mount: 6-1/4".

Order No.	Mfg. No. / Description	List Price
209214	(10-101-SSB) Black	\$114.19
209216	(10-101-SSR) Red	\$114.19

FOR JOHNSON/EVINRUDE E-TEC G2 225-300 HP, 200-250 HP H.O.

- Yoke: 7-1/2". Transom mount: 6-1/4".

Order No.	Mfg. No. / Description	List Price
209218	(10-102-SSB) Black	\$135.99

FOR YAMAHA 4-STROKE 200-250 HP SHO MODELS

- Yoke: 5-7/8". Transom mount: 7-3/4".

Order No.	Mfg. No. / Description	List Price
209224	(10303SHOSSB) Black	\$129.99
209226	(10303SHOSSY) Yellow	\$129.99
209228	(10303SHOSSR) Red	\$129.99

FOR YAMAHA 2-STROKE 200-250 HP (EXCLUDING 2000-04) ENGINES

- Yoke: 6". Transom mount: 8-1/4".

Order No.	Mfg. No. / Description	List Price
209222	(10-302-SSB) Black	\$145.99

- Electronics
- Trolling Motors
- Instruments
- Electrical
- Lighting
- Anchor & Dock
- Safety
- Steering, Controls
- Pumps
- Fuel System
- Seating & Pedestals
- Trailer
- Tops & Covers
- Perform.
- Propellers
- Engine & Care
- Cleaning & Care
- Paint & Paint Acc.
- Fun & Flotation
- Topside Acc.
- Cockpit & Deck
- Hardware, Fasteners
- Camouflage
- Misc.
- Comm.

Tough Guy Premier Motor Support Bracket



- Bolt-on or over-the-roller universal mount.
- Adjustable from 21" - 31".
- Indestructible polypropylene pads.
- Powder coated cast aluminum head and mounts are lightweight, durable and corrosion resistant.
- Easy-to-handle lightweight aluminum tubing will not rust.
- All stainless steel hardware and fasteners eliminate corrosion.
- EPDM rubber strap and stainless hooks included.

Order No.	Description	List Price	
7-0386	Motor Support Bracket	\$48.49	GO-9423000
7-0387	Spare Bracket Kit	\$10.29	GO-9860000

Tough Guy Shock Absorbing Transom Saver



- Shock absorbing spring reduces transom and engine stress.
- Adjusts easily from 20.5" to 31".
- Includes 100% EPDM strap.
- Heavy duty roller mount.
- Reinforced lower unit cradle.

Order No.	Description	List Price	
7-59123	Shock Absorbing Transom Saver	\$41.59	GO-7872000

Attwood Swivl-Eze Angled Transom Saver - Adjustable



- Innovative design fits most trailers.
- Unique angle adjustments (patent pending) from 0° to 36° in 12° increments.
- Heavy duty rubber pads prevent scratching on the lower unit.
- Corrosion resistant black finish.
- Head type: Heavy duty.
- Mounting bracket: Trailer mount.

Order No.	Mfg. No. / Description	List Price	
512030	(460-ADJ) Adjusts from 36" to 60"	\$150.89	FO-2650100

Attwood Swivl-Eze Heavy Duty Transom Savers - Adjustable



- Support the cantilevered weight of the motor.
- Stabilize engine and steering mechanism when trailering.
- Head type: Heavy duty.

Order No.	Mfg. No.	Mounting Bracket	Adjusts from	List Price	
587786	(4000-ADJ)	Roller	24" - 36"	\$59.29	FO-0514000
5870039	(4000-ADJ-B)	Trailer Mount	24" - 36"	\$59.29	FO-0514000
587709	(424-ADJ)	Roller	32" - 44"	\$67.39	FO-7174000
587760	(436-ADJ)	Roller	44" - 56"	\$70.99	FO-9694000

REPLACEMENT PARTS

Order No.	Mfg. No. / Description	List Price	
5870076	(SP-402) Bolt On Bracket	\$21.19	FO-3841000
5870077	(SP-410) Rubber Shocks for Heavy Duty Head	\$9.89	FO-2960000
587710	(SP-416) Toggle for Heavy Duty Head	\$11.19	FO-3870000

Tough Guy Transom Saver - Dual Mount



- Comes with over the roller and bolt-on brackets for mounting to trailer.
- Made of coated steel.
- Basic adjustable: 32" - 40".
- 10" Rubber strap included.

Order No.	Description	List Price	
7-59118	Transom Saver - Dual Mount	\$32.59	GO-4812000

Attwood Swivl-Eze Adjustable Transom Saver



- Support the cantilevered weight of the motor.
- Stabilize engine and steering mechanism when trailering.
- Head type: Composite.
- Mounting bracket: Roller/trailer mount.
- Sold each per skin pack.

Order No.	Mfg. No. / Description	List Price	
587708	(SP-400-RB) Adjusts from 23" to 35"	\$54.59	FO-1283000